

# Techn. Data / Daten: Pihasauna Piha-Tuuri 7

Log length (W x D) / Bohlenaußenmaß (B x T): 234 x 344 cm

Wall size(outside) / Wandaußenmaß: 214 x 324 cm

Log thickness / Bohlenstärke: 70 mm



234

344

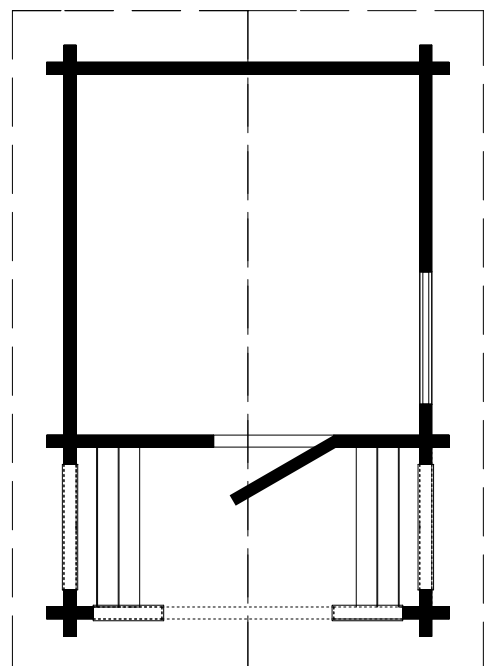

Note: All dimensions are approximate ! / Achtung : Alle angegebenen Maße sind ca. - Maße !

# Pihasauna Piha-Tuuri 7 - 70 mm / 234 x 344 cm

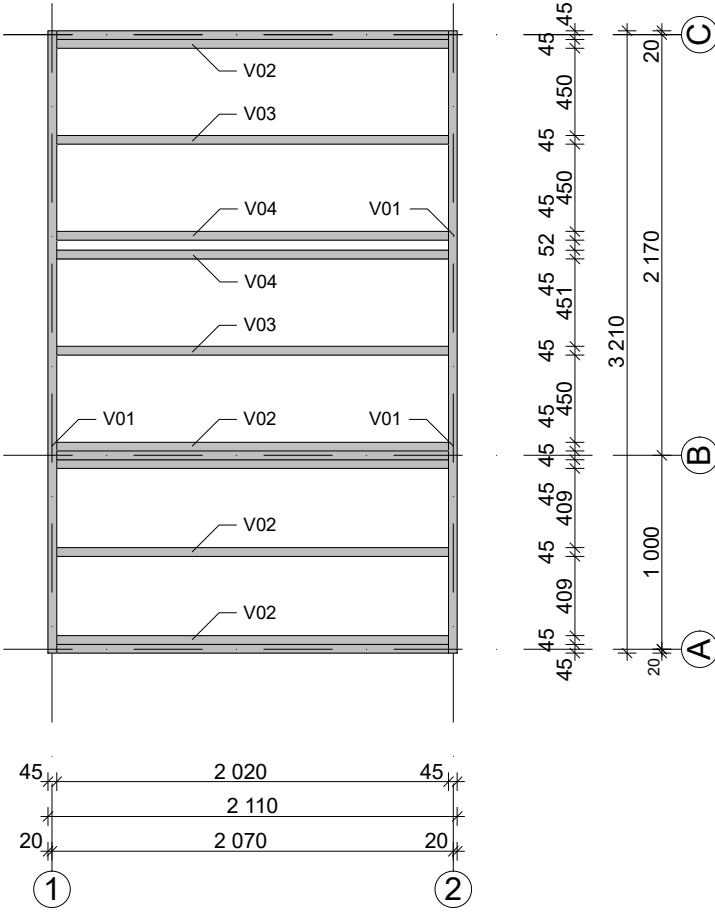

# Pihasauna Piha-Tuuri 7 - 70 mm / 234 x 344 cm

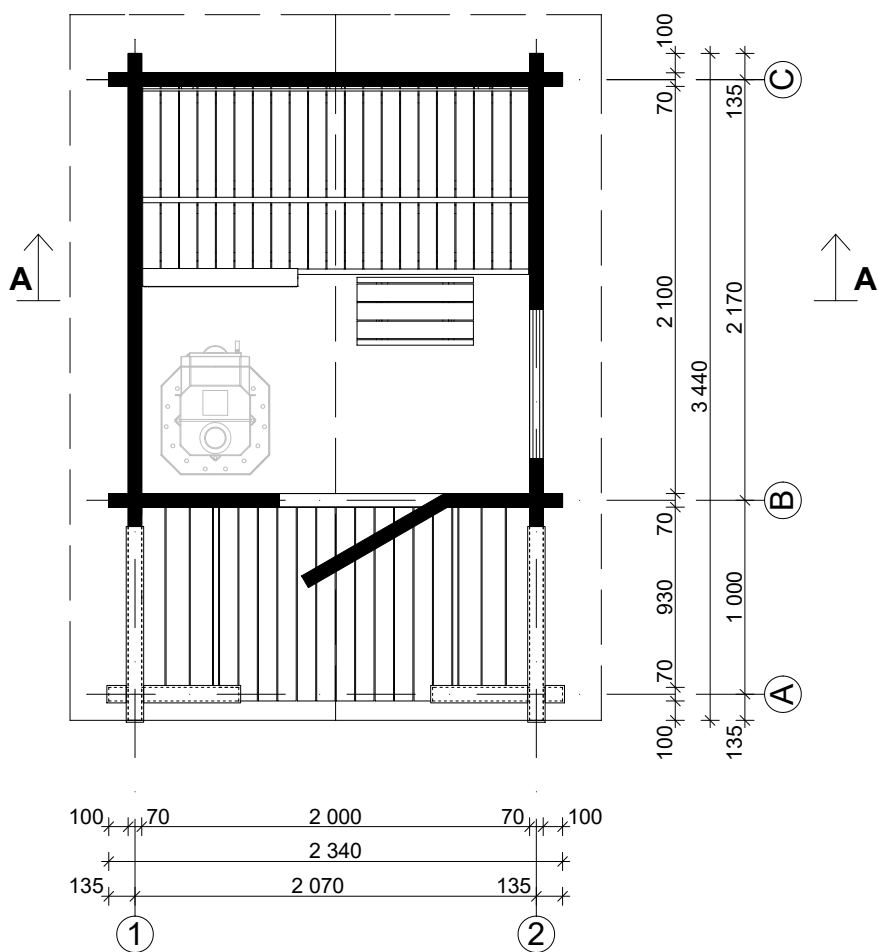

# Pihasauna Piha-Tuuri 7 - 70 mm / 234 x 344 cm

## Roof / Dach

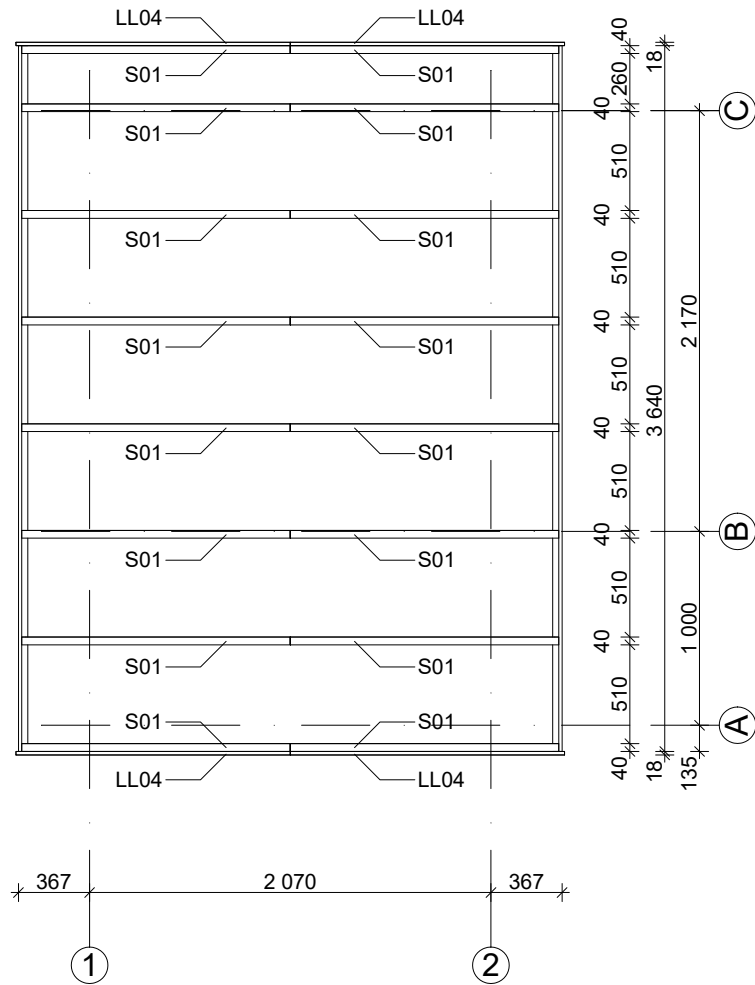

# Pihasauna Piha-Tuuri 7 - 70 mm / 234 x 344 cm - A; B

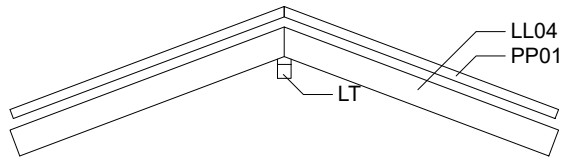

1

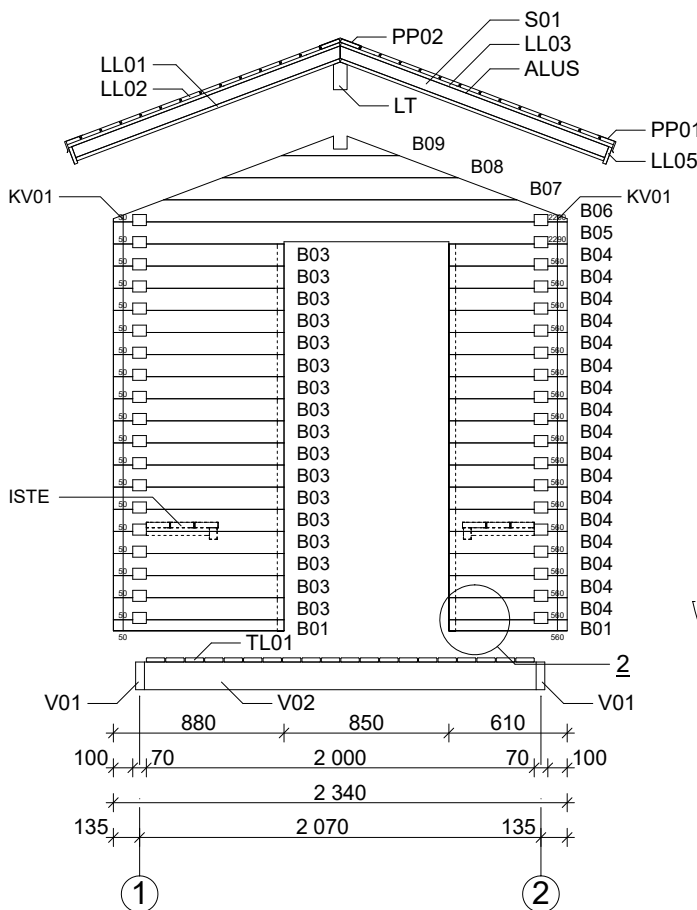
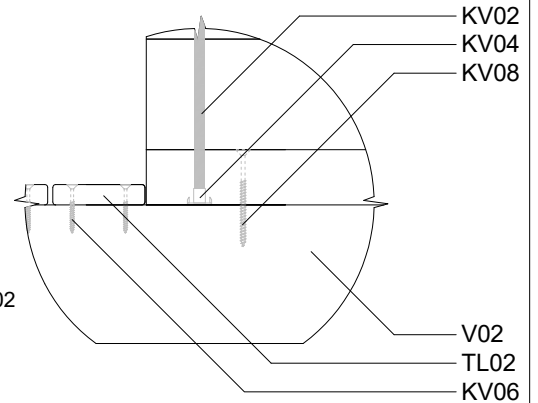
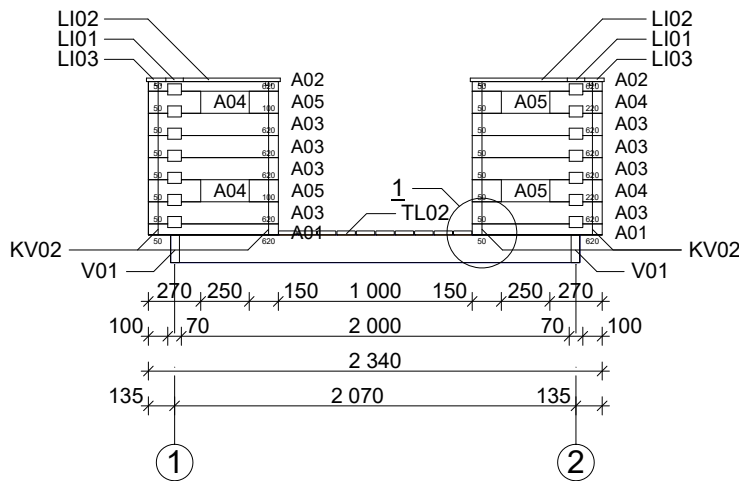

2

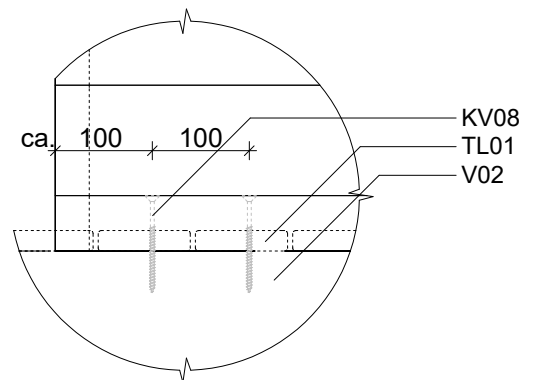

# Pihasauna Piha-Tuuri 7 - 70 mm / 234 x 344 cm - C; 1

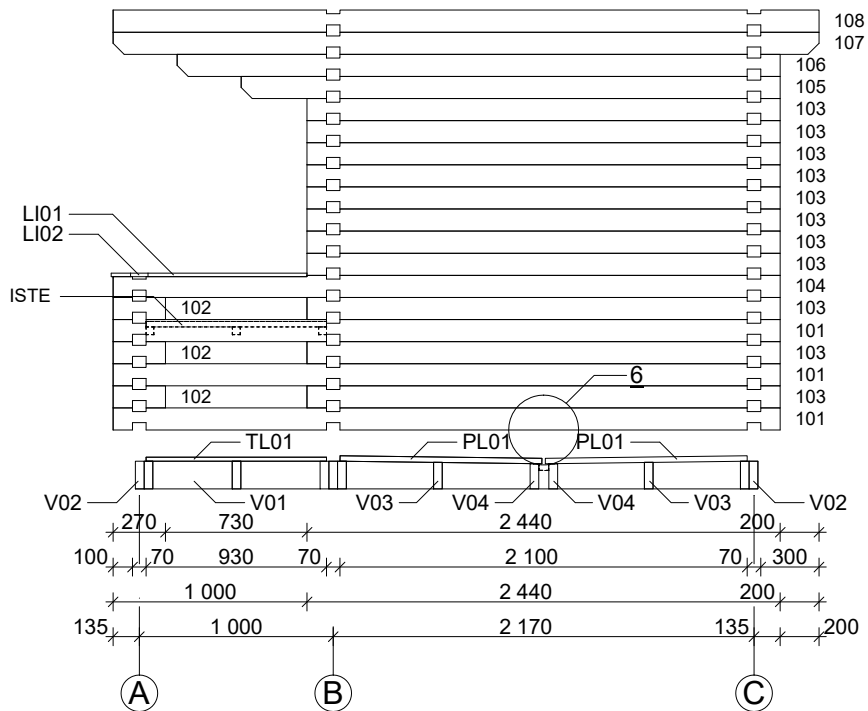
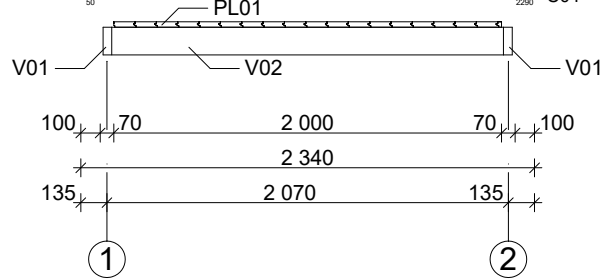
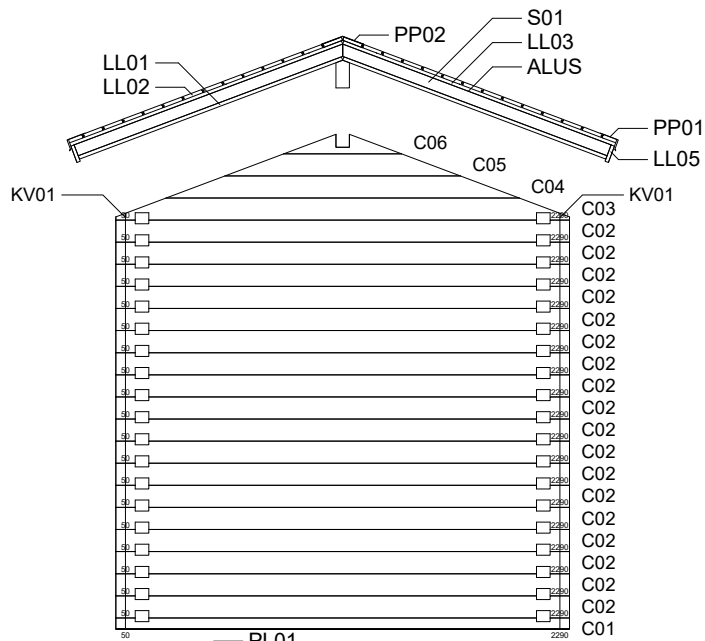

# Pihasauna Piha-Tuuri 7 - 70 mm / 234 x 344 cm

3

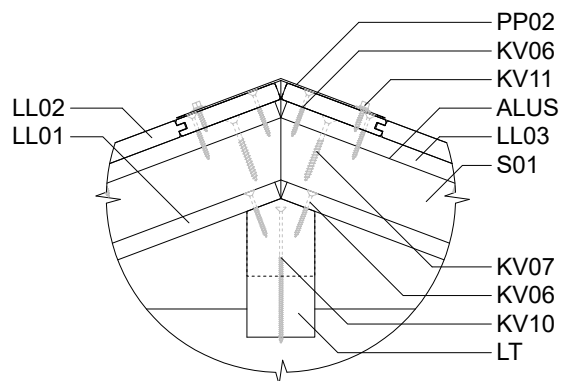

4

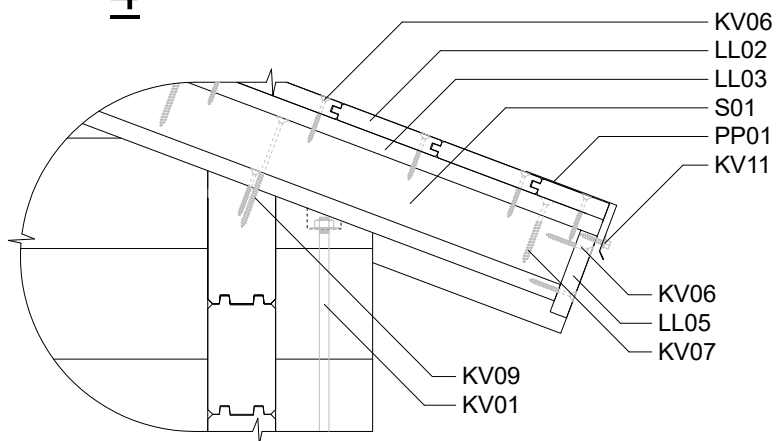

5

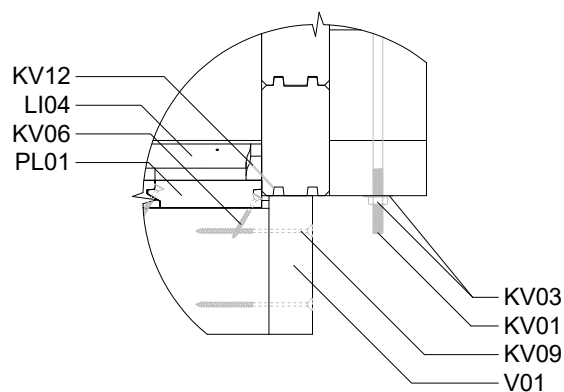

6

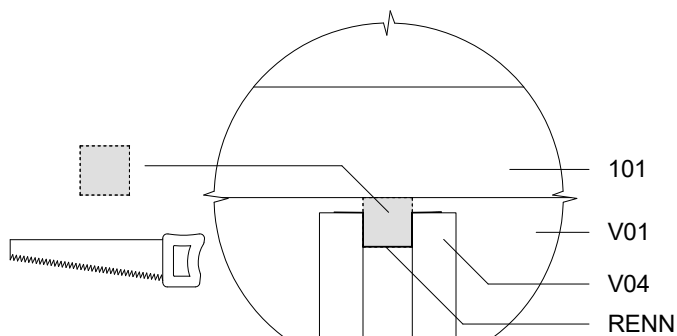

B-B

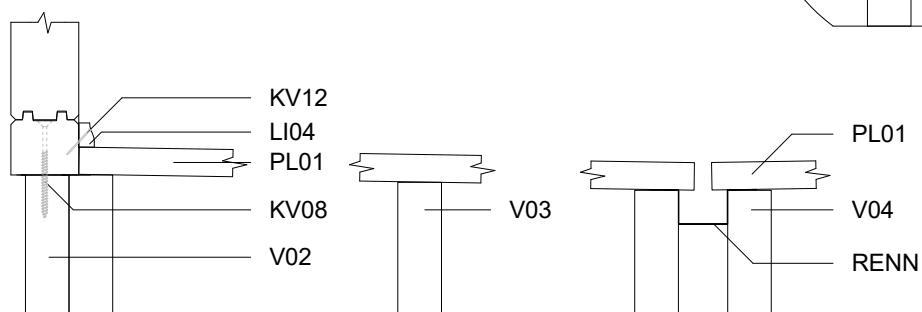

# Pihasauna Piha-Tuuri 7 - 70 mm / 234 x 344 cm - 2; A-A

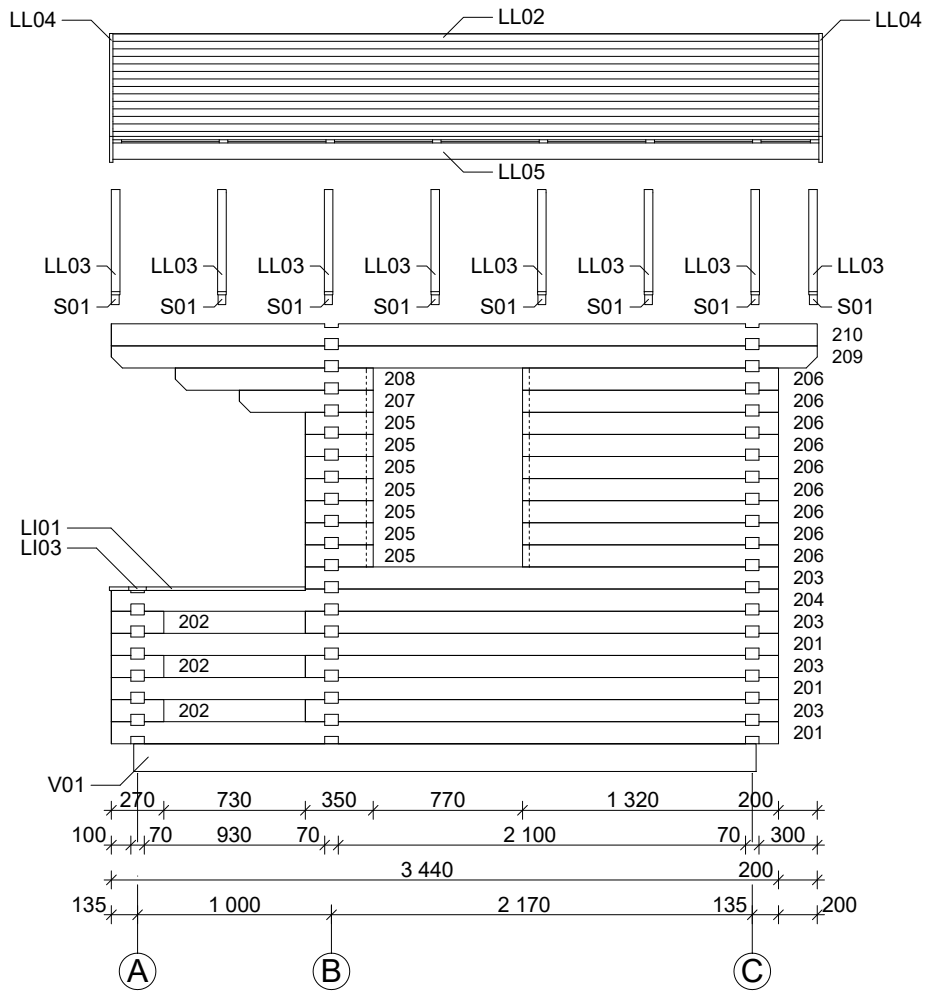



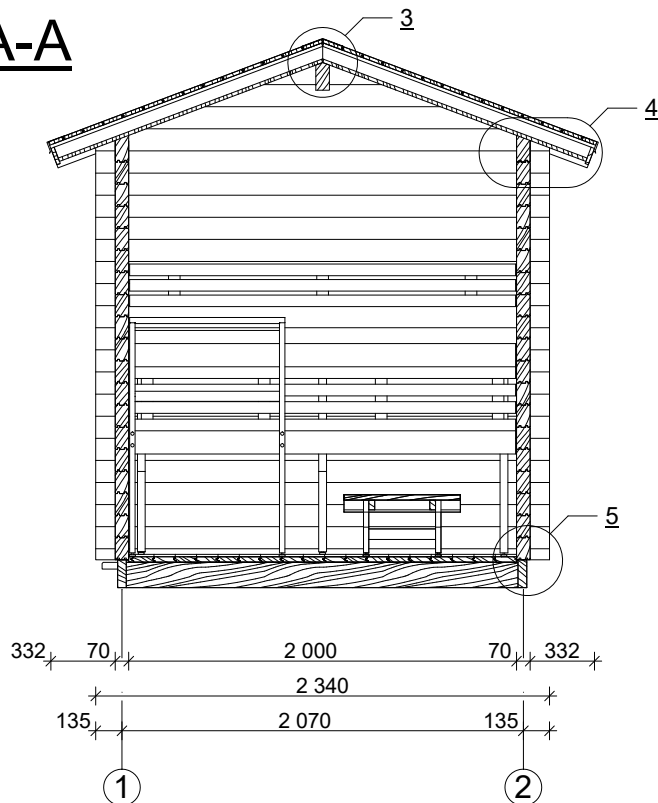









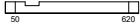
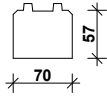

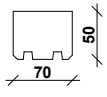

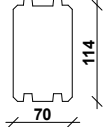

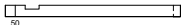
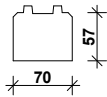
**A-A**

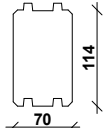









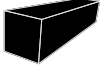

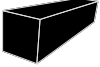

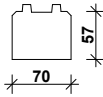

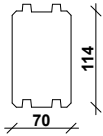



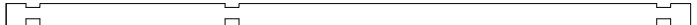
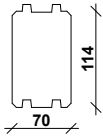



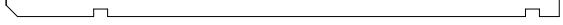



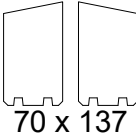





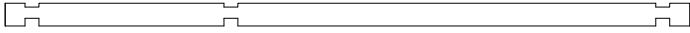
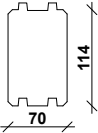

# Pihasauna Piha-Tuuri 7 - 70 mm / 234 x 344 cm - A; B

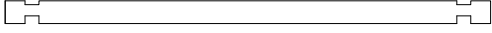
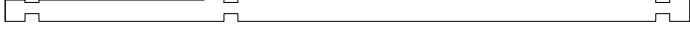
Nr.		 mm	 mm	 x
<b>A01</b>			670	2
<b>A02</b>			670	2
<b>A03</b>			670	8
<b>A04</b>			270	4
<b>A05</b>			150	4
<b>B01</b>			880	1
<b>B02</b>			610	1
<b>B03</b>			880	17
<b>B04</b>			610	17
<b>B05</b>			2340	1
<b>B06</b>			2340	1
<b>B07</b>			1821	1
<b>B08</b>		1214	1	
<b>B09</b>		607	1	



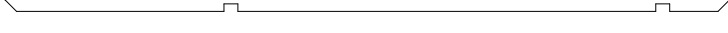

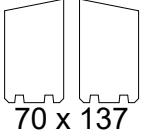

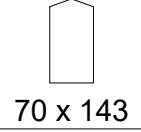







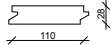
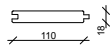

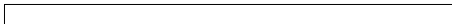
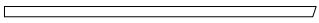
# Pihasauna Piha-Tuuri 7 - 70 mm / 234 x 344 cm - C; 1

Nr.		 mm	 mm	 x
<b>C01</b>			2340	1
<b>C02</b>			2340	18
<b>C03</b>			2340	1
<b>C04</b>			1821	1
<b>C05</b>			1214	1
<b>C06</b>			607	1
<b>101</b>			3440	3
<b>102</b>			270	3
<b>103</b>			2440	11
<b>104</b>			3440	1
<b>105</b>			2780	1
<b>106</b>			3110	1
<b>107</b>			3640	1
<b>108</b>				3640

## Pihasauna Piha-Tuuri 7 - 70 mm / 234 x 344 cm - 2

Nr.		 mm	 mm	 x
201			3440	3
202			270	3
203			2440	4
204			3440	1
205			350	7
206			1320	9
207			690	1
208			1020	1
209			3640	1
210			3640	1
LT			3640	1

## Piha-Tuuri 7 / 234 x 344 cm - 70 mm - Specification / Teilleiste

Nr.		 mm	 mm	 x
<b>V01</b>	Foundation beams / Fundamenthölzer	45 x 145	3210	2
<b>V02</b>			2020	8
<b>V03</b>			2020	2
<b>V04</b>			2020	2
<b>TL01</b>	Terrace board / Terrassendielen		930	10
<b>TL02</b>			1000	10
<b>PL01</b>	Floor boards / Fußbodenbretter		1040	38+1
<b>LL01</b>	Ceiling boards / Deckenbretter		1450	68
<b>LL02</b>	Roof board / Dachbretter		3640	28+2
<b>LL03</b>	Trim / Leiste	18x44	1498	16
<b>LL04</b>	Fascia board / Giebelblende 	18x143	1513	4
<b>LL05</b>	Eave edging / Traufenbrett 	18x90	3640	2
<b>S01</b>	Rafter / Dachsparren 	40x60	1479	16
<b>LI01</b>	Handrail / Terrassenabschußbrett	18x90	1010	2
<b>LI02</b>			500	2
<b>LI03</b>			100	2
<b>LI04</b>	Baseboard / Fußleisten 		ca. 8,3 m	
<b>ISTE</b>	Bench / Bank 		930	2
<b>ALUS*</b>	Underlay / Unterlage 		ca. 11,4 m	
<b>PP01*</b>	Flashing 		2500	6
<b>PP02*</b>	Flashing 		1700	3
<b>KV01</b>	Threaded Rod	∅ 10	2200	4
<b>KV02</b>			780	4
<b>KV03</b>	Nut, washer / Mutter, Scheibe			12
<b>KV04</b>	T-nut			4
<b>KV05</b>	Screws / Schrauben 4,0 x 40			80
<b>KV06</b>	Screws / Schrauben 4,0 x 50			800
<b>KV07</b>	Screws / Schrauben 5,0 x 70			100
<b>KV08</b>	Screws / Schrauben 5,0 x 100			60
<b>KV09</b>	Screws / Schrauben 5,0 x 120			130
<b>KV10</b>	Screws / Schrauben 6,0 x 140			30
<b>KV11</b>	Roof screw / Dachschraube			50
<b>KV12</b>	Nails / Nägel 1,4 x 35			50
<b>LK</b>	Hit block / Schlaghölzer	70x114		
<b>VR01</b>	Ventilation grate ∅100 mm 			1
<b>VR02</b>	Disc valve ∅100 mm 			1
<b>RENN</b>	Gutter / Rinne 		2195	1
<b>LAVA</b>	Sauna set 		1990	1



# Sauna set

A-A

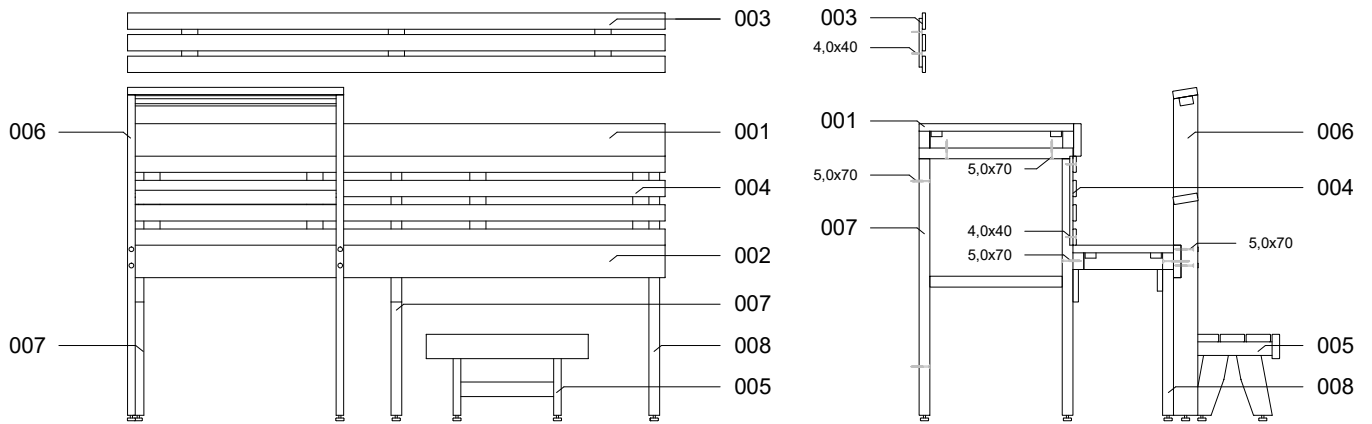



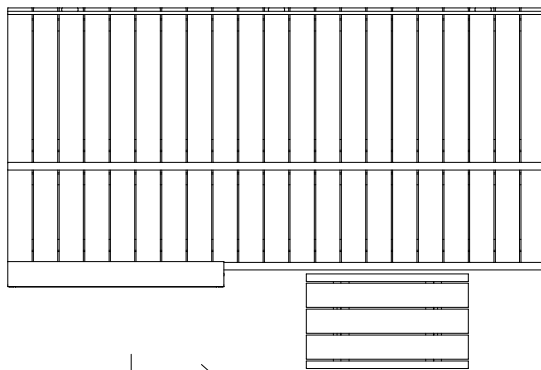

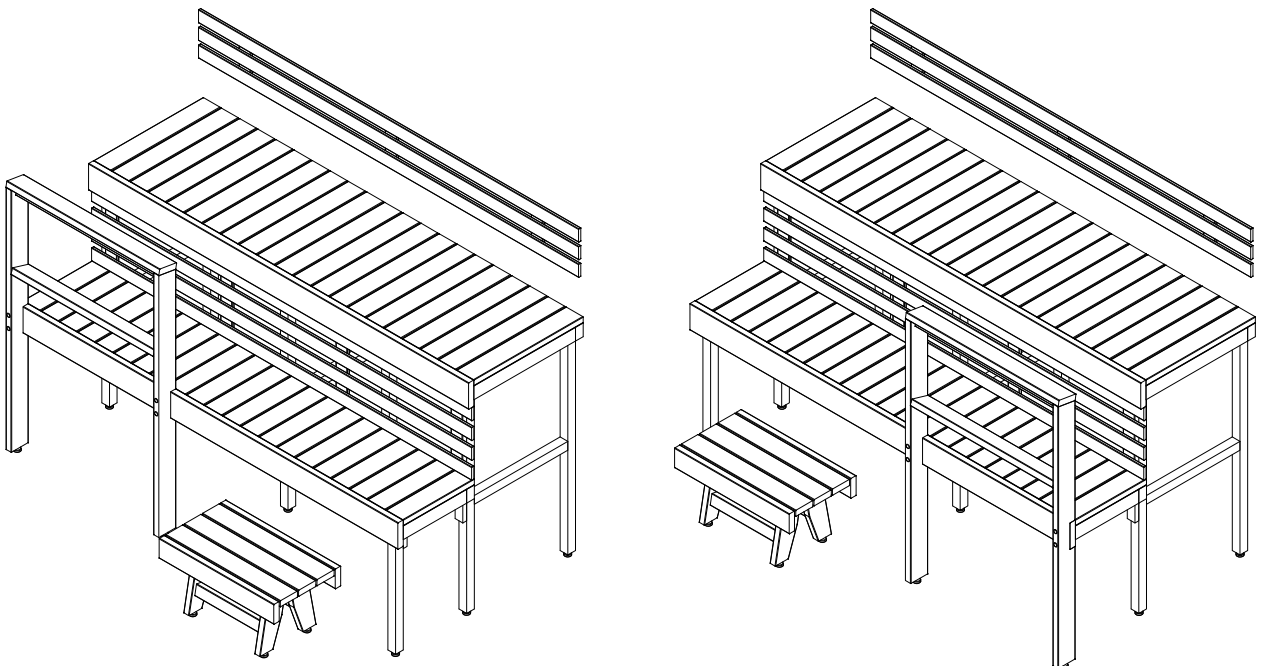

**A** →

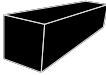
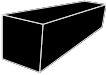

**A** →

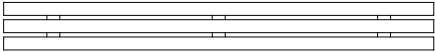
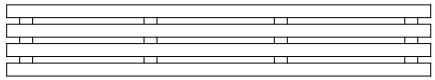

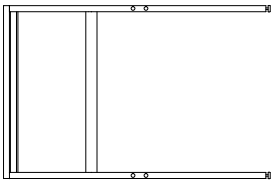
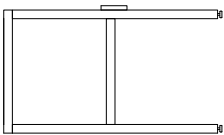
# Sauna set Specification / Teileliste

Nr.		 x
001		1
002		1
003		1
004		1
005		1
006		1
007		3
008		1