

# Techn. Daten: Leon A

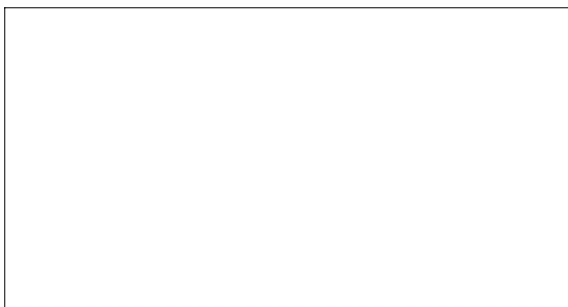

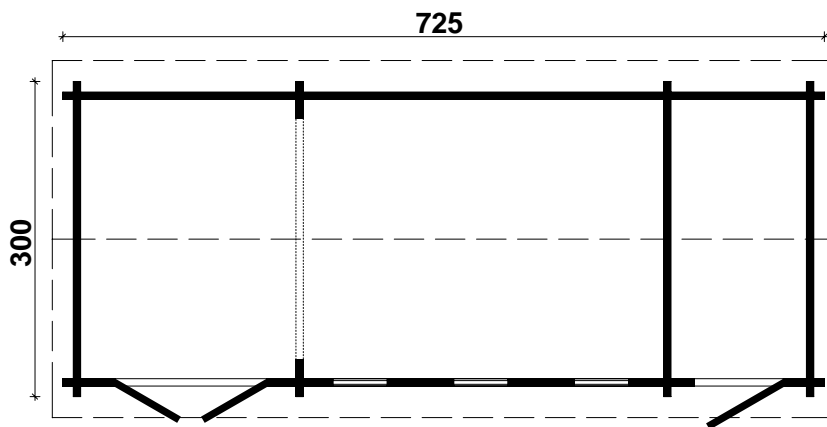







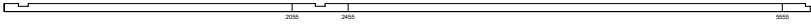





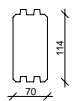

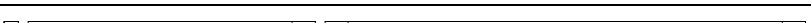
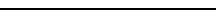





Bohlenaußenmaß (B x T): 300 x 725 cm

Wandaußenmaß: 280 x 705 cm - Bohlenstärke: 70 mm

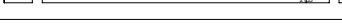
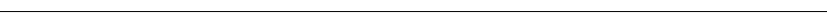

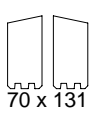

Achtung : Alle angegebenen Maße sind ca. - Maße !

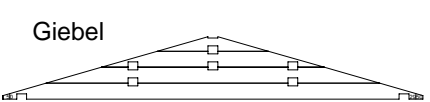
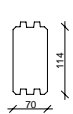
# Teilleiste Leon A 70 mm / 300 x 725 cm

Nr.	Beschreibung	Profil mm	Länge mm	Stück
001	Fundamenthölzer		2770	3
002			5535	6
003			1275	6
004			470	2
005			5755	1
006			1495	1
007			500	1
008			4070	1
009		390	1	
010			3000	58
011			2255	9
012			4995	9
013			5755	8
014			1495	8
015			350	34
016			500	17
017			390	17
018			630	17
019			620	17
020			630	34
021			550	2
022			5855	5
023			1595	5
024		--	--	
025		--	--	
026		5055	1	
027		2395+14	1	
028			5855	1
029			1595	1
030			5055	4(2+2)
031			2395+14	4(2+2)
032			--	--
033			--	--
034	Giebel 		3000	4
035	Doppeltür ca. 1425 x 1955mm - 70 mm ISO			1
036	Einzeltür ca. 840 x 1955 mm - 70 mm ISO			1
037	Einzelfenster ca. 515 x 1890mm - 70 mm ISO			3

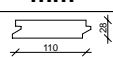
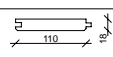
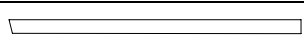
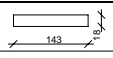
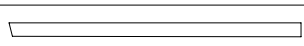
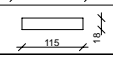
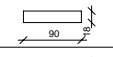
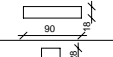
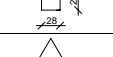
# Teileliste Leon A 70 mm / 300 x 725 cm

Nr.	Beschreibung	Profil mm	Länge mm	Stück
038	Fußbodenbretter		2657	63+1
039	Dachpappe		--	--
040	Dachbretter		1770	136+2
041	Giebelblende 		1810	4
042	Giebelblende 		1810	4
043	Giebelabschlussbrett		1810	4
044	Traufenbrett		3725	4
045	Traufenleiste		3725	4
046	Raute			2
047	Dübel			60
048	Gewindestangen	∅ 10	2250	8
049	Mutter, Scheibe			16
050	Nägel 2,2 x 50 ; 2,5 x 70			1 Beutel
051	Dachpappnägel 3,0 x 15			--
052	Schrauben 4,0 x 40; 5,0 x 100			1 Beutel
053	Fußleisten		ca. 25,0 m	
054	Schlaghölzer		300-400	

# Leon A 70 mm / 300 x 725 cm

## Fundamentplan

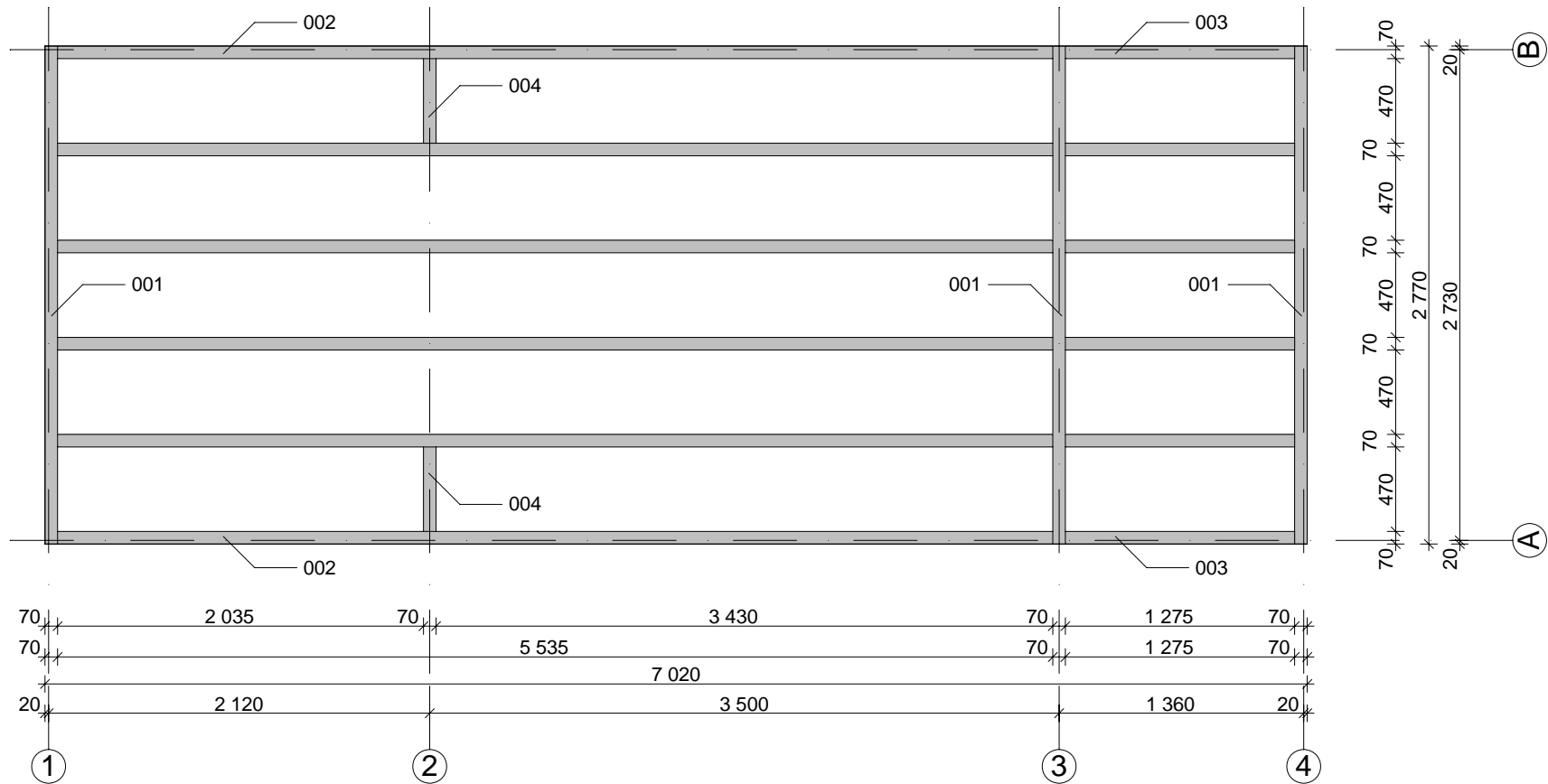

# Leon A 70 mm / 300 x 725 cm

## Wandplan

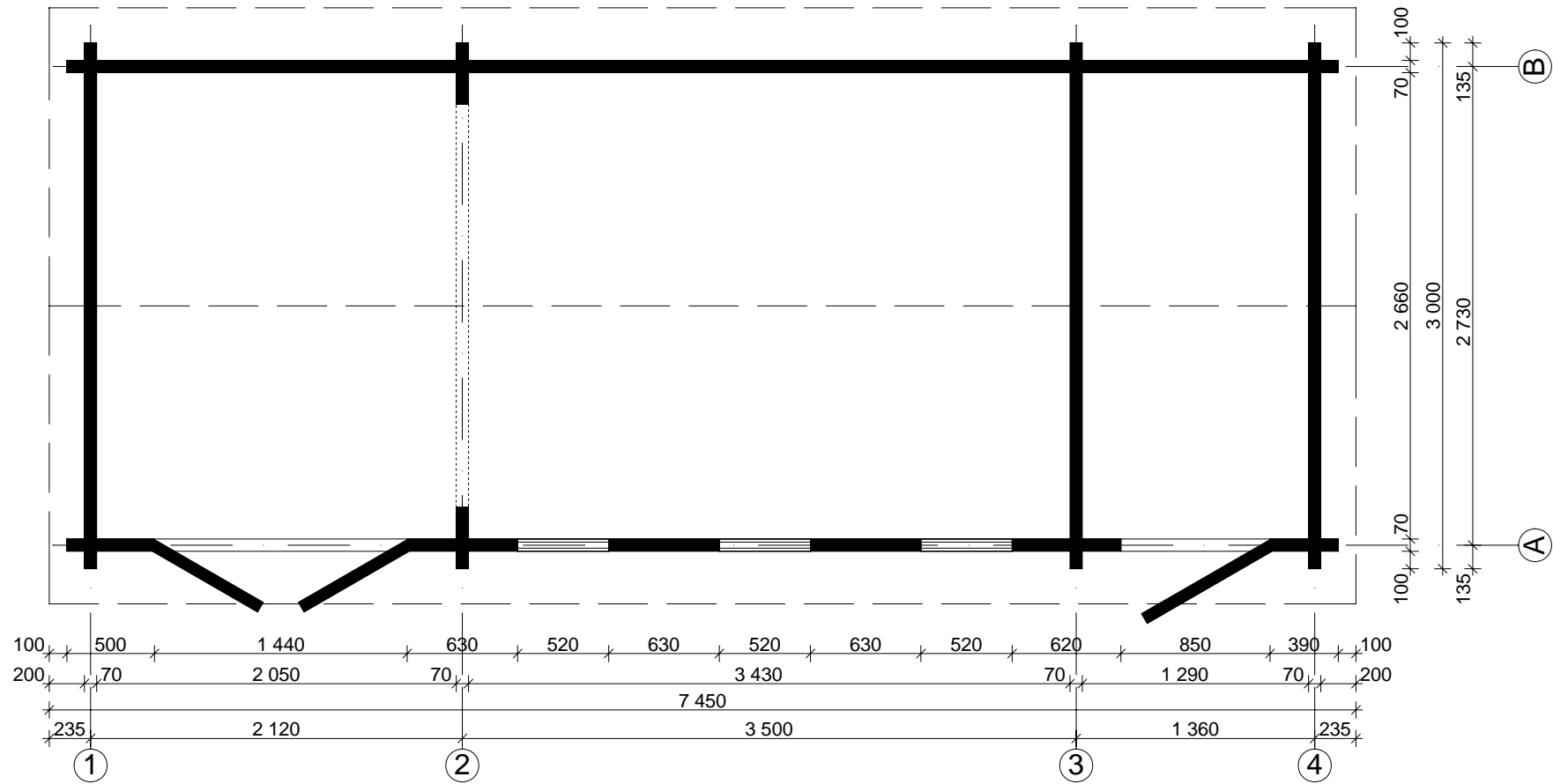

# Leon A 70 mm / 300 x 725 cm

**1, 3, 4**

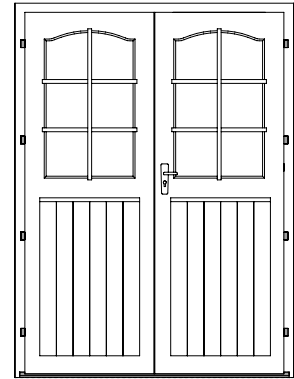
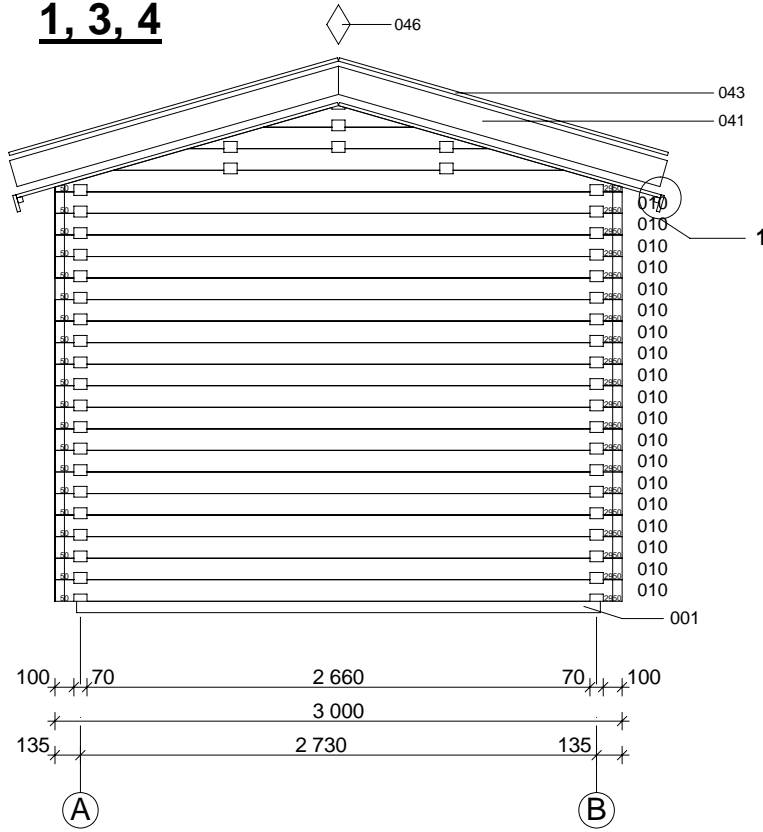

**Doppeltür**  
70 mm ISO  
1425 x 1955 mm  
1 st.

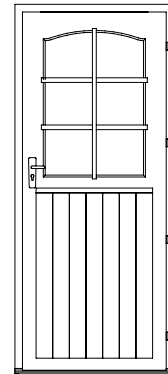

**Einzeltür**  
70 mm ISO  
840 x 1955 mm  
1 st.

**2**

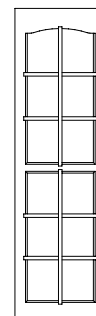
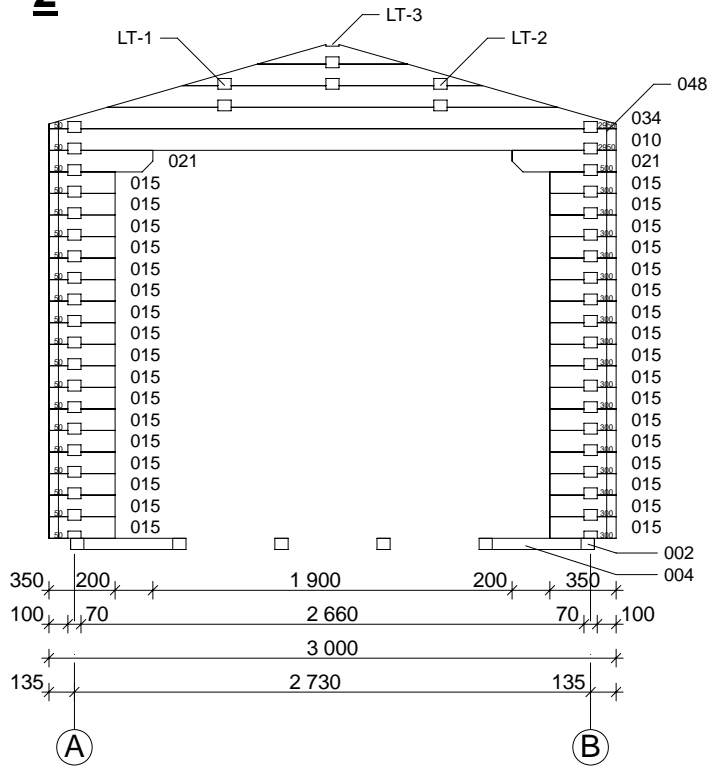

**Einzelfenster**  
70 mm ISO  
515 x 1890 mm  
3 st.

# Leon A 70 mm / 300 x 725 cm

**A**

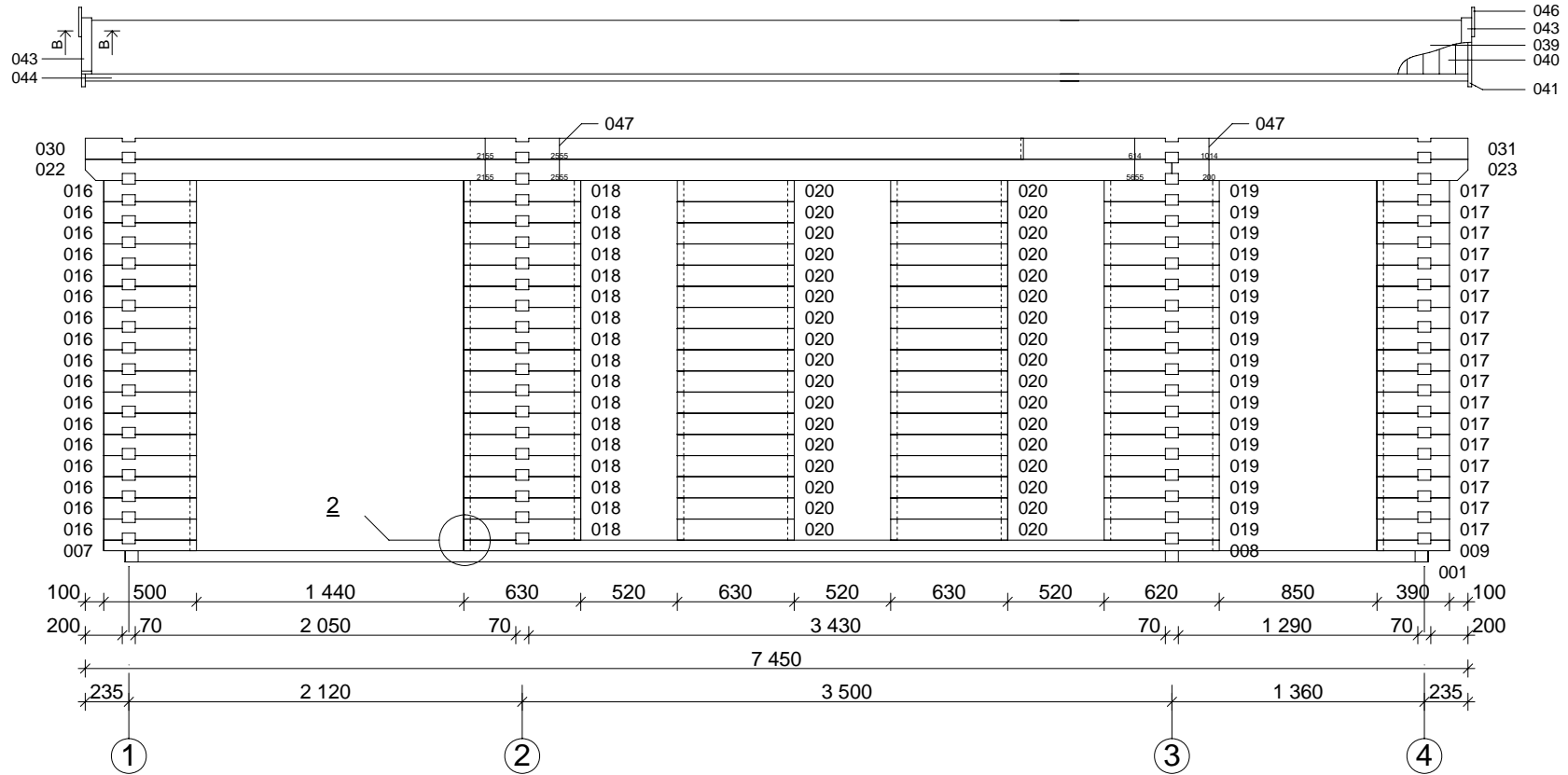

**A-A**

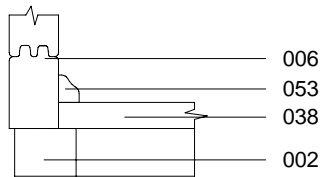

**B-B**

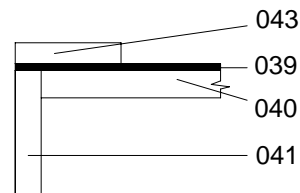

# Leon A 70 mm / 300 x 725 cm

**B**

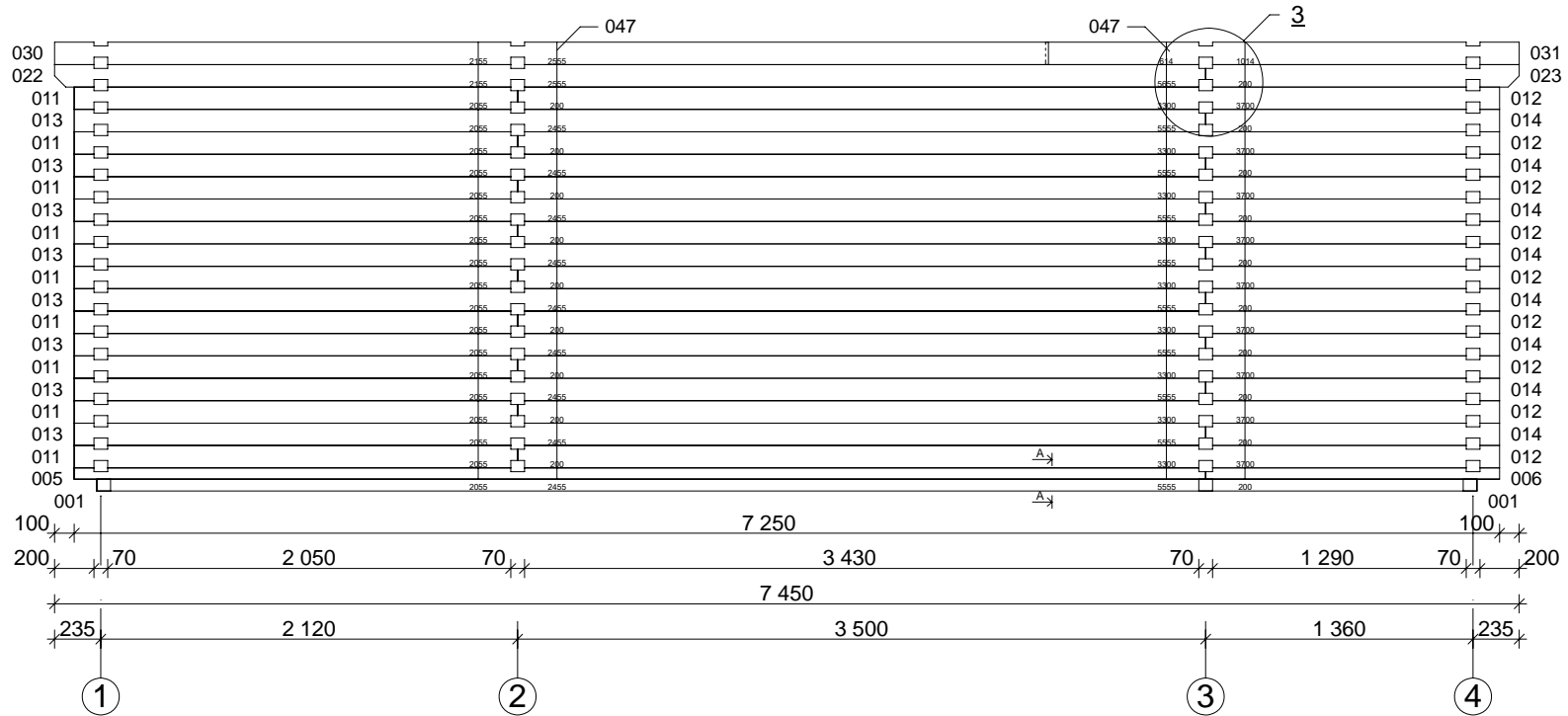



# Leon A 70 mm / 300 x 725 cm

## LT-1

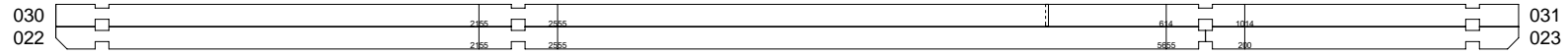

## LT-2

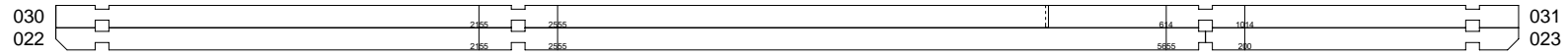

## LT-3

