

# Techn. Data / Daten: Kotka

Log length (W x D) / Bohlenaußenmaß (B x T): 595 x 595 cm

Wall size(outside) / Wandaußenmaß: 575 x 575 cm

Log thickness / Bohlenstärke: 40 mm

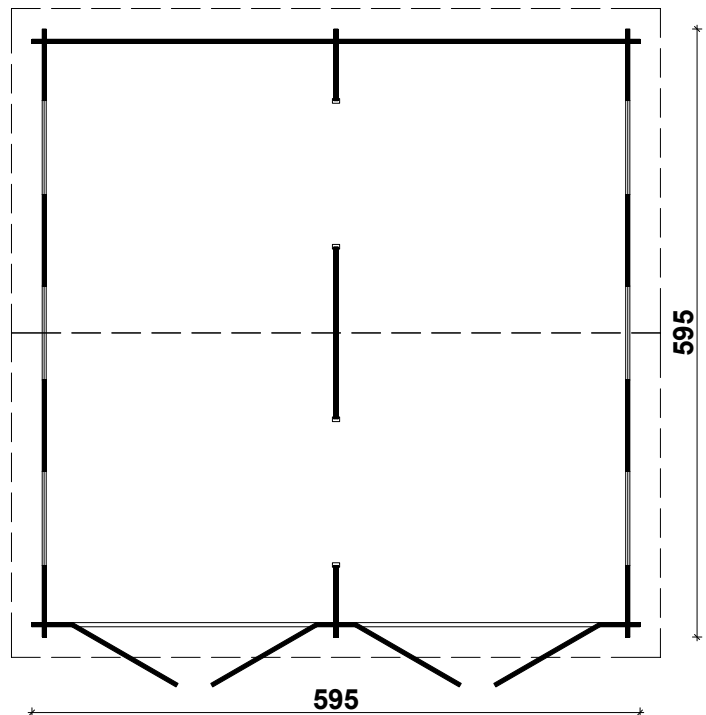
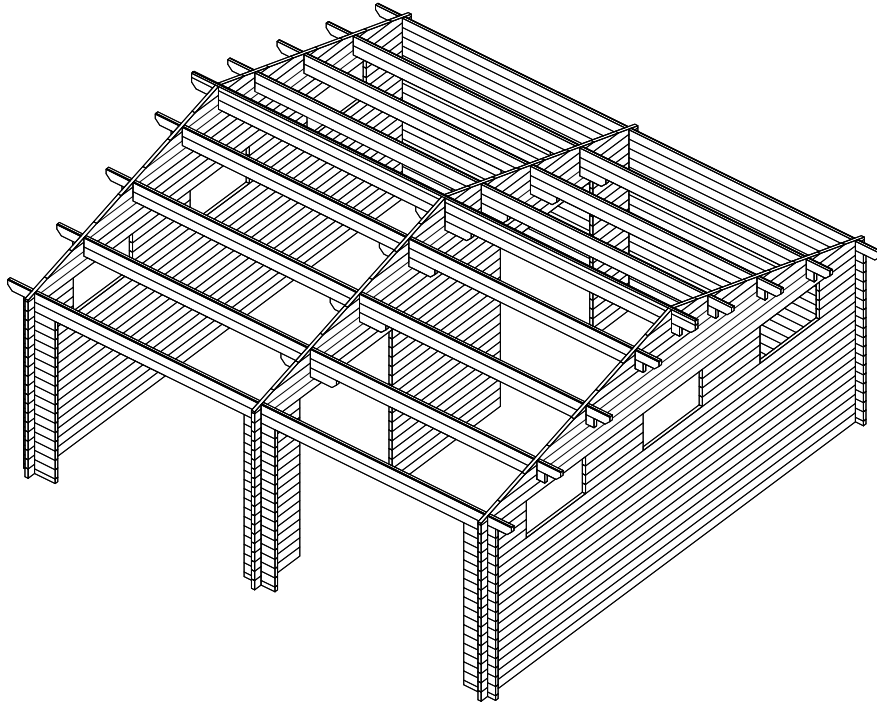

Note: All dimensions are approximate ! / Achtung : Alle angegebenen Maße sind ca. - Maße !

# Kotka 40 mm / 595 x 595 cm - Fundamentplan

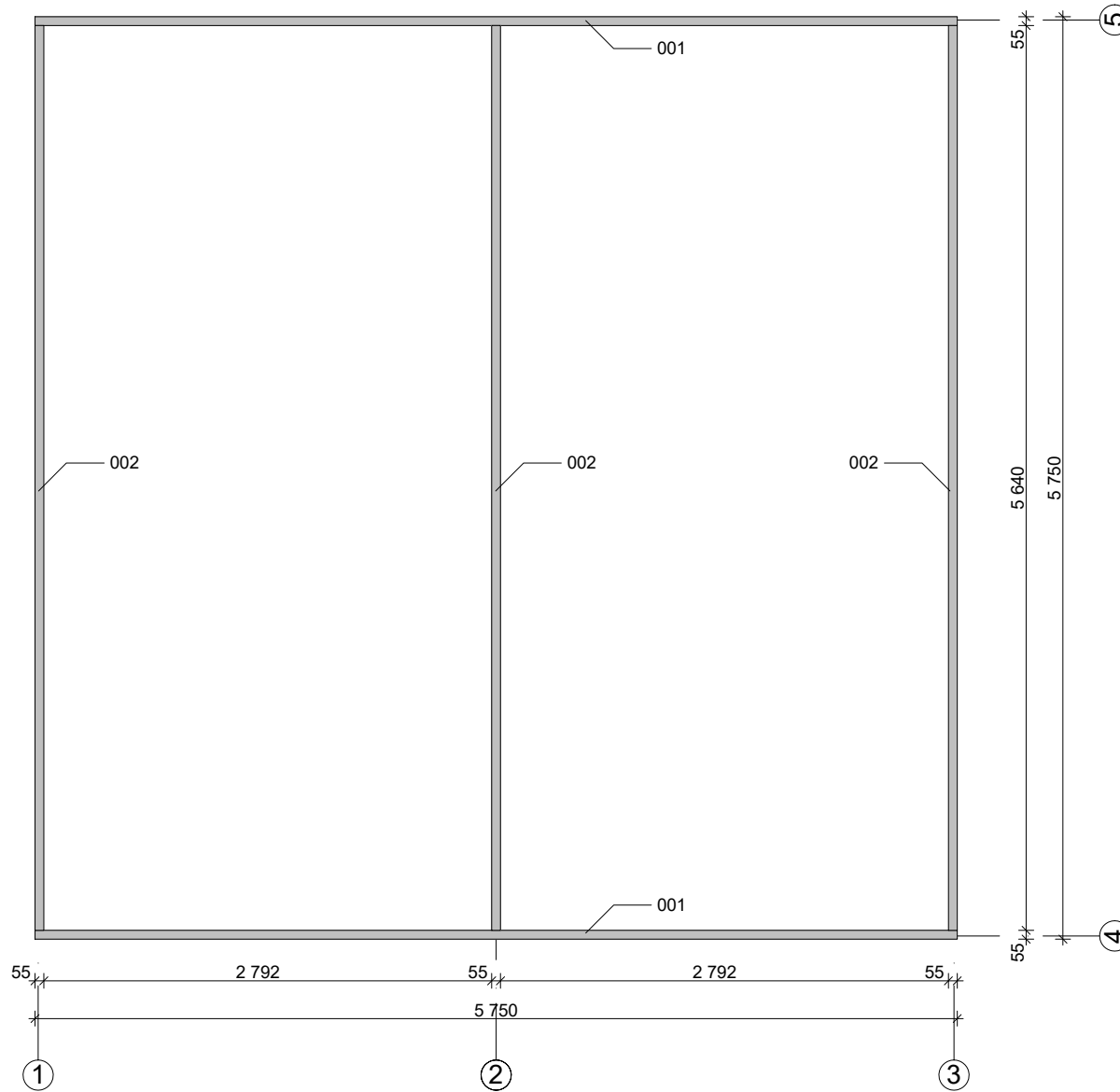

# Kotka 40 mm / 595 x 595 cm - Wandplan

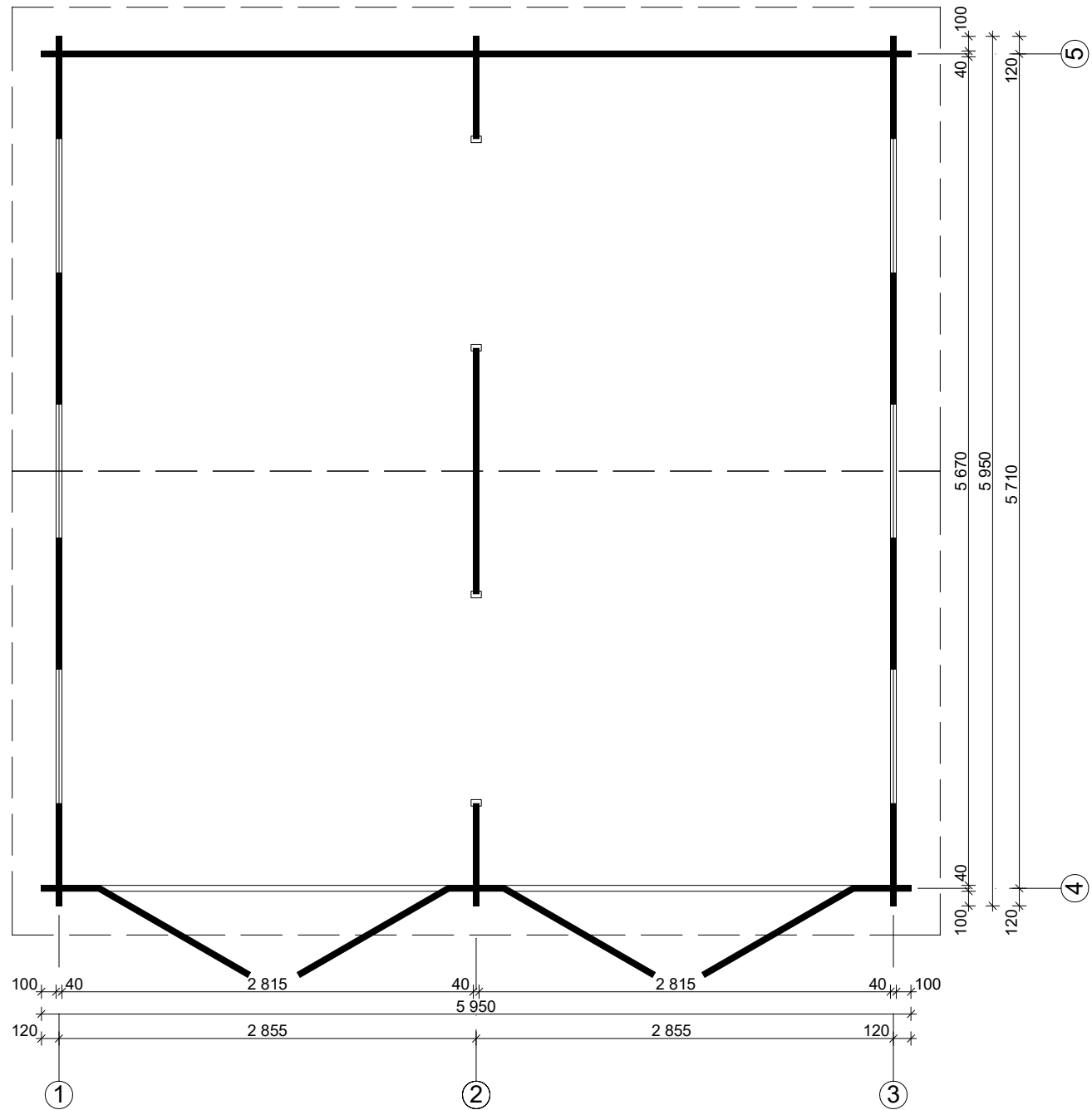



# Kotka 40 mm / 595 x 595 cm - 2

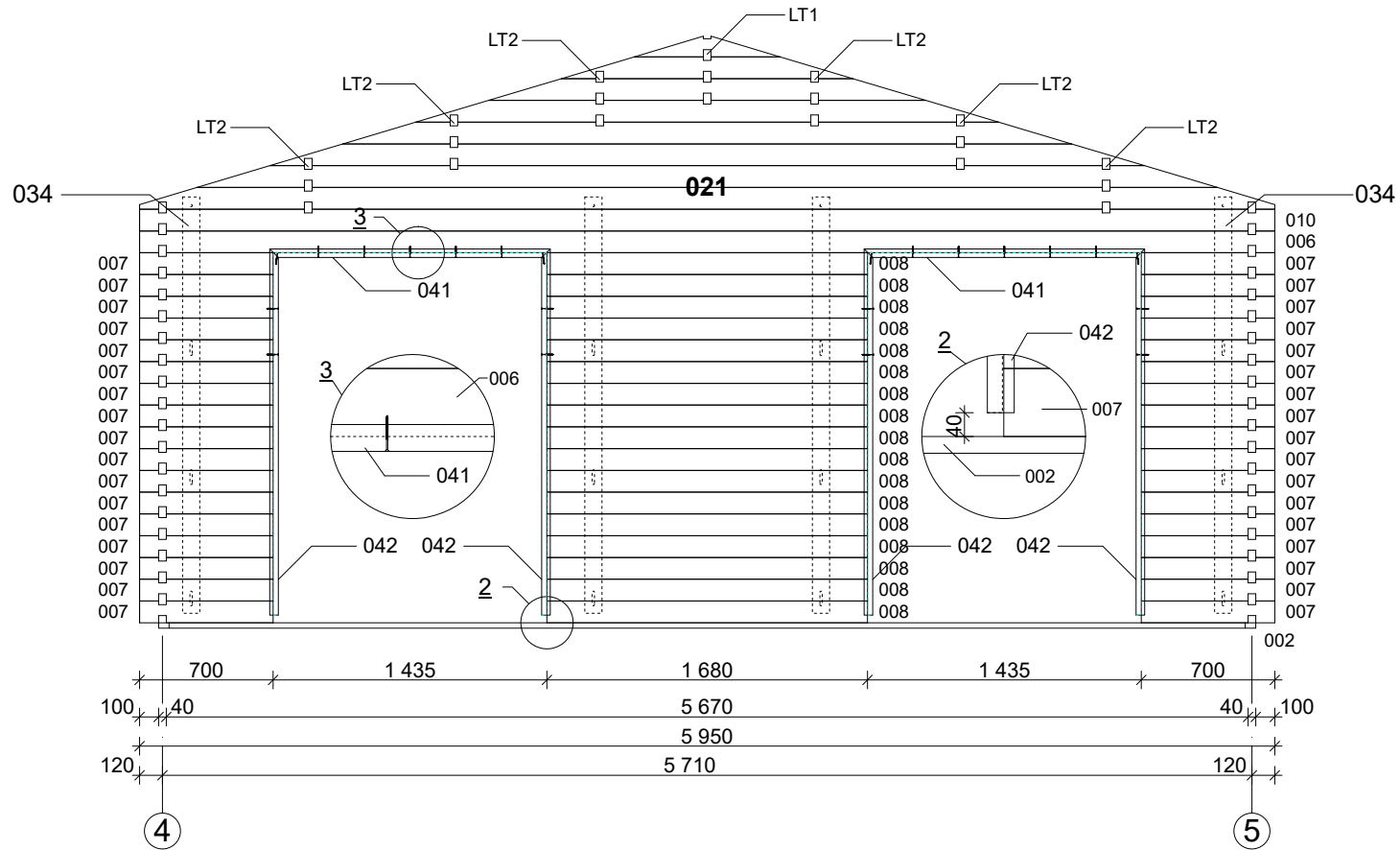

# Kotka 40 mm / 595 x 595 cm - 4

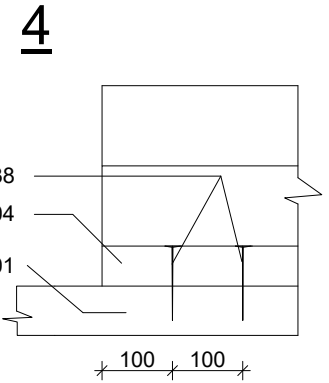
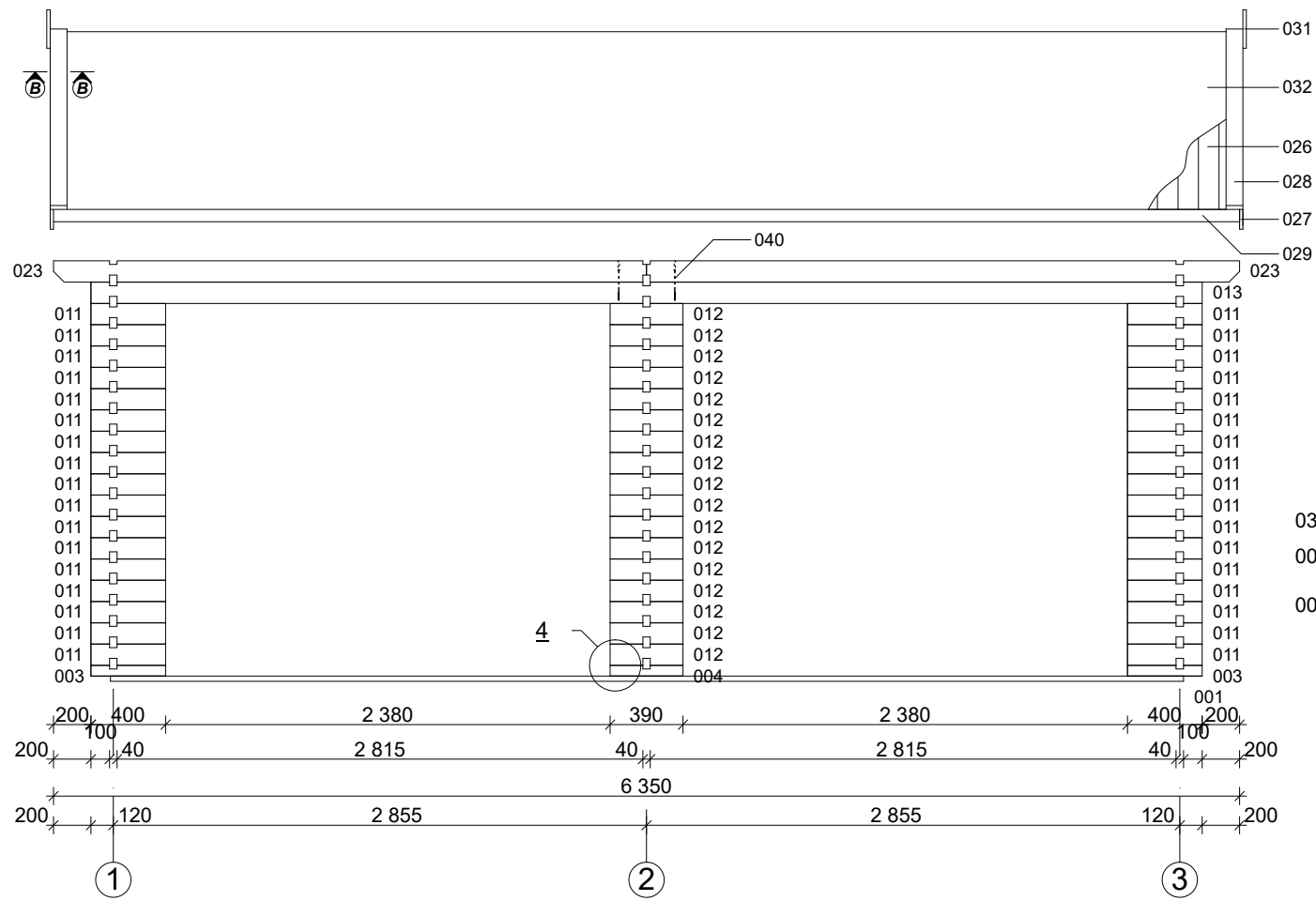

## A-A

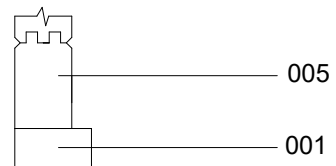



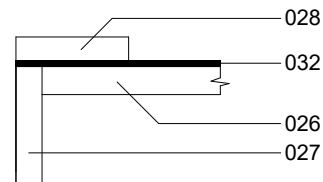

















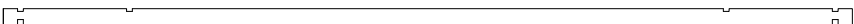

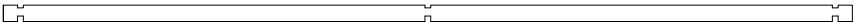

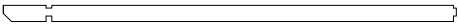
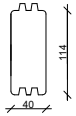
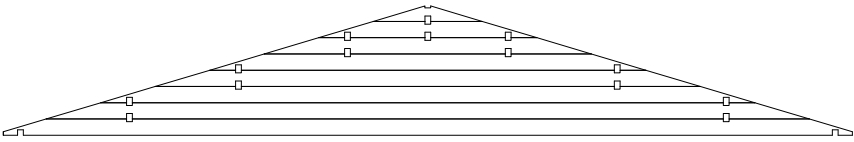
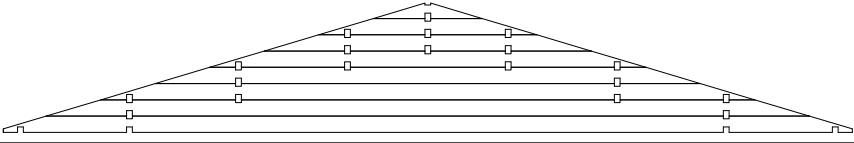

## B-B

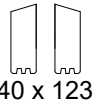

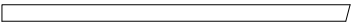

# Kotka 40 mm / 595 x 595 cm - Specification / Teileliste

Nr.		 mm	 mm	 x
001	Foundation beams / Fundamenthölzer	28 x 55	5750	2
002			5640	3
003			400	2
004			390	1
005			5950	1
006			5950	31
007			700	50
008			1680	17
009			895	16
010			5950	1
011			400	34
012			390	17
013			5950	26
014			700	7
015			3175	2
016			--	--
017			--	--
018			--	--
019			--	--
020			5950	2
021			5950	1
022			3175	2
023			3175	16(8+8)
024			--	--
025			--	--
026	Roof boards / Dachbretter		3310	116+2
027	Fascia board / Giebelblende 		3350	4
028	Gable edge board / Giebelabschlussbrett		3350	4
029	Eave edging / Traufenbrett		3175	4
030	Eave edging slat / Traufenleiste		3175	4
031	Diamond / Raute			2



