

Techn. Data / Daten: Garage D

Log length (W x D): 595 x 530 cm

Bohlenaußenmaß (B x T): 595 x 530 cm





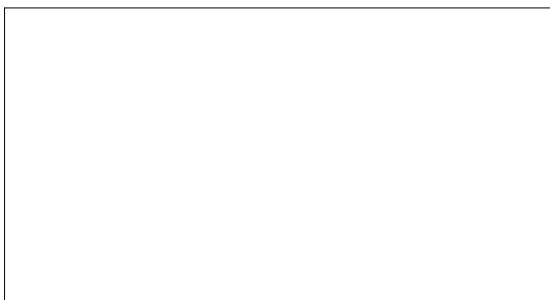
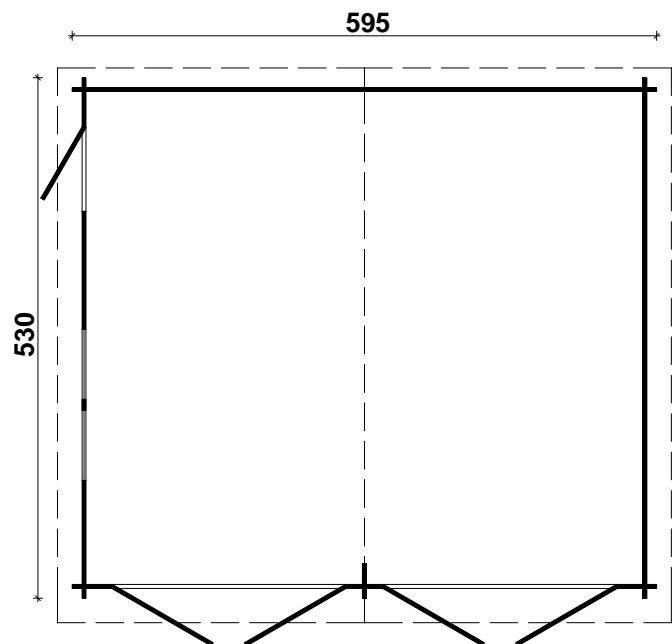









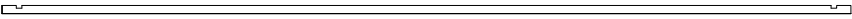





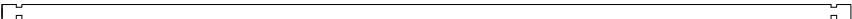











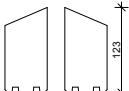

Wall size(outside): 575 x 510 cm-Log thickness: 40 mm

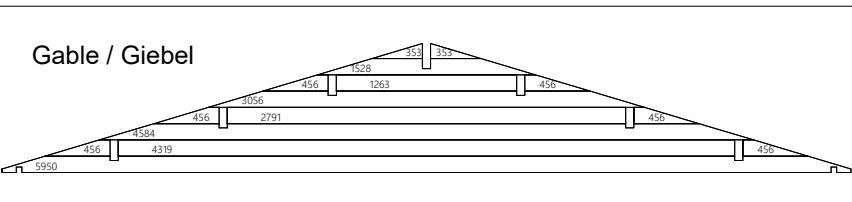
Wandaußenmaß: 575 x 510 cm · Bohlenstärke: 40 mm

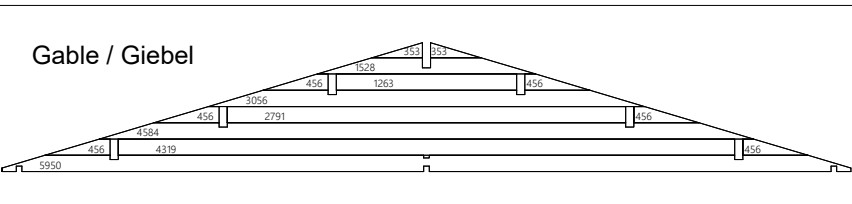

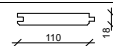

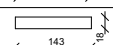

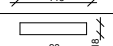

Note: All dimensions are approximate !
Achtung : Alle angegebenen Maße sind ca. - Maße !

Garage D 40 mm / 595 x 530 cm - Specification / Teileliste

Nr.		 mm	 mm	 x	
001	Foundation beams / Fundamenthölzer	28 x 55	5740	2	
002			4980	2	
003			130	1	
004			5950	1	
005			400	2	
006			390	1	
007			350	1	
008			5950	18	
009			5950	1	
010			5300	17	
011			3940	8	
012			1200	9	
013			510	17	
014			400	34	
015			350	19	
016			1200	9	
017			390	17	
018			5650	2	
019				5650	2(1+1)
020	Purlin / Dachbalken 			5650	6(3+3)
021	Purlin / Dachbalken 			5650	1
022	Gable / Giebel 			5950	1
023	Gable / Giebel 	5950		1	
024	Roof board / Dachbretter 		3260	104+2	
025	Fascia board / Giebelblende 		3300	4	
026	Gable edge board / Giebelabschlussbrett 		3300	4	

Garage D 40 mm / 595 x 530 cm - Specification / Teileliste

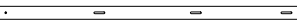
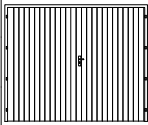
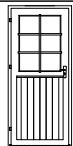
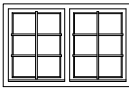
Nr.		 mm	 mm	 x
027	Eave edging / Traufenbrett		5650	2
028	Eave edging slat / Traufenleiste		2825	4
029	Diamond / Raute			2
030	Roofing felt / Dachpappe		--	--
031	Storm brace / Sturmleisten 	40 x 90	2090	5
032			--	--
033	Bolt M 8 x 90, nut, washer / Schloßschrauben M 8 x 90, Mutter, Scheibe			20
034	Screws / Schrauben 4,0 x 40; 5,0 x 70; 5,0 x 100			120 / 30 / 10
035	Screws / Schrauben 4,0 x 50			600
036	Nails / Nägel 3,0 x 15			--
037	Hitblock / Schlaghölzer	40 x 114	300-400	
038	Double door / Doppeltür 2370 x 1955 mm - 40 mm - R			2
039	Door / Einzeltür 840 x 1900 mm - 40 mm - L			1
040	Double window / Doppelfenster 1530 x 990 mm - 40 mm			1

Garage D 40 mm / 595 x 530 cm - Foundation joist / Fundamentplan

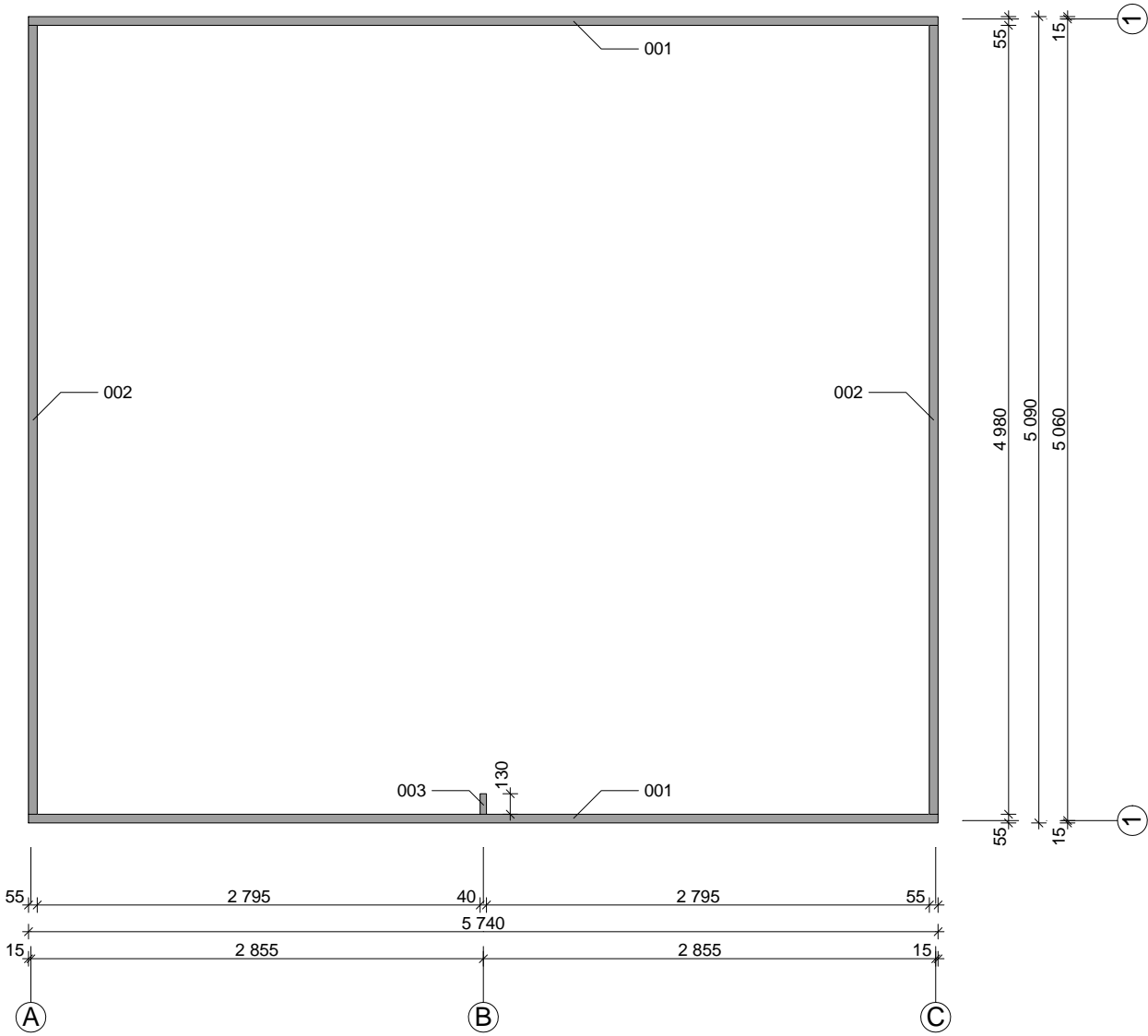

Garage D 40 mm / 595 x 530 cm - Ground plan / Wandplan

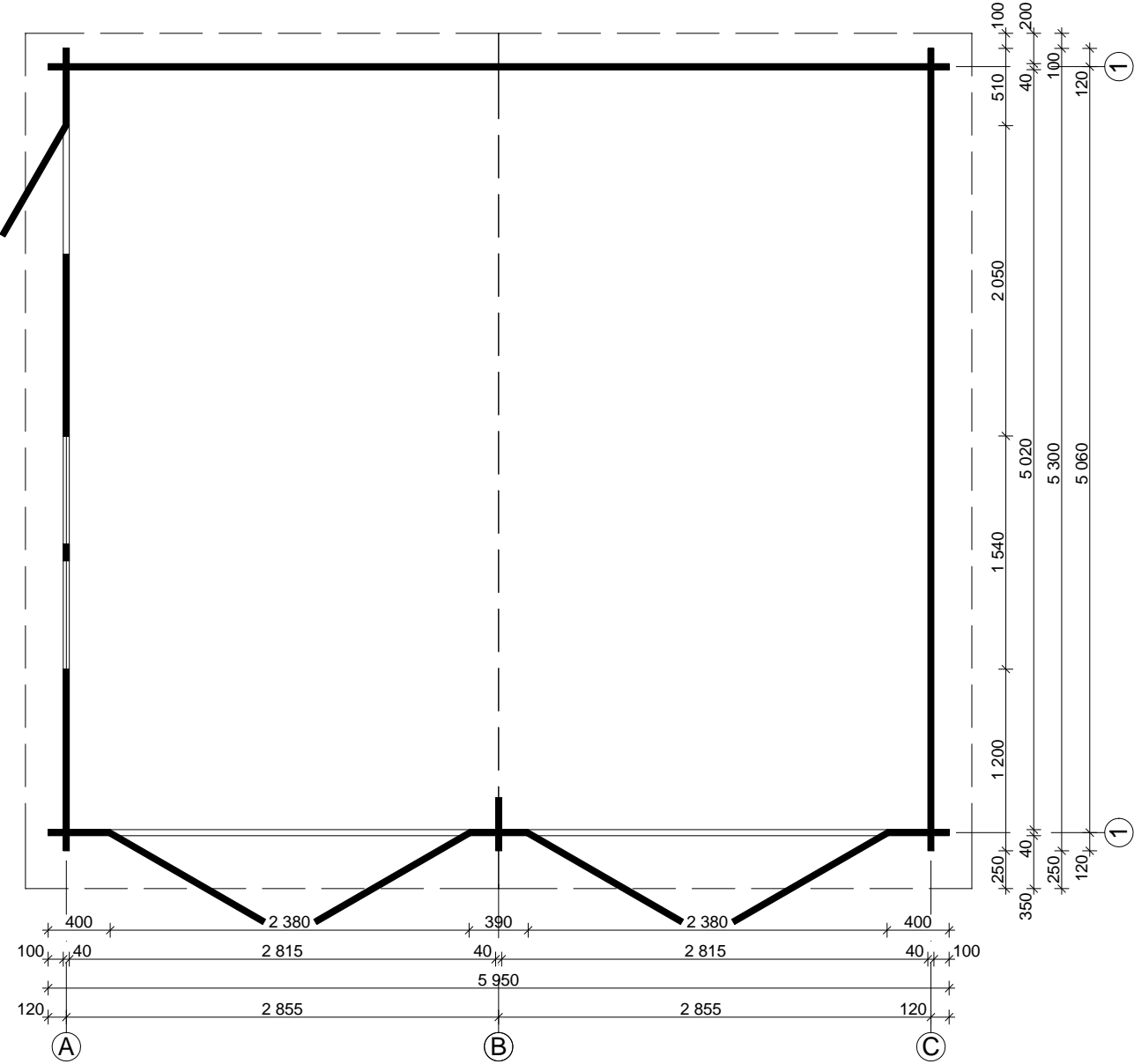

Garage D 40 mm / 595 x 530 cm - 1

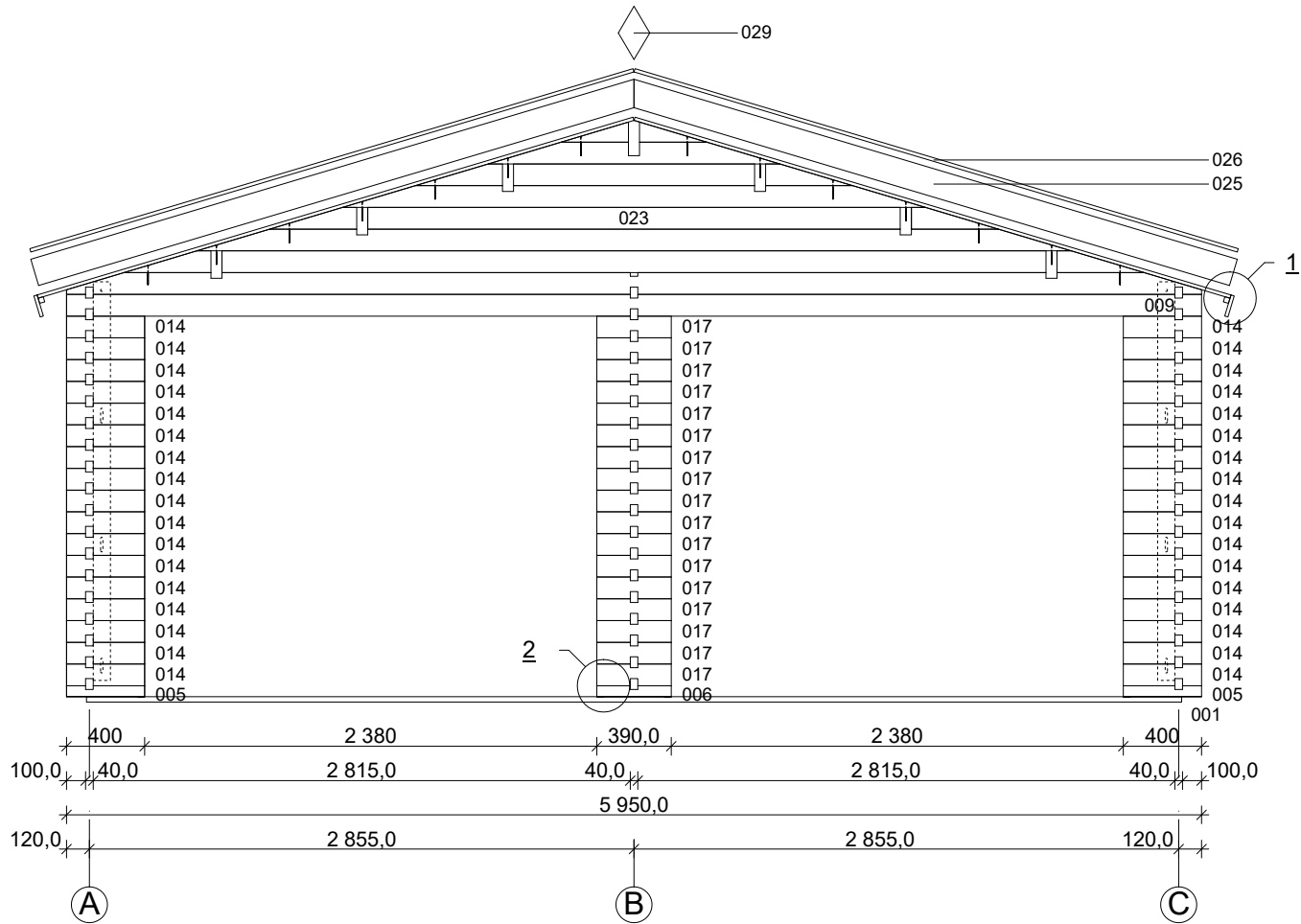

Garage D 40 mm / 595 x 530 cm - 2

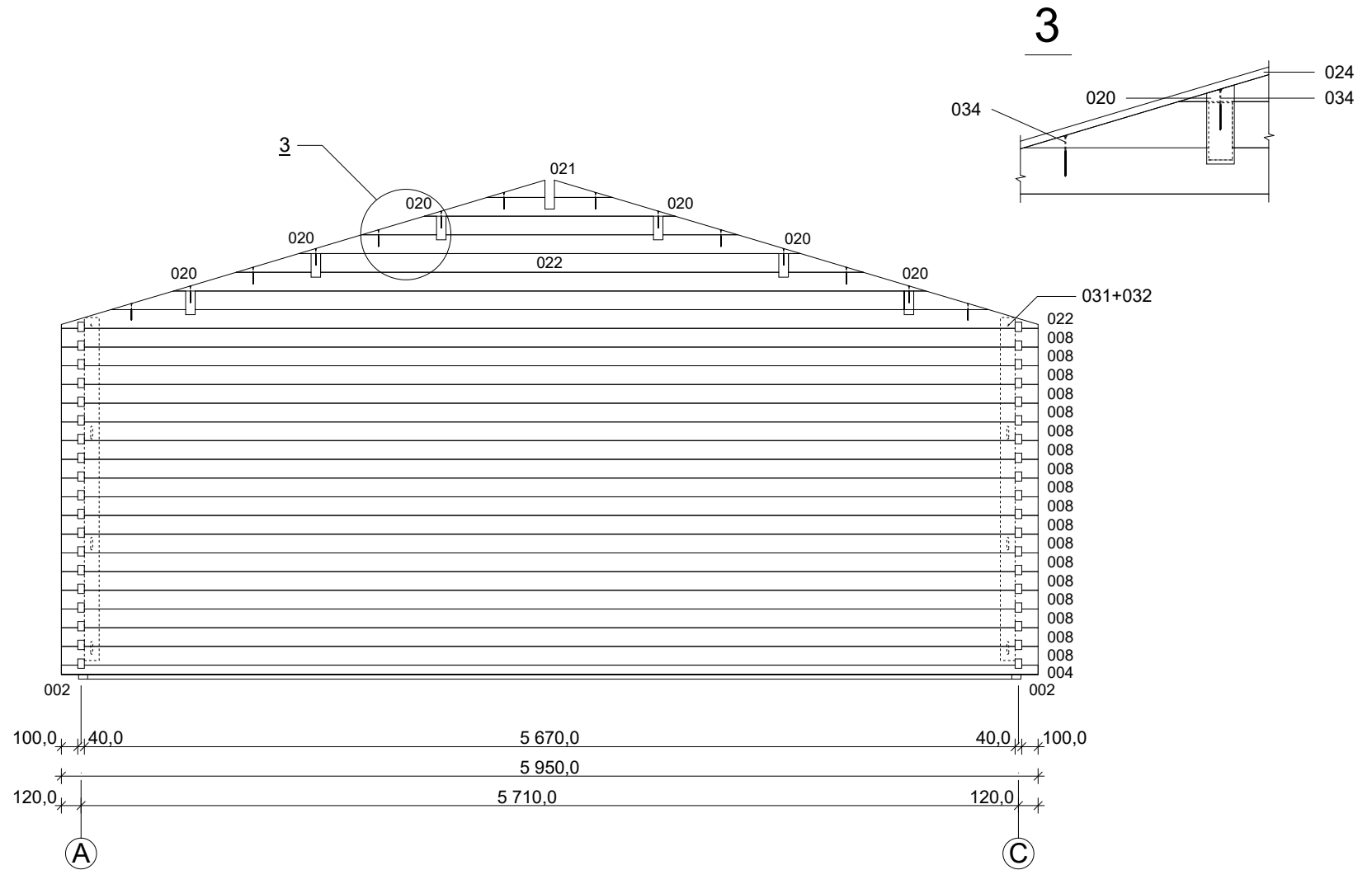

Garage D 40 mm / 595 x 530 cm - pos. 22 &23

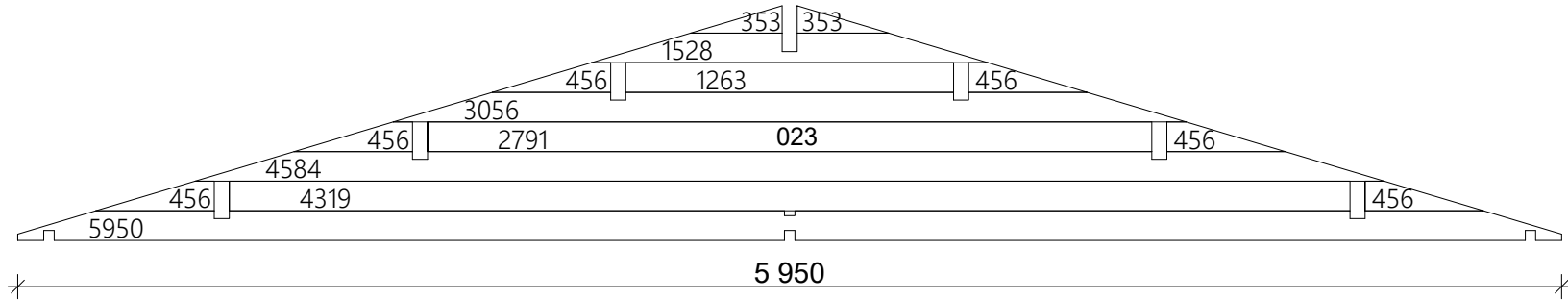
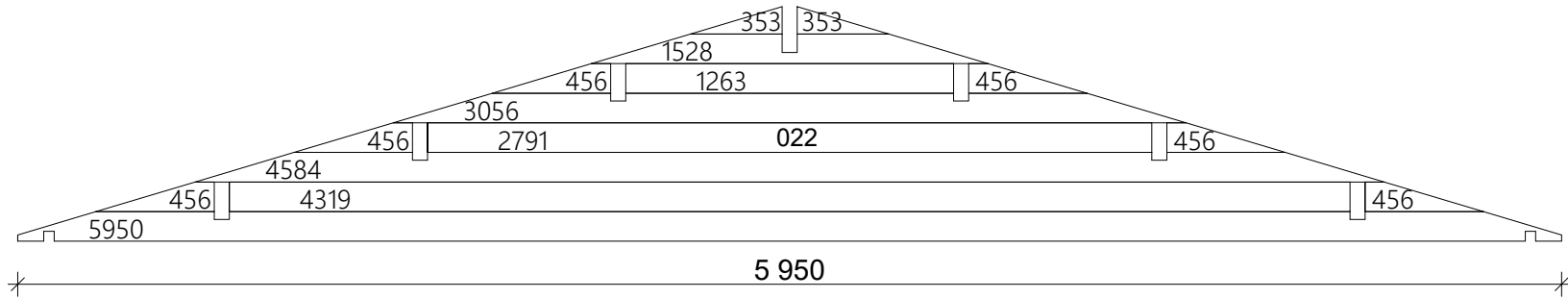

Garage D 40 mm / 595 x 530 cm - A, B

A

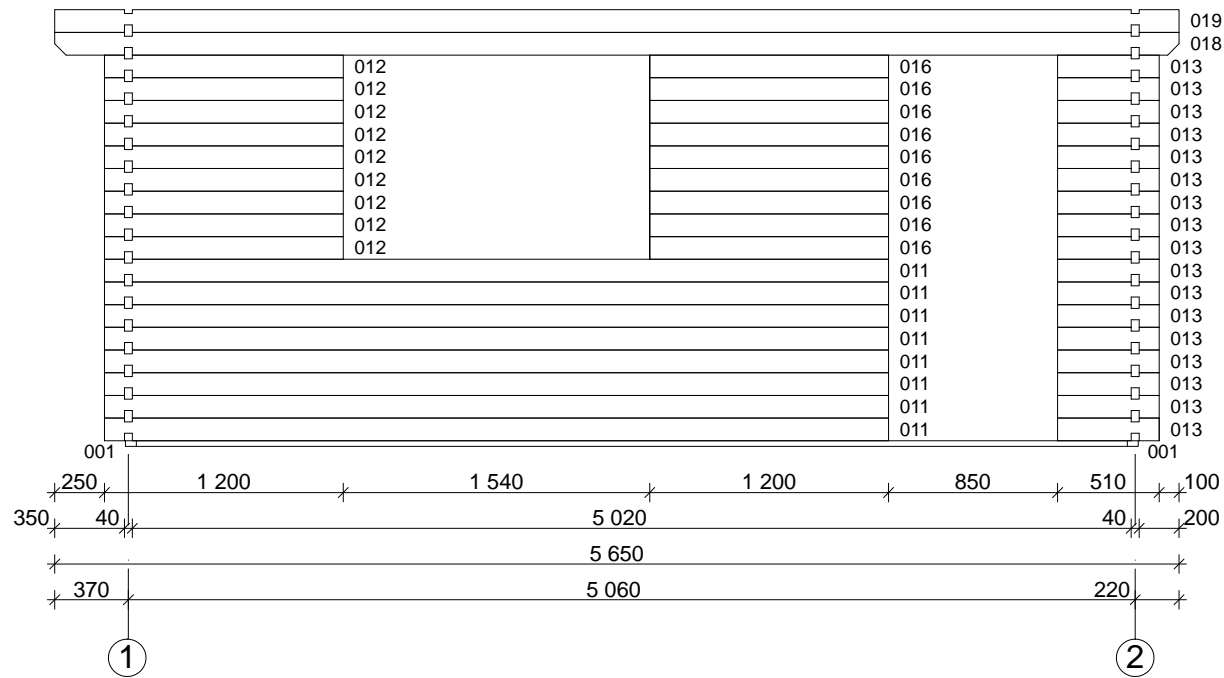

B

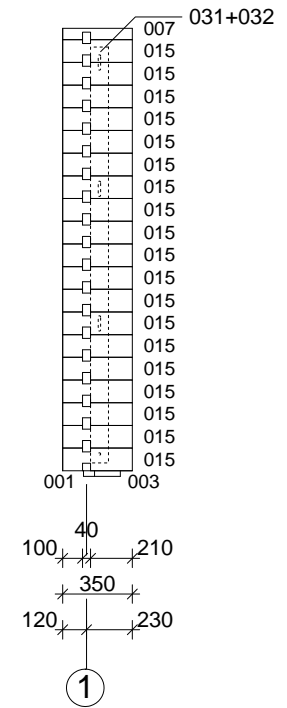

Garage D 40 mm / 595 x 530 cm - C

