

Installation manual

Montageanleitung • Notice de montage • Istruzioni per il montaggio • Manual de montaje • Monteringsanvisning • Installatiegids • Montážní návod • Asennusohje • Installationsmanual • Instrukcja instalacji • Paigaldusjuhend

Log cabin FR28-2632

Blockhaus • Maisonnette en poutres • Casa di travi • Casa de jardin • Anneks • Tuinhuis • Zahradní domek • Timmerstuga • Hirsimökki • Dom z bali • Freesprussmaja

Width 260 x Depth 320 cm











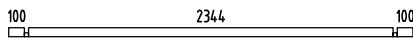
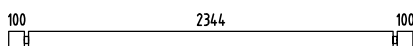
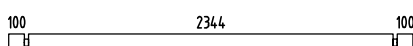

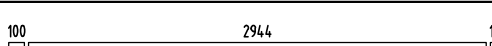
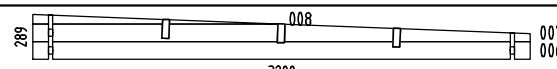
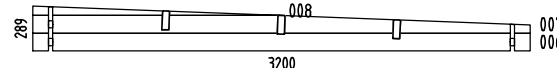
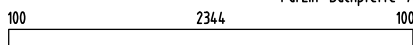

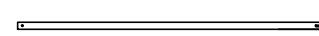
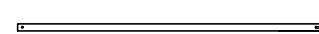

Breite/Tiefe • Largeur/Profondeur • Lunghezza/Profondità • Ancho/Profundidad • Bredde/Dybde • Breedte/Diepte • Šířka/Hloubka • Leveys/Pituus • Bredd/Längd • Szerokość/Głębokość • Laius/pikkus

Log thickness 28 mm

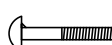
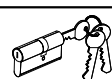
Bohlenstärke • Épaisseur des murs • Spessore delle pareti • Grosor de pared • Tykkelse • Wanddicke • Tloušťka stěny • Seinän paksuus • Väggtjocklek • Grubość ścian • Seinapaksus

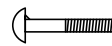

The producer shall have the right to make technical changes to the product • Technische Änderungen vorbehalten • Le producteur réserve le droit d'effectuer des modifications techniques au produit • Il produttore mantiene il diritto di apportare modifiche tecniche al prodotto • Reservado el derecho a modificaciones técnicas • Produsent forbeholder seg retten til å endre tekniske egenskaper ved produktet • Alle rechten en technische wijzigingen voorbehouden • Výrobce si vyhrazuje právo na technické změny výrobku • Valmistaja pidättää oikeuden tehdä tuotteeseen teknisiä muutoksia • Tillverkaren har rätt att utföra tekniska förändringar för produkten • Producent zastrzega sobie prawo do dokonywania zmian technicznych produktu • Tootja jätab endale õiguse muuta toote tehnilisi omadusi

Pos	SPECIFICATION-STÜCKLISTE-NOMENCLATURE-ELEMENTI-ESPECIFICACIÓN FR28-2632	Pcs	Profile (mm)	Length (mm)
001		1	28x57	2600
002		17	28x114	2600
003		2	28x114	2600
004		2	28x57	490
005		32	28x114	490
006		32	28x114	3200
WA-1		1		
WB-1		1		
PR1	 Purlin- Dachpfette- Arbalétrier- Arcareccio- Correa	3	44x140	2600
RB2-1	Roof board- Dachbrett- Madrier du toit- Tavola tetto- Tabla de tejado 	30	89x19	3360
EaE6-1	Eave edging- Dachrandbrett- Madrier en bordure du toit- Tavola bordo tetto- Tabla de valadizo 	2	19x120	2640
FaB7-1	Facia board- Giebelblende- Écran frontal- Schermo frontone- Tabla de facia 	2	19x120	3360
RE2-1	Roof edge reinforcement- Dachrandleiste- Baguette en bordure du toit- Rinforzo bordo tetto- Refuerzo borde tejado 	2	32x40	2600
SiS5-1	Side slat - Randleiste - Baguette en bordure - Llistello bordo 5 	2	28x45	1686
StB1-1	Storm brace- Sturmleiste- Protection contre le vent- Antivento- Protector contra tormentas 	2	25x45	1900
StB1-2	Storm brace- Sturmleiste- Protection contre le vent- Antivento- Protector contra tormentas 	2	25x45	2000
Fim	-Fixing kit- Befestigungsset- Moyens de fixation- Materiale di fissaggio- Kit de fijación 	1	USE	
QPOYP8x60Zn	Bolt -Schloss-schraube -Boulon- Bullone- Perno- M8x60mm PUP0 	8	StB1-1 StB1-2	
QULSI30x35	Cylinder- Zylinderschloss- Serrure a mortaiser- Serratura a cilindro- Bombin- 30.35 	1	TU28-16P	
QLIU KAPal	Door fittings- Türbeschlag- Ferrure- Ferramenta porta- Manilla puerta- QLIUKAPal 	1	TU28-16P	
QRV120	Keeper- Schliessblech- Tole- Lamiera- Aldaba de candado 	1	TU28-16P	
QNA2_2x50Zn	Nail- Nagel- Clou- Chiodo- Clavo- 2.5x50mm 	150	RB2-1	
QMUkk8Zn	Nut- Schraubenmutter- Écrou- Dado- Tuerca- M8mm 	8		
QKRPP2_5x16Zn	Screw- Schraube- Vis- Vite- Tornillo- 2.5x16mm 	2		

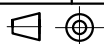

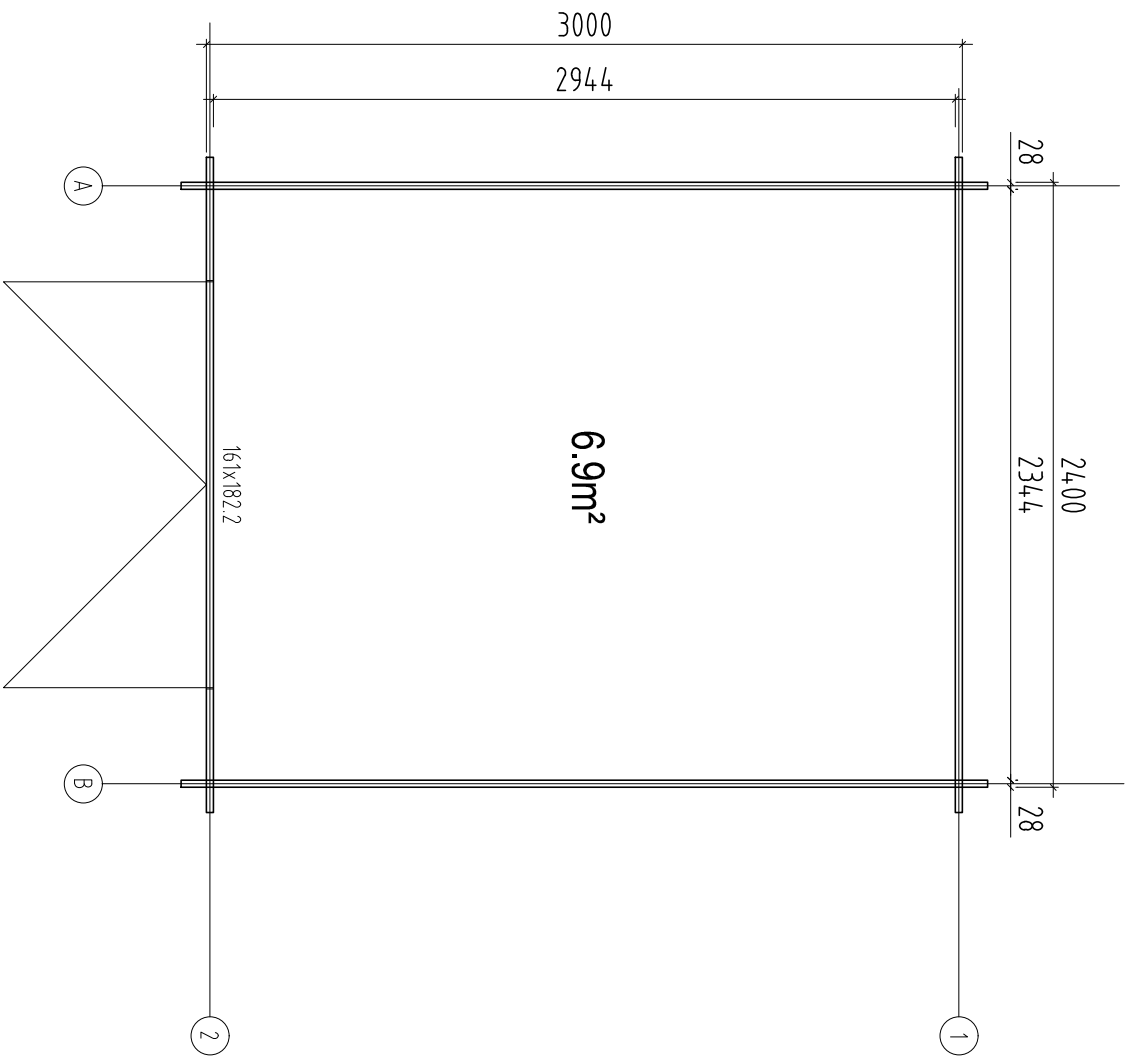

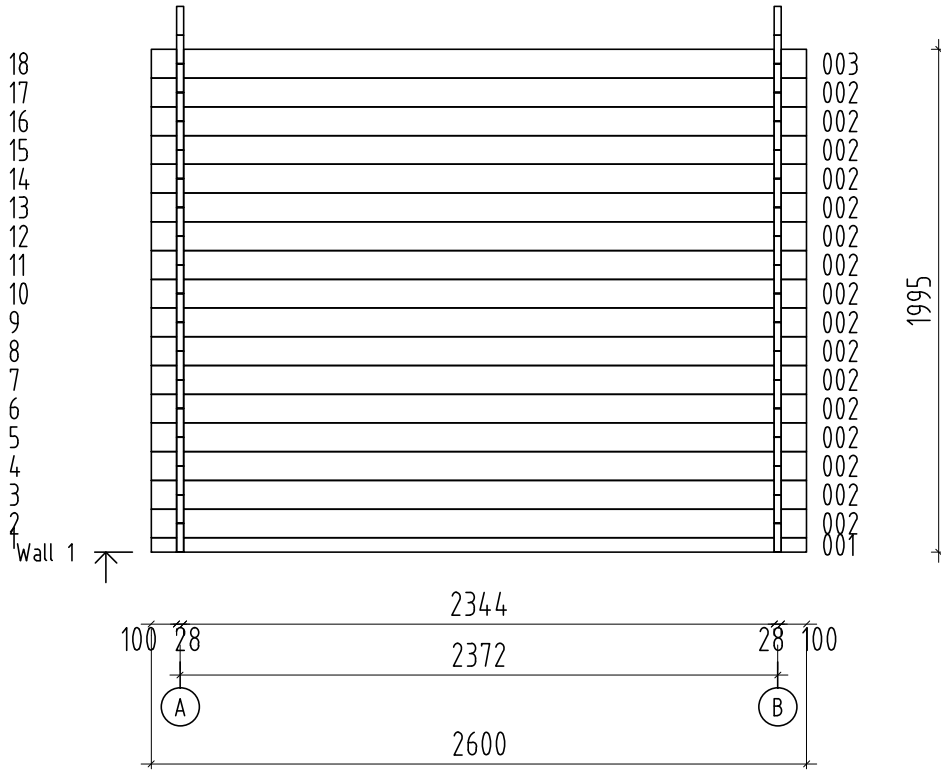

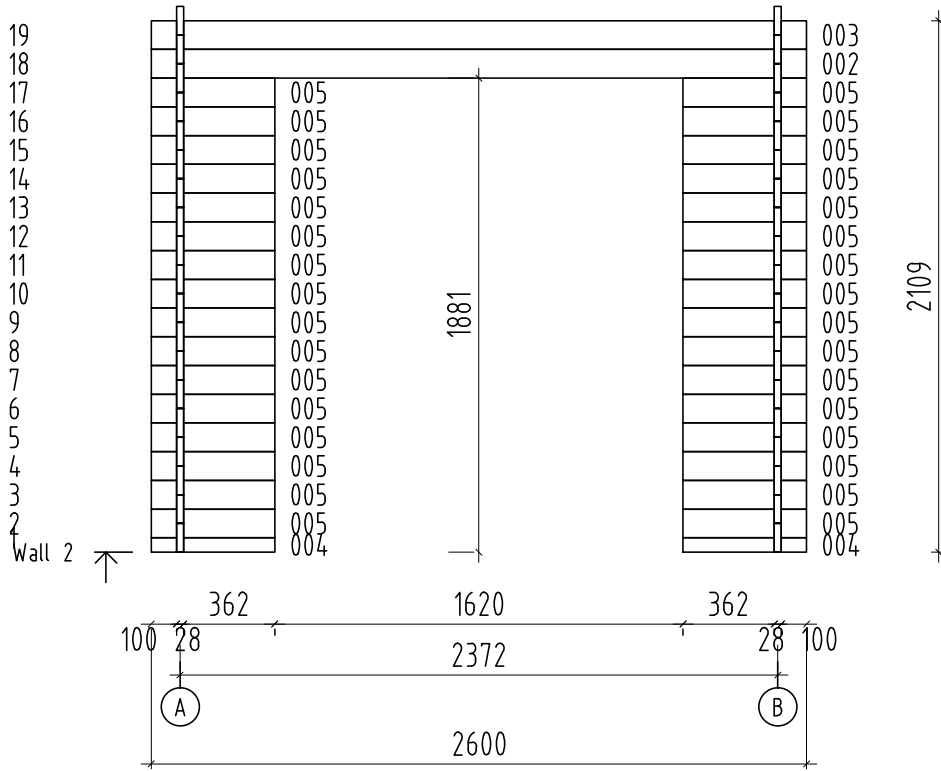

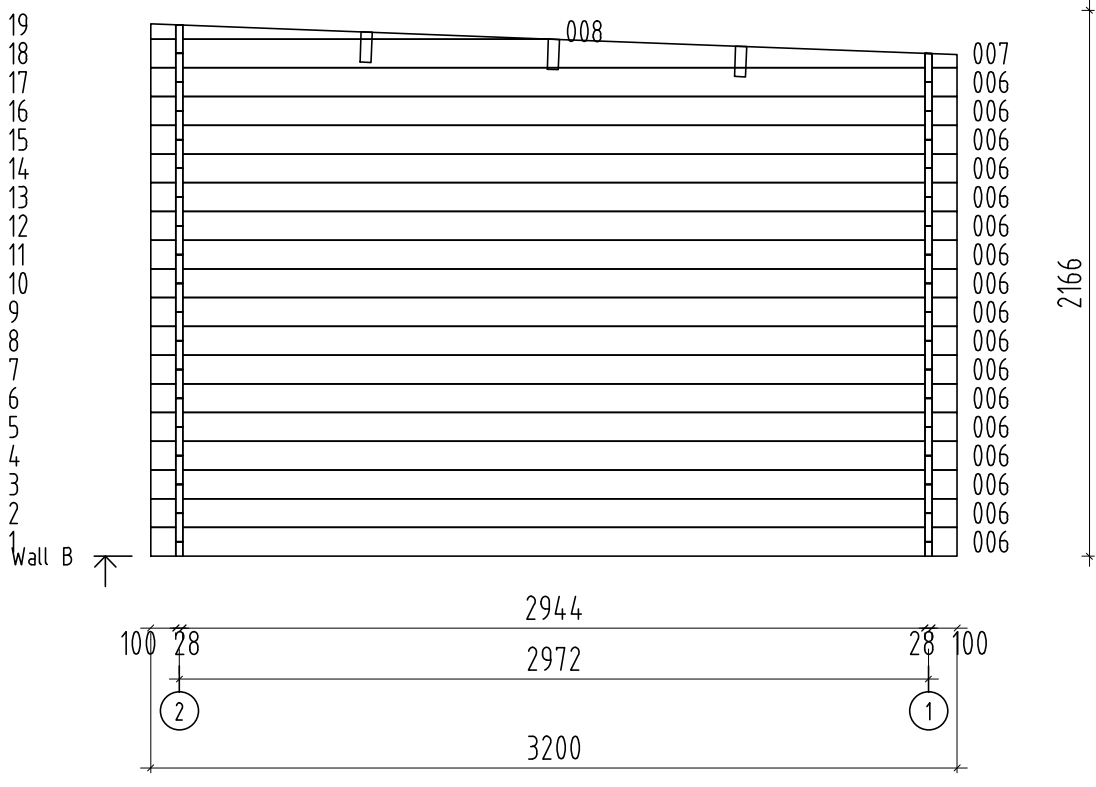

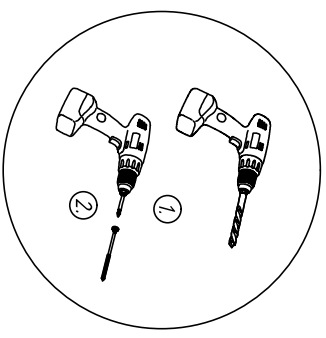
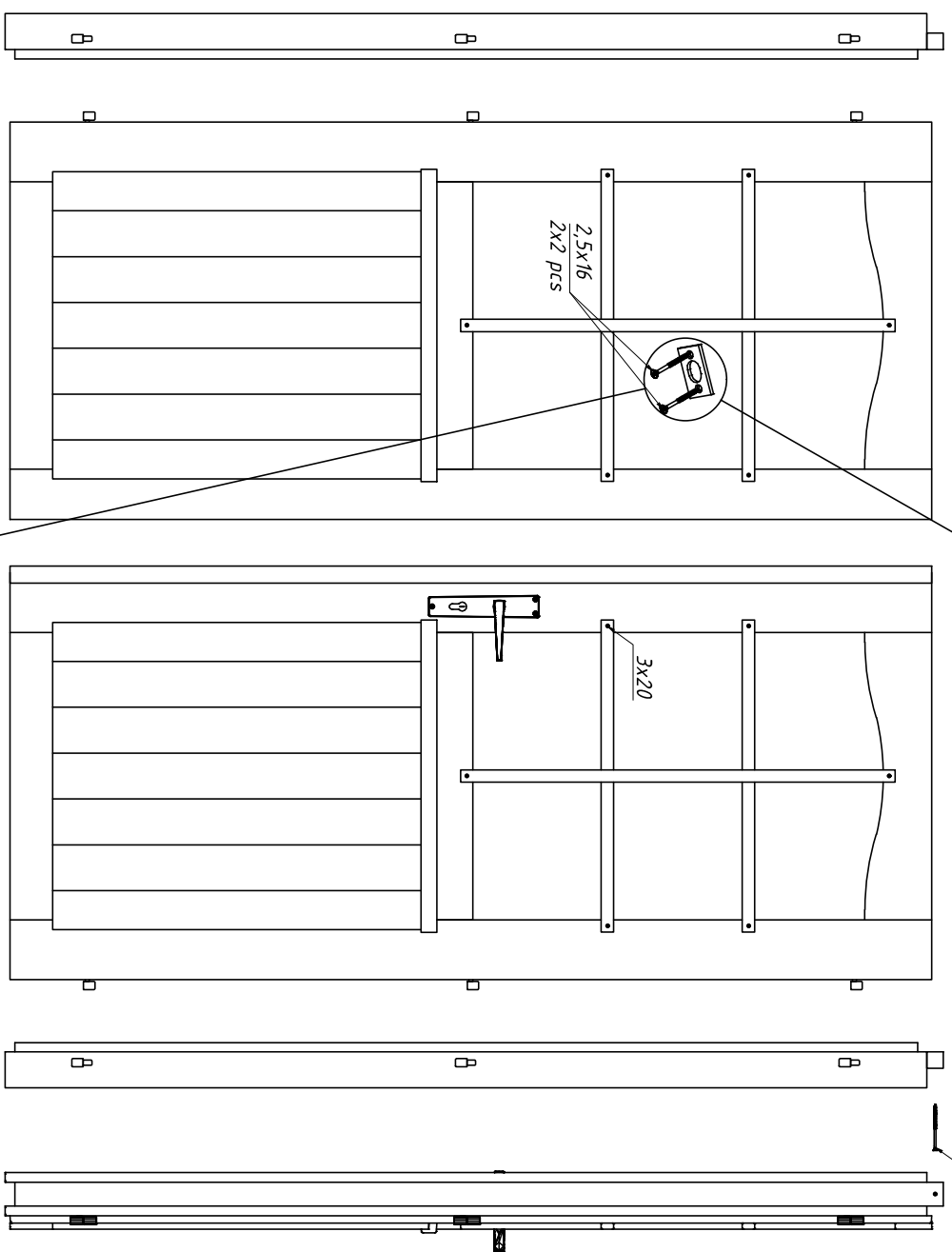
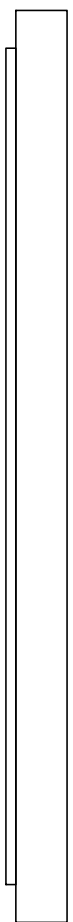
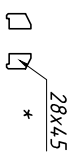
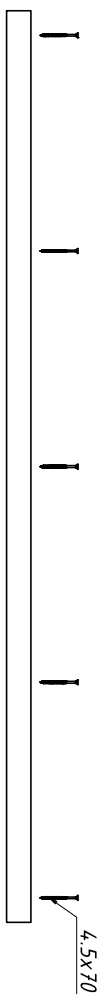

* The specification may vary depending on the specific model
 * Die Spezifikation können je nach Modell unterschiedlich sein
 * Les spécifications peuvent varier selon le modèle spécifique
 * Dependiendo del modelo, la especificación puede cambiar
 * Le specifiche possono variare a seconda del modello

