

Berkshire 53
Art. Nr. 4414840
1/10

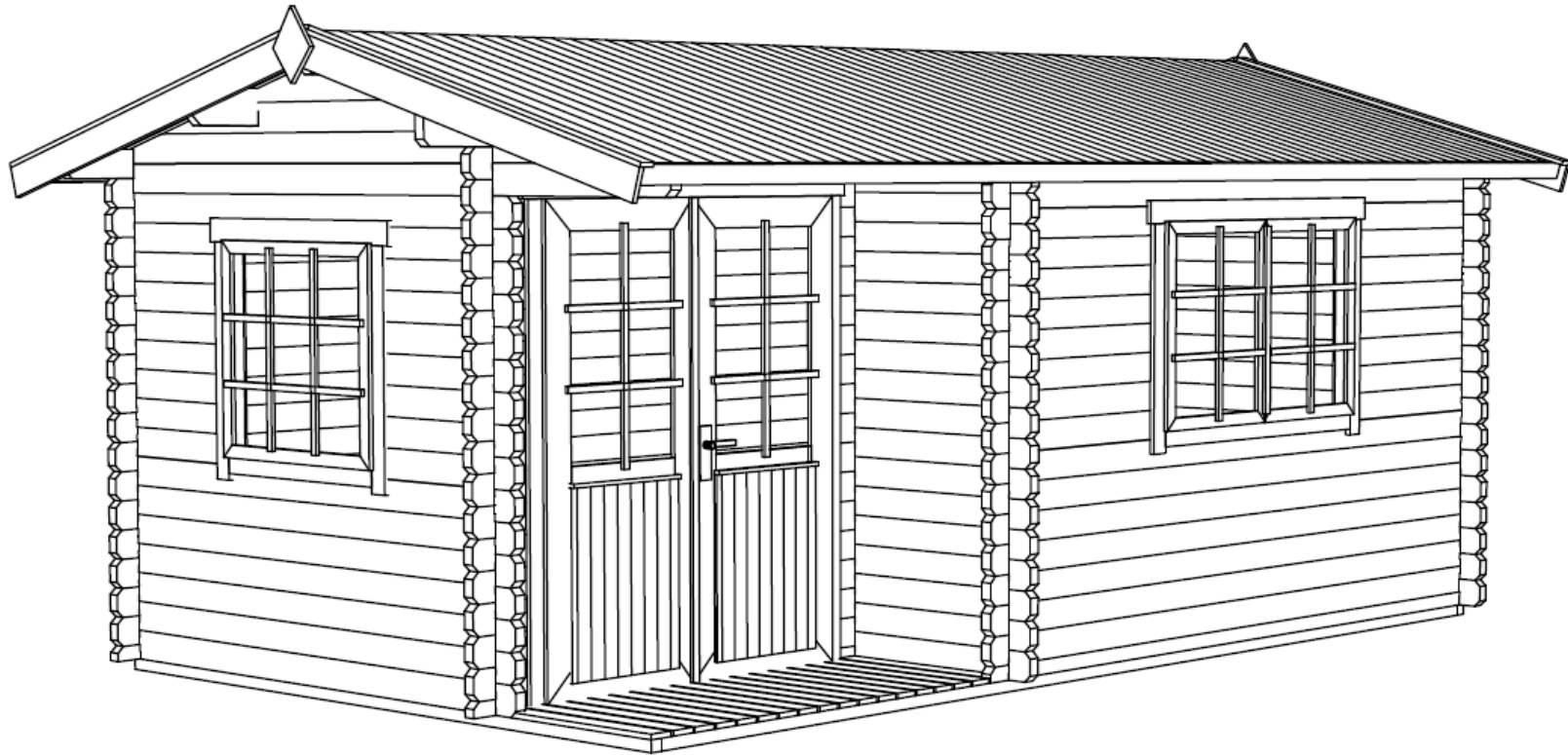

Art.Nr. 4414840

GROUNDPLAN - GRUNDPLAN - PLAN DE MASSE

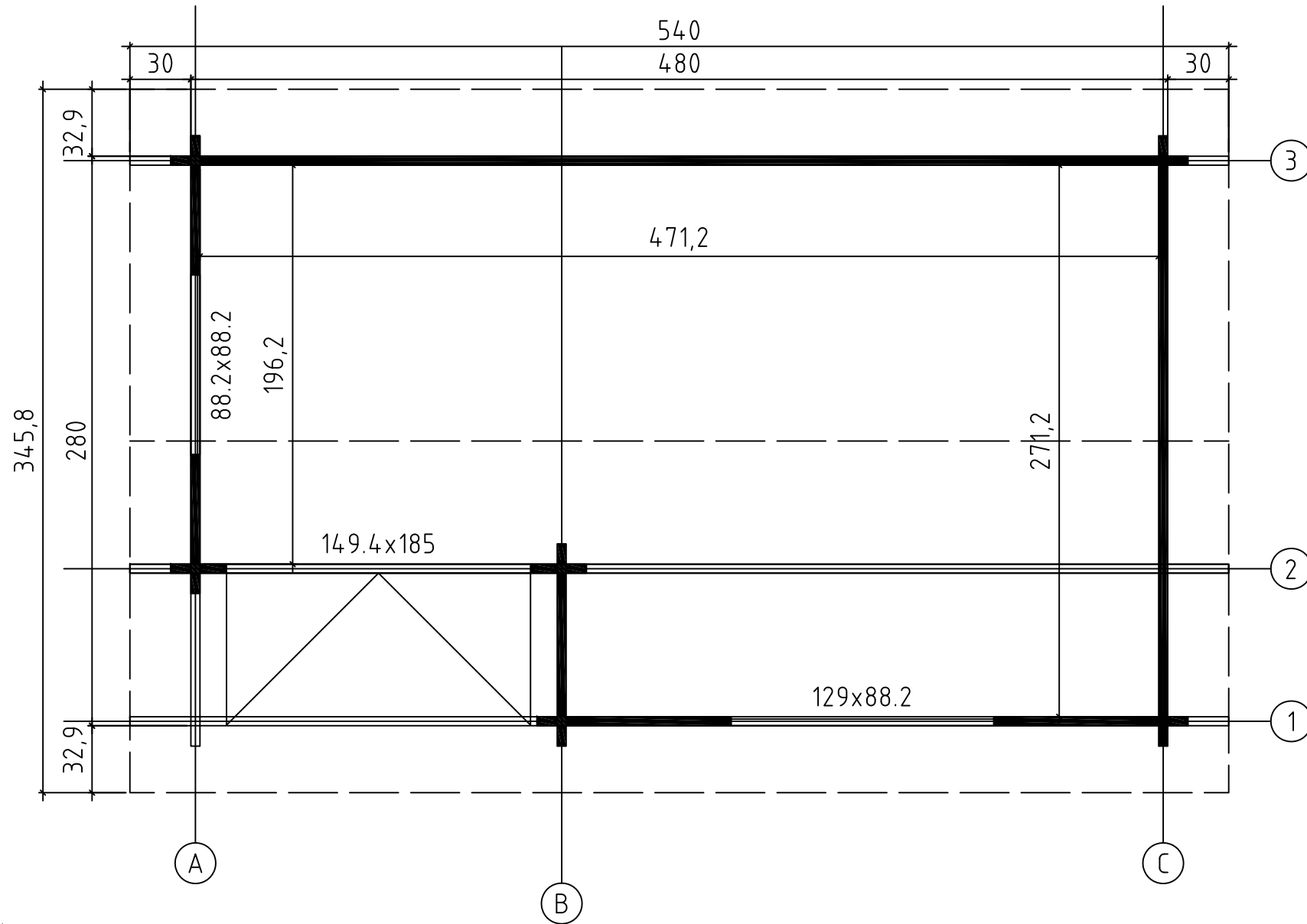

FOUNDATION - FUNDAMENT - FONDATION

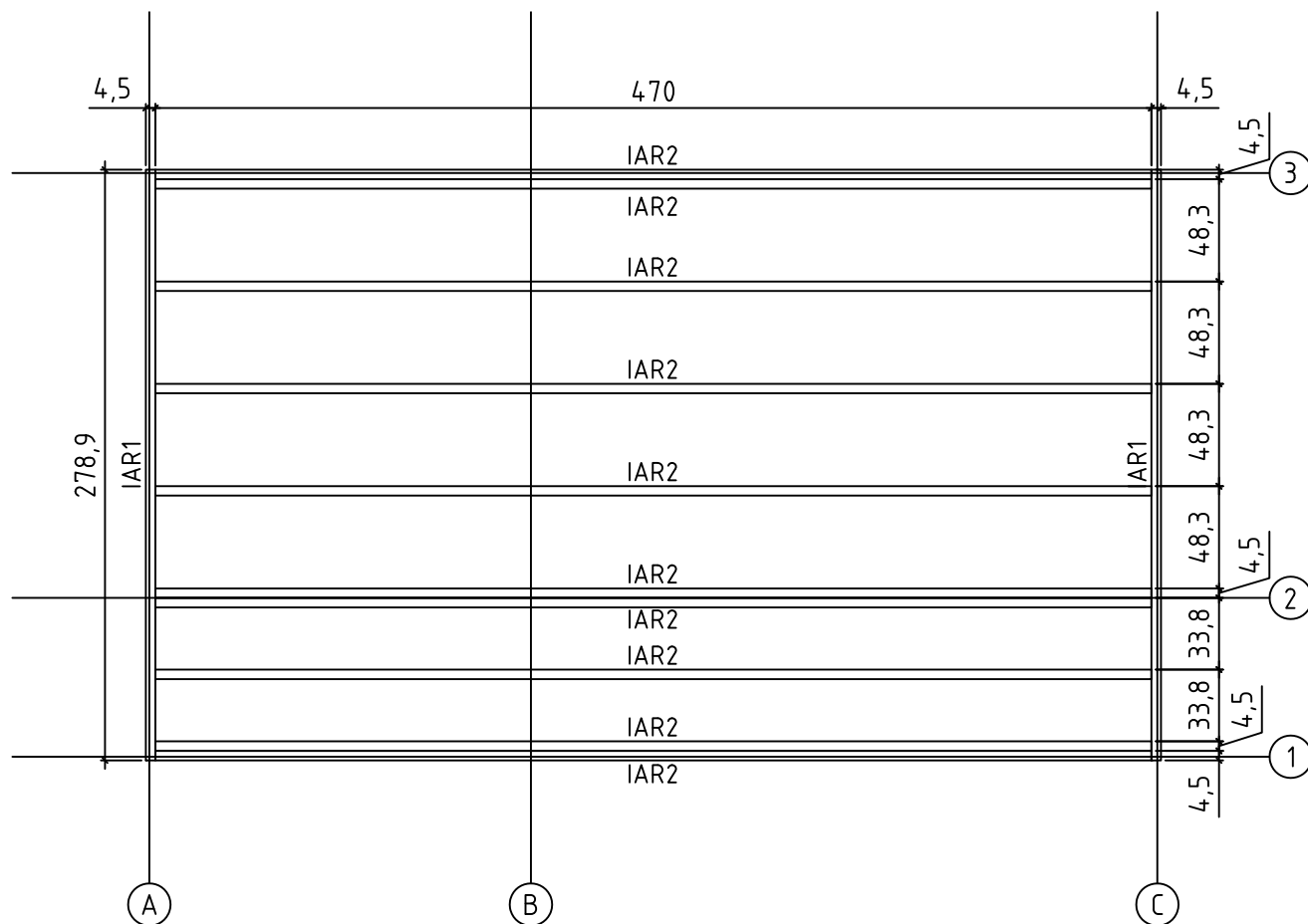



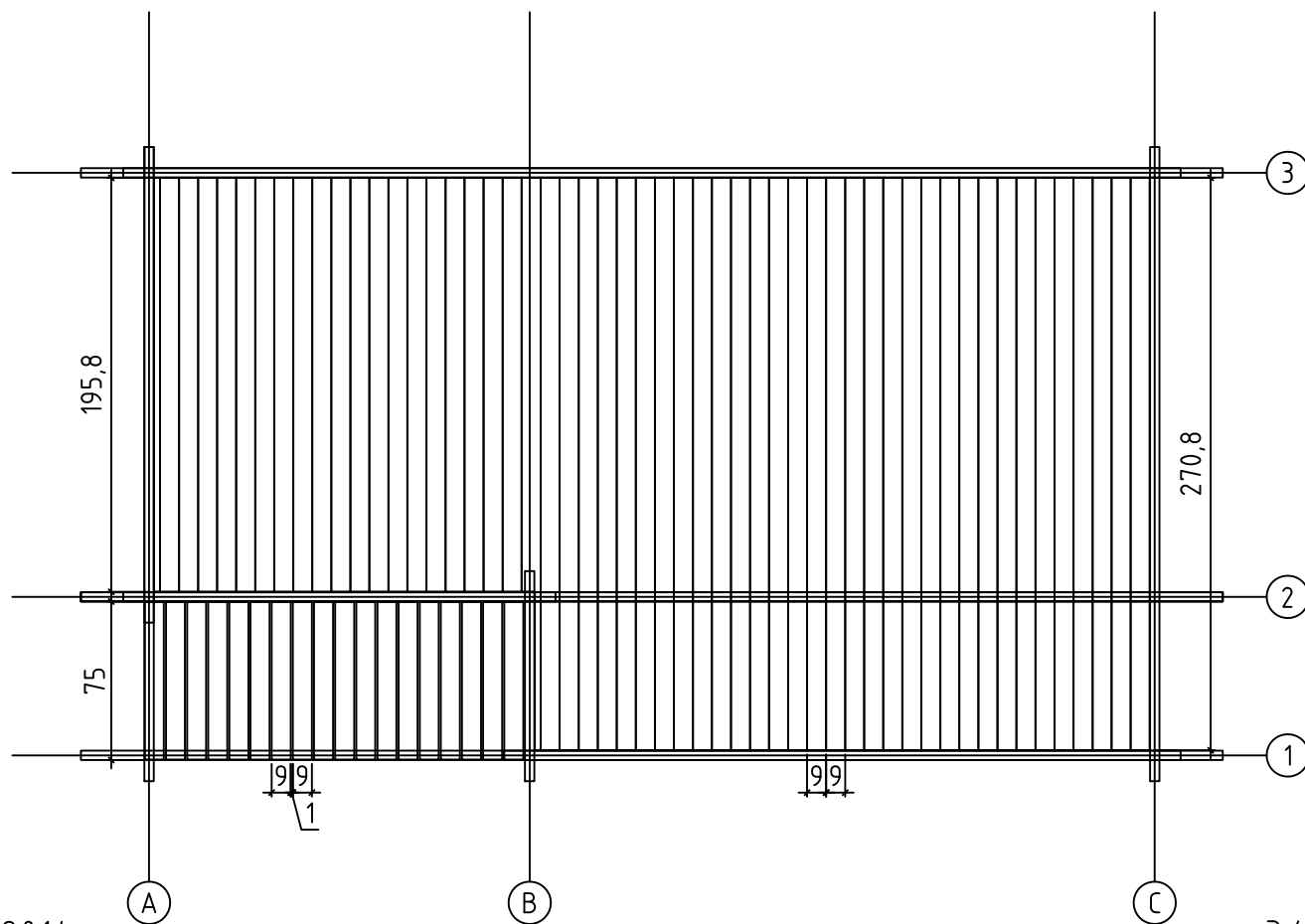

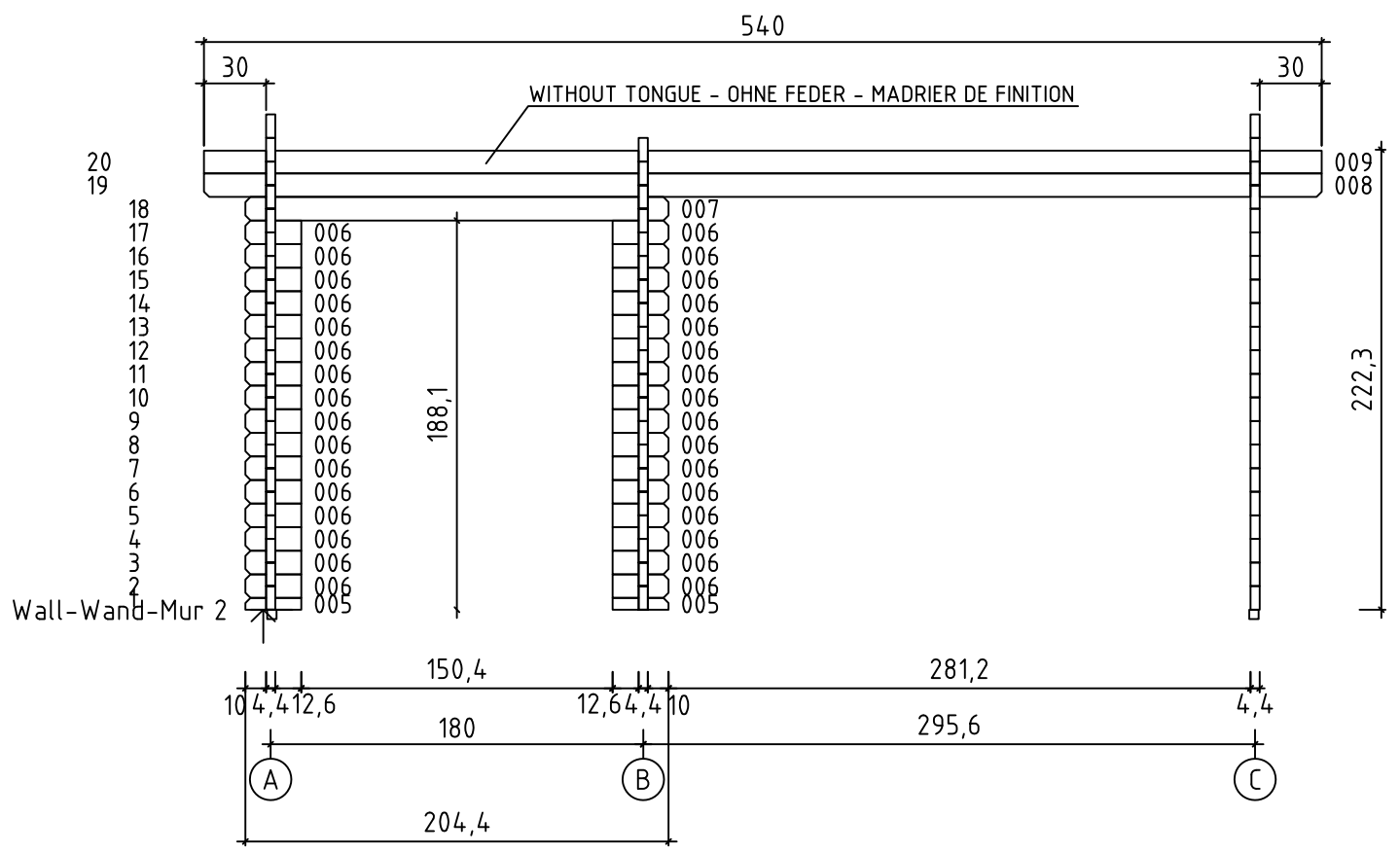
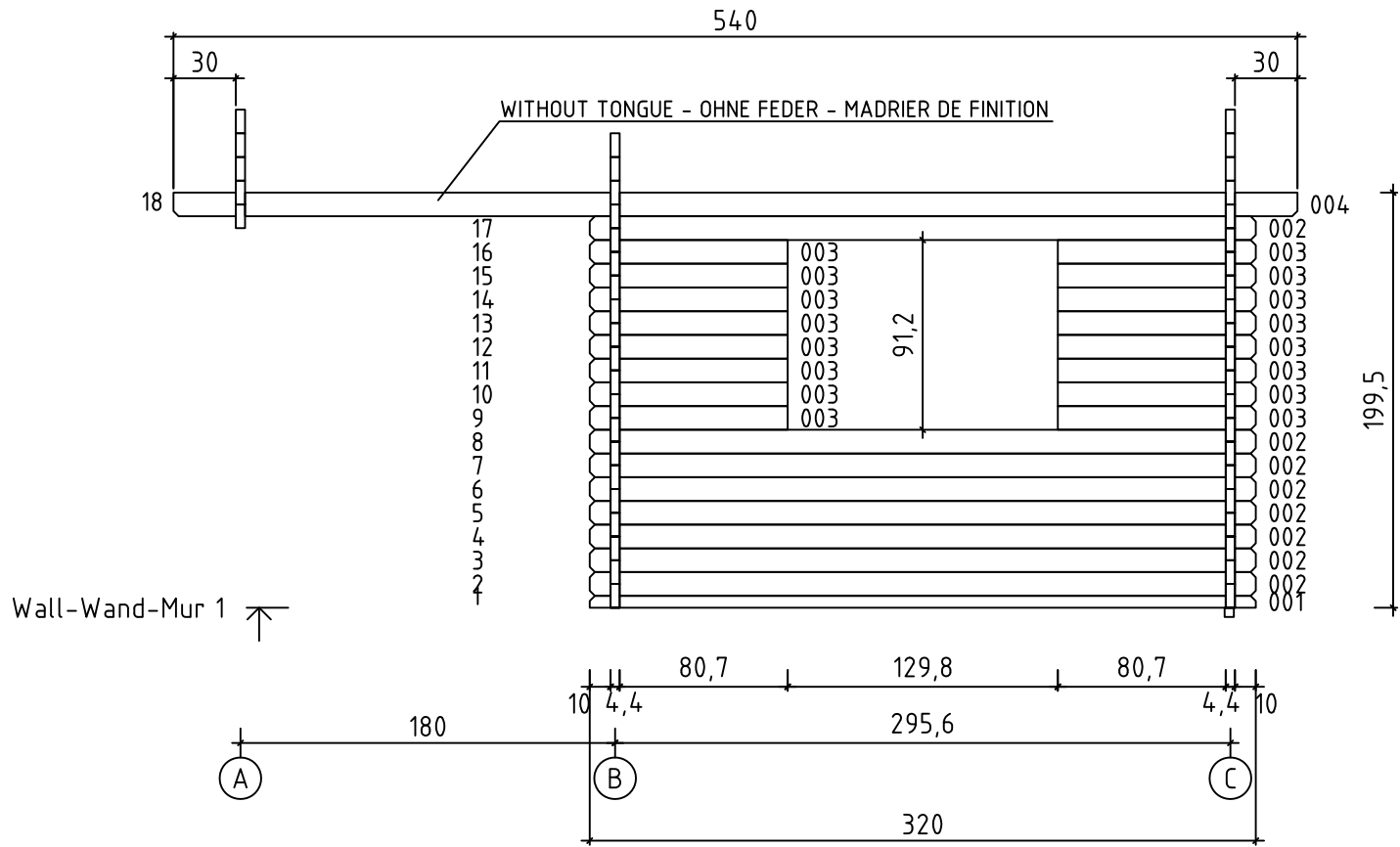

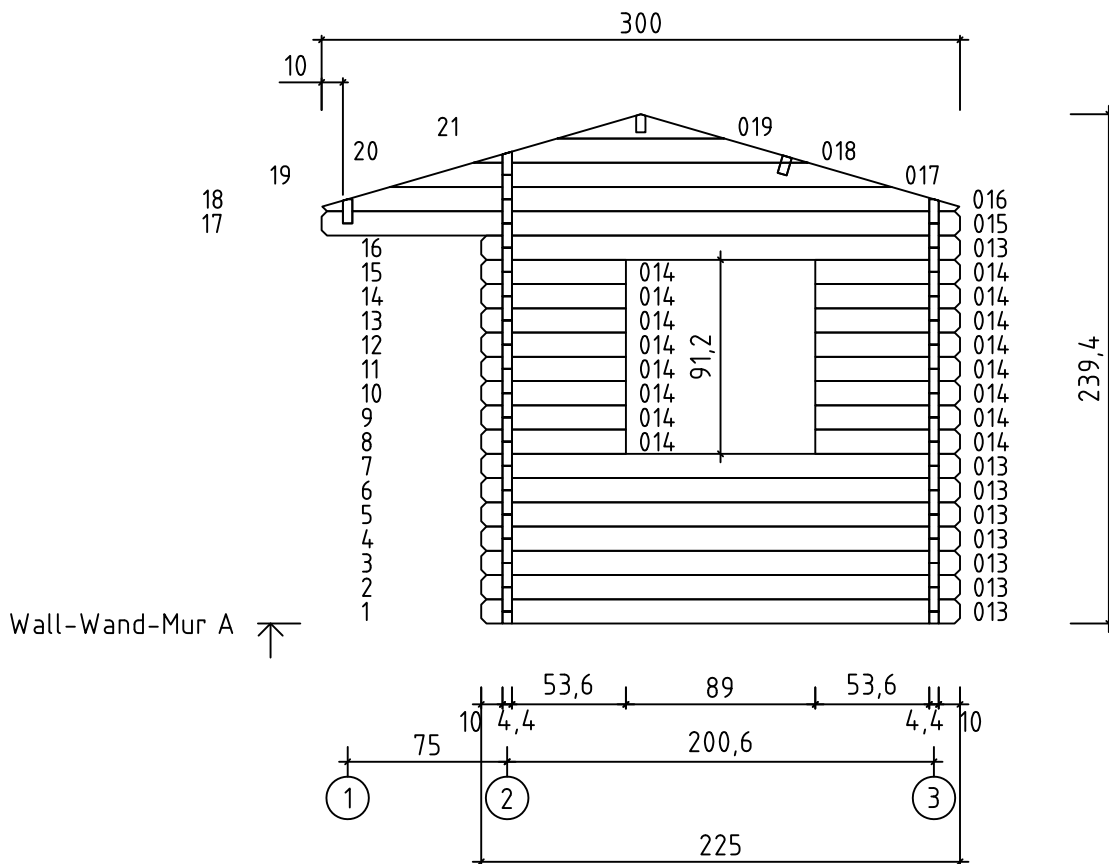
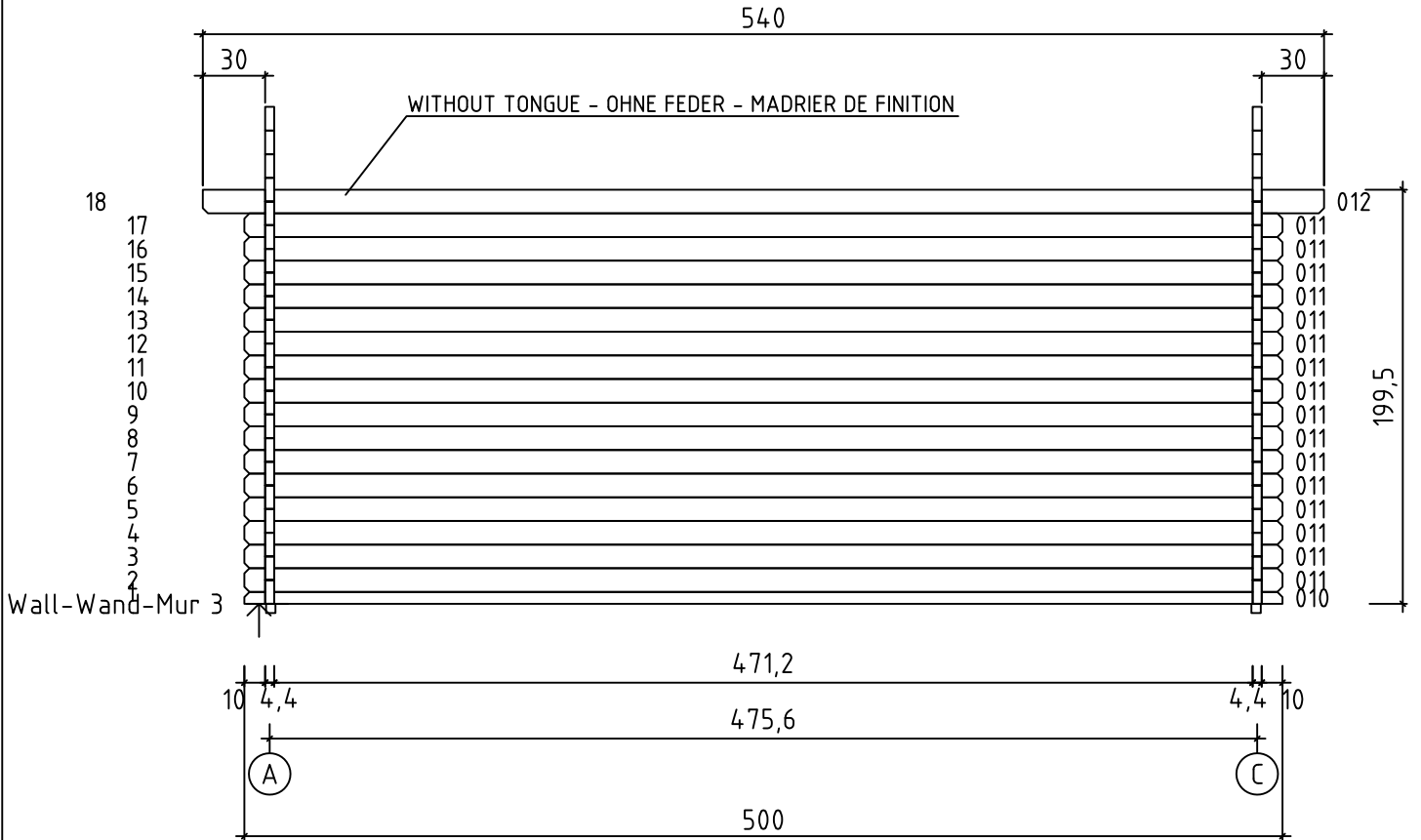
FLOOR BOARDS - FUSSBODENBRETTER - LAME DE PLANCHER
 TERRACE BOARDS - TERRASSENBRETTER - PLANCHER DE TERRASSE

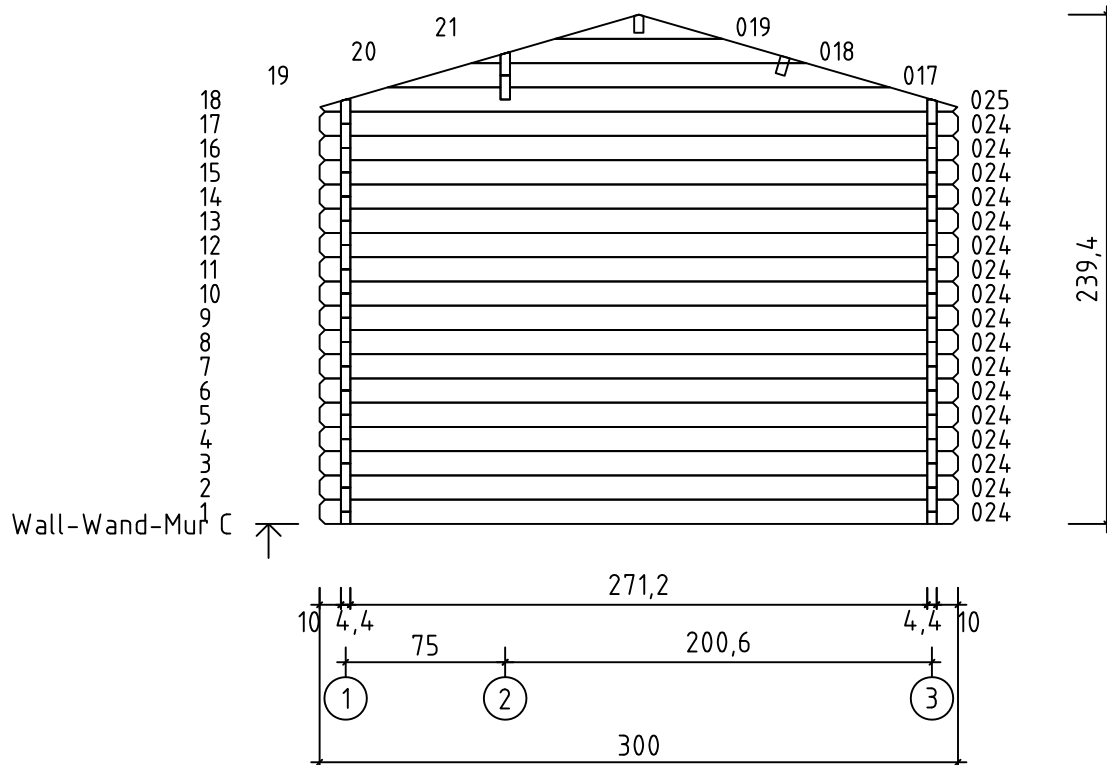
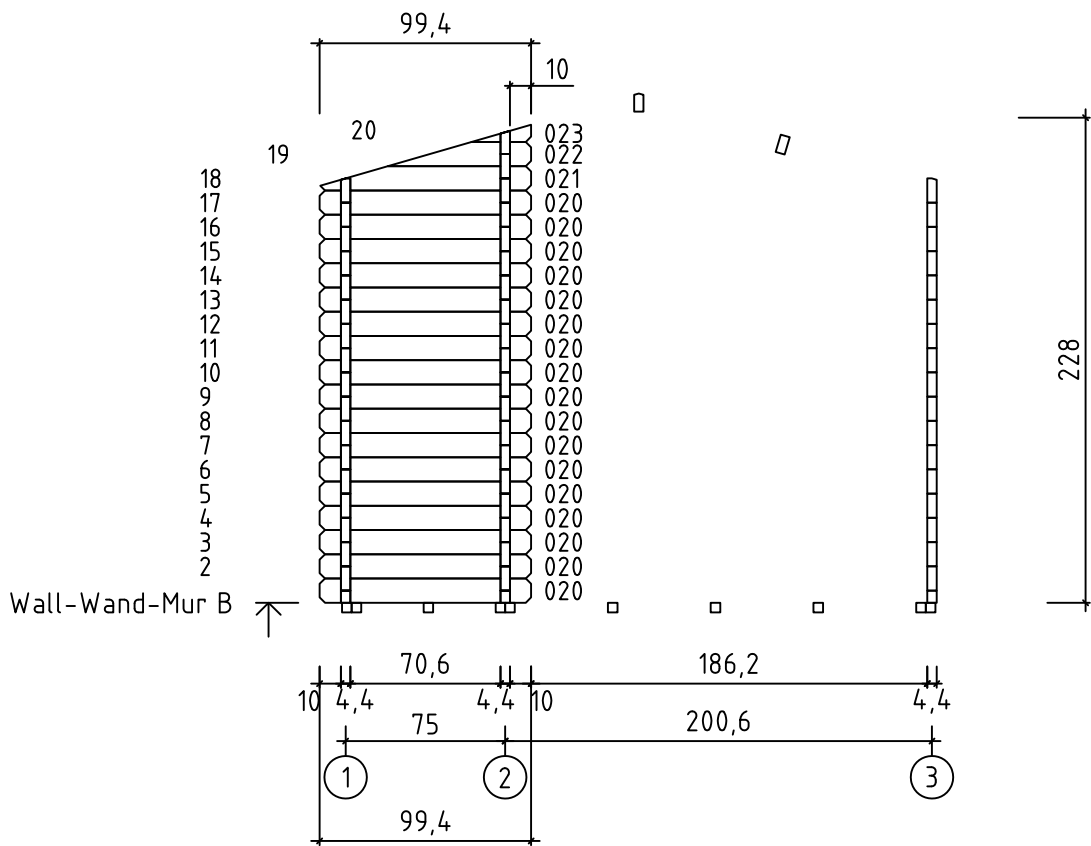

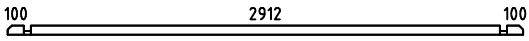
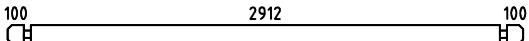
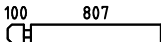
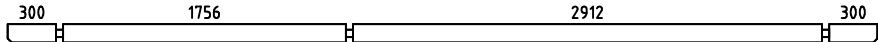



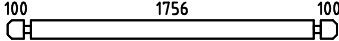
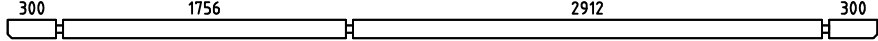
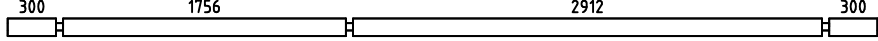
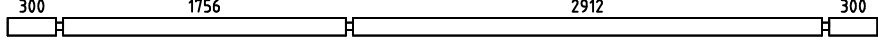
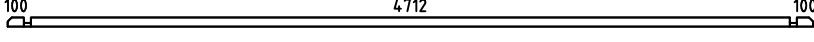
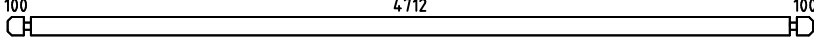
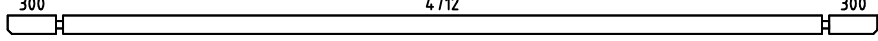
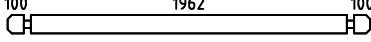
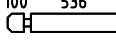
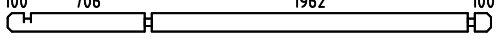
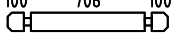
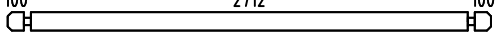
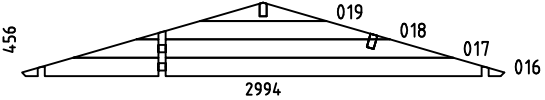
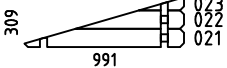
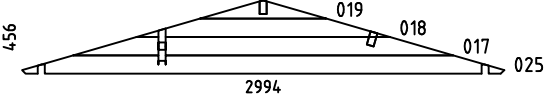



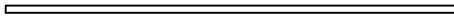
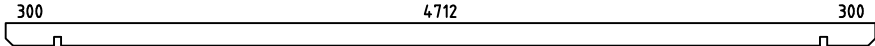
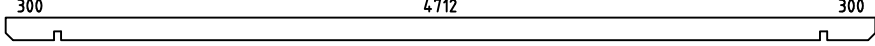





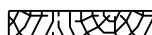

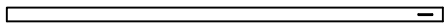

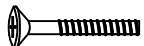





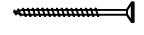







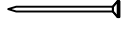

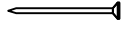

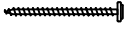
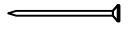

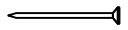
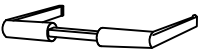

Pos	16.04.2014	Piece list - Stückliste - Liste des pièces Art.Nr. 4414840	7/10	Q.	P (mm)	L (mm)
001				1	44x57	3200
002				8	44x114	3200
003				16	44x114	951
004				1	44x120	5400
004a				1	44x120	5400
005				2	44x57	270
006				32	44x114	270
007				1	44x114	2044
008				1	44x114	5400
009				1	44x109	5400
009a				1	44x109	5400
010				1	44x57	5000
011				16	44x114	5000
012				1	44x120	5400
013				8	44x114	2250
014				16	44x114	680
015				1	44x114	3000
020				17	44x114	994
024				17	44x114	3000
WA-1				1		
WB-1				1		
WC-1				1		
IAR2		FOUNDATION - FUNDAMENT - FONDATION 		10	45x45	4700

Pos	16.04.2014	Piece list - Stückliste - Liste des pièces Art.Nr. 4414840	8/10	Q.	P (mm)	L (mm)
IAR1		FOUNDATION - FUNDAMENT - FONDATION 		2	45x45	2790
PR1		ROOF BEAM - DACHBALKEN - PANNE DE TOIT 4712 		1	44x140	5400
A.PR21		ROOF BEAM - DACHBALKEN - PANNE DE TOIT 4712 		1	44x140	5400
		FLOOR BOARDS - FUSSBODENBRETTER - LAME DE PLANCHER 		33	90x18	2708
		FLOOR BOARDS - FUSSBODENBRETTER - LAME DE PLANCHER 		20	90x18	1958
		ROOF BOARDS - DACHBRETTER - VOLIGES 		120	90x18	1800
SV		TERRACE BOARDS - TERRASSENBRETTER - PLANCHER DE TERRASSE 		18	90x19	750
FL		FLOOR FILLET-FUSSBODENLEISTE - CORNIERE DE FINITION DU PLANCHER 			18x18	14.83
DPL		ROOFING FELT FILLET - DACHPAPPENLEISTE - BAGUETTE DE FIXATION DU FEUTRE BITUMEUX 		4	18x58	1850
TB		EAVES BOARD - TRAUFBRETT - BANDEAU DE TOIT 		4	18x70	2700
DRV		ROOF EDGE REINFORCEMENT - DACHRANDVERSTÄRKUNG - CORNIERE DE RENFORT DE BORD DE TOIT 		4	28x34	2700
KFS		STORM PROTECTION - STURMLEISTE - LATTE ANTI-TEMPETE 		4	22x45	1900
GL		GABLE MOULDING - GIEBELLEISTE - PLANCHE DE RIVE 		4	18x120	1850
		BOLT FOR WINDOW HANDLE FITTINGS - BOLZEN FÜR FENSTERGRIFF BESCHLAG - BOULON POUR POIGNÉE D'OUVERTURE DE FENÊTRE 		4		
HS88		SCREW FOR GEORGIAN BARS - SCHRAUBE FÜR SPROSSEN - VIS DE BARRES GEORGIENNE 		32	2.5x20	
HS12		SCREW FOR GABLE SEGMENT - SCHRAUBEN FÜR DECKBLATT - VIS POUR FIXATION LOSANGE DE FINITION 		4	3.5x35	
HS16		SCREW FOR GABLE MOULDING - SCHRAUBEN FÜR GIEBELLEISTE - VIS DE FIXATION POUR PLANCHE DE RIVE 		32	3.5x50	
HS3		SCREW FOR WINDOW FILLET - SCHRAUBE ZUR BEFESTIGUNG FENSTERLEISTE - VIS D'ASSEMBLAGE DU CADRE DE FENÊTRE 		3	3x30	
HS3		SCREW FOR DOOR FILLET - SCHRAUBE ZUR BEFESTIGUNG TÜRLEISTE - VIS D'ASSEMBLAGE DU CADRE DE PORTE 		5	3x30	
HS32		SCREW FOR EAVES BOARDS - SCHRAUBEN FÜR TRAUFBRETTER - VIS DE FIXATION POUR BANDEAU DE TOIT 		24	4x40	
HS26		SCREW FOR ROOF EDGE REINFORCEMENT - SCHRAUBEN FÜR DACHRANDVERSTÄRKUNG - VIS POUR RENFORT DE BORD DE TOIT 		24	4x40	
HS43		SCREW FOR ROOF BEAMS - SCHRAUBEN FÜR DACHBALKEN - VIS POUR PANNE DE TOIT 		16	5x120	
HS42		SCREW FOR GABLE - SCHRAUBEN FÜR GIEBEL - VIS POUR FIXATION DES PIGNONS 		16	5x120	
HS40		SCREW FOR 1. WALL BEAM - SCHRAUBE FÜR 1. BOHLENREIHE - VIS DE FIXATION DES FONDATIONS 		10	5x90	
HS39		SCREW FOR FUNDAMENT - SCHRAUBEN ZUR BEFISTIGUNG FUNDAMENT - VIS POUR FONDATION 		32	5x90	

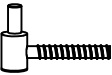
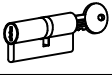
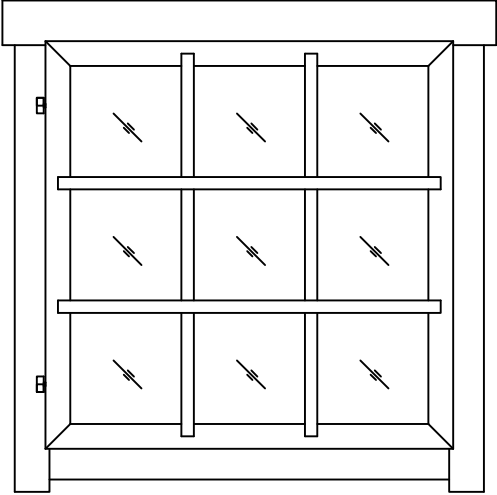
Pos	16.04.2014	Piece list - Stückliste - Liste des pièces Art.Nr. 4414840	9/10	Q.	P (mm)	L (mm)
HS41		SCREW FOR DOOR JAMB - SCHRAUBE FÜR TÜRRAHMEN - VIS DE FIXATION POUR MONTANT DE PORTE		4	5x90	
NF3		ZN NAIL FOR TERRACE - ZN NÄGEL FÜR TERRASSENBRETT - POINTE POUR PLANCHER DE TERRASSE		108	2.1x50	
FS3		WINDOW HANDLE FITTINGS-FENSTERGRIFF - POIGNÉE D'OUVERTURE DE FENETRE		1		
FS2		WINDOW HANDLE FITTINGS-FENSTERGRIFF - POIGNÉE D'OUVERTURE DE FENETRE		1		
NFF		ZN NAIL FOR FLOOR FILLET - ZN NÄGEL FÜR FUSSBODENLEISTE - POINTE POUR CORNIERE DE FINITION DU PLANCHER		34	1.4x40	
SH44		HAMMER BLOCK - SCHLAGHOLZ - CALLE DE FRAPPE		1		
MS		SCREW FOR DOORSTEP - SCHRAUBEN FÜR TÜRSCHWELLE - VIS DE FIXATION DU SEUIL DE PORTE		3	4.5x65	
NFD		ZN NAIL FOR ROOFING FELT FILLET - ZN NÄGEL FÜR DACHPAPPENLEISTE - POINTE POUR BAGUETTE FIXATION FEUTRE BITUMEUX		24	2x40	
GS		GABLE SEGMENT-DECKBLATT - LOSANGE DE FINITION		2		
SFS		NUT FOR STORM PROTECTION - SCHRAUBENMUTTER FÜR STURMLEISTE - ÉCROU POUR LAME ANTI-TEMPETE		8		
BFS		BOLT FOR STORM PROTECTION - BOLZEN FÜR STURMLEISTE - VIS POUR LAME ANTI-TEMPETE		8		
DFS		WASHER FOR STORM PROTECTION - DICHTSCHEIBE FÜR STURMLEISTE - RONDELLE POUR LAME ANTI-TEMPETE		8		
NF2		ZN NAIL FOR ROOF - ZN NÄGEL FÜR DACHBRETT - POINTE POUR TOIT		398	2x50	
NH1		ZN NAIL FOR FLOOR - ZN NÄGEL FÜR FUSSBODENBRETT - CLOUS POUR PLANCHER		336	2x50	
TS3		DOOR HANDLE FITTINGS-TÜRGRIF - SET DE GARNITURES DE SERRURE DE PORTE		1		
TS4		SET OF DOOR LOCK COVERS - SCHLOSSBLENDEN - SET DE GARNITURES DE SERRURE DE PORTE		1		
TS2		MALE BOLT HINGE FOR DOOR - TÜRRIEGEL - PARTIE MALE DE CHARNIERE DE PORTE		6		
TS6		CYLINDER LOCK -ZYLINDERSCHLOSS - CYLINDRE DE SERRURE		1		
		WINDOW - FENSTER - FENETRE 882x882 AK.1.109.PVV.b	DGP	1		
						

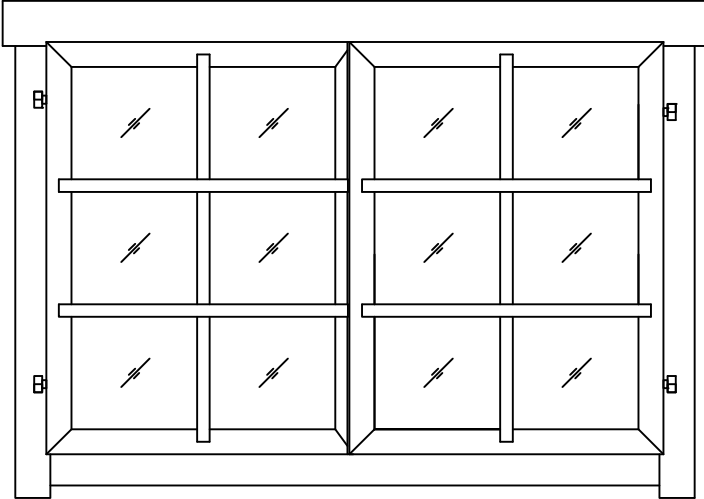
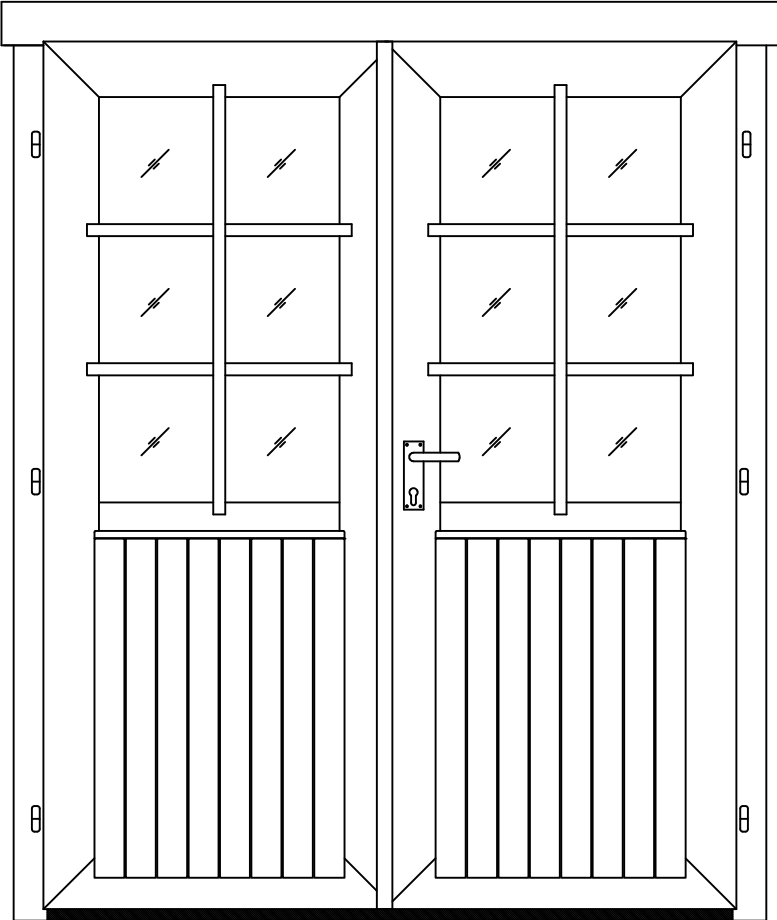
Pos	16.04.2014 Piece list - Stückliste - Liste des pièces Art.Nr. 4414840	10/10	Q.	P (mm)	L (mm)
	<p data-bbox="188 136 702 165">WINDOW - FENSTER - FENETRE 1290x882</p> <p data-bbox="837 136 1032 165">TAK.1106.PVP.a</p> <p data-bbox="1137 136 1193 165">DGP</p> 	1			
	<p data-bbox="217 889 632 918">DOOR - TÜR - PORTE 1494x1850</p> <p data-bbox="810 889 1082 918">TUK.2.056.PVP.MMWc</p> <p data-bbox="1137 889 1193 918">DGP</p> 	1			