

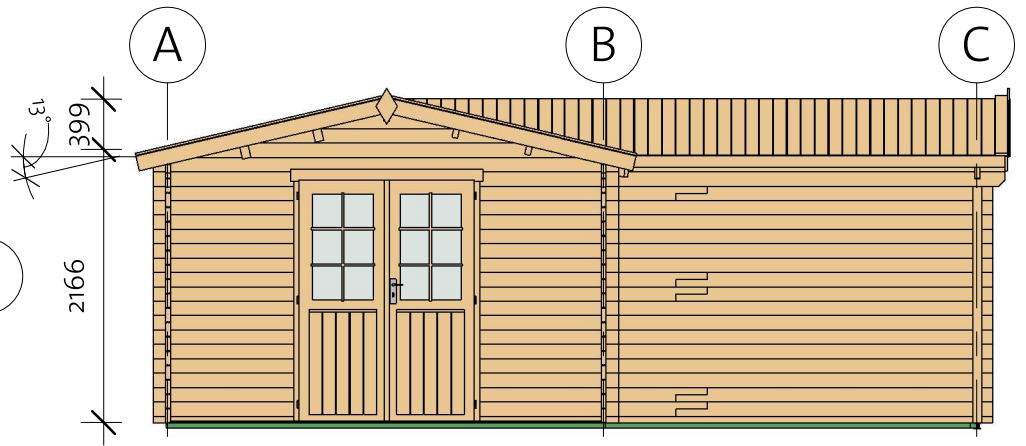

Callsen 40 (646x480)

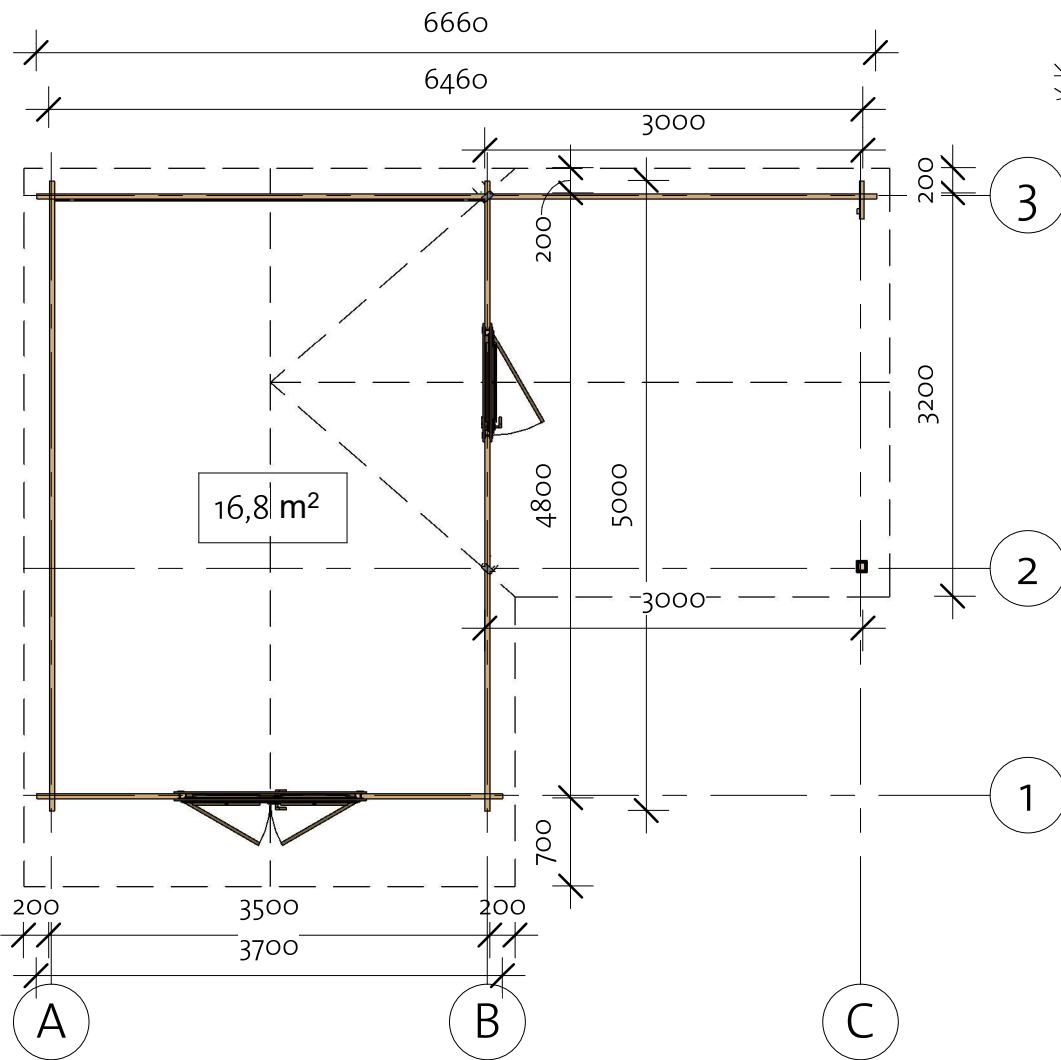
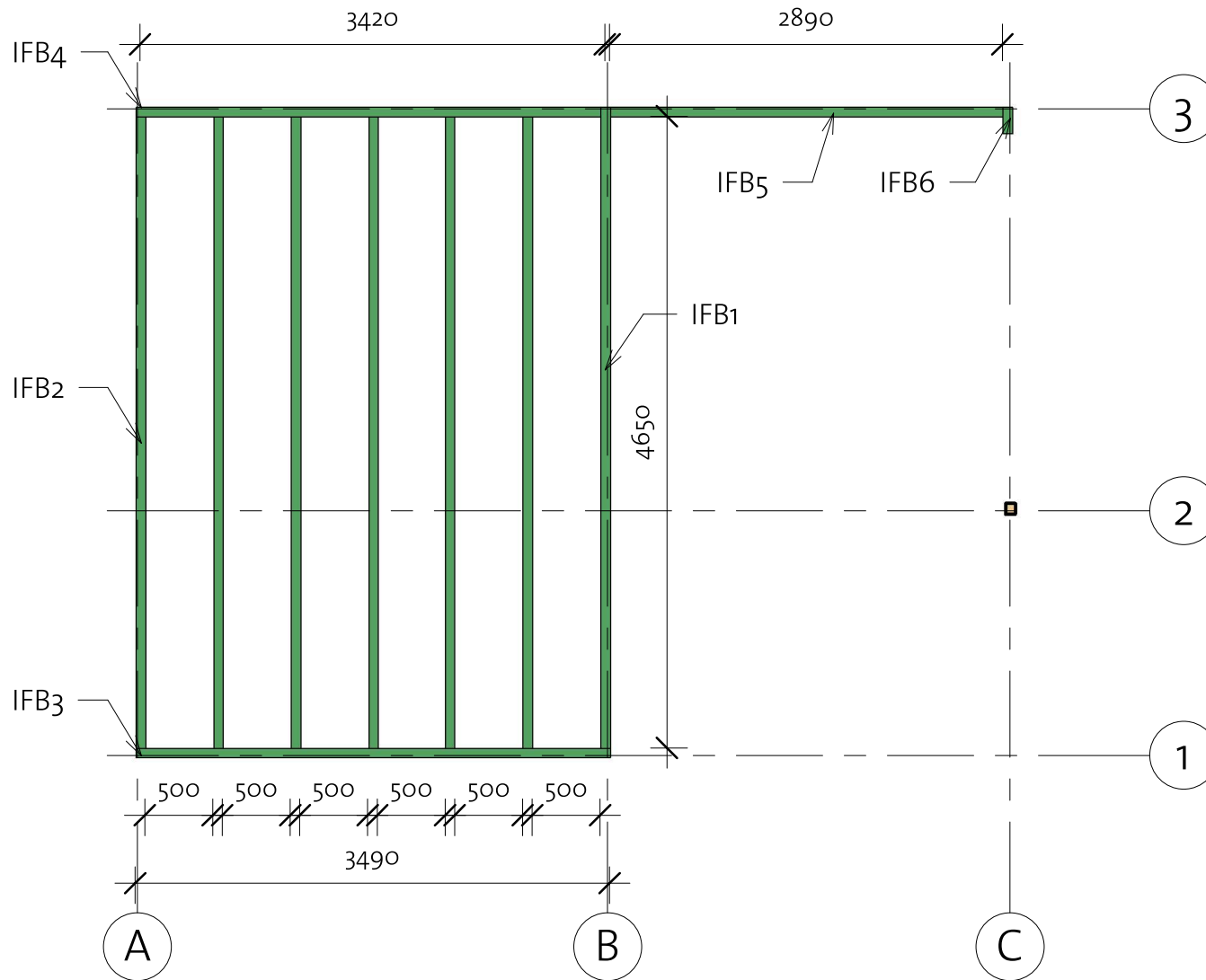

Callsen 40 (646x480)

Foundation



Impregnated foundation beams				
Mark	Type	Profile	Count	Length
IFB1	IFB 70x40		1	4720
IFB2	IFB 70x40		6	4650
IFB3	IFB 70x40		1	3490
IFB4	IFB 70x40		1	3420
IFB5	IFB 70x40		1	2890
IFB6	IFB 70x40		1	195

Callsen 40 (646x480)

Floor Plan

① Baseboard

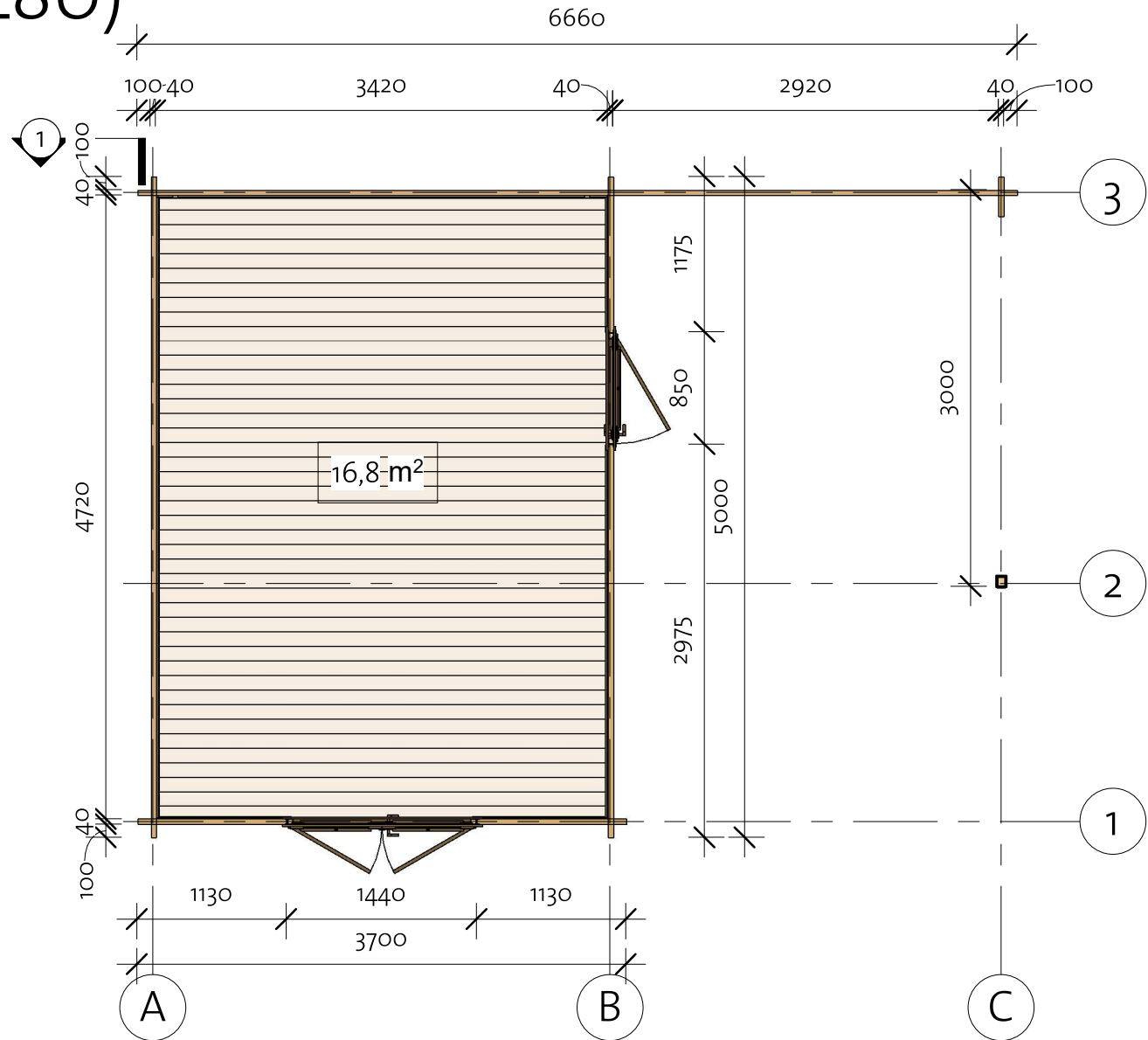
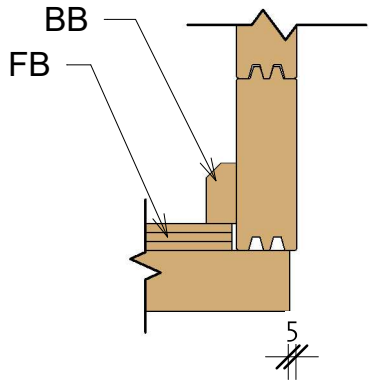

Floor Schedule

Mark	Type	Profile	Count	Length
------	------	---------	-------	--------

FB	FB 18x110		44	3414
----	-----------	---	----	------

BB1	BB 20x40		2	4800
BB2	BB 20x40		2	3500

Callsen 40 (646x480)

Wall 1

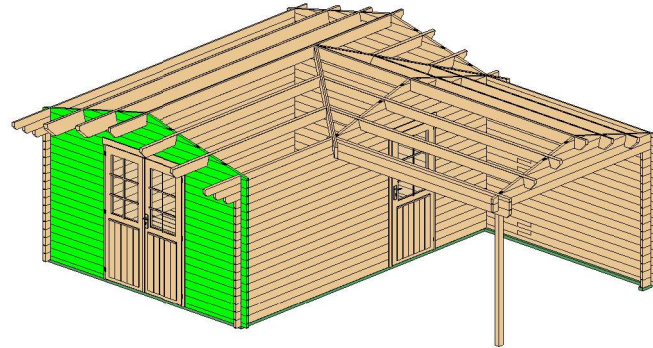

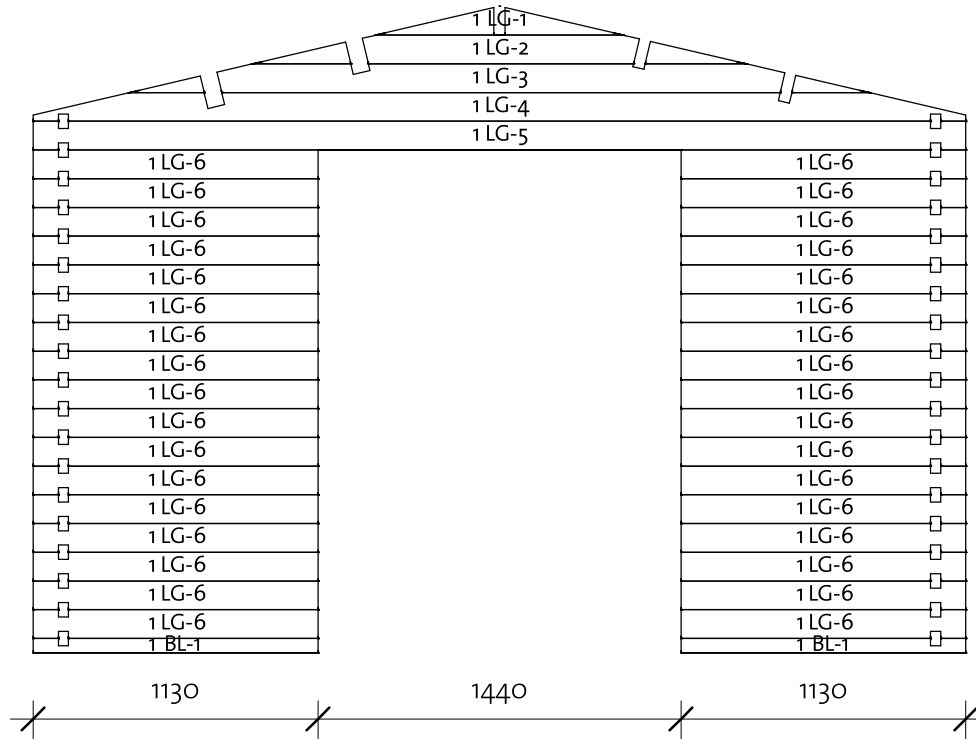

Wall 1			
Mark	Profile	Count	Cut Length
1BL-1	40X57	2	1130
1LG-1 *	40X114	1	978
1LG-2 *	40X114	1	1955
1LG-3 *	40X114	1	2932
1LG-4 *	40X114	1	3700
1LG-5	40X114	1	3700
1LG-6	40X114	34	1130

* Gable - delivered premounted



Log Profile Wall 1	
Profile	Profile

40X57	
40X114	

Callsen 40 (646x480)

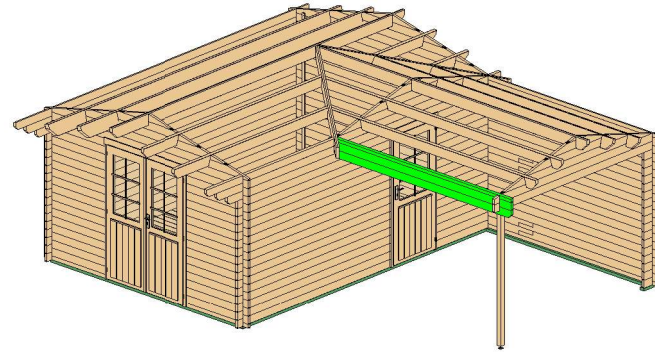

Wall 2



Wall 2			
Mark	Profile	Count	Cut Length

2LG-1	40x114	1	3300
2LG-2	40x114	1	3300
2TL-1	40x57	1	3166

Log Profile Wall 2	
Profile	Profile

40x57	
40x114	

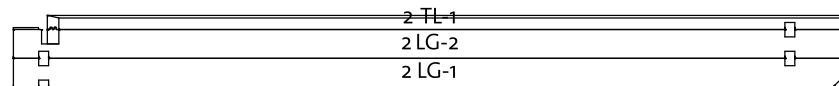

Callsen 40 (646x480)

Wall 3

Wall 3			
Mark	Profile	Count	Cut Length

3BL-1	40x57	1	3080
3BL-2	40x57	1	3580
3LG-1*	40x114	1	978
3LG-2*	40x114	1	1955
3LG-3*	40x114	1	2932
3LG-4*	40x114	1	3572
3LG-5	40x114	1	3580

Wall 3			
Mark	Profile	Count	Cut Length

3LG-6	40x114	11	3580
3LG-7	40x114	1	3180
3LG-8	40x114	1	2610
3LG-9	40x114	7	3080
3LG-10	40x114	6	4400
3LG-11	40x114	5	2510
3LG-12	40x114	4	3080
3TL-1	40x57	1	3166

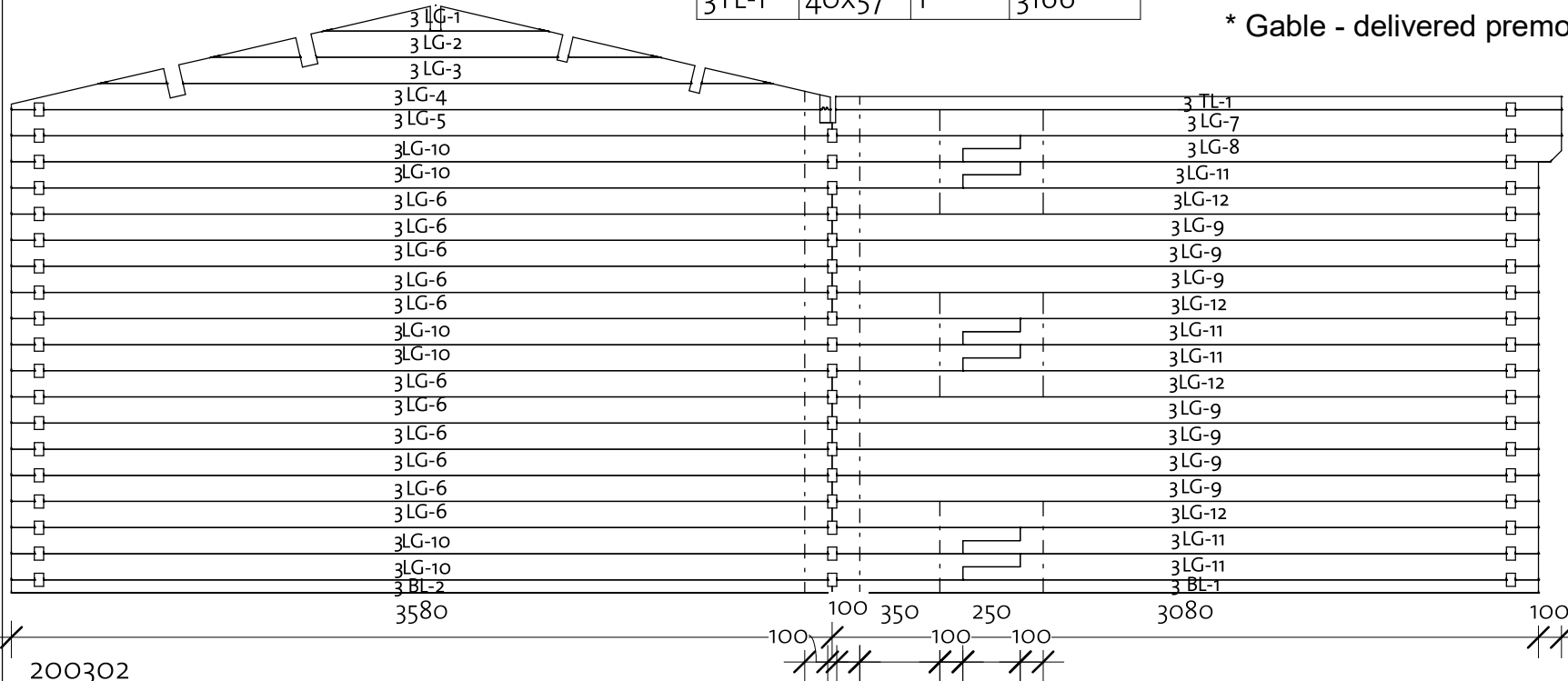
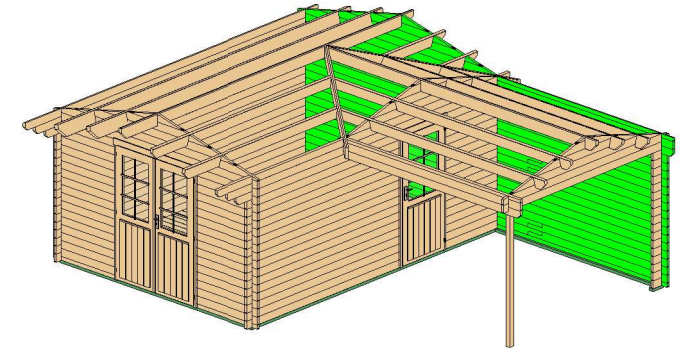

* Gable - delivered premounted

Log Profile Wall 3	
Profile	Profile

40x57	
40x57	
40x114	

Callsen 40 (646x480)

Wall A

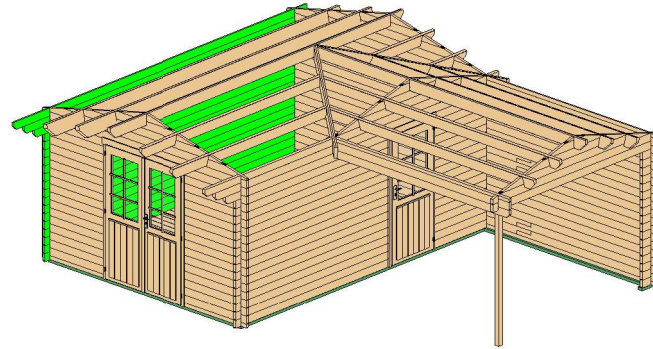

Wall A			
Mark	Profile	Count	Cut Length

ALG-1	40X114	16	5000
ALG-2	40X114	1	5200
ALG-3	40X114	1	5400
ATL-1	40X114	1	5700

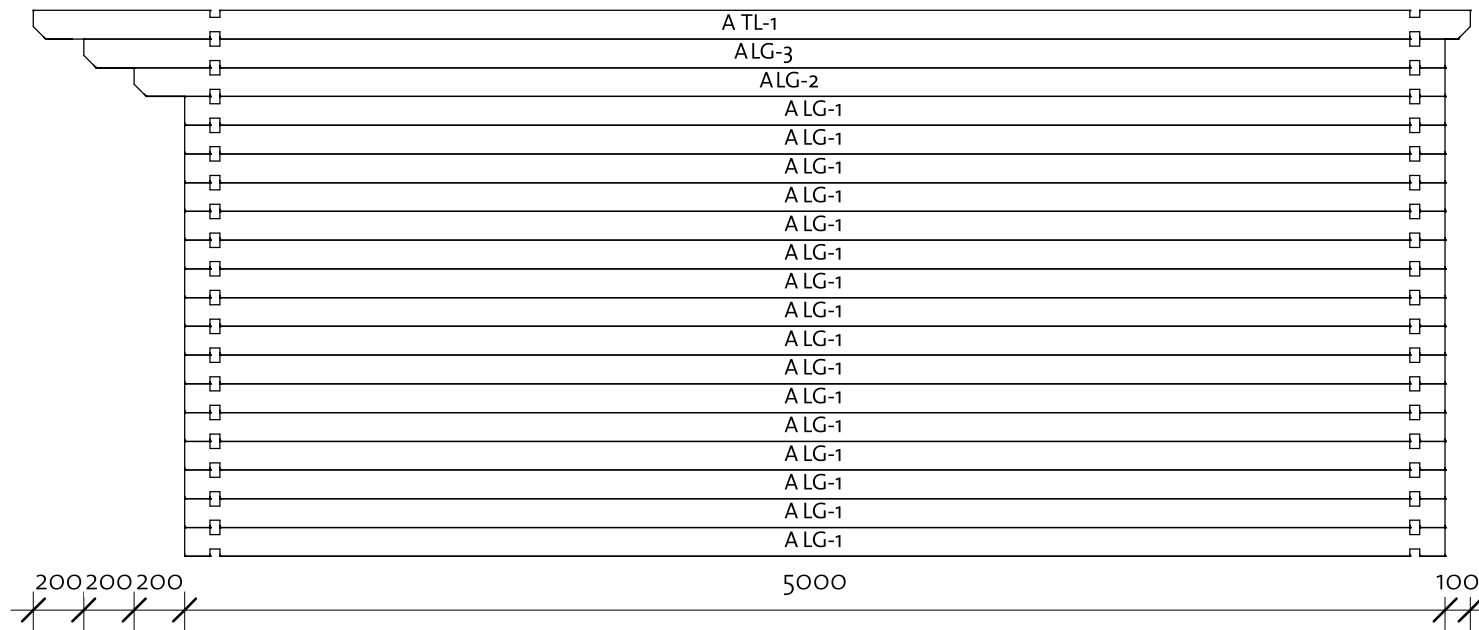

Log Profile Wall A	
Profile	Profile

40X114	
40X114	

Callsen 40 (646x480)

Wall B

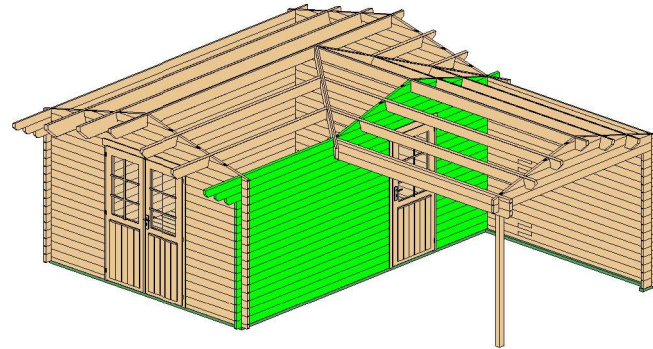

* Gable - delivered premounted

Wall B			
Mark	Profile	Count	Cut Length
BLG-1 *	40X57	1	385
BLG-2 *	40X114	1	1230
BLG-3 *	40X114	1	2075
BLG-4 *	40X114	1	2920
BLG-5 *	40X114	1	2930
BLG-6	40X114	1	5400
BLG-7	40X114	17	1175
BLG-8	40X114	1	3175
BLG-9	40X114	16	2975
BTL-1	40X114	1	2510
BTL-2	40X114	1	200

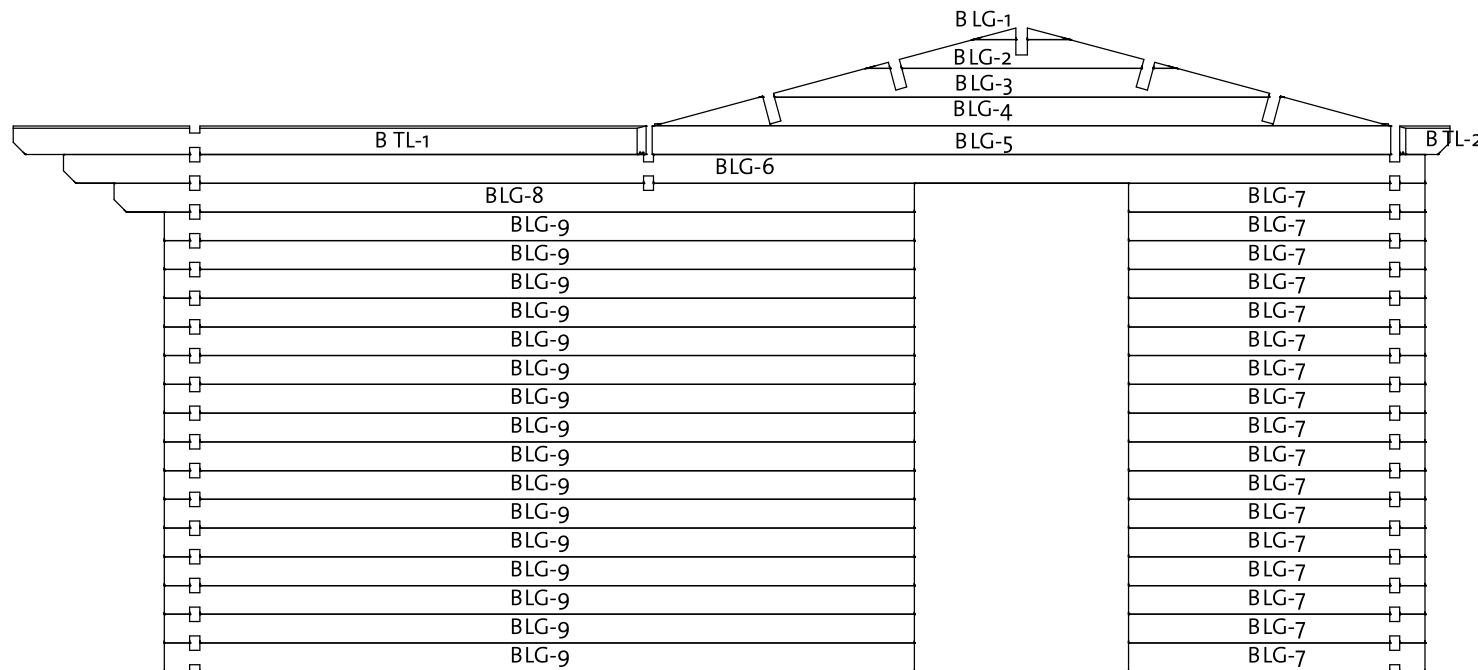

Log Profile Wall B

Profile | Profile

40X57



40X114

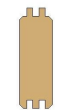

40X114

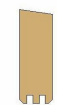

200 200 200
200302

2975

850

1175

Callsen 40 (646x480)

Roof 1

Columns			
Mark	Profile	Count	Length

CM1	Post 80x70	1	1938
-----	------------	---	------

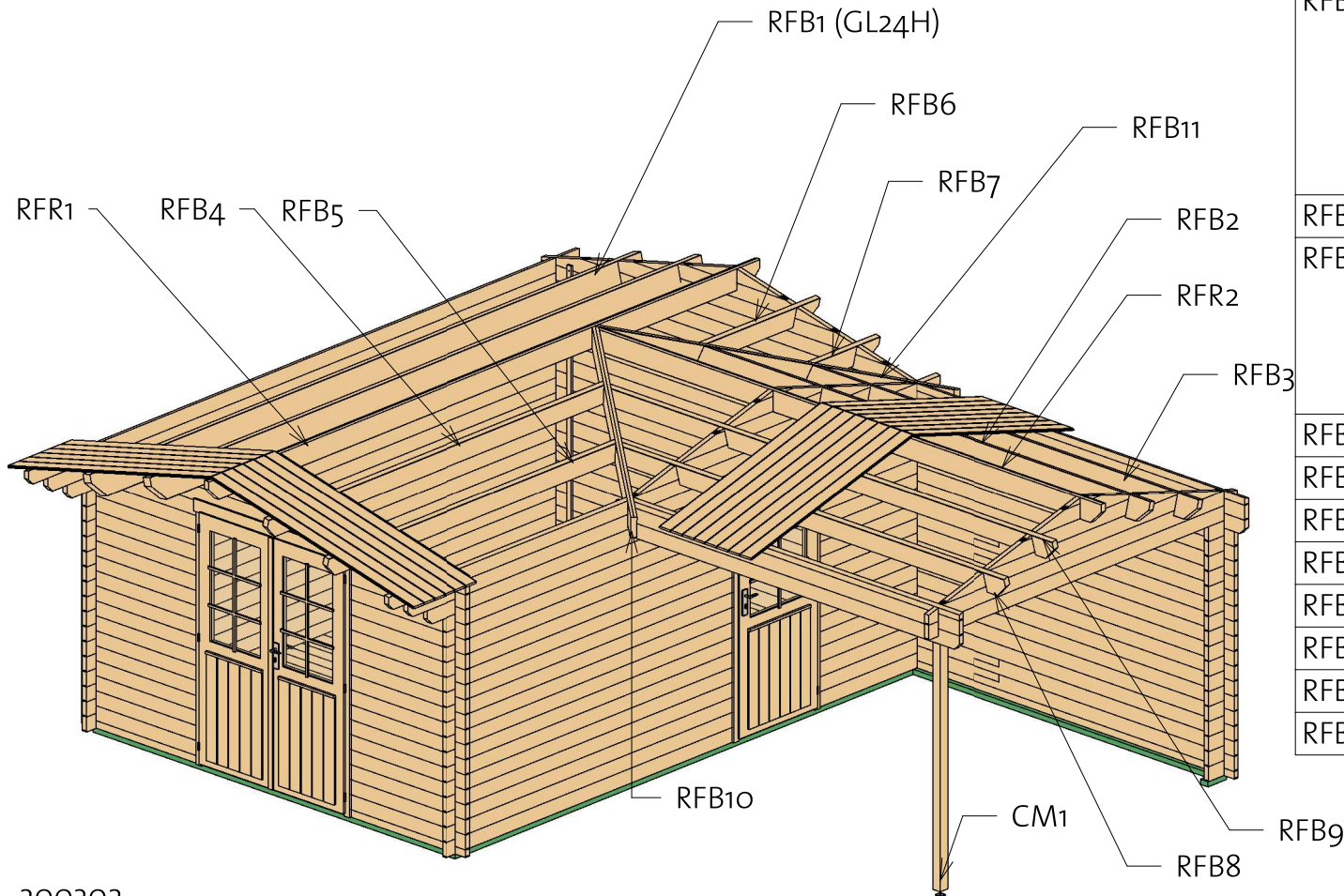

Roof				
Mark	Type	Profile	Count	Length

RFR2	Ridge 45x170		1	4853
RFR1	Ridge 45x170		1	5700
RFB11	Beam 45x170		1	2632
RFB10	Beam 45x170		1	2556
RFB9	Beam 45x170		1	4343
RFB8	Beam 45x170		1	3766
RFB7	Beam 45x170		1	744
RFB6	Beam 45x170		1	1243
RFB5	Beam 45x170		1	3044
RFB4	Beam 45x170		1	3543
RFB3	Beam 45x170		1	3766
RFB2	Beam 45x170		1	4343
RFB1	Beam 68x198		2	5700

Callsen 40 (646x480)

Roof 2

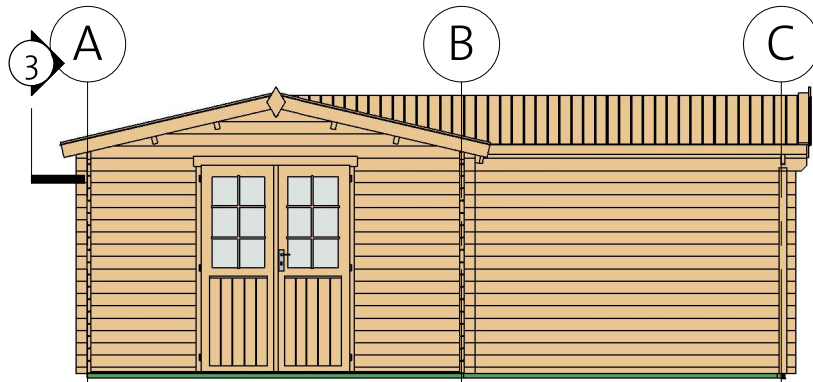
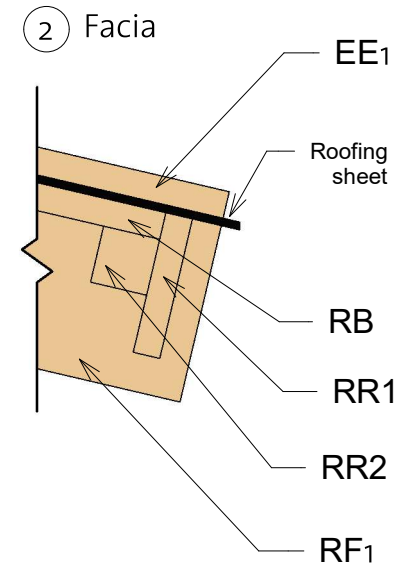
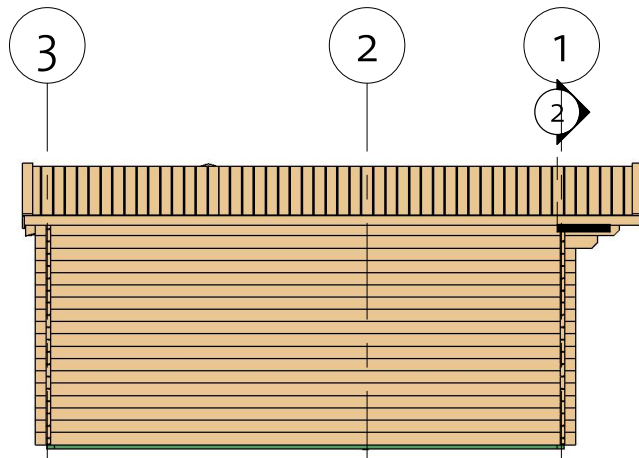



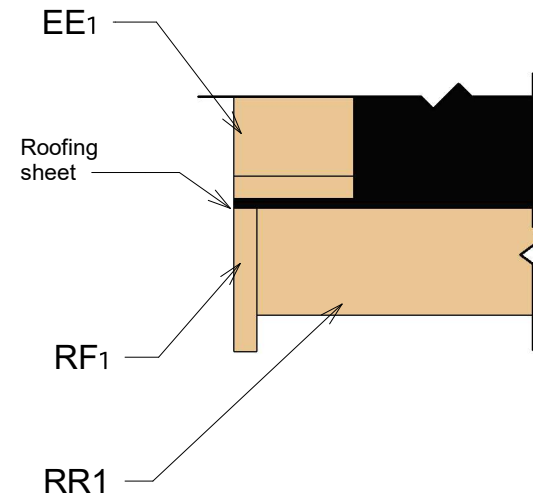







3 Roof Reinforcement



Callsen 40 (646x480)

Roof 3

Fascia Schedule				
Mark	Type	Profile	Count	Length
EE1	Eave Edging 18x95		4	2040
EE2	Eave Edging 18x95		2	1765
RF1	Roof Fascia 18x120		4	2040
RF2	Roof Fascia 18x120		2	1765
RR1	Roof reinforcement 18x95		1	5700
RR2	Roof reinforcement 18x95		1	2336

Fascia Schedule				
Mark	Type	Profile	Count	Length
RR3	Roof reinforcement 18x95		1	2964
RR4	Roof reinforcement 18x95		1	2942
RR5	Roof reinforcement 38x38		1	5700
RR6	Roof reinforcement 38x38		1	2336
RR7	Roof reinforcement 38x38		2	2964

Callsen 40 (646x480)

Roof 4

Roofboards				
Mark	Type	Profile	Count	Length

RB1	Roofboard 18x110		75	1998
RB2	Roofboard 18x110		58	1723
RB3	Roofboard 18x110		1	1728
RB4	Roofboard 18x110		1	1653
RB5	Roofboard 18x110		1	1554
RB6	Roofboard 18x110		1	1456
RB7	Roofboard 18x110		1	1357
RB8	Roofboard 18x110		1	1259
RB9	Roofboard 18x110		1	1160
RB10	Roofboard 18x110		1	1062
RB11	Roofboard 18x110		1	963
RB12	Roofboard 18x110		1	864
RB13	Roofboard 18x110		1	766
RB14	Roofboard 18x110		1	667
RB15	Roofboard 18x110		1	569
RB16	Roofboard 18x110		1	470
RB17	Roofboard 18x110		1	372
RB18	Roofboard 18x110		1	273
RB19	Roofboard 18x110		1	174
RB20	Roofboard 18x110		1	74
RB21	Roofboard 18x110		1	1728
RB22	Roofboard 18x110		1	1647
RB23	Roofboard 18x110		1	1548
RB24	Roofboard 18x110		1	1449
RB25	Roofboard 18x110		1	1351
RB26	Roofboard 18x110		1	1252
RB27	Roofboard 18x110		1	1154
RB28	Roofboard 18x110		1	1055
RB29	Roofboard 18x110		1	957
RB30	Roofboard 18x110		1	858
RB31	Roofboard 18x110		1	759
RB32	Roofboard 18x110		1	661
RB33	Roofboard 18x110		1	562
RB34	Roofboard 18x110		1	464
RB35	Roofboard 18x110		1	365
RB36	Roofboard 18x110		1	267
RB37	Roofboard 18x110		1	168
RB38	Roofboard 18x110		1	69
RB39	Roofboard 18x110		1	1987
RB40	Roofboard 18x110		1	1856
RB41	Roofboard 18x110		1	1726
RB42	Roofboard 18x110		1	1595
RB43	Roofboard 18x110		1	1464
RB44	Roofboard 18x110		1	1334
RB45	Roofboard 18x110		1	1203
RB46	Roofboard 18x110		1	1073
RB47	Roofboard 18x110		1	942
RB48	Roofboard 18x110		1	812
RB49	Roofboard 18x110		1	681
RB50	Roofboard 18x110		1	551
RB51	Roofboard 18x110		1	420
RB52	Roofboard 18x110		1	289

Roofboards				
Mark	Type	Profile	Count	Length

RB53	Roofboard 18x110		1	159
RB54	Roofboard 18x110		1	1998
RB55	Roofboard 18x110		1	1984
RB56	Roofboard 18x110		1	1853
RB57	Roofboard 18x110		1	1723
RB58	Roofboard 18x110		1	1592
RB59	Roofboard 18x110		1	1461
RB60	Roofboard 18x110		1	1331
RB61	Roofboard 18x110		1	1200
RB62	Roofboard 18x110		1	1070
RB63	Roofboard 18x110		1	939
RB64	Roofboard 18x110		1	809
RB65	Roofboard 18x110		1	678
RB66	Roofboard 18x110		1	548
RB67	Roofboard 18x110		1	417
RB68	Roofboard 18x110		1	286
RB69	Roofboard 18x110		1	156
RB70	Roofboard 18x45		1	1998

* Start RB mounting with Walleys

RB3

RB21

RB70

RB54

Callsen 40 (646x480)





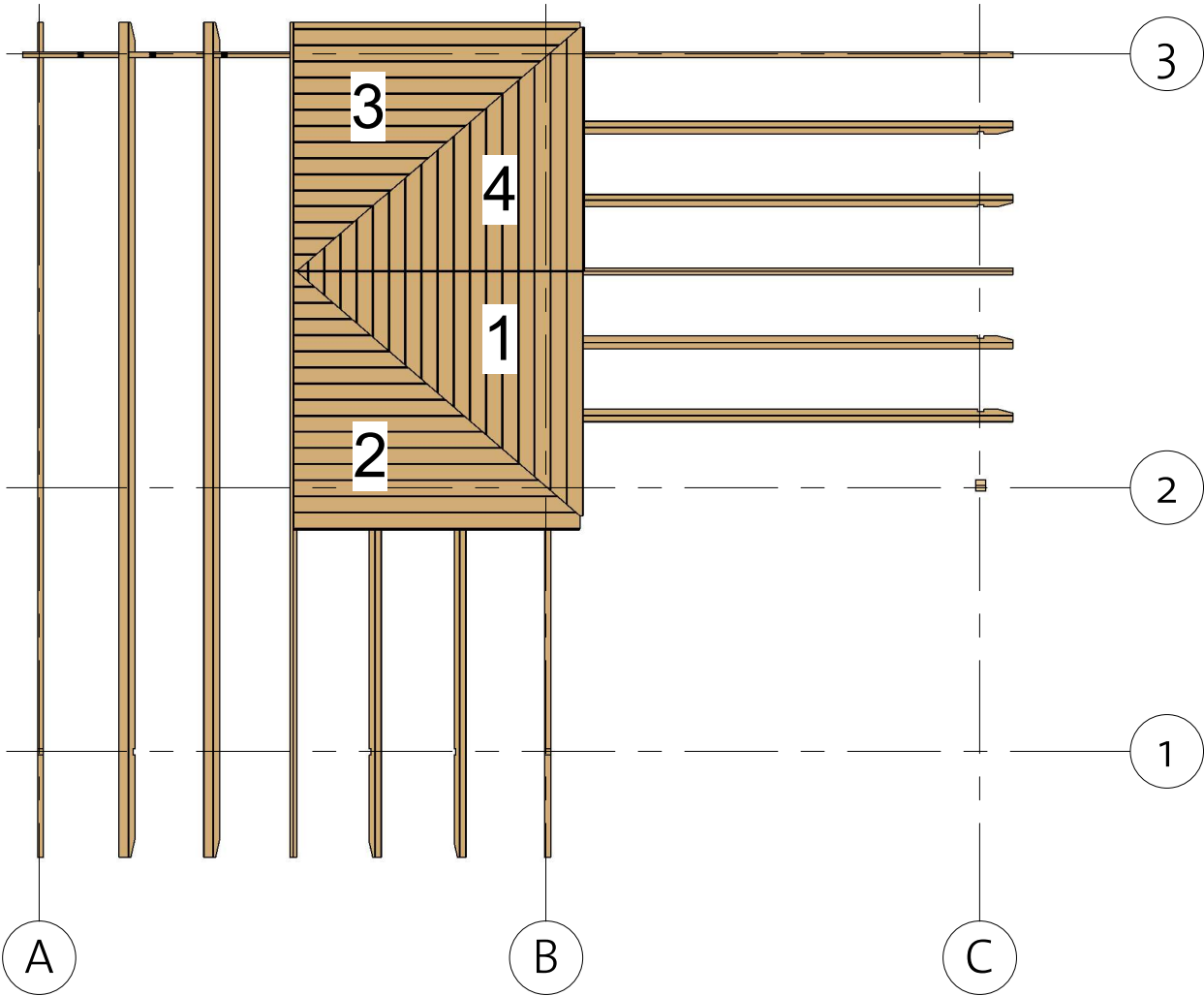

























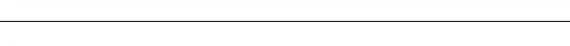

Roof 5

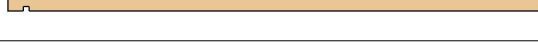
① Plan for mounting roofboards

































Callsen 40 (646x480)

List of all items 1

	RFB1	Beam 68x198			2	5700
	RFR1	Ridge 45x170			1	5700
A	TL-1	Log 40x114			1	5700
A	LG-3	Log 40x114			1	5400
B	LG-6	Log 40x114			1	5400
A	LG-2	Log 40x114			1	5200
A	LG-1	Log 40x114			16	5000
	RFR2	Ridge 45x170			1	4853
	IFB1	IFB 70x40			1	4720
	IFB2	IFB 70x40			6	4650
3	LG-1 o	Log 40x114			6	4400
	RFB2	Beam 45x170			1	4343
	RFB9	Beam 45x170			1	4343
	RFB3	Beam 45x170			1	3766
	RFB8	Beam 45x170			1	3766
1	LG-5	Log 40x114			1	3700
3	BL-2	HalfLog 40x57			1	3580
3	LG-5	Log 40x114			1	3580
3	LG-6	Log 40x114			11	3580
	RFB4	Beam 45x170			1	3543
	IFB3	IFB 70x40			1	3490
	IFB4	IFB 70x40			1	3420
	FB 191217	FB 18x110			44	3414

Callsen 40 (646x480)

List of all items 2

2	LG-1	Log 40X114			1	3300
2	LG-2	Log 40X114			1	3300
C	LG-6	Log 40X114			1	3200
3	LG-7	Log 40X114			1	3180
3	LG-8	Log 40X114			1	3180
B	LG-8	Log 40X114			1	3175
2	TL-1	Log 40X57			1	3166
3	TL-1	Log 40X57			1	3166
3	BL-1	HalfLog 40X57			1	3080
3	LG-9	Log 40X114			16	3080
	RFB5	Beam 45X170			1	3044
B	LG-9	Log 40X114			16	2975
	IFB5	IFB 70X40			1	2890
	RFB11	Beam 45X170			1	2632
	RFB10	Beam 45X170			1	2556
B	TL-1	Log 40X114			1	2510
	RFB6	Beam 45X170			1	1243
B	LG-7	Log 40X114			17	1175
1	BL-1	HalfLog 40X57			2	1130
1	LG-6	Log 40X114			34	1130
	RFB7	Beam 45X170			1	744
C	LG-7	Log 40X114			17	300

Callsen 40 (646x480)

List of all items 3

Roofboards				
Mark	Type	Profile	Count	Length
RB1	Roofboard 18x110		75	1998
RB2	Roofboard 18x110		58	1723
RB3	Roofboard 18x110		1	1728
RB4	Roofboard 18x110		1	1653
RB5	Roofboard 18x110		1	1554
RB6	Roofboard 18x110		1	1456
RB7	Roofboard 18x110		1	1357
RB8	Roofboard 18x110		1	1259
RB9	Roofboard 18x110		1	1160
RB10	Roofboard 18x110		1	1062
RB11	Roofboard 18x110		1	963
RB12	Roofboard 18x110		1	864
RB13	Roofboard 18x110		1	766
RB14	Roofboard 18x110		1	667
RB15	Roofboard 18x110		1	569
RB16	Roofboard 18x110		1	470
RB17	Roofboard 18x110		1	372
RB18	Roofboard 18x110		1	273
RB19	Roofboard 18x110		1	174
RB20	Roofboard 18x110		1	74
RB21	Roofboard 18x110		1	1728
RB22	Roofboard 18x110		1	1647
RB23	Roofboard 18x110		1	1548
RB24	Roofboard 18x110		1	1449
RB25	Roofboard 18x110		1	1351
RB26	Roofboard 18x110		1	1252
RB27	Roofboard 18x110		1	1154
RB28	Roofboard 18x110		1	1055
RB29	Roofboard 18x110		1	957
RB30	Roofboard 18x110		1	858
RB31	Roofboard 18x110		1	759
RB32	Roofboard 18x110		1	661
RB33	Roofboard 18x110		1	562
RB34	Roofboard 18x110		1	464
RB35	Roofboard 18x110		1	365
RB36	Roofboard 18x110		1	267
RB37	Roofboard 18x110		1	168
RB38	Roofboard 18x110		1	69
RB39	Roofboard 18x110		1	1987
RB40	Roofboard 18x110		1	1856
RB41	Roofboard 18x110		1	1726
RB42	Roofboard 18x110		1	1595
RB43	Roofboard 18x110		1	1464
RB44	Roofboard 18x110		1	1334
RB45	Roofboard 18x110		1	1203
RB46	Roofboard 18x110		1	1073
RB47	Roofboard 18x110		1	942
RB48	Roofboard 18x110		1	812
RB49	Roofboard 18x110		1	681
RB50	Roofboard 18x110		1	551
RB51	Roofboard 18x110		1	420
RB52	Roofboard 18x110		1	289

Roofboards				
Mark	Type	Profile	Count	Length
RB53	Roofboard 18x110		1	159
RB54	Roofboard 18x110		1	1998
RB55	Roofboard 18x110		1	1984
RB56	Roofboard 18x110		1	1853
RB57	Roofboard 18x110		1	1723
RB58	Roofboard 18x110		1	1592
RB59	Roofboard 18x110		1	1461
RB60	Roofboard 18x110		1	1331
RB61	Roofboard 18x110		1	1200
RB62	Roofboard 18x110		1	1070
RB63	Roofboard 18x110		1	939
RB64	Roofboard 18x110		1	809
RB65	Roofboard 18x110		1	678
RB66	Roofboard 18x110		1	548
RB67	Roofboard 18x110		1	417
RB68	Roofboard 18x110		1	286
RB69	Roofboard 18x110		1	156

* Start RB mounting with Walleys

RB3
RB21
RB39
RB54

① RB 3-20

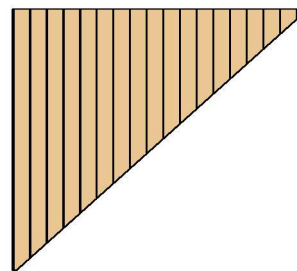

② RB 21-38

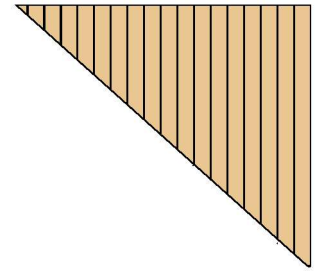

③ RB 39-53

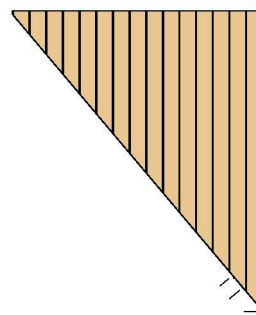

④ RB 54-69

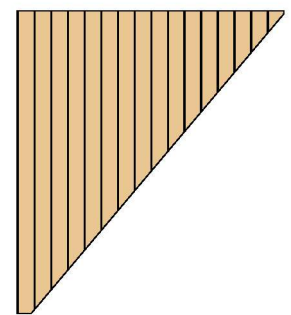

Callsen 40 (646x480)

List of all items 4

① Gable 1

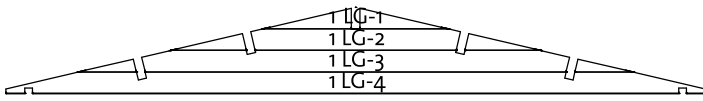

② Gable 3

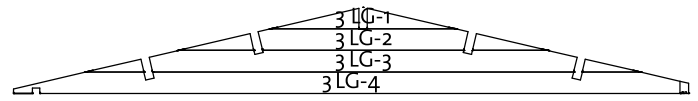



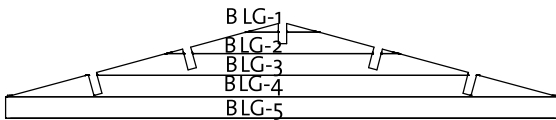

③ Gable B

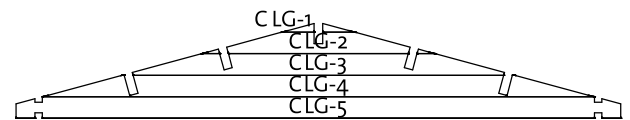











④ Gable C



IFB6	IFB 70x40			1	195
------	--------------	---	---	---	-----

BB1	BB 20x40			2	4800
BB2	BB 20x40			2	3500

RR1	Roof reinforcement 18x95			1	5700
RR5	Roof reinforcement 38x38			1	5700
RR3	Roof reinforcement 18x95			1	2964
RR7	Roof reinforcement 38x38			2	2964
RR4	Roof reinforcement 18x95			1	2942
RR2	Roof reinforcement 18x95			1	2336
RR6	Roof reinforcement 38x38			1	2336
EE1	Eave Edging 18x95			4	2040
RF1	Roof Fascia 18x120			4	2040
EE2	Eave Edging 18x95			2	1765
RF2	Roof Fascia 18x120			2	1765

Callsen 40 (646x480)

List of all items 5

CM1	Post 80x70		1	1938
-----	------------	---	---	------

Windboard 18x40		5	2200
-----------------	---	---	------







Romb	3	
------	---	---

Adjustable post foot	1	
----------------------	---	---

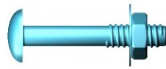
CDD1R	Classic double door 1 right	1425	1955	1
CD1R	Classic door 1 right	840	1890	1



DCB6	Door Crossbar 6	--	--	3
------	-----------------	----	----	---

Hitblock	300-400 mm		
Bolts	M8x70		15
Screws	5,0 x 70		25
Nails	1,4 x 40		44
Dowels	16,0 x 150		48
Screws	6,0 x 140		128
Screws	4,0 x 40		210
Screws	4,0 x 50		1130