

Assembly, installation and maintenance manual

Montage-, Aufbau- und Wartungsanleitung • Assemblage, manuel de montage et d'entretien • Montaje, instalación, y mantenimiento • Manuale di montaggio, installazione e manutenzione • Monterings- og vedlikeholdsmanual • Monterings-, installations- och underhållsmanual • Kokoamis-, asennus- ja huolto-ohje • Vejledning for montering og vedligehold • Handleiding voor montage, installatie en onderhoud • Manual de montagem, instalação e manutenção • Návod k montáži, instalaci a údržbě • Instrukcja montażu, instalacji i konserwacji • Surinkimo, montavimo ir priežiūros vadovas • Montāžas, uzstādīšanas un apkopes rokasgrāmata • Руководство по сборке и обслуживанию • Montaaži-, paigaldus- ja säilitamise juhend







Element house **EL18-4533-3**





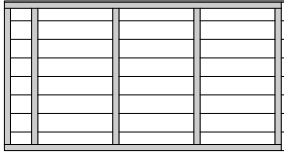

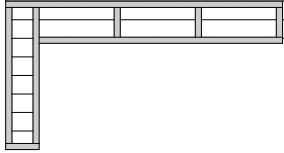
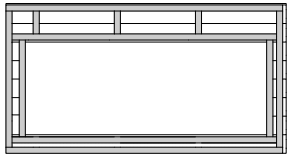
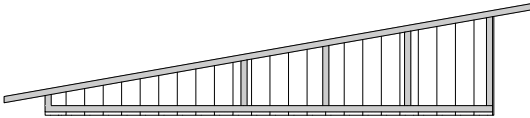
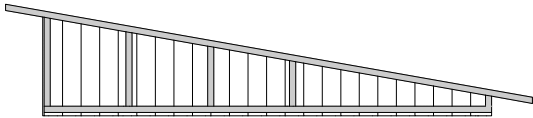
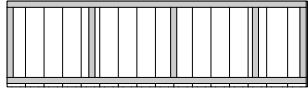

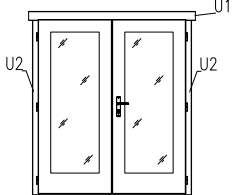
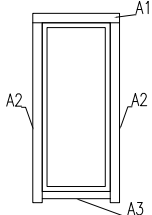

















Treatment options, Item code •

NO 109000

Behandlungsoptionen, Artikel-Code • Traitement options, code de l'article • Tratamiento opciones, código del artículo • Opzioni di trattamento, codice articolo • Behandlingsalternativer, artikkelnummer • Behandlingsalternativ, varukod • Käsittelevaihtoehdot, yksikön koodi • Behandlingsmuligheder, artikel nummer • Behandlingsopties, artikelnummer • Opções de tratamento, código do artigo • Povrchové úpravy, kód položky • Możliwości leczenia, kod produktu • Apdorojimo variantai, prekės kodas • Apstrādes iespējas, artikula kods • Варианты обработки, код изделия • Tõõtlusvõimalused, tootekood

<p>Factory inspection by • Werkskontrolle durch • Contrôle à partir de l'usine par • Inspector de fábrica • Collaudato da • Fabrikkkontroll utført av • Fabriksbesiktigat av • Tehtaan tarkastaja • Fabriks Kontrol udført af • Fabrikscontrole door • Inspeção de fábrica, por: • Zkontrolováno ve výrobním závodě • Kontrola fabryczna do • Apžiūra gamykloje atliko • Rūpnīcas pārbaudi veicis • Заводской контроль • Tehase kontroll teostatud:</p> <p>.....</p>	<p>Date • Datum • Date • Fecha • Data • Dato • Datum • Päiväys • Dato • Datum • Data • Datum • Data • Datums • Data • Дата • Kuupäev:</p> <hr/> <p>Pack number • Pack Nr. • Packet n° • Paquete N° • Pacco N. • Serienr • Produktionsnummer • Pakettinro • Pakke nr. • Pak nr. • Número de embalagem • Číslo balení • Numer opakowania • Pakuotės numeris • Iepakojuma numurs • Упаковочный номер • Pakinumber:</p>
---	---

EL1		2055 x 1097 x 88	10
EL2		2055 x 1097 x 88	1
EL3		2055 x 1097 x 88	1
EL5		2055 x 1097 x 88	2
EL6		3849 x 751 x 88	1
EL7		3849 x 751 x 88	1
EL8		2202 x 567 x 88	1
EL9		2192 x 567 x 88	1
TU105-2P	 <p> U1 - 19x70x1750 2 pcs U2 - 19x70x1870 4 pcs </p>	1600 x 1868 x 105	1
A105-4P	 <p> A1 - 19x70x830 2 pcs A2 - 19x70x1820 4 pcs A3 - 19x70x630 2 pcs </p>	660 x 1740 x 105	2

1	 Impregnated	45 x 145 x 4488	2
2	 Impregnated	45 x 145 x 3171	9
3		19 x 89 x 4488	37
4		34 x 70 x 4384	1
5		44 x 140 x 3910	7
6		10 x 165 x 576	12
7		10 x 165 x 450	4
8		16 x 120 x 2514	6
9		16 x 95 x 2514	2
10		16 x 45 x 2514	2
11		16 x 120 x 3957	4
12		16 x 95 x 3957	2
13		32 x 40 x 3890	2
14		19 x 89 x 4990	45
15		18 x 135 x 2055	4
16		18 x 135 x 545	2
F1		90 x 90 x 65	14
F2		Ø 6 x 120	36
F3		Ø 4.5 x 70	170
F4		Ø 4 x 50	330
F5		Ø 4 x 40	180
F6		Ø 3 x 70	700
F7		QULIUKAPal QULSI30x35	1 set
F8		QVentRest100x150Zn	2
F9		Ø 2.5 x 16	10
F10			1

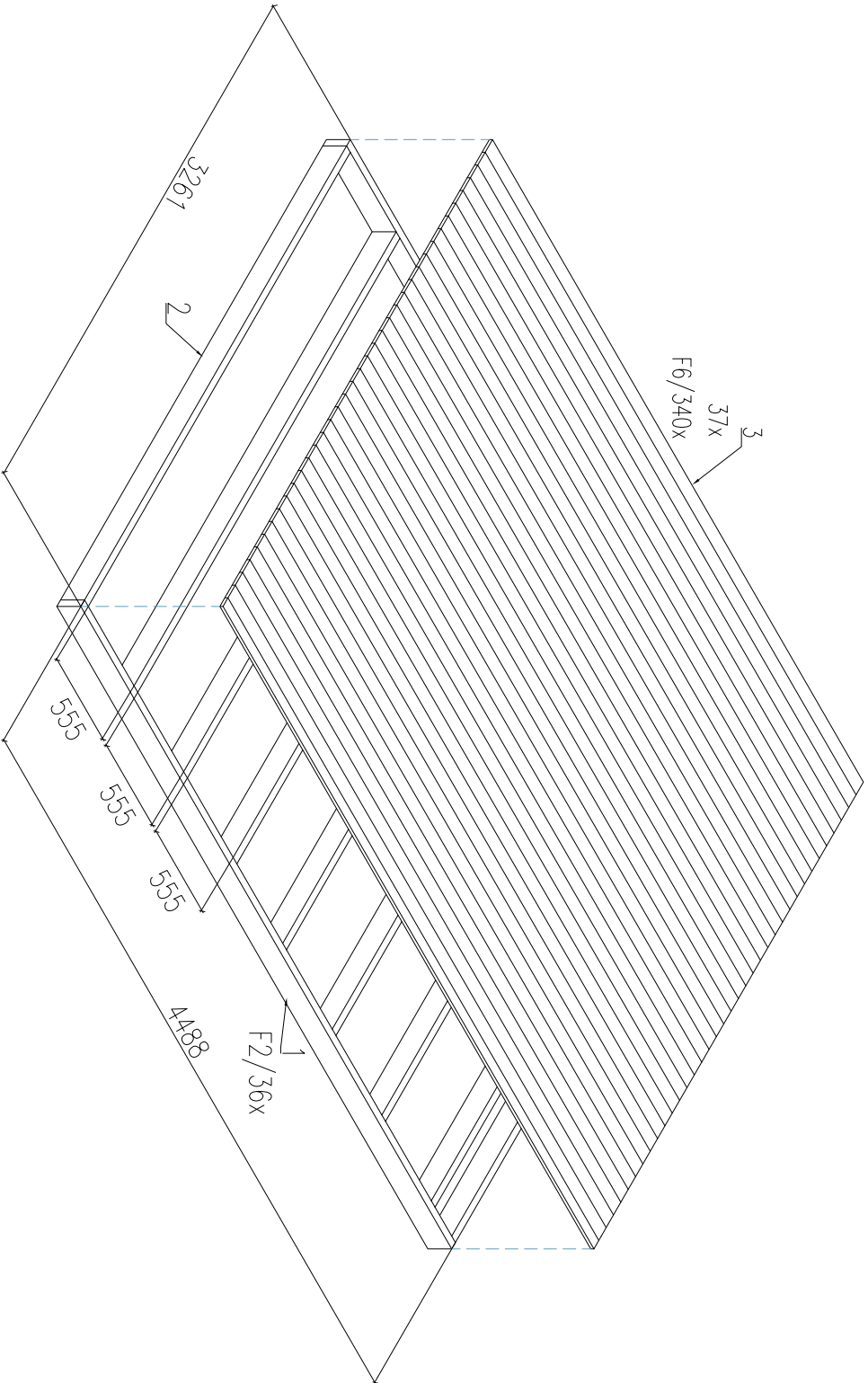

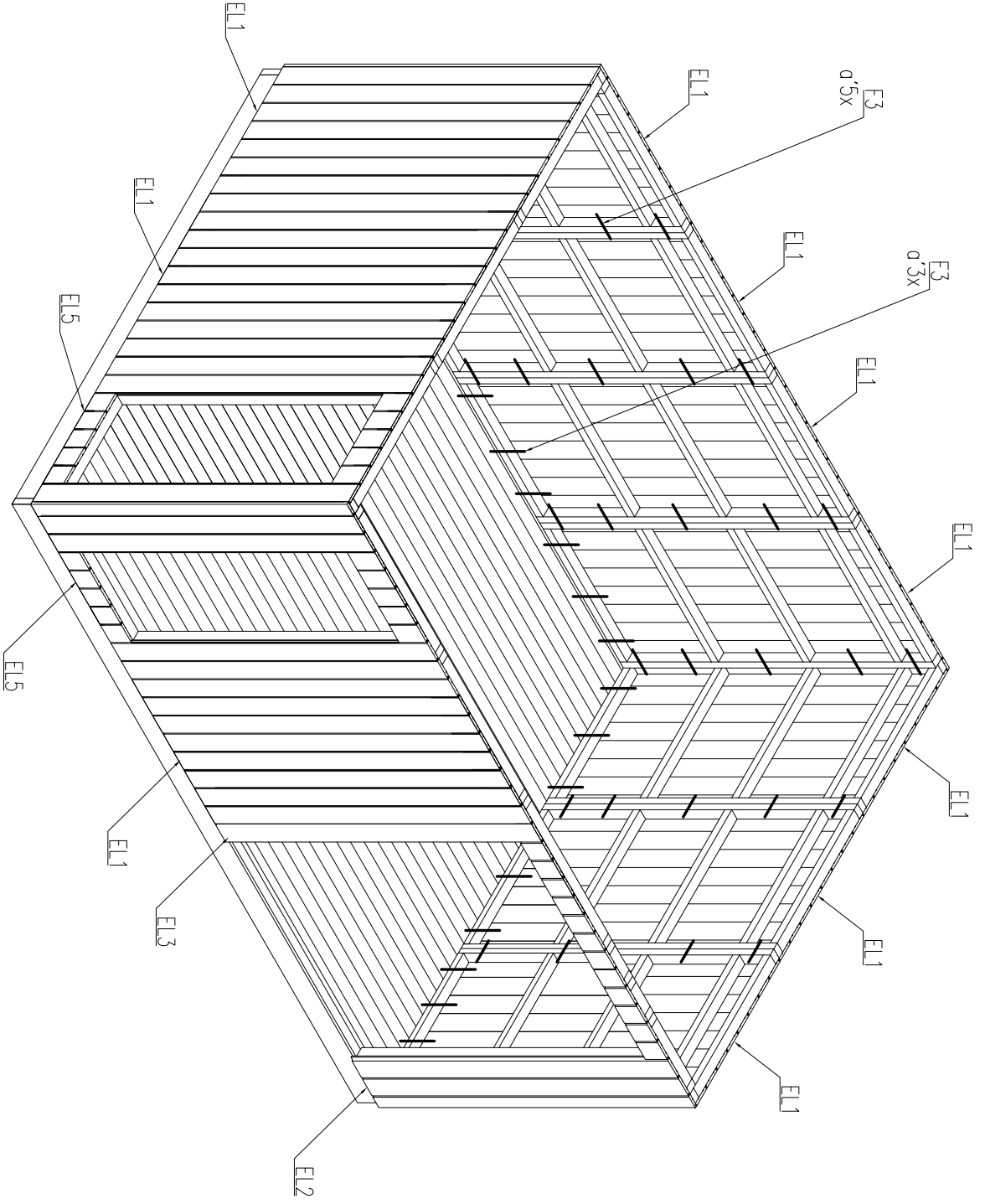

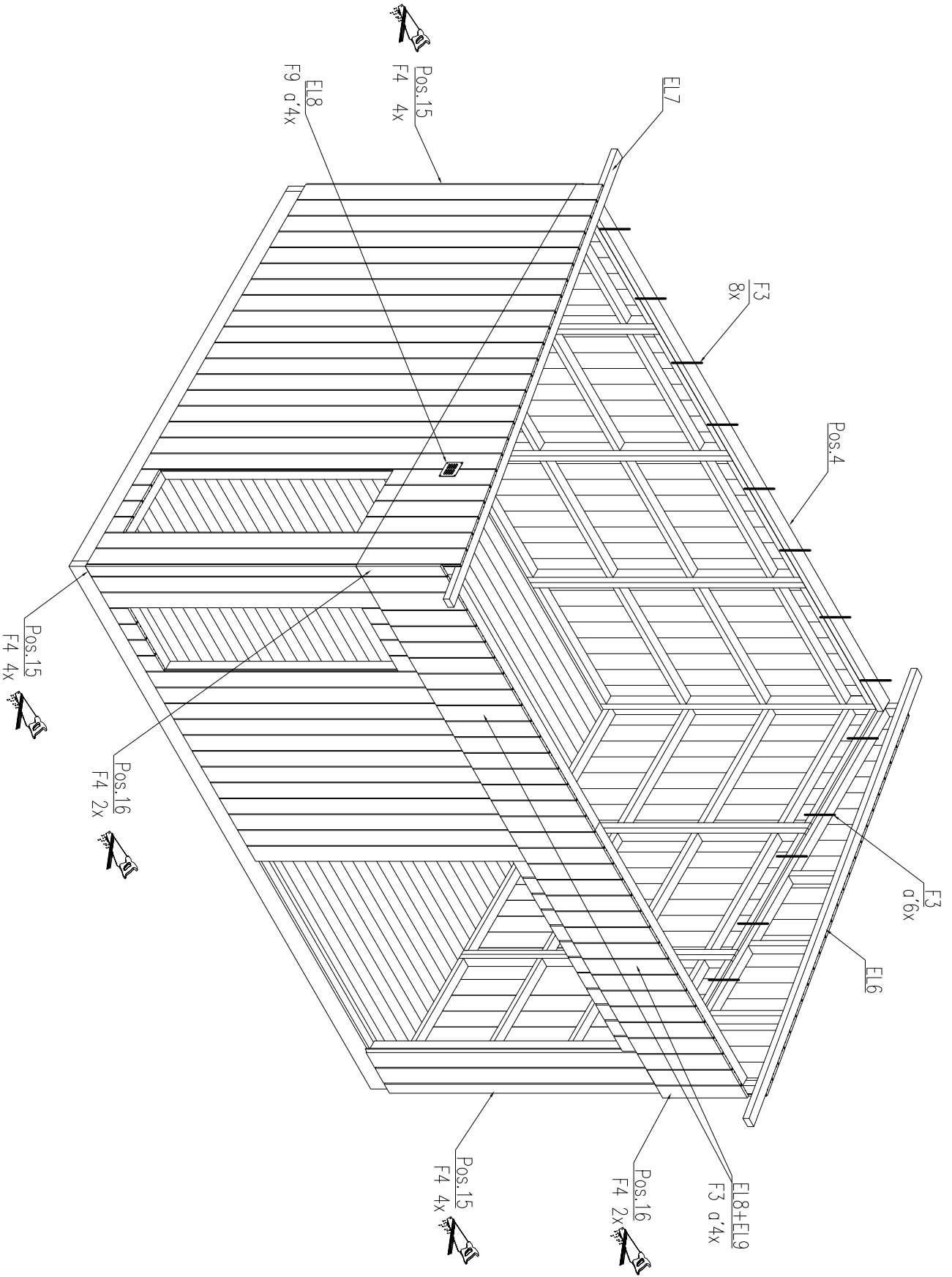

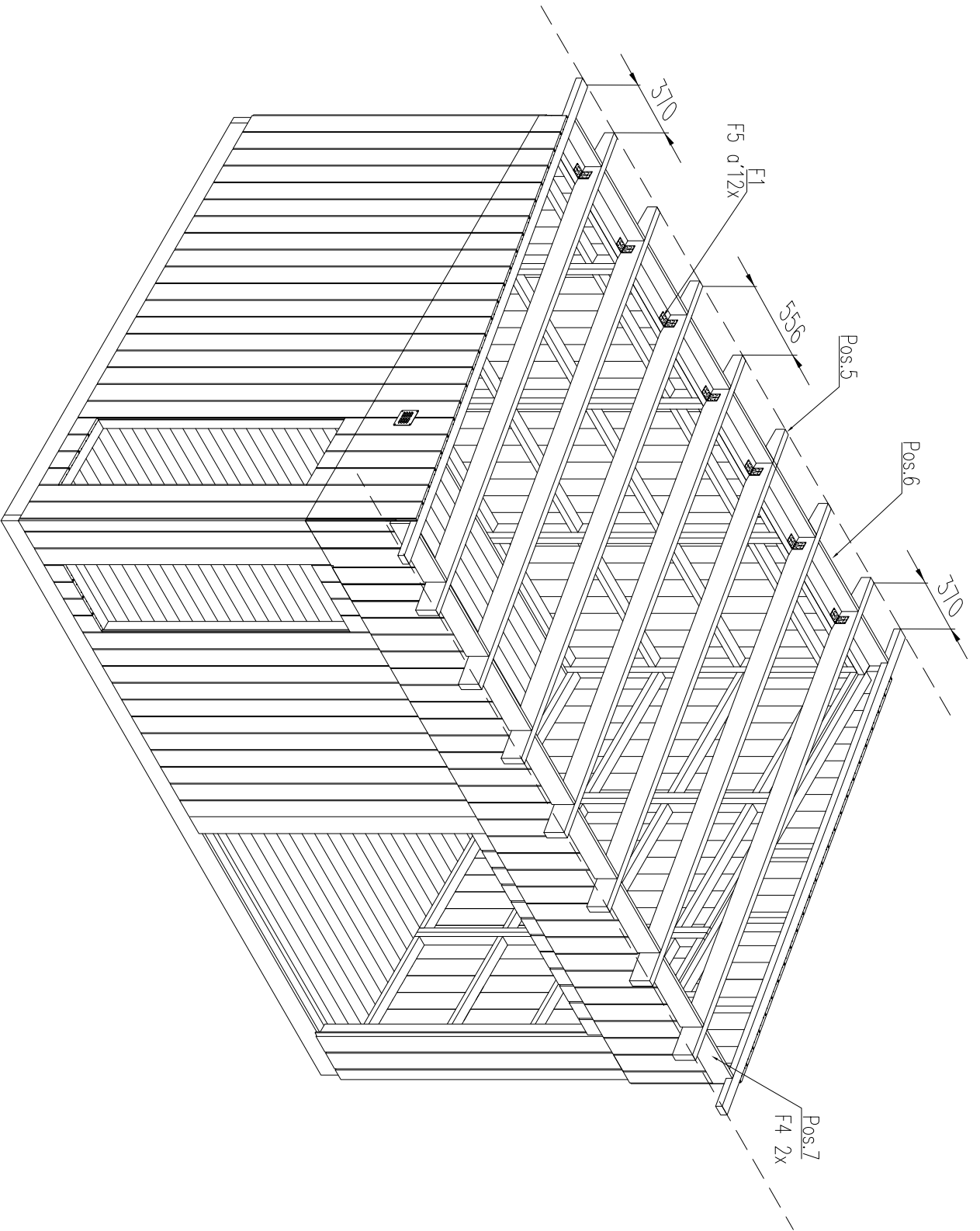

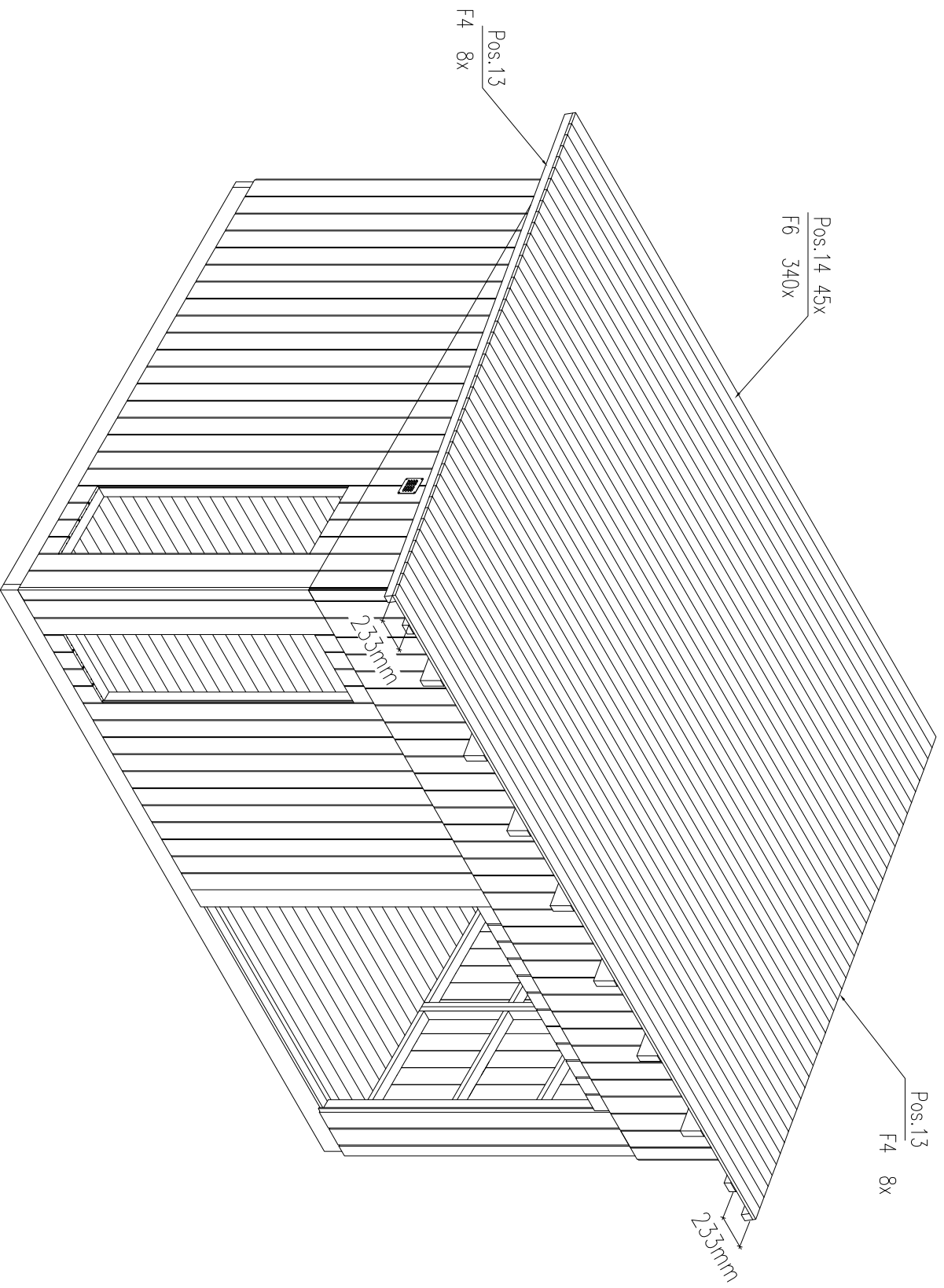

6

