

Techn. Data / Daten: Sauerland D o.Fb

Log length (W x D) / Bohlenaußenmaß (B x T): 470 x 470 cm

Wall size(outside) / Wandaußenmaß: 450 x 450 cm

Log thickness / Bohlenstärke: 70 mm

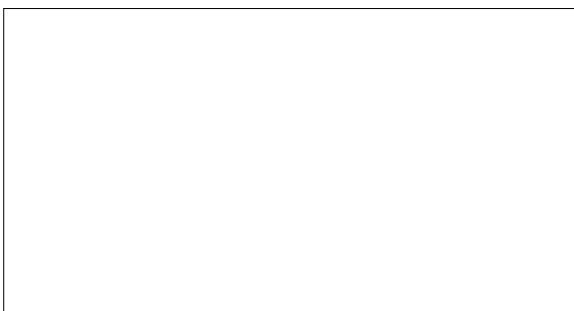
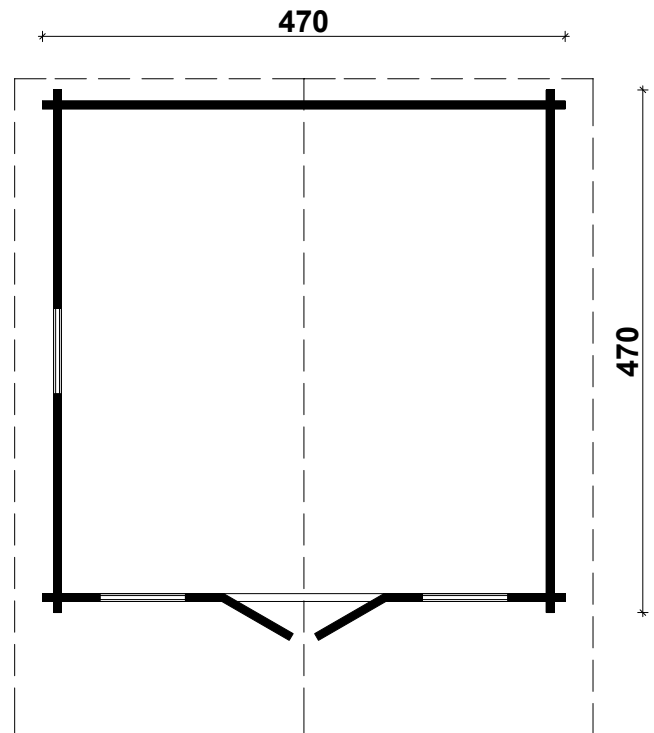
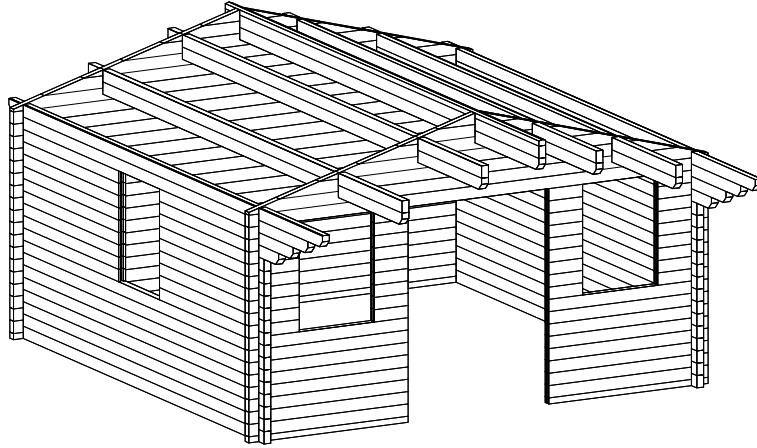

Note: All dimensions are approximate ! / Achtung : Alle angegebenen Maße sind ca. - Maße !

Sauerland D 70 mm / 470 x 470 cm - Foundation / Fundament o.Fb.

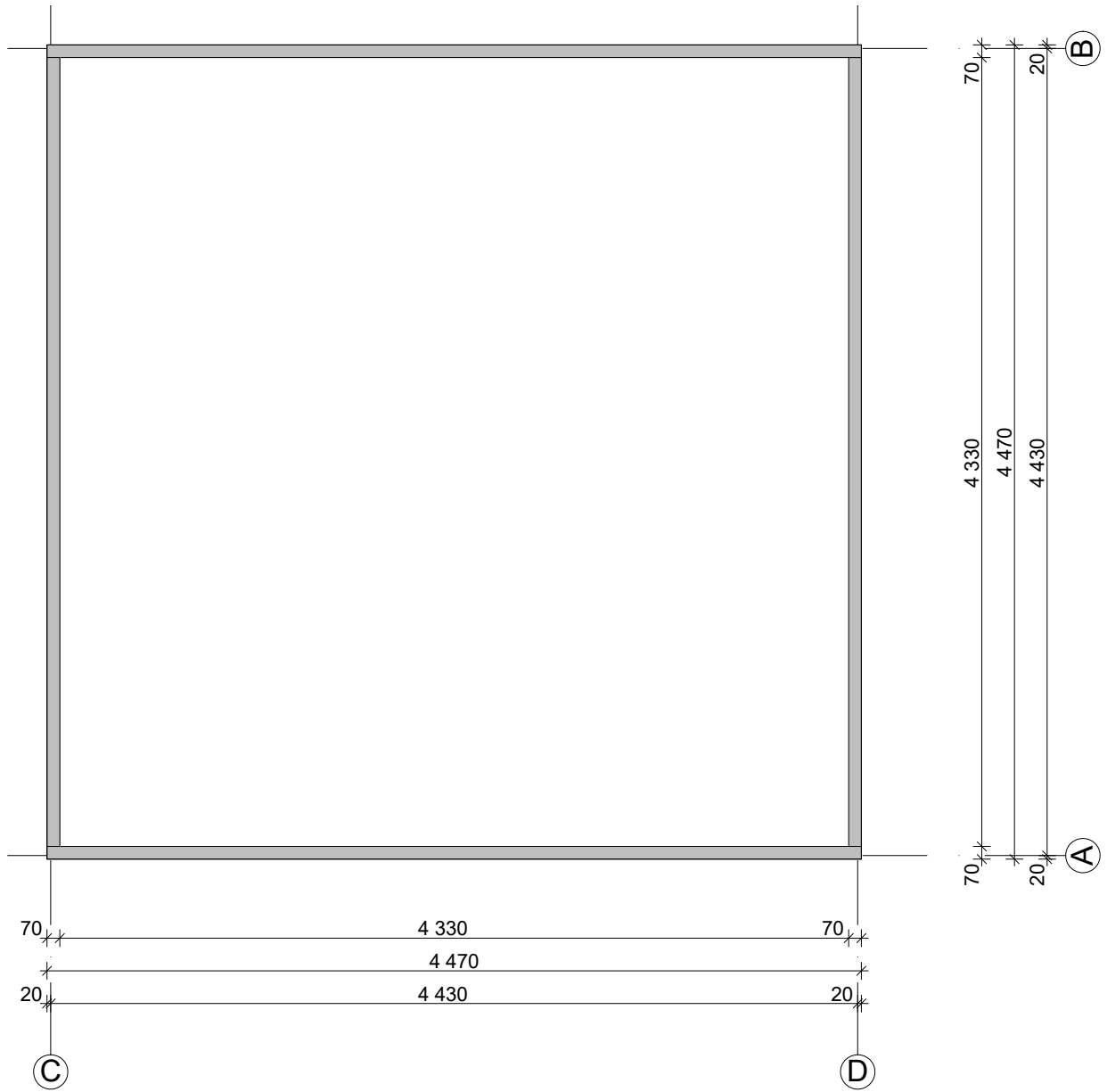

Sauerland D 70 mm / 470 x 470 cm - Groundplan / Wandplan o.Fb.

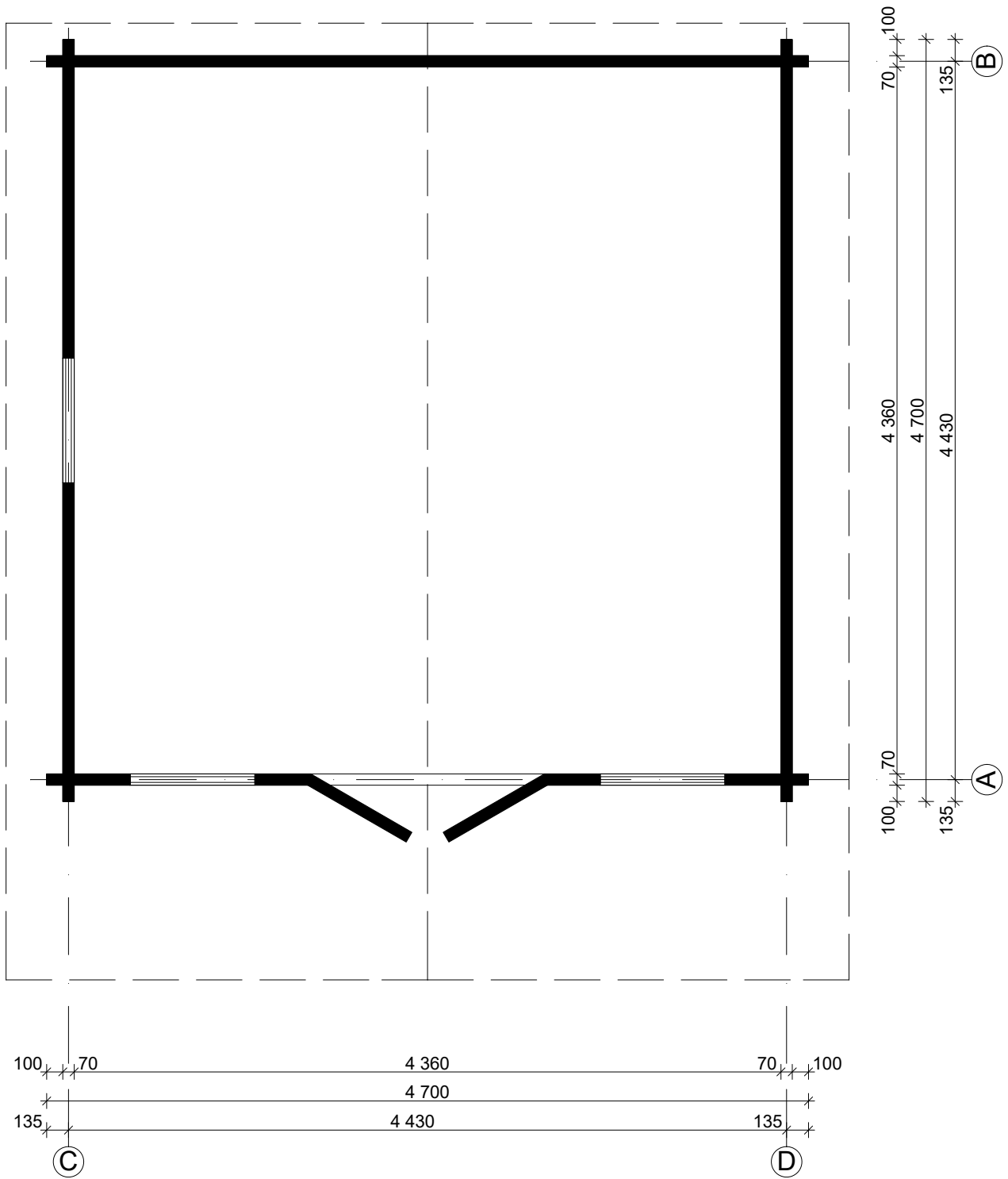

Sauerland D 70 mm / 470 x 470 cm o.Fb.

A

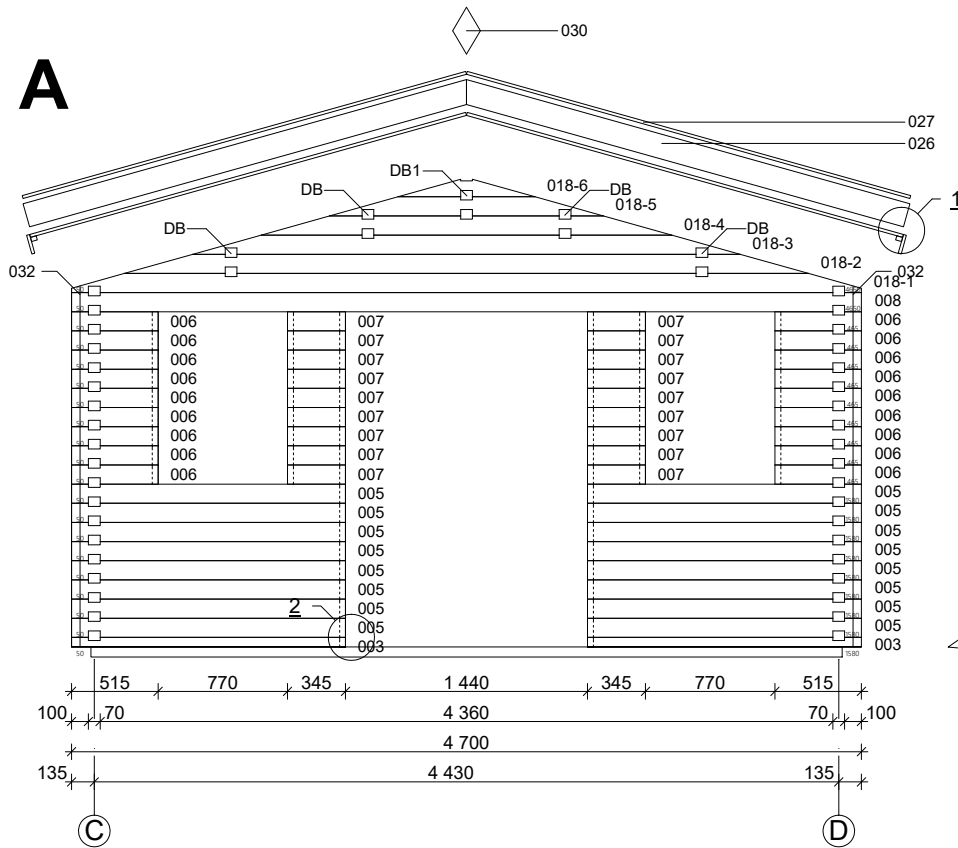

1

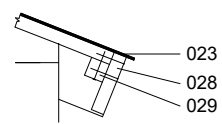

2

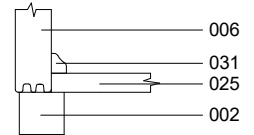
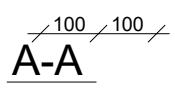
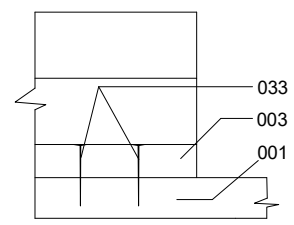

B

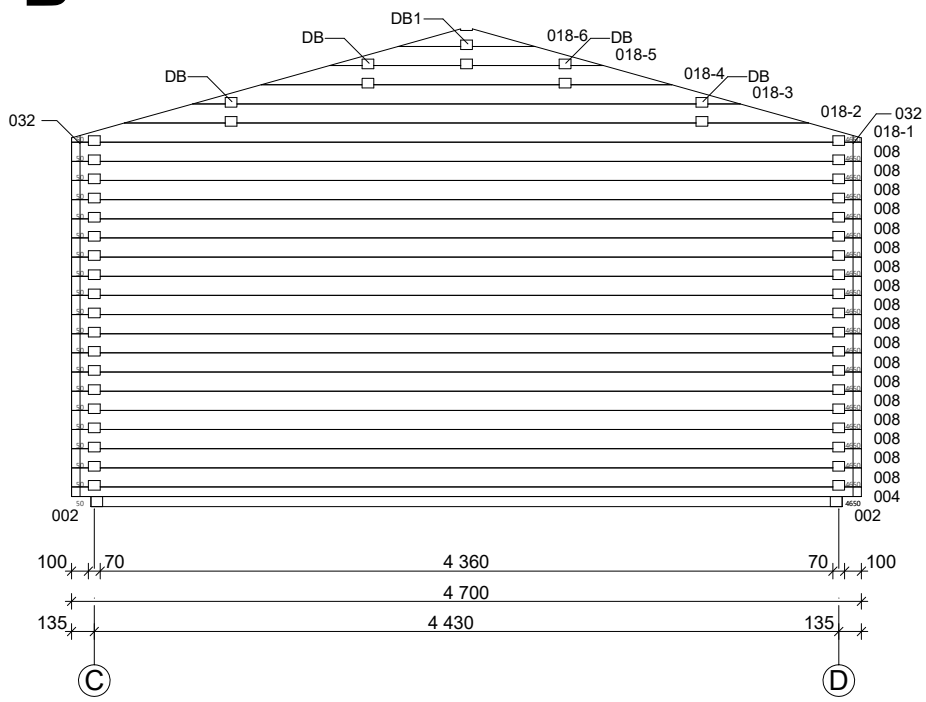

B-B

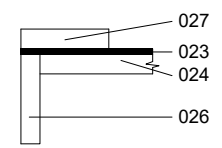

Sauerland D 70 mm / 470 x 470 cm o.Fb.

C

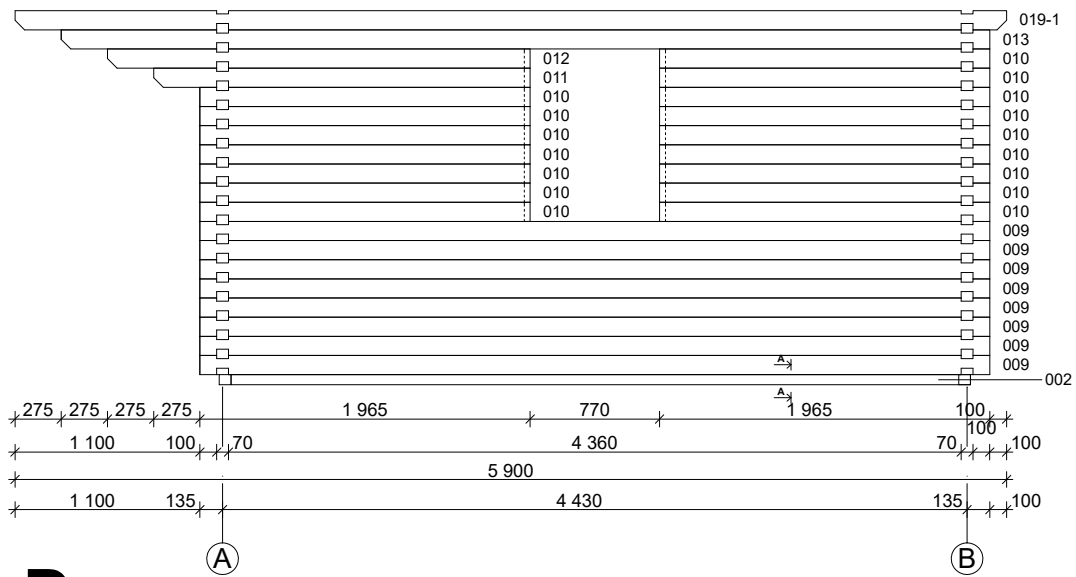

D

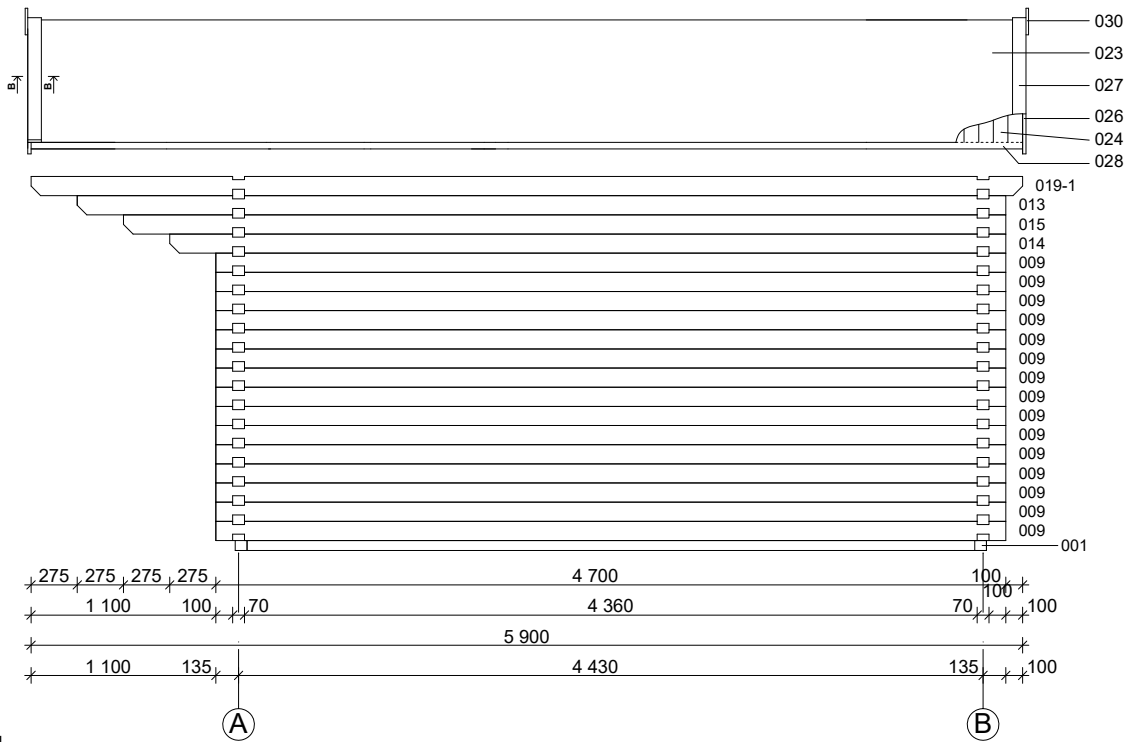



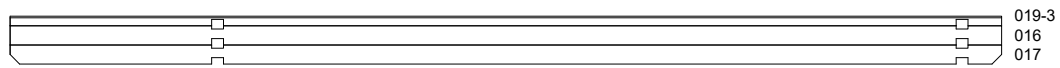



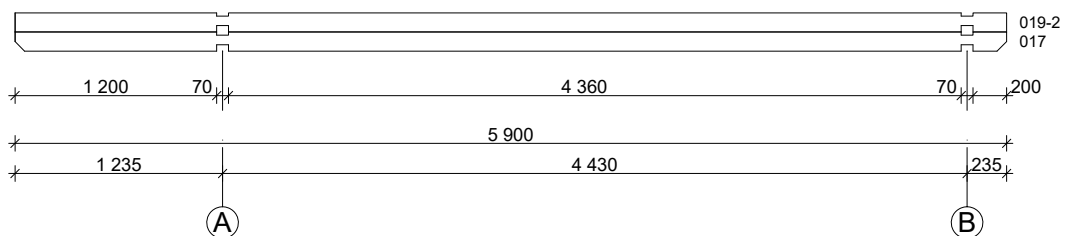







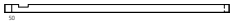

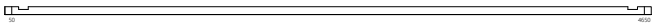



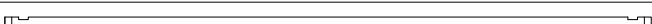
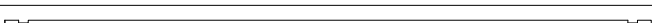
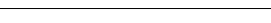
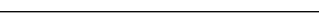





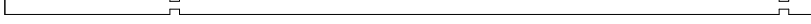
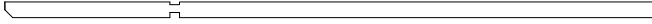
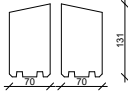

DB1



DB



Teileliste Sauerland D 70 mm / 470 x 470 cm o.Fb.

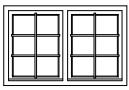
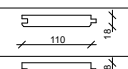
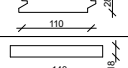
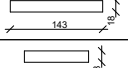
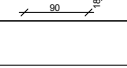

Nr.		 mm	 mm	 x	
001	Foundation joist / Fundament		4470	2	
002			4330	2	
003			1630	2	
004			4700	1	
005			1630	16	
006			515	18	
007			345	18	
008			4700	19	
009			4700	23	
010			1965	16	
011			2240	1	
012			5215	1	
013			5525	2	
014			4975	1	
015			5250	1	
016			5900	1	
017			5900	5	
018-1				4700	2
018-2				4071	2
018-3				3257	2
018-4				2443	2
018-5		1629		2	
018-6		814		2	
019-1			5900	2(1+1)	
019-2			5900	4(2+2)	
019-3			5900	1	
020	Double door / Doppeltür 1425 x 1955 mm / 70 mm DG/ISO - R			1	
021	Window / Einzelfenster 765 x 990 mm - 70 mm DG/ISO			3	
022			--	--	
023	Roofingfelt / Dachpappe		--	--	
024	Roof board / Dachbretter		2695	108+2	
025	Floor board / Fußbodenbretter		--	--	
026	Fascia board / Giebelblende		2740	4	
027	Gable edge board / Giebelabschlussbrett		2740	4	

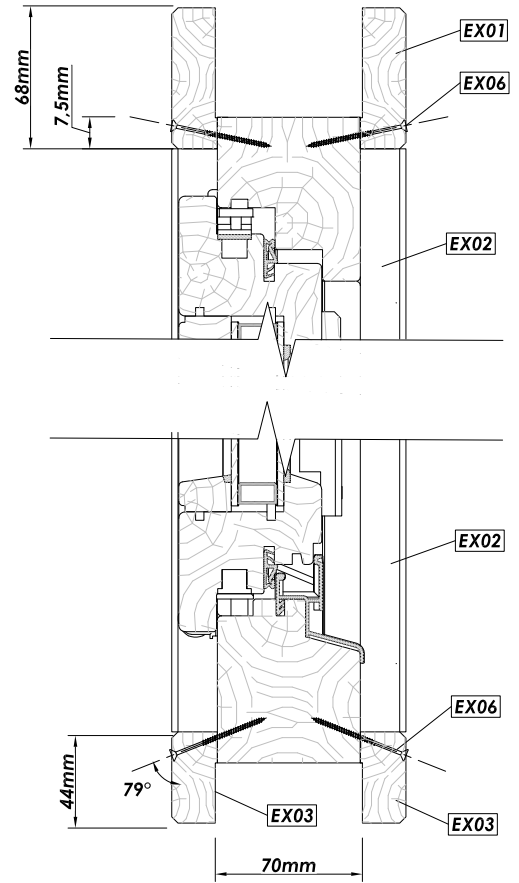
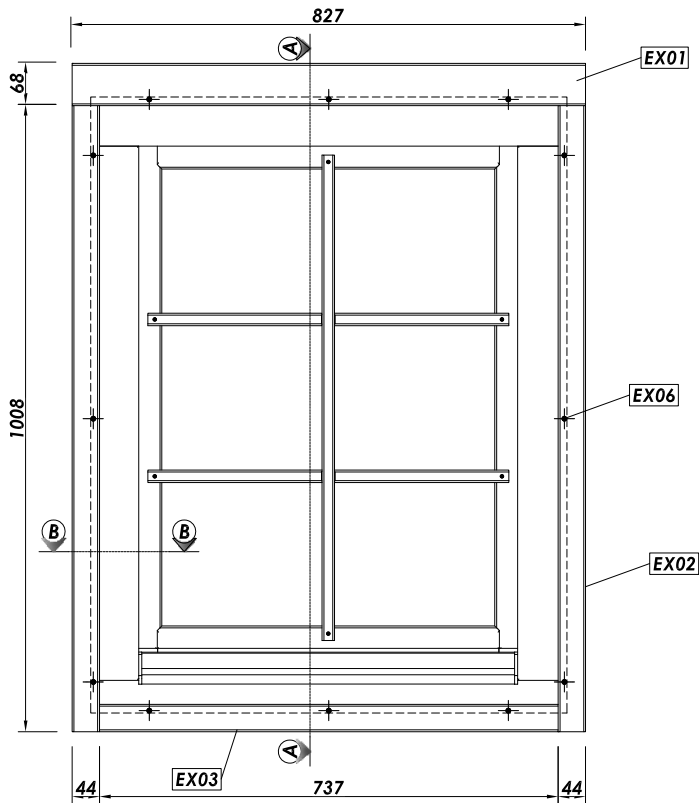
A - A

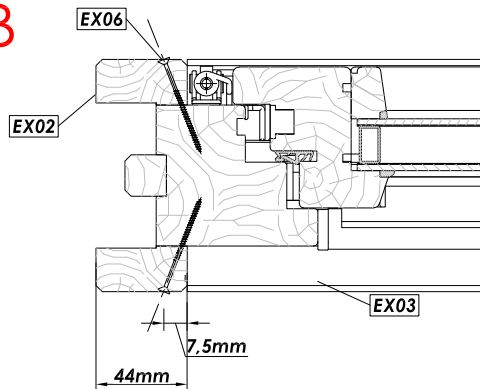

B - B



Premium Window 70mm / 765 x 990				
Nr.	Description	Profile mm	Length mm	Quantity
EX01	Exterior- and interior trim	 22x68	827	2
EX02	Exterior- and interior trim	 22x44	1008	4
EX03			737	2
EX04			--	--
EX05			--	--
EX06	Screws 3,5 x 50			

Double Door Frame 58/70mm

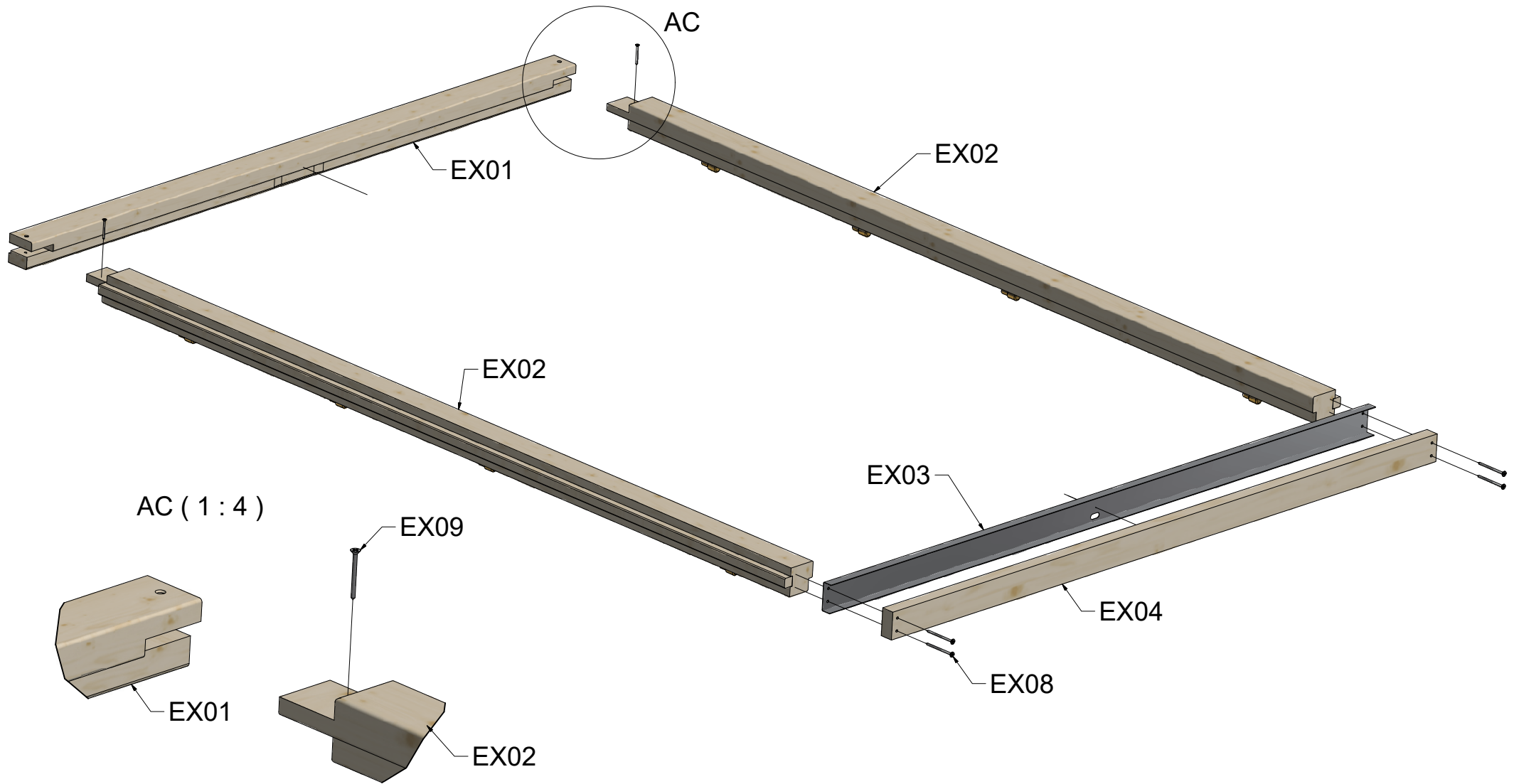

Double Door Frame 58/70mm

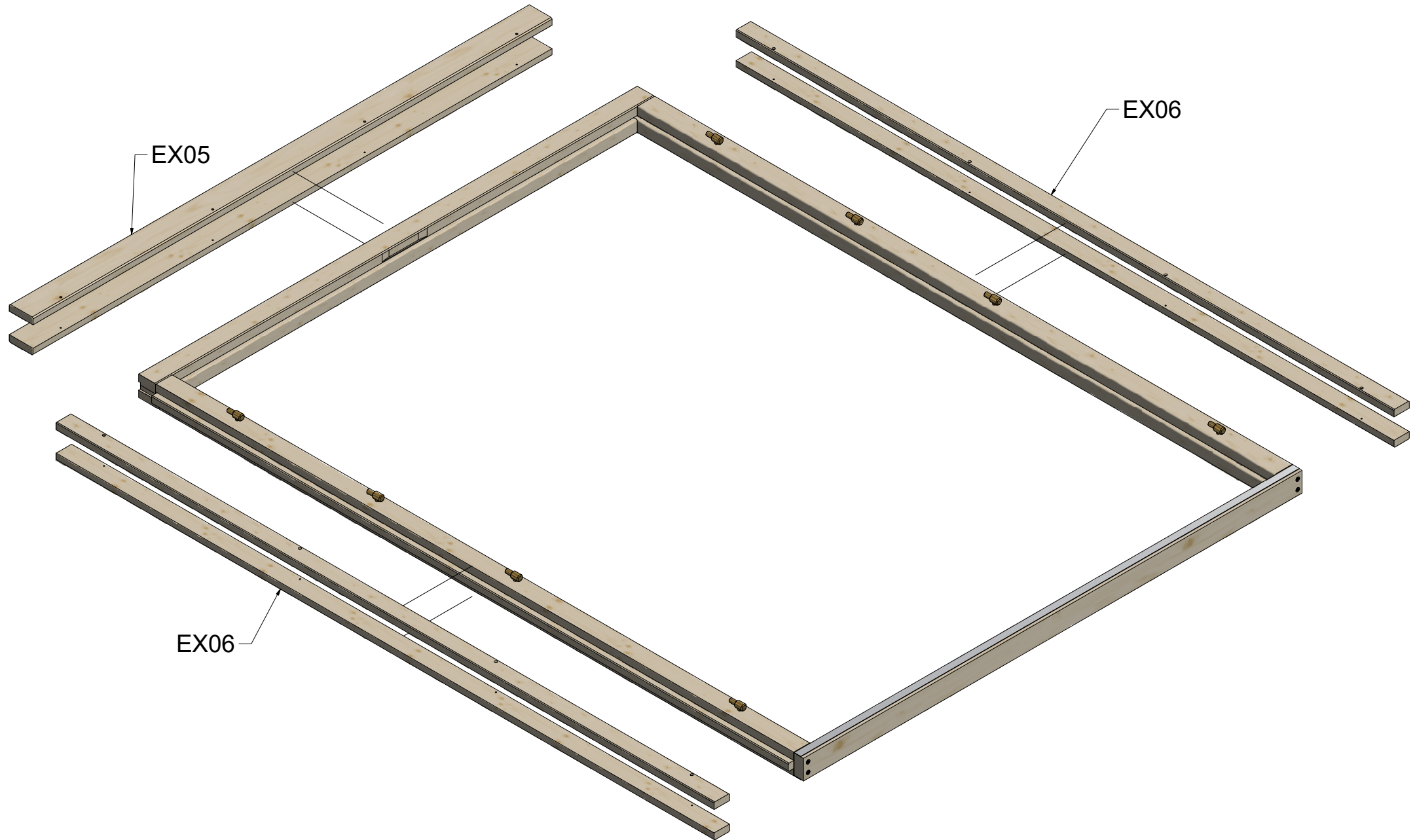

Double Door Frame 58/70mm

AA (1 : 2)

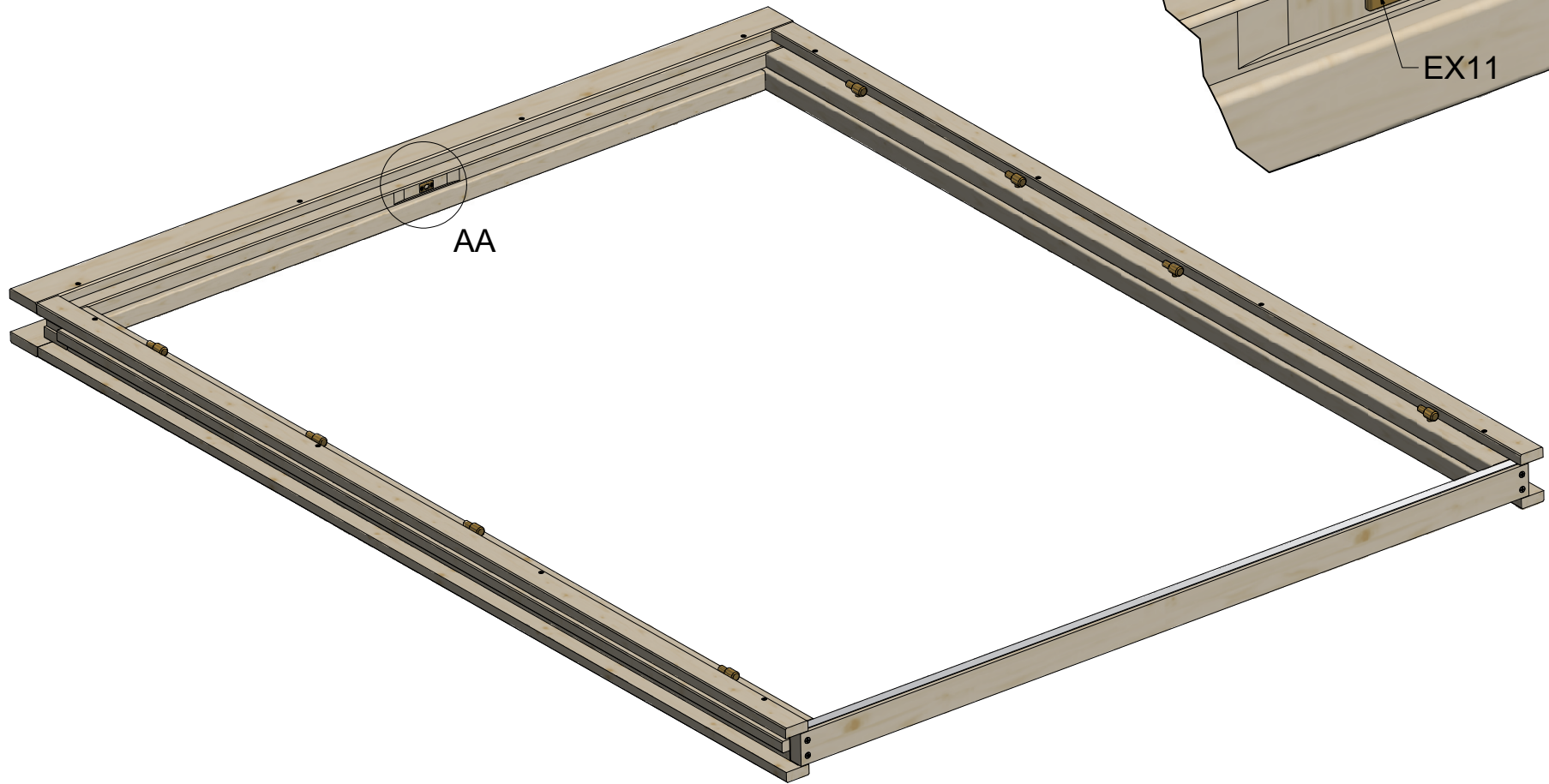
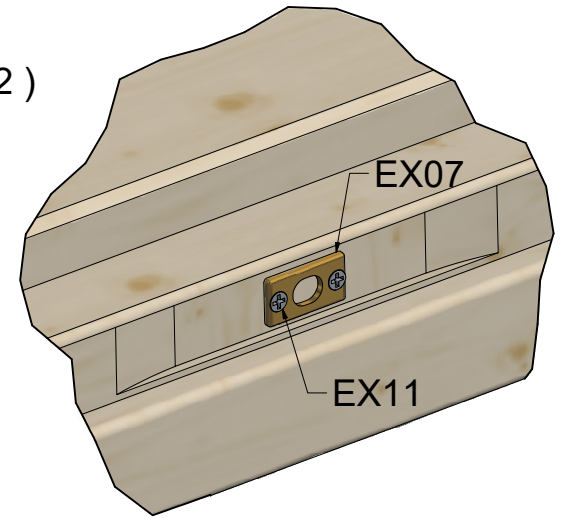

VIEW43 (1 : 20)

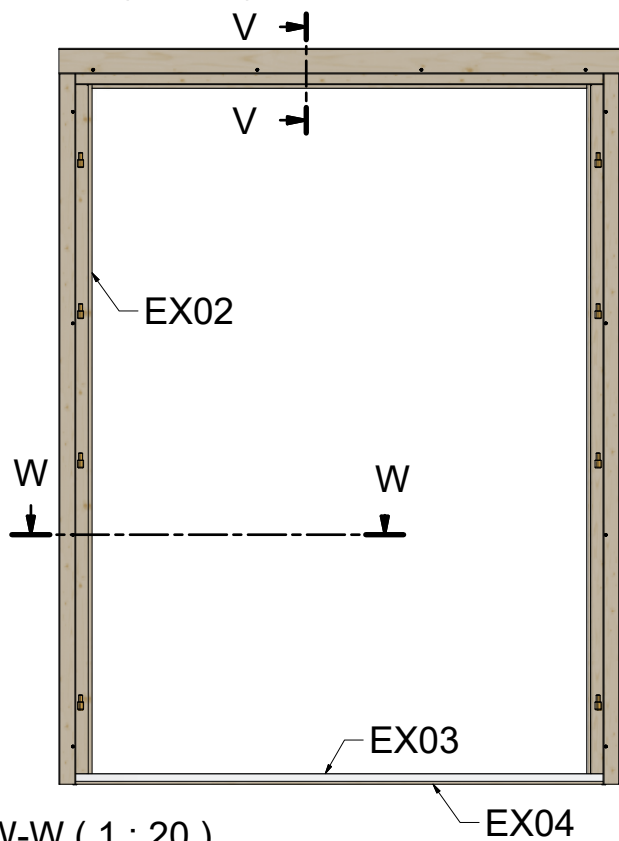

V-V (1 : 4)

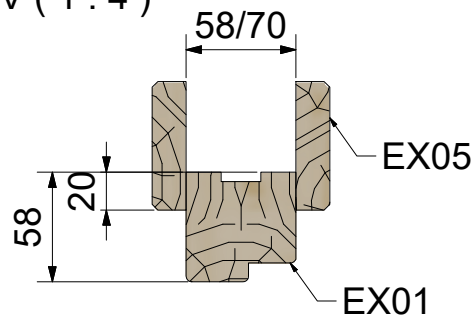







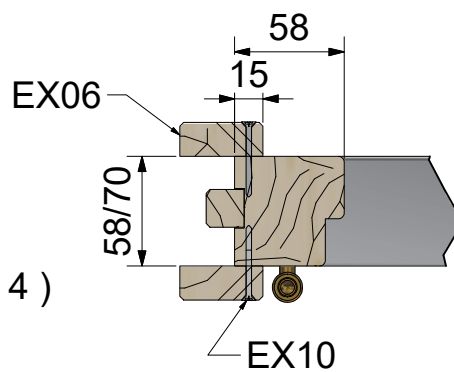









W-W (1 : 20)



Y (1 : 4)

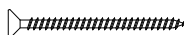

Specification Double Door Frame 58/70mm

Nr	Description	Profile	Amount
EX01		 58 X 58/70	1
EX02		 58 X 58/70	1+1
EX03		 15 X 58/70	1
EX04		 28 X 58/70	1
EX05		 18 X 68	2
EX06		 18 X 44	4
EX07			1
EX08	Screws 5,0 x 70 		4
EX09	Screws 4,0 x 50 		2
EX10	Screws 4,0 x 40 		24
EX11	Screws 3,0 x 30 		2