

EK 2420 ET-EF / HB 2420 ET-EF 40 ISO (240x200)

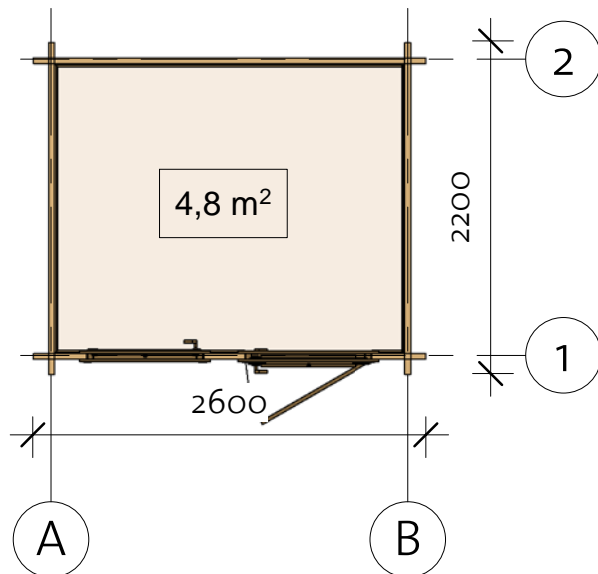

HB 2420 ET-EF 40 ISO (240X200)

Foundation

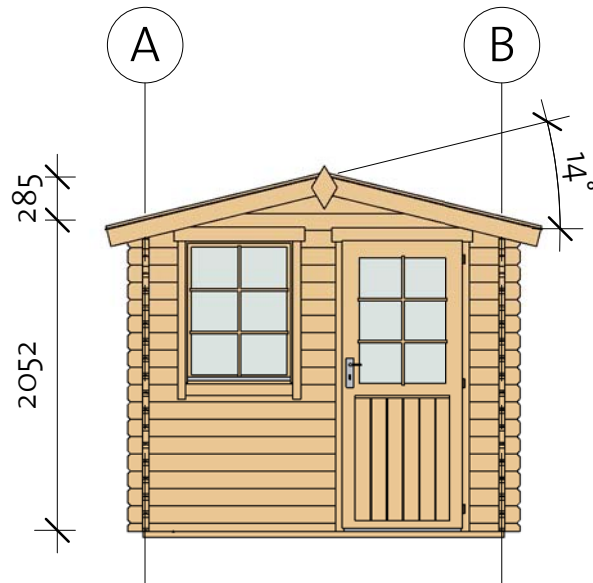
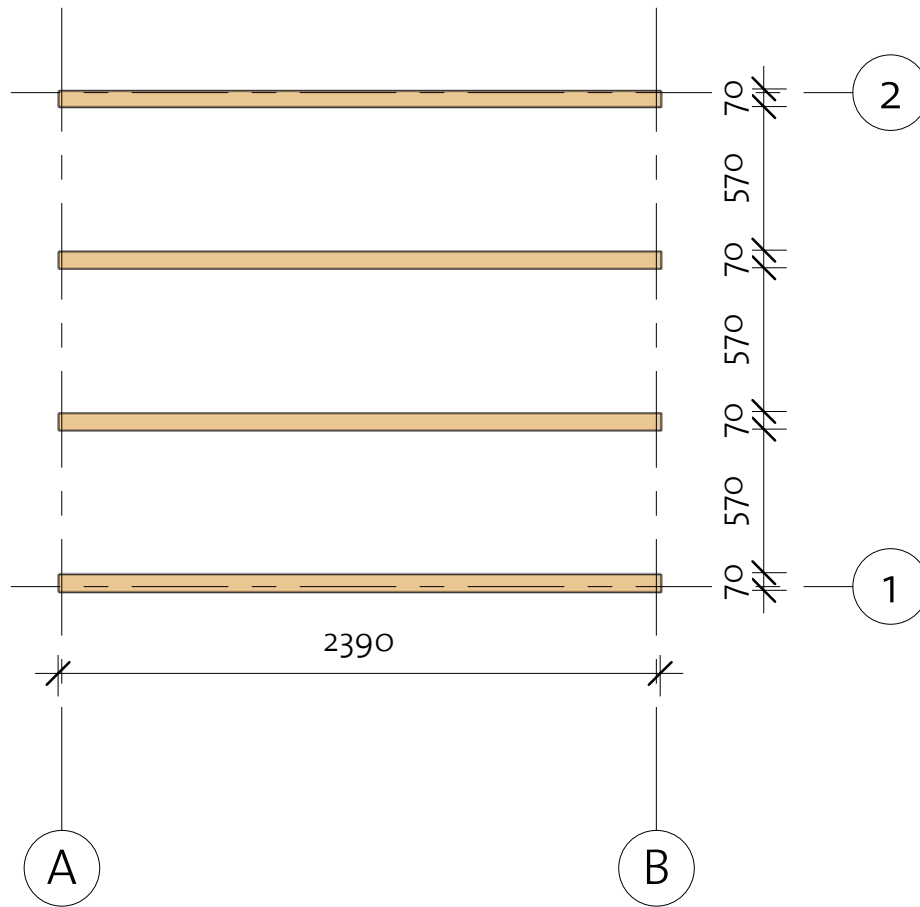

Impregnated foundation beams				
Mark	Type	Profile	Count	Length

IFB	IFB 70X40		4	2390
-----	--------------	---	---	------



HB 2420 ET-EF 40 ISO (240X200)

Floor Plan

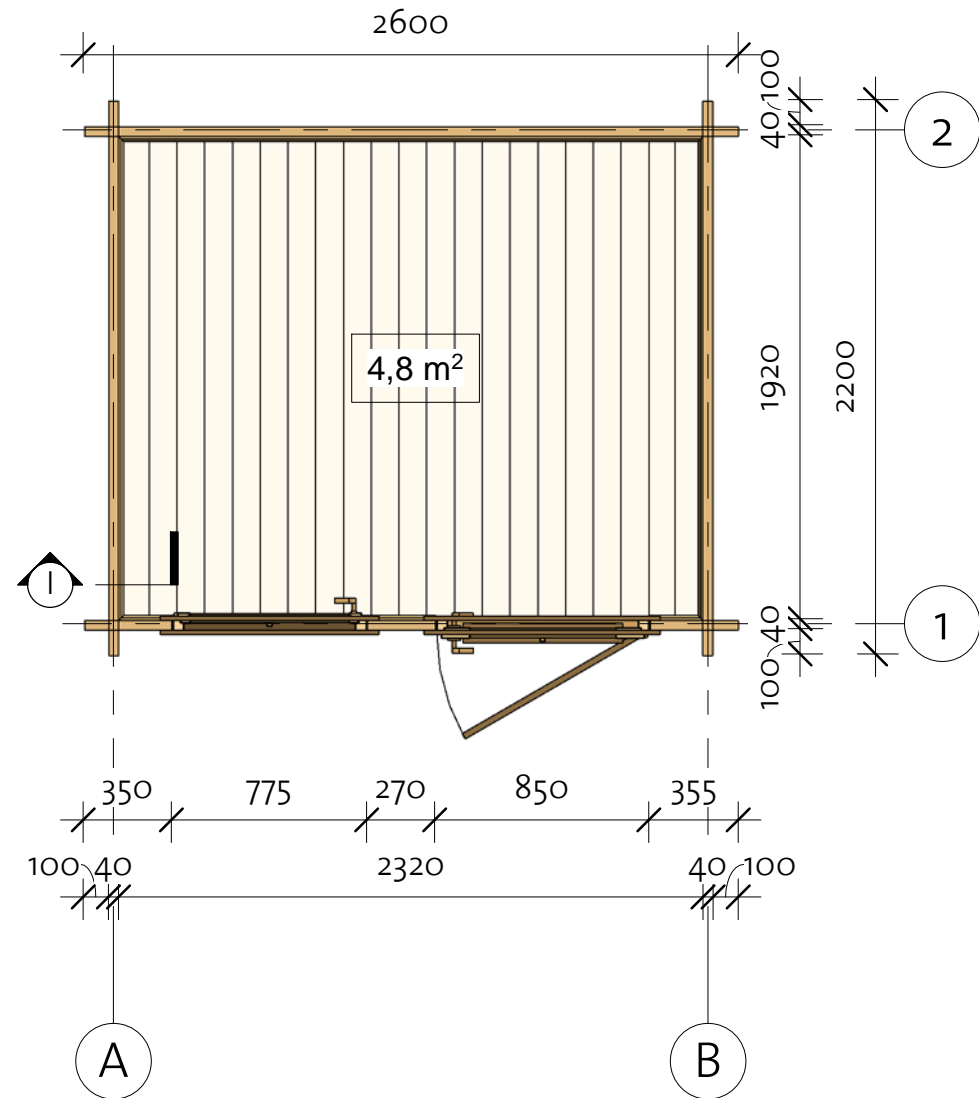
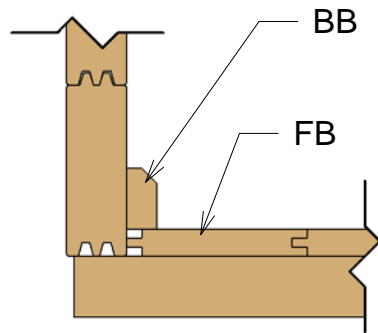
① Baseboard



Floor Schedule

Mark	Type	Profile	Count	Length
FB	FB 18x110		22	1914
BB	BB 20x40		4	2400

HB 2420 ET-EF 40 ISO (240X200)

Wall 1

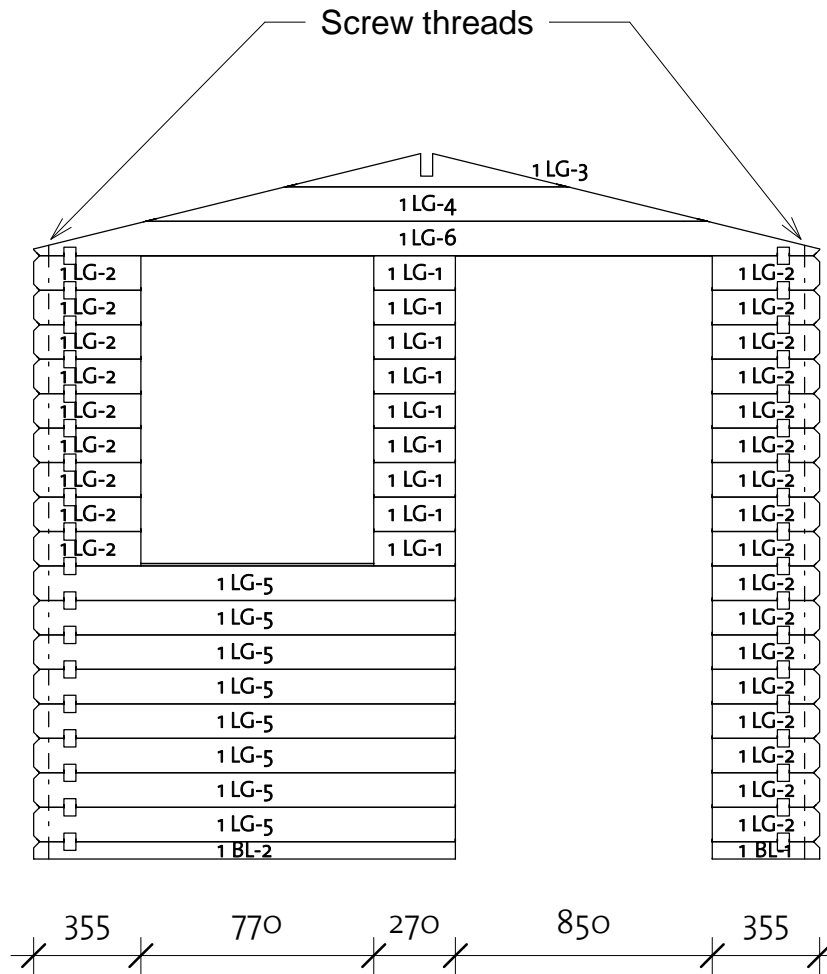



Wall 1			
Mark	Profile	Count	Cut Length

1BL-1	40X57	1	355
1BL-2	40X57	1	1395
1LG-1	40X114	9	270
1LG-2	40X114	26	355
1LG-3 *	40X114	1	932
1LG-4 *	40X114	1	1857
1LG-5	40X114	8	1395
1LG-6 *	40X114	1	2600

* Gable - delivered premounted

Log Profile Wall 1	
Profile	Profile

40X57	
40X114	

HB 2420 ET-EF 40 ISO (240X200)

Wall A



Wall A			
Mark	Profile	Count	Cut Length

ALG-1	40X114	15	2200
ALG-2	40X114	1	2300
ALG-3	40X114	1	2400
ATL-1	40X114	1	2600

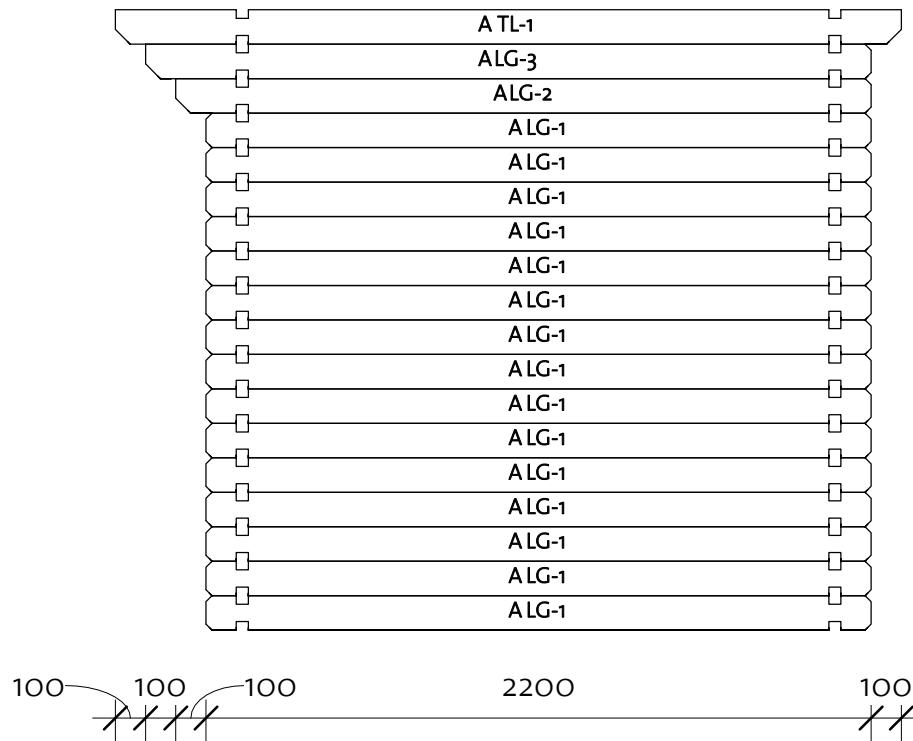

Log Profile Wall A	
Profile	Profile

40X114	
40X114	

HB 2420 ET-EF 40 ISO (240X200)

Wall B

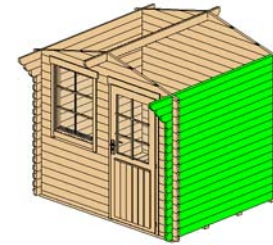

Wall B			
Mark	Profile	Count	Cut Length

BLG-1	40X114	15	2200
BLG-2	40X114	1	2300
BLG-3	40X114	1	2400
BTL-1	40X114	1	2600

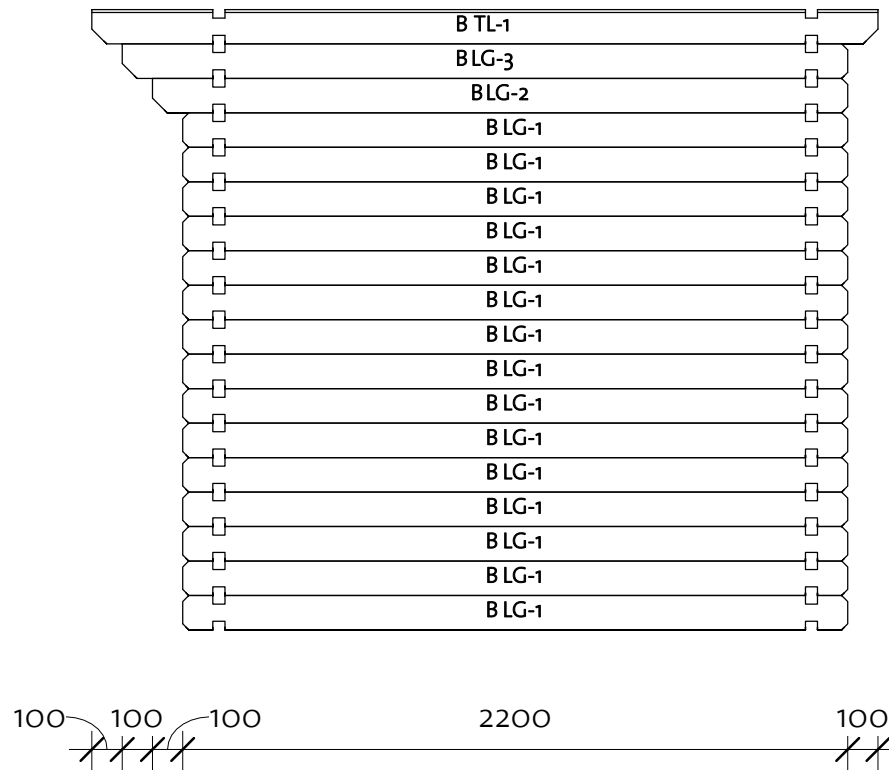



Log Profile Wall B	
Profile	Profile

40X114	
40X114	

HB 2420 ET-EF 40 ISO (240X200)

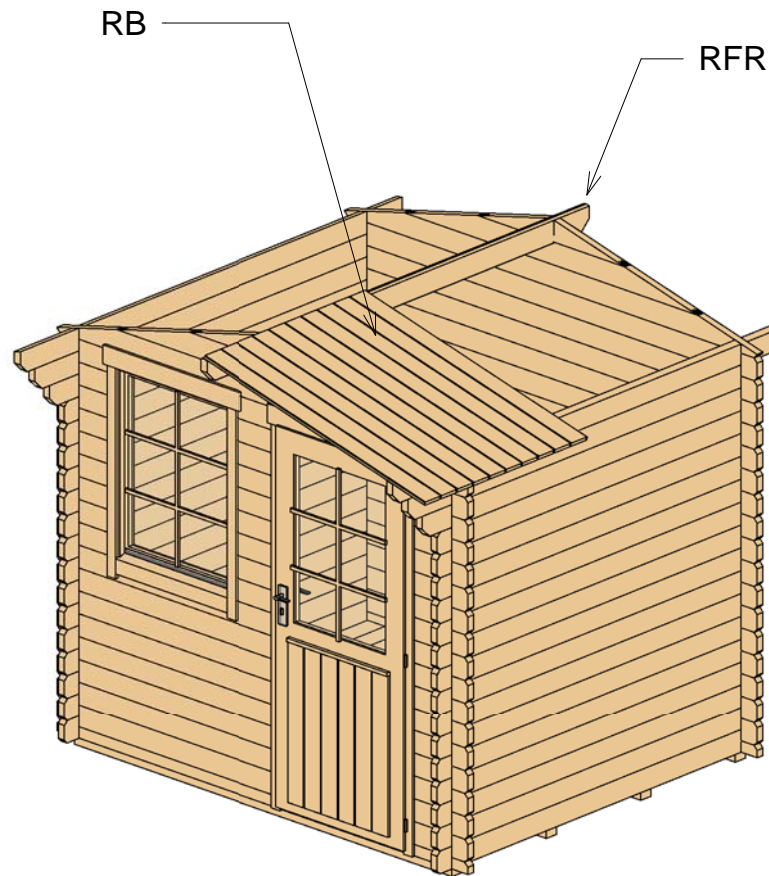
Roof 1



Roof				
Mark	Type	Profile	Count	Length
RFR	Ridge 40X120		1	2600
RB	18x110		50	1440

HB 2420 ET-EF 40 ISO (240X200)

Roof 2

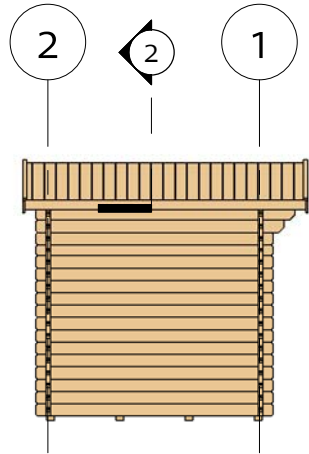

② Facia

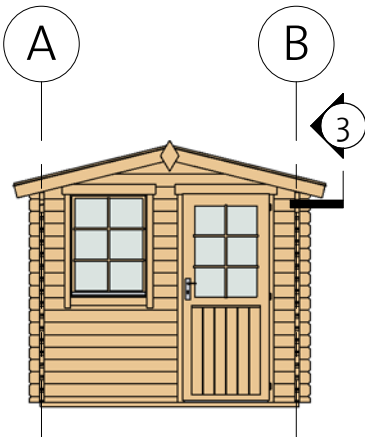
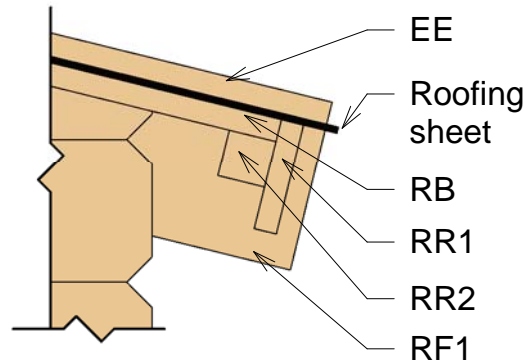

③ Roof Reinforcement

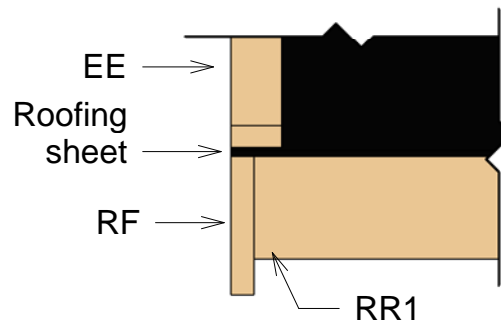

Fascia Schedule

Mark	Type	Profile	Count	Length
EE	Eave Edging 18x40		4	1480
RF	Roof Fascia 18x115		4	1480
RR1	Roof reinforcement 18x90		2	2600
RR2	Roof reinforcement 38x38		2	2600

HB 2420 ET-EF 40 ISO (240X200)

Extras



Door Schedule				
Mark	Type	Width	Height	Count
CD4R	Classic door 4 right	840	1955	1
DCB6	Door Crossbar 6	--	--	1

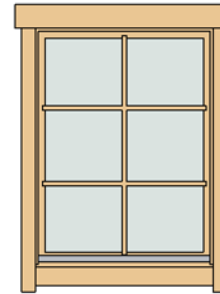

Window Schedule				
Mark	Type	Width	Height	Count
CW1R	Classic window 1 right	765	990	1
WCB6	Windows Crossbar 6	--	--	1

Fasteners & Extras		
Name	Type	Count

Hitblock	300-400 mm	
Screw thread Ø 8mm	2100 mm	4
Nut, washer	Ø 8mm	8
Screws	5,0 x 70	10
Bolts	M8 x 70	12
Nails	1,4 x 40	30
Screws	6,0 x 140	35
Screws	4,0 x 40	60
Screws	4,0x50	220

Family	Count
--------	-------



Romb	2
------	---



HB 2420 ET-EF 40 ISO (240X200)

List of all items 1



Impregnated foundation beams

Mark	Type	Profile	Count	Length
IFB	IFB 70x40		4	2390





Floor Schedule

Mark	Type	Profile	Count	Length
FB	FB 18x110		22	1914
BB	BB 20x40		4	2400

Roof

Mark	Type	Profile	Count	Length
RFR	Ridge 40x120		1	2600
RB	18x110		50	1440

Fascia Schedule

Mark	Type	Profile	Count	Length
EE	Eave Edging 18x40		4	1480
RF	Roof Fascia 18x115		4	1480
RR1	Roof reinforcement 18x90		2	2600
RR2	Roof reinforcement 38x38		2	2600

HB 2420 ET-EF 40 ISO (240X200)

List of all items 2

Wall 1			
Mark	Profile	Count	Cut Length

1BL-1	40X57	1	355
1BL-2	40X57	1	1395
1LG-1	40X114	9	270
1LG-2	40X114	26	355
1LG-3*	40X114	1	932
1LG-4*	40X114	1	1857
1LG-5	40X114	8	1395
1LG-6*	40X114	1	2600

Wall 2			
Mark	Profile	Count	Cut Length

2BL-1	40X57	1	2600
2LG-1*	40X114	1	932
2LG-2*	40X114	1	1857
2LG-3*	40X114	1	2600
2LG-4	40X114	17	2600

Wall A			
Mark	Profile	Count	Cut Length



ALG-1	40X114	15	2200
ALG-2	40X114	1	2300
ALG-3	40X114	1	2400
ATL-1	40X114	1	2600

Wall B			
Mark	Profile	Count	Cut Length

BLG-1	40X114	15	2200
BLG-2	40X114	1	2300
BLG-3	40X114	1	2400
BTL-1	40X114	1	2600

* Gable - delivered premounted

Log Profiles	
Profile	Profile

40X57	
40X114	

Log Profiles	
Profile	Profile

40X114	
--------	---