

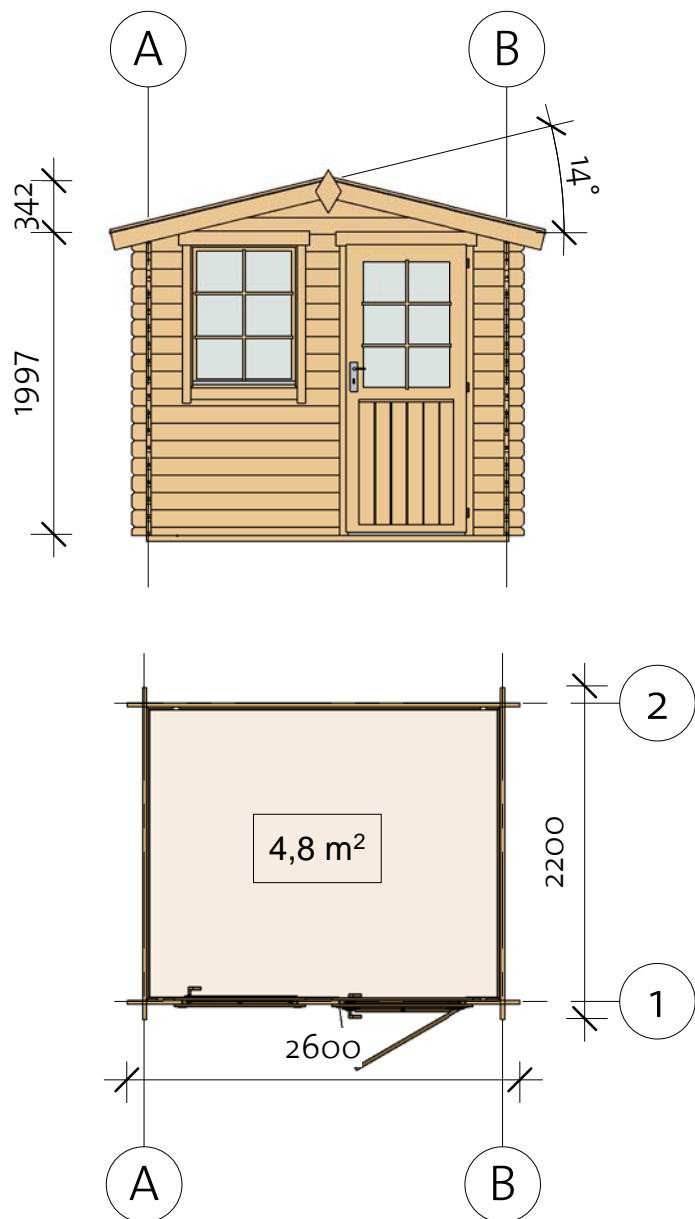

EK 2420 ET-EF 28 /HB 2420 ET-EF 28 (240X200)

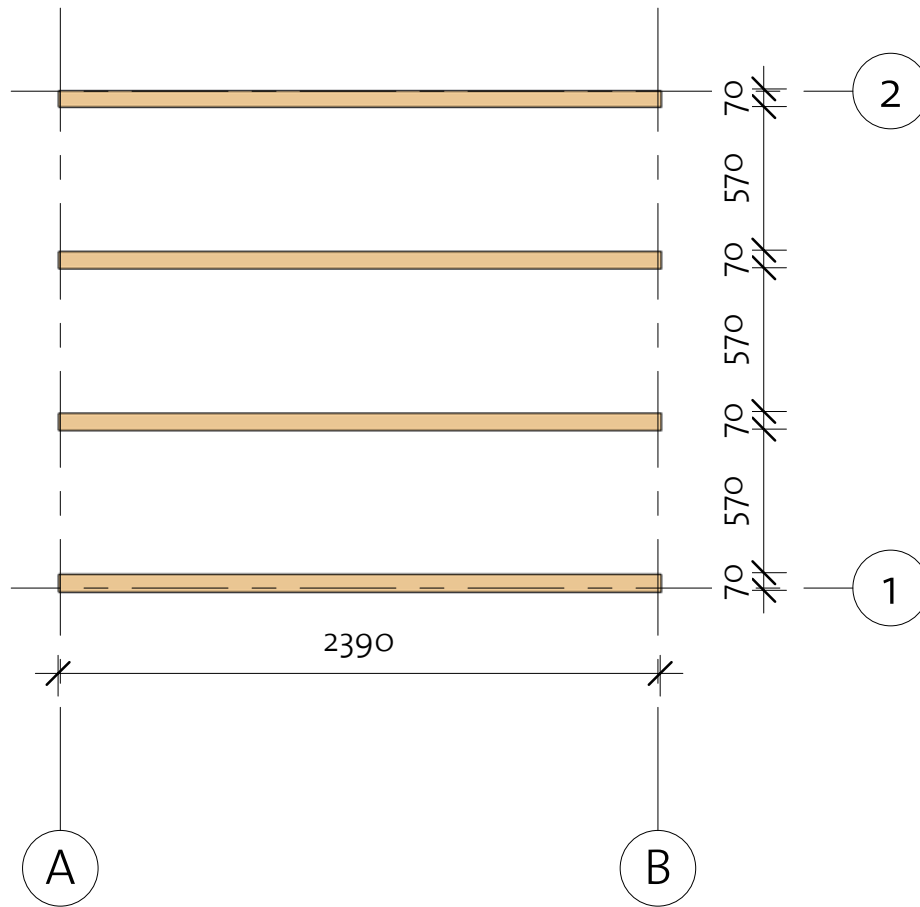

HB 2420 ET-EF 28 (240X200)

Foundation



Impregnated foundation beams				
Mark	Type	Profile	Count	Length
IFB	IFB 70X40		4	2390



HB 2420 ET-EF 28 (240X200)

Floor Plan

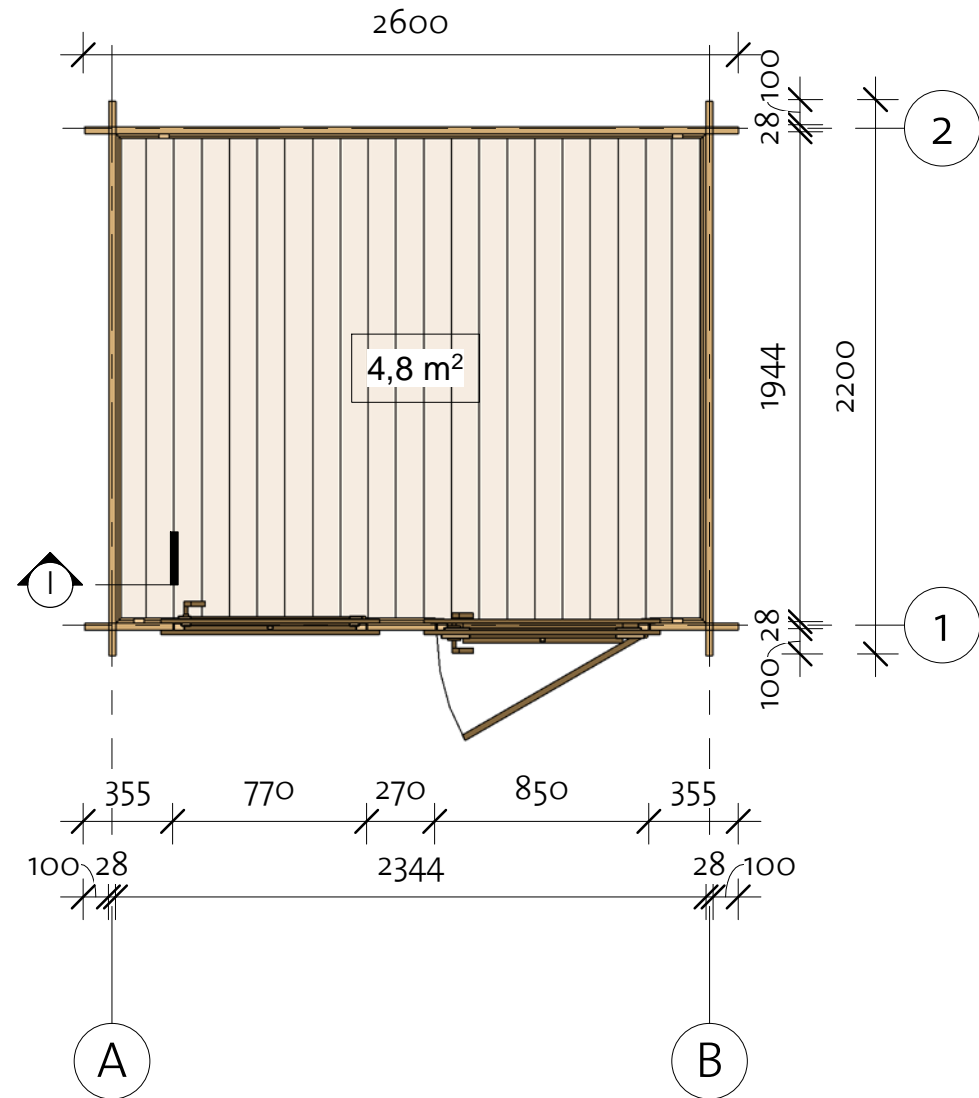
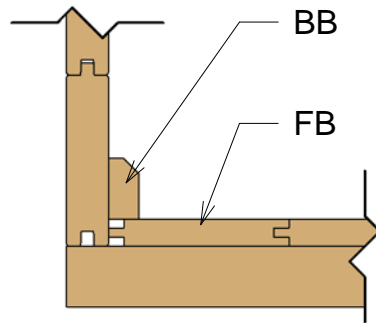
① Baseboard



Floor Schedule

Mark	Type	Profile	Count	Length
FB	FB 18x110		23	1941
BB	BB 20x40		4	2400

HB 2420 ET-EF 28 (240X200)

Wall 1

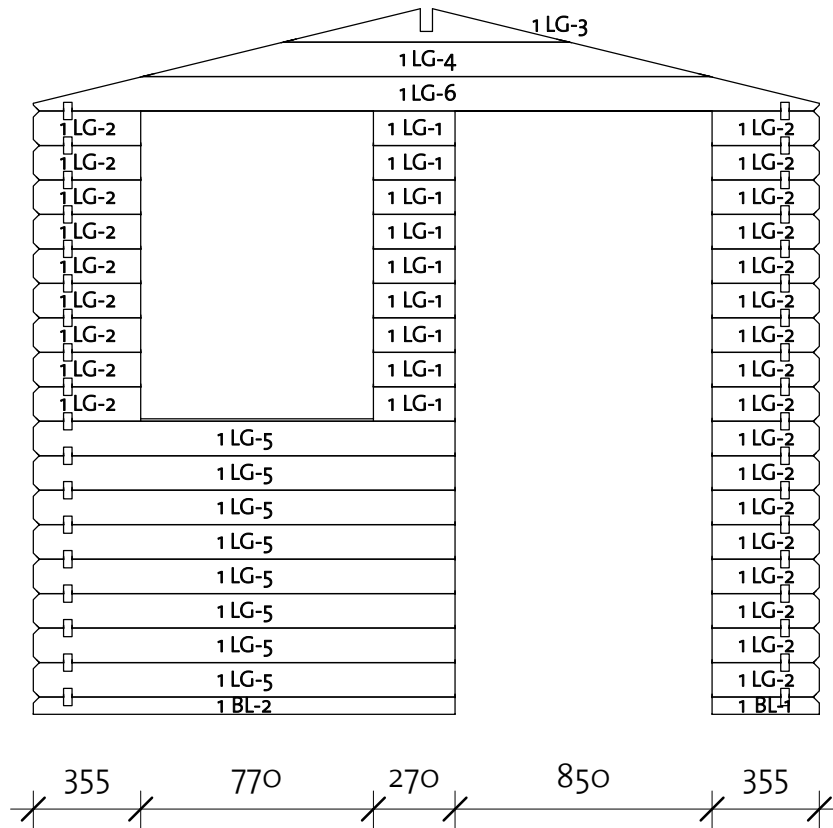



Wall 1			
Mark	Profile	Count	Cut Length

1BL-1	28x57	1	355
1BL-2	28x57	1	1395
1LG-1	28x114	9	270
1LG-2	28x114	26	355
1LG-3 *	28x114	1	944
1LG-4 *	28x114	1	1877
1LG-5	28x114	8	1395
1LG-6 *	28x114	1	2600

* Gable - delivered premounted

Log Profile Wall 1	
Profile	Profile

28x57	
28x114	

HB 2420 ET-EF 28 (240X200)

Wall 2

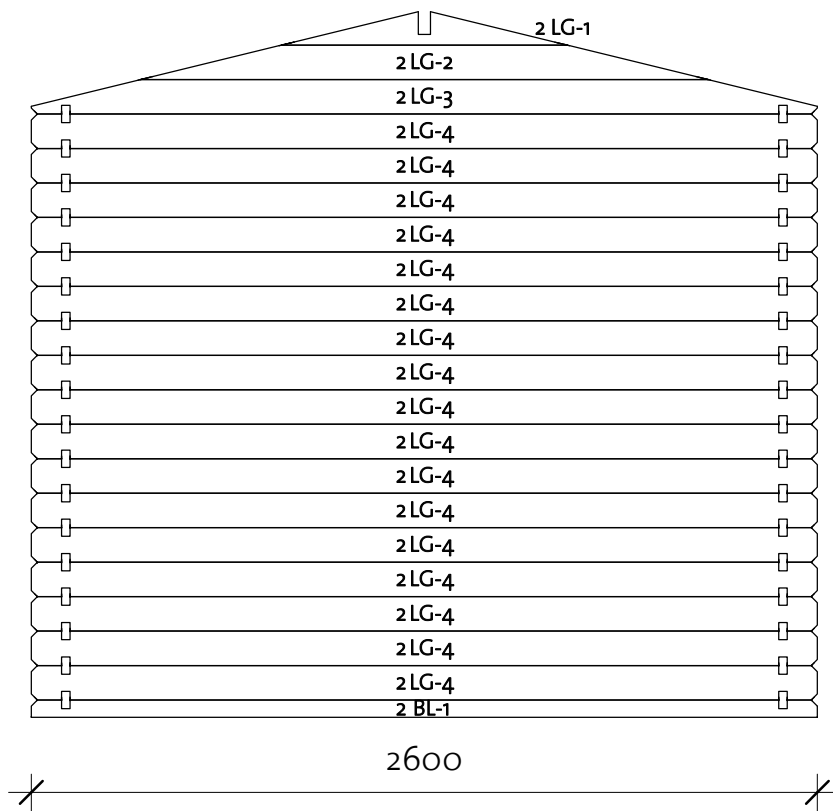
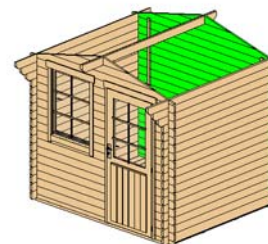

Wall 2			
Mark	Profile	Count	Cut Length

2BL-1	28x57	1	2600
2LG-1*	28x114	1	944
2LG-2*	28x114	1	1877
2LG-3*	28x114	1	2600
2LG-4	28x114	17	2600

* Gable - delivered premounted

Log Profile Wall 2	
Profile	Profile

28x57	
28x114	

HB 2420 ET-EF 28 (240X200)

Wall A



Wall A			
Mark	Profile	Count	Cut Length

ALG-1	28x114	15	2200
ALG-2	28x114	1	2300
ALG-3	28x114	1	2400
ATL-1	28x114	1	2600

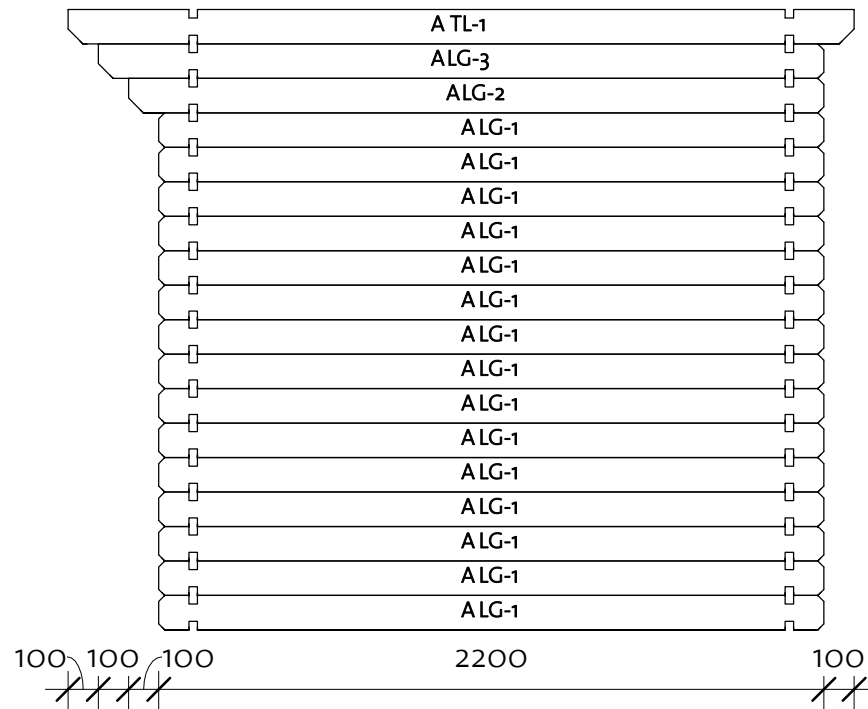

Log Profile Wall A	
Profile	Profile

28x114	
28x114	

HB 2420 ET-EF 28 (240X200)

Wall B

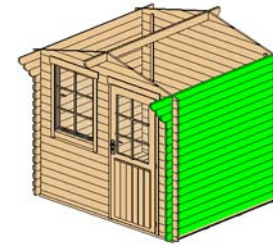

Wall B			
Mark	Profile	Count	Cut Length

BLG-1	28x114	15	2200
BLG-2	28x114	1	2300
BLG-3	28x114	1	2400
BTL-1	28x114	1	2600

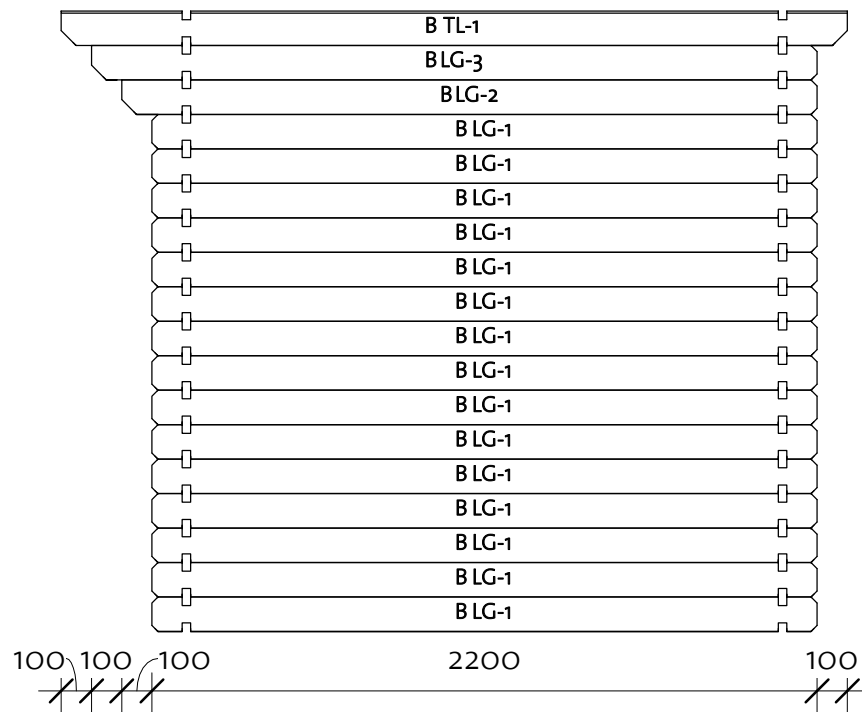



Log Profile Wall B	
Profile	Profile

28x114	
28x114	

HB 2420 ET-EF 28 (240X200)

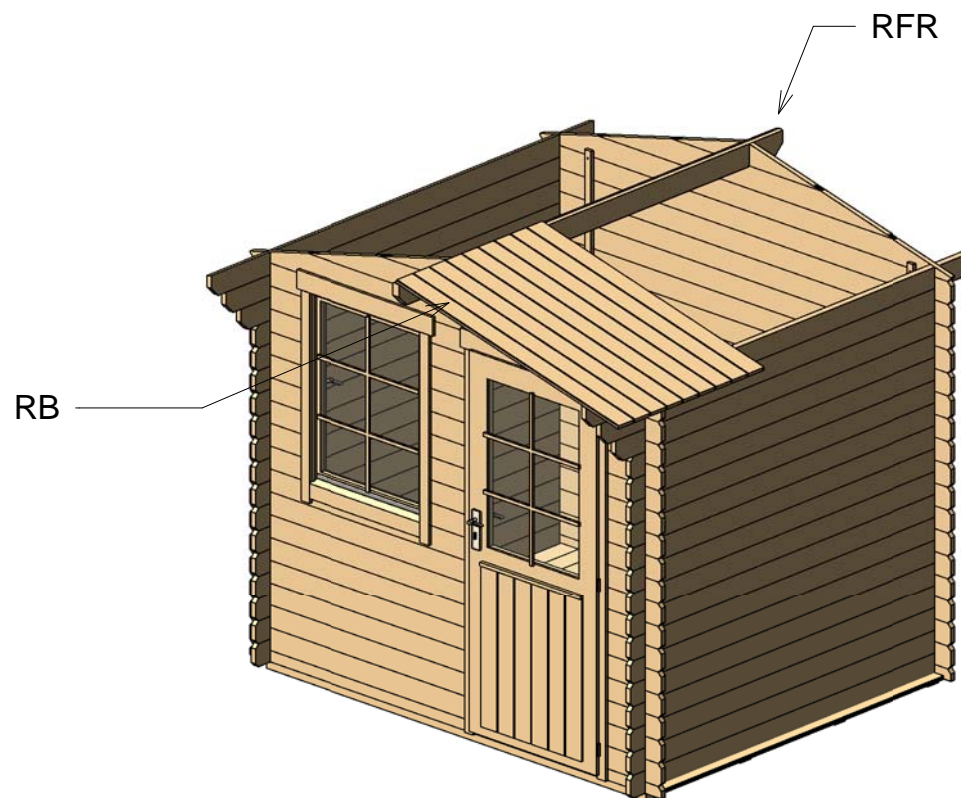
Roof 1



Roof				
Mark	Type	Profile	Count	Length
RFR	Ridge 40X120		1	2600
RB	18x110		50	1440

HB 2420 ET-EF 28 (240X200)

Roof 2

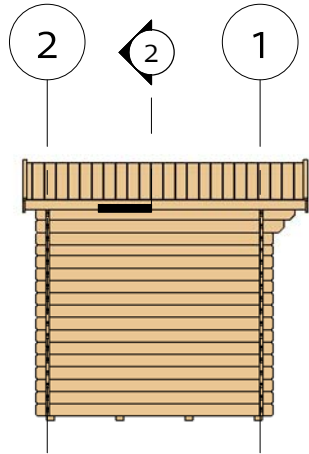

② Fascia

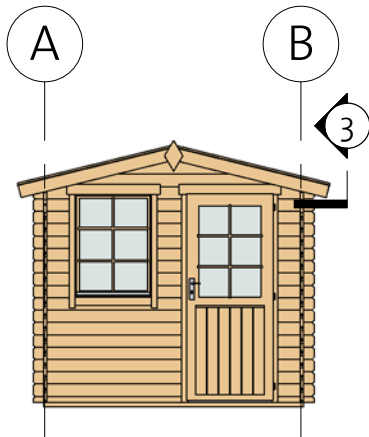
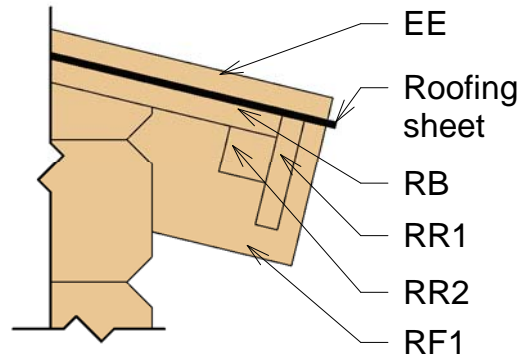

③ Roof Reinforcement

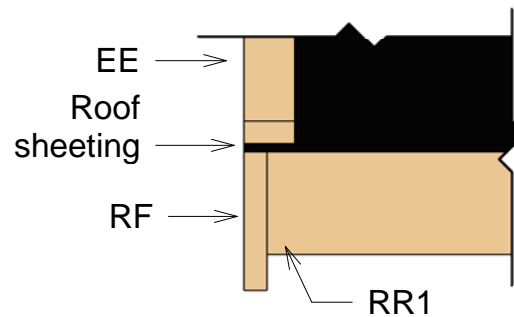

Fascia Schedule				
Mark	Type	Profile	Count	Length
EE	Eave Edging 18x40		4	1480
RF	Roof Fascia 18x115		4	1480
RR1	Roof reinforcement 18x90		2	2600
RR2	Roof reinforcement 38x38		2	2600

HB 2420 ET-EF 28 (240X200)

Extras



Door Schedule				
Mark	Type	Width	Height	Count
BD3R	Basic door 3 right	840	1955	1
DCB6	Door Crossbar 6	--	--	1

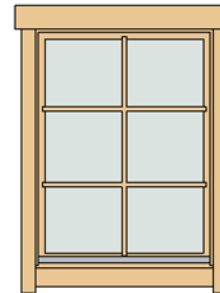

Window Schedule				
Mark	Type	Width	Height	Count
BW1R	Basic window 1 right	765	990	1
WCB6	Windows Crossbar 6	--	--	1

Fasteners & Extras		
Name	Type	Count

Hitblock	300-400 mm	
Screws	5,0 x 70	10
Bolts	M8 x 60	12
Screws	6,0 x 140	25
Nails	1,4x40	30
Screws	4,0 x 40	60
Screws	4,0 x 50	220



Type	Count	Length
Windboard 18x40	4	2200

Family	Count
Romb	2



190415



HB 2420 ET-EF 28 (240X200)

List of all items 1



Impregnated foundation beams

Mark	Type	Profile	Count	Length
IFB	IFB 70x40		4	2390





Floor Schedule

Mark	Type	Profile	Count	Length
FB	FB 18x110		23	1941
BB	BB 20x40		4	2400

Roof

Mark	Type	Profile	Count	Length
RFR	Ridge 40x120		1	2600
RB	18x110		50	1440

Fascia Schedule

Mark	Type	Profile	Count	Length
EE	Eave Edging 18x40		4	1480
RF	Roof Fascia 18x115		4	1480
RR1	Roof reinforcement 18x90		2	2600
RR2	Roof reinforcement 38x38		2	2600

HB 2420 ET-EF 28 (240X200)

List of all items 2

Wall 1			
Mark	Profile	Count	Cut Length

1BL-1	28x57	1	355
1BL-2	28x57	1	1395
1LG-1	28x114	9	270
1LG-2	28x114	26	355
1LG-3*	28x114	1	944
1LG-4*	28x114	1	1877
1LG-5	28x114	8	1395
1LG-6*	28x114	1	2600

Wall 2			
Mark	Profile	Count	Cut Length

2BL-1	28x57	1	2600
2LG-1*	28x114	1	944
2LG-2*	28x114	1	1877
2LG-3*	28x114	1	2600
2LG-4	28x114	17	2600

Wall A			
Mark	Profile	Count	Cut Length



ALG-1	28x114	15	2200
ALG-2	28x114	1	2300
ALG-3	28x114	1	2400
ATL-1	28x114	1	2600

Wall B			
Mark	Profile	Count	Cut Length

BLG-1	28x114	15	2200
BLG-2	28x114	1	2300
BLG-3	28x114	1	2400
BTL-1	28x114	1	2600

* Gable - delivered premounted

Log Profiles	
Profile	Profile

28x57	
28x114	

Log Profiles	
Profile	Profile

28x114	
--------	---