

Installation manual

Montageanleitung • Notice de montage • Istruzioni per il montaggio • Manual de montaje • Monteringsanvisning •
Installatiegids • Montážní návod • Asennusohje • Installationsmanual • Paigaldusjuhend

Log cabin FR70-5656-2

Blockhaus • Maisonnette en poutres • Casa di travi • Casa de jardin • Anneks • Tuinhuis • Zahradní domek •
Timmerstuga • Hirsimökki • Freesprussmaja

Width 560 x Depth 560 cm







Breite/Tiefe • Largeur/Profondeur • Lunghezza/Profondità • Ancho/Profundidad • Bredde/Dybde • Breedte/Diepte
• Šířka/Hloubka • Leveys/Pituus • Bredd/Längd • Laius/pikkus

Log thickness 70 mm

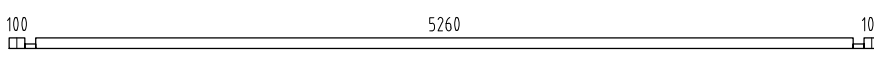
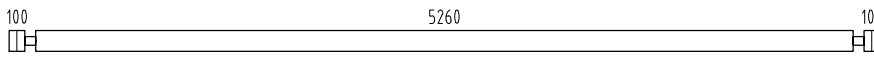
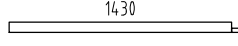
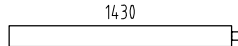
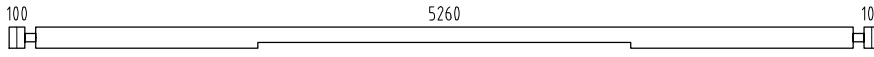
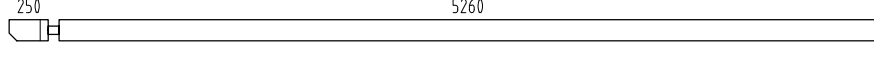
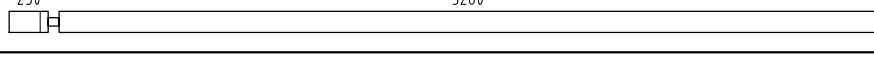

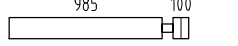
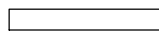
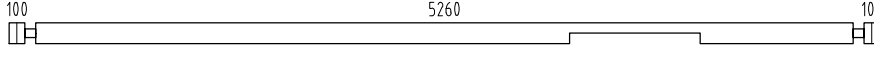
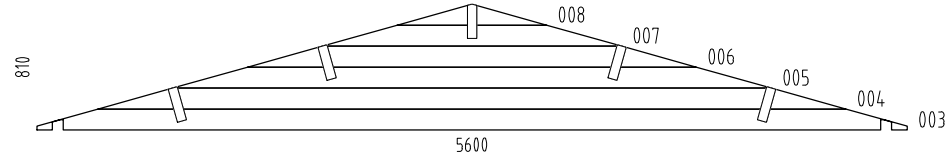
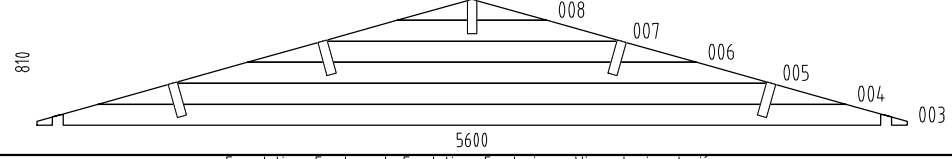
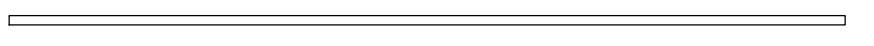
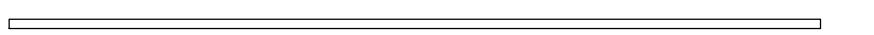
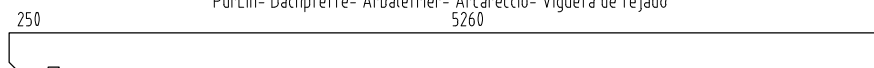
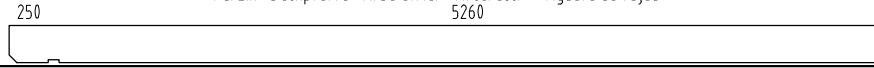
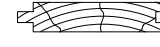

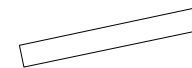
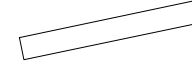



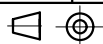

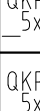
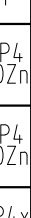

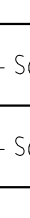
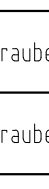
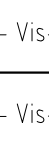
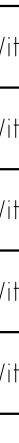
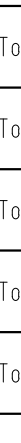

Bohlenstärke • Épaisseur des murs • Spessore delle pareti • Grosor de pared • Tykkelse • Wanddicke • Tloušťka
stěny • Seinän paksuus • Väggtjocklek • Seinapaksus





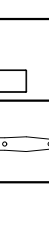



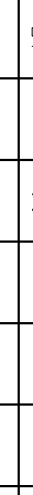
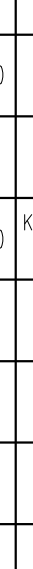
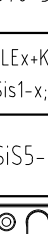
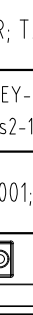

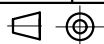





The producer shall have the right to make technical changes to the product • Technische Änderungen vorbehalten • Le
producteur réserve le droit d'effectuer des modifications techniques au produit • Il produttore mantiene il diritto di apportare
modifiche tecniche al prodotto • Reservado el derecho a modificaciones técnicas • Produsent forbeholder seg retten til å endre
tekniske egenskaper ved produktet • Alle rechten en technische wijzigingen voorbehouden • Výrobce si vyhrazuje právo na
technické změny výrobku • Valmistaja pidättää oikeuden tehdä tuotteeseen teknisiä muutoksia • Tillverkaren har rätt att utföra
tekniska förändringar för produkten • Tootja jätab endale õiguse muuta toote tehnilisi omadusi

Pos	SPECIFICATION-STÜCKLISTE-NOMENCLATURE-ELEMENTI-ESPECIFICACIÓN FR70-5656	Pcs	Profile (mm)	Length (mm)
001		1	70x68	5600
002		32	70x135	5600
009		2	70x68	1600
010		28	70x135	1600
011		1	70x135	5600
012		2	70x135	5900
013		2	70x135	5900
014		6	70x135	3605
015		22	70x135	1155
016		8	70x135	1155
017		1	70x135	5600
W1-1		1		
W2-1		1		
AR1	Foundation- Fundament- Fondation- Fondazione- Vigas de cimentación 	2	80x60	5380
AR2	Foundation- Fundament- Fondation- Fondazione- Vigas de cimentación 	2	80x60	5220
PR1	Purlin- Dachpfette- Arbalétrier- Arcareccio- Vigueta de tejado 	4	60x240	5900
PR2	Purlin- Dachpfette- Arbalétrier- Arcareccio- Vigueta de tejado 	1	60x240	5900
RB2-1	Roof board- Dachbrett- Madrier du toit- Tavola tetto- Tabla de tejado 	134	89x19	3205
Dia-1	Diamond- Deckbrett- Madrier- Tavola di copertura- Rombo 	2	19x140	300
EaE1-1	Eave edging- Dachrandbrett- Madrier en bordure du toit- Tavola bordo tetto- Tabla de valadizo 	4	16x95	2950
FaB7-1	Facia board- Giebelblende- Écran frontal- Schermo frontone- Tabla de facia 	8	19x120	3245
FaB6-1	Facia board- Giebelblende- Écran frontal- Schermo frontone- Tabla de facia 	4	19x95	3245
RE2-1	Roof edge reinforcement- Dachrandleiste- Baguette en bordure du toit- Refuerzo bordo tetto- Refuerzo borde tejado 	2	32x40	2650

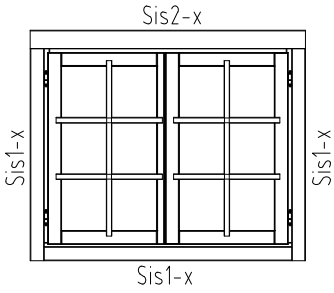

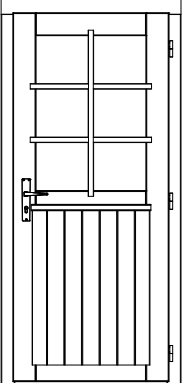
Pos	SPECIFICATION-STÜCKLISTE-NOMENCLATURE-ELEMENTI-ESPECIFICACIÓN FR70-5656	Pcs	Profile (mm)	Length (mm)	
RE2-2	Roof edge reinforcement- Dachrandleiste- Baguette en bordure du toit- Rinforzo bordo tetto- Refuerzo borde tejado		2	32x40	3250
Sis5-1	Side slat - Randleiste - Baguette en bordure - Llistello bordo 5		2	28x45	911
Sis1-1	Side slat - Randleiste- Baguette en bordure- Llistón de borde- Llistello bordo		4	19x70	1072
Sis1-2	Side slat - Randleiste- Baguette en bordure- Llistón de borde- Llistello bordo		2	19x70	1254
Sis2-1	Side slat - Randleiste- Baguette en bordure- Llistón de borde- Llistello bordo		2	19x95	1394
Fim	-Fixing kit- Befestigungsset- Moyens de fixation- Materiale di fissaggio- Kit de fijación		1	USE	
QULSI30x 35	Cylinder- Zylinderschloss- Serrure a mortaiser- Serratura a cilindro- Bombin- 30.35		1	U70-32P	
KULE P-126	Detail- Detail- Detail- Dettaglio- Detalle- KULEP-126 TU70-82P		1	Wall2	
KULE V-126	Detail- Detail- Detail- Dettaglio- Detalle- KULEV-126 TU70-82P		1	Wall2	
KULE Y-74	Detail- Detail- Detail- Dettaglio- Detalle- KULEY-74 TU70-82P		1	Wall2	
QLIU KAPal	Door fittings- Türbeschlag- Ferrure- Ferramenta porta- Manilla puerta- QLIUKAPal		1	U70-32P	
QNU20x2 0x40	L-iron- Winkel- Angle -Angolo- Angulo 20x20x40		20	ARx+Wall; 011	
QNA3x70 Zn	Nail- Nagel- Clou- Chiodo- Clavo- 3x70mm		550	RB2-1	
QKRPP3x 20Zn	Screw- Schraube- Vis- Vite- Tornillo- 3x20mm		18	U70-32R; TA70-22V	
QKRPP4 _5x50Zn	Screw- Schraube- Vis- Vite- Tornillo- 4.5x50mm		200	KULEx+KULEY-74; EaE1-1; Sis1-x; Sis2-1; FaBx-	
QKRPP4 _5x70Zn	Screw- Schraube- Vis- Vite- Tornillo- 4.5x70mm		30	Sis5-1; 001; 009; 013	
QKRPP4x 16Zn	Screw- Schraube- Vis- Vite- Tornillo- 4x16mm		2		
QKRYP5x 40ZnTX	Screw- Schraube- Vis- Vite- Tornillo- 5x40mm		76		
QKRPP5x 90Zn	Screw- Schraube- Vis- Vite- Tornillo- 5x90mm		4	KULEY-74	
QKRPP6x 120Zn	Screw- Schraube- Vis- Vite- Tornillo- 6x120mm		8	ARx	
QKRPP6x 180Zn	Screw- Schraube- Vis- Vite- Tornillo- 6x180mm		20	PRx	
QLIA-V	Window fittings- Fenstergriff- Poigne de la fenêtre- Maniglia finestra- Manilla- QLIA-V		1	TA70-22V	
QFK240Z n	Window stop- Fensterfeststelle- Crémaillère- Fissativo finestra- Fijador de ventana- QFK240Zn		2	TA70-22V	



Pos	SPECIFICATION-STÜCKLISTE-NOMENCLATURE-ELEMENTI-ESPECIFICACIÓN FR70-5656	Pcs	Profile (mm)	Length (mm)
KL1	Threaded rod- Gewindestangen- Barre fileté- Asta filettata- Varilla roscada M10 	8		2000
KL2	Threaded rod- Gewindestangen- Barre fileté- Asta filettata- Varilla roscada M10 	4		340
KL3	Threaded rod- Gewindestangen- Barre fileté- Asta filettata- Varilla roscada M10 	4		270
	Nut- Schraubenmutter- Écrou- Dado- Tuerca- M10mm 	8	KLx	
	Washer- Dichtscheibe- Joint- Rondella- Arandela- 10x30mm 	8	KLx	
	Extension nut- Verlängerungsmutter- Écrou rallonge- Dado di prolunga- Tuerca de extensión- JM10 	8	KLx	
	Captive nut- Einschlagmutter- Écrou a griffes- Dado a ragno filettatura- Tuerca arana- LM10 	8	KLx	
TA70-22 V	Window - Fenster - Fenetre - Finestra-Ventana 1290x1044  1174x928mm 	1		
U70-32P	Door - Tür - Porte - Porta-Puerta 835x1900  735x1831mm 	1		
 	Object name FRE70-5656		Page	3/3

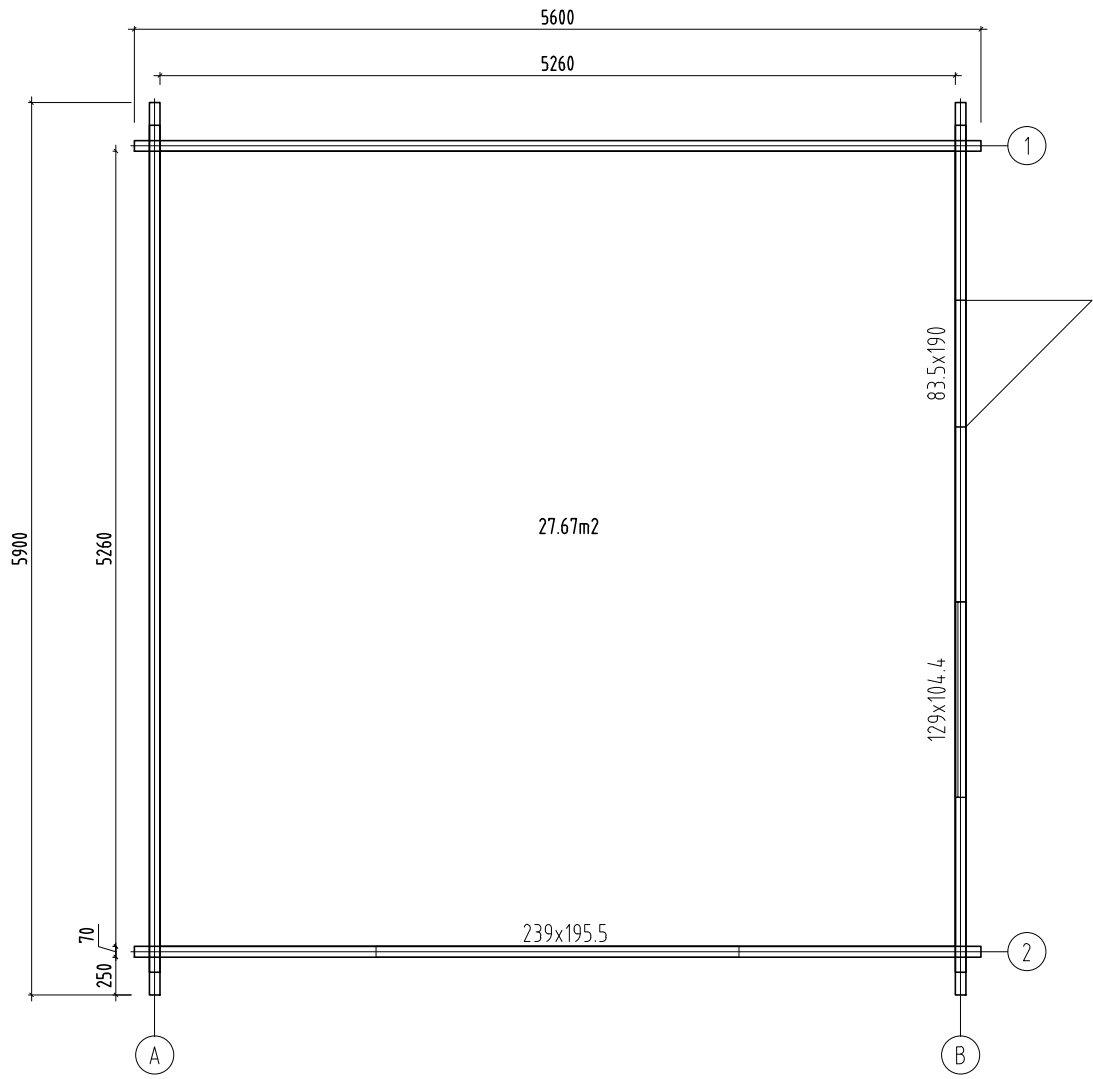

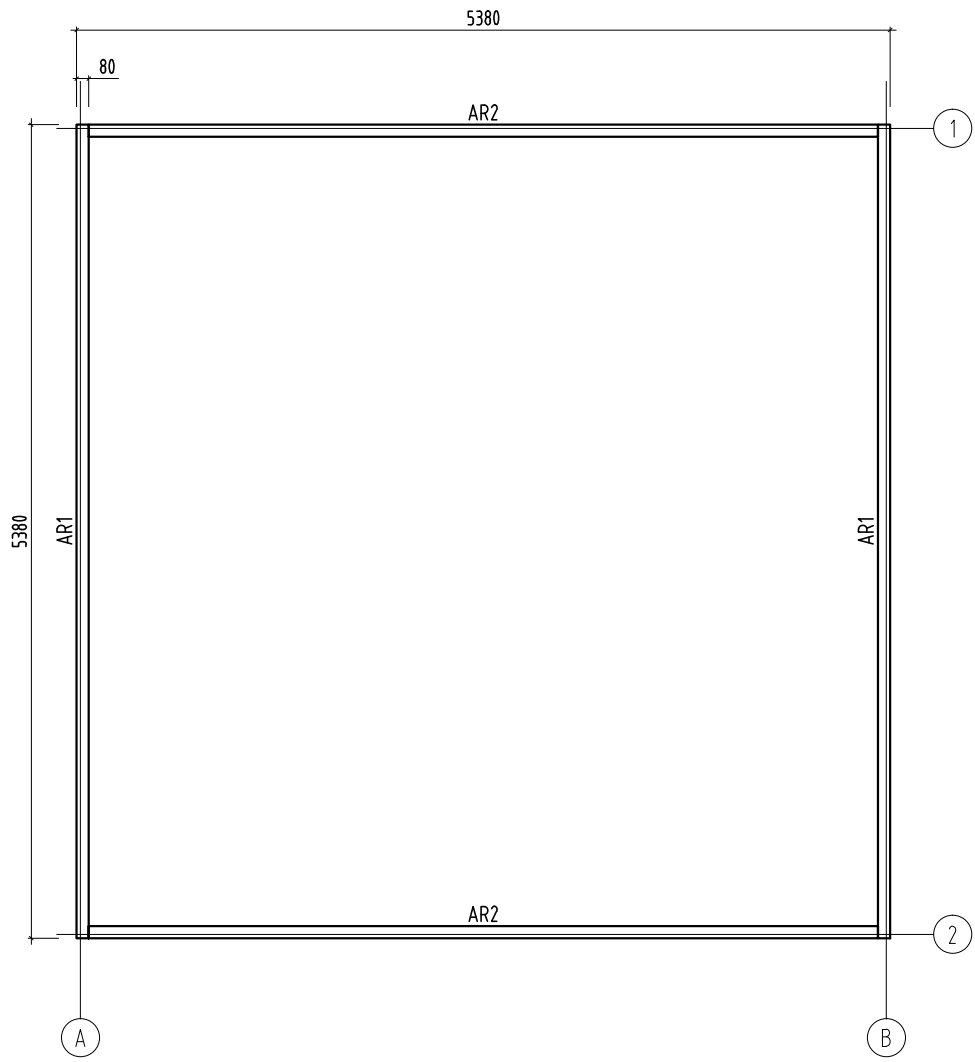

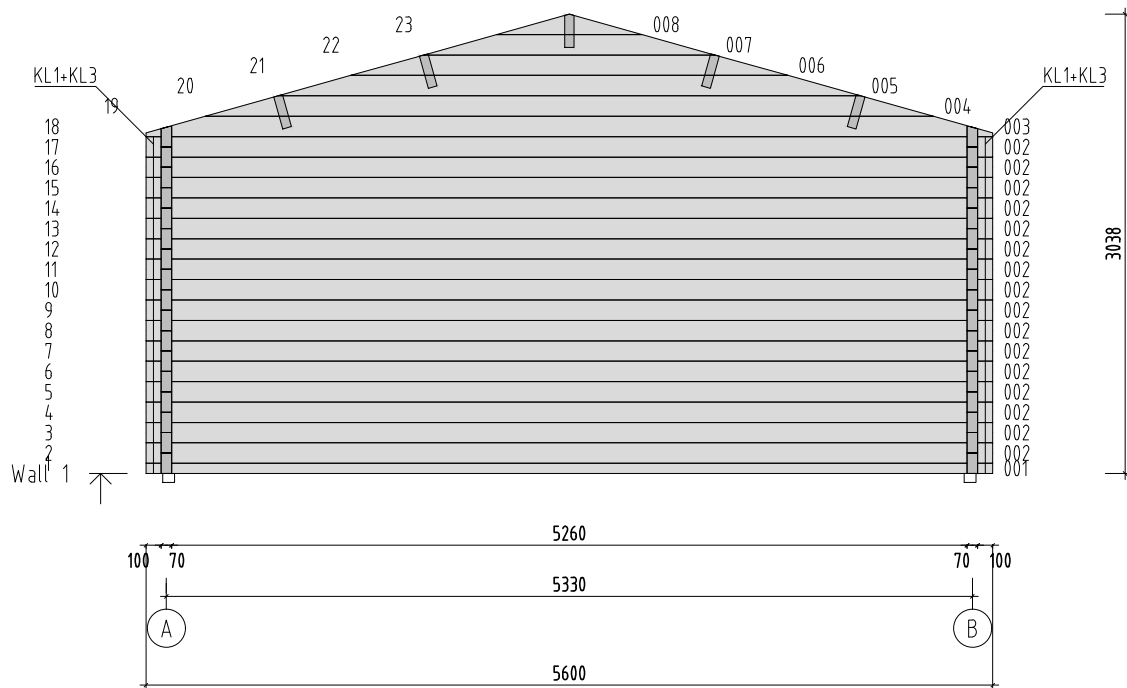

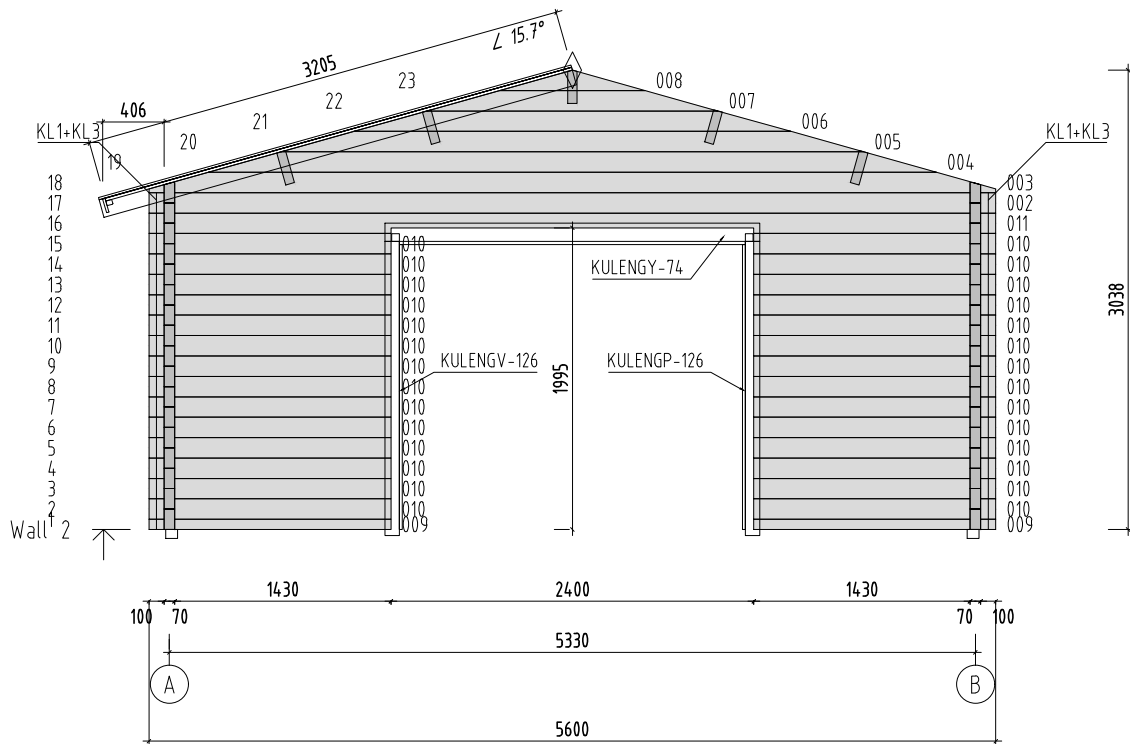

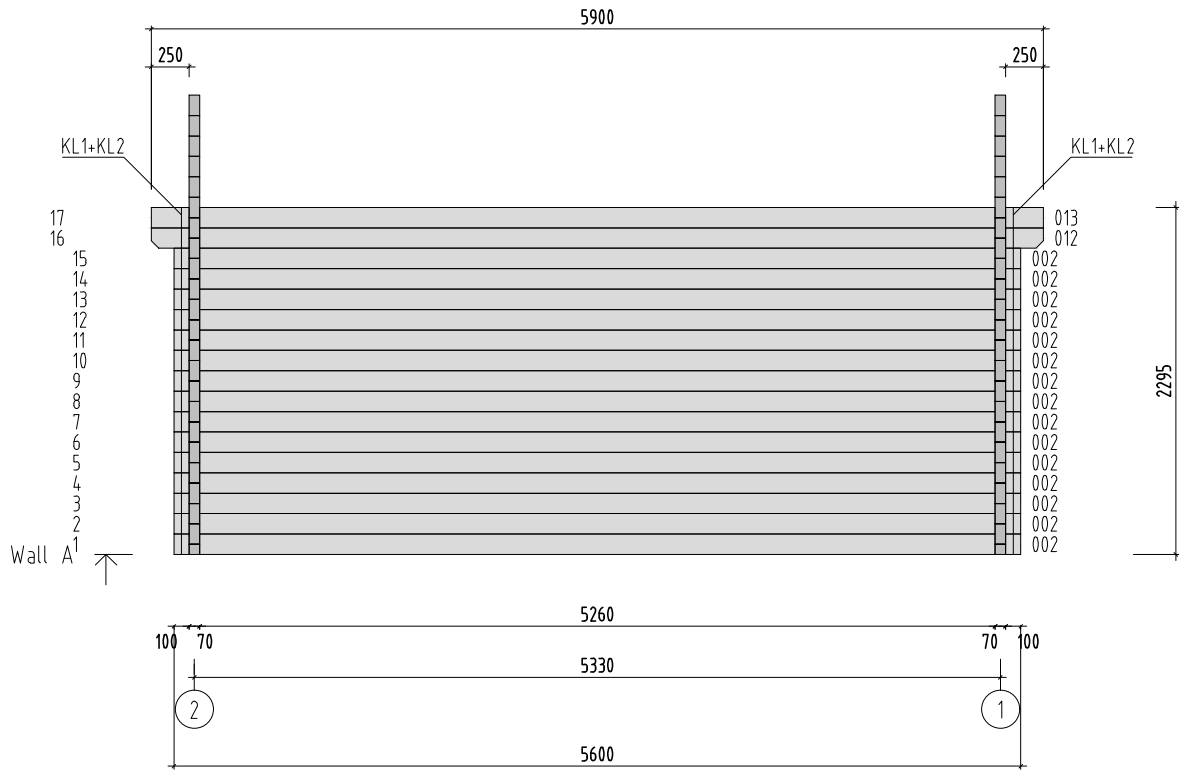

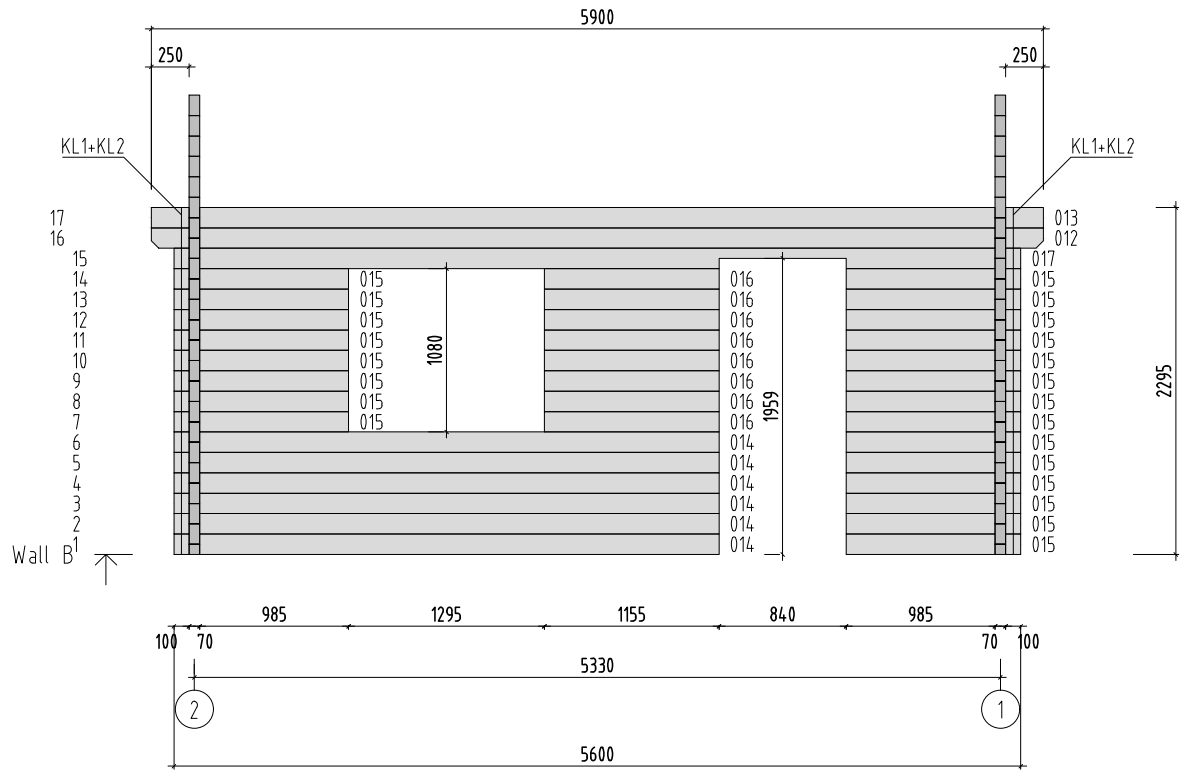

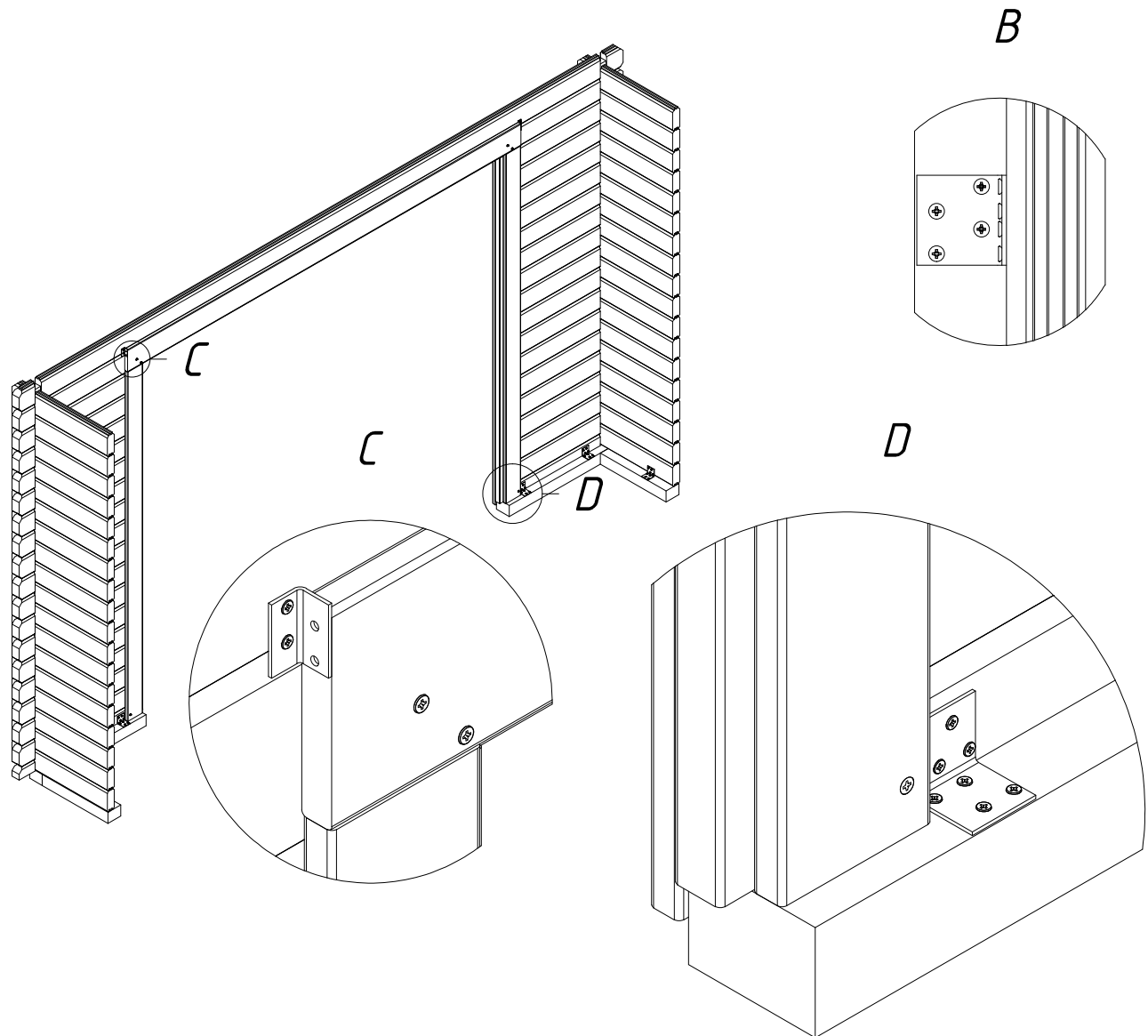
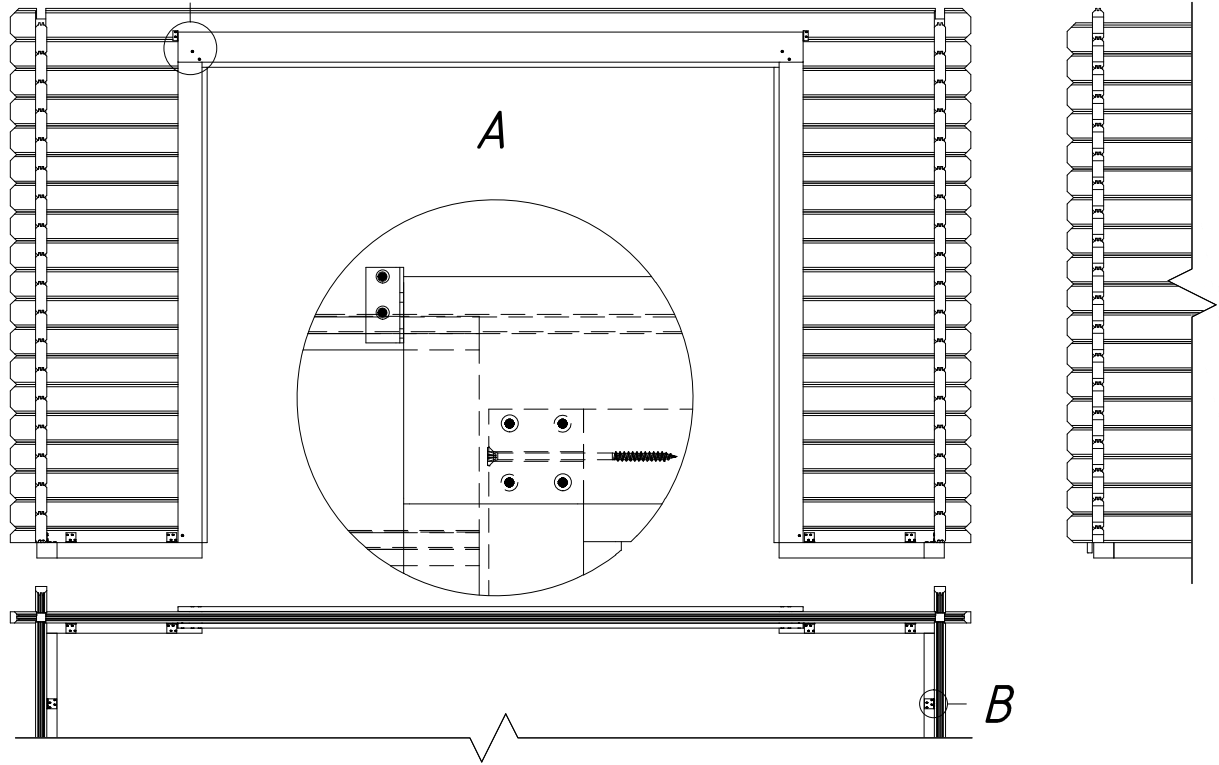
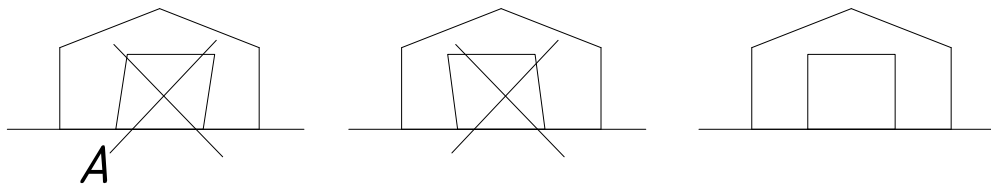

Pos	SPECIFICATION-STÜCKLISTE-NOMENCLATURE-ELEMENTI-ESPECIFICACIÓN "MTU00-31Y"	Pcs	Profile (mm)	Length (mm)
TU00-31Y	Door - Tür - Porte - Porta-Puerta 2250x2000	1		
QPL100x360x23	Detail- Detail- Detail- Dettaglio- Detalle	1	23x100	360
QKT5	Chain- Kette- Chaîne- Catena- Cadena	1	PRx+"TU00x"	3000
Fim	-Fixing kit- Befestigungsset- Moyens de fixation- Materiale di fissaggio- Kit de fijación	1		
QKRKK 8x30Zn	Bolt -Schloss-schraube -Boulon- Bullone- Perno- 8x30mm DIN 571	10		
QKRKK 8x50Zn	Bolt -Schloss-schraube -Boulon- Bullone- Perno- 8x50mm DIN 571	15		
QPOKK 8x20Zn	Bolt -Schloss-schraube -Boulon- Bullone- Perno- M8x20mm DIN 933	14		
QPOKK 8x80Zn	Bolt -Schloss-schraube -Boulon- Bullone- Perno- M8x80mm DIN 933	1		
QMUNY 8Zn	Nut- Schraubenmutter- Écrou- Dado- Tuerca- M8mm-DIN 985	15		
QSE 8x24Zn	Washer- Dichtscheibe- Joint- Rondella- Arandela- 8x24mm DIN9021	45		
QNU90x35x40Zn	L-iron- Winkel- Angle -Angolo- Angulo 90x35x40	2		
KQ-TU00-31Y lukk	Door fittings- Türbeschlag- Ferrure- Ferramenta porta- Manilla (puerta)	1		

+

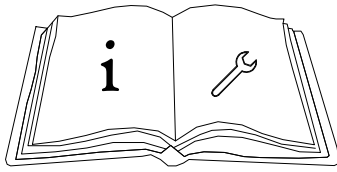

- FR44-3857-5
- FR34-3857-2
- FR44-3857-2
- FR44-4757-4
- FR70-5656-2
- FR44-5357-1
- FR44-5953-2
- FR44-4153-3

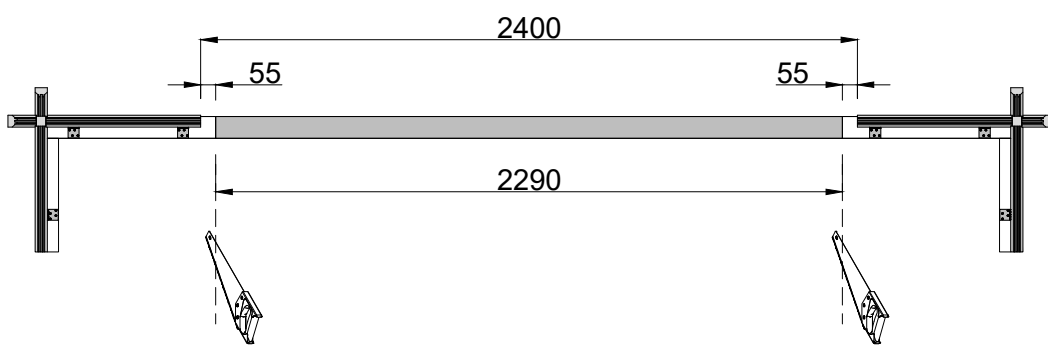
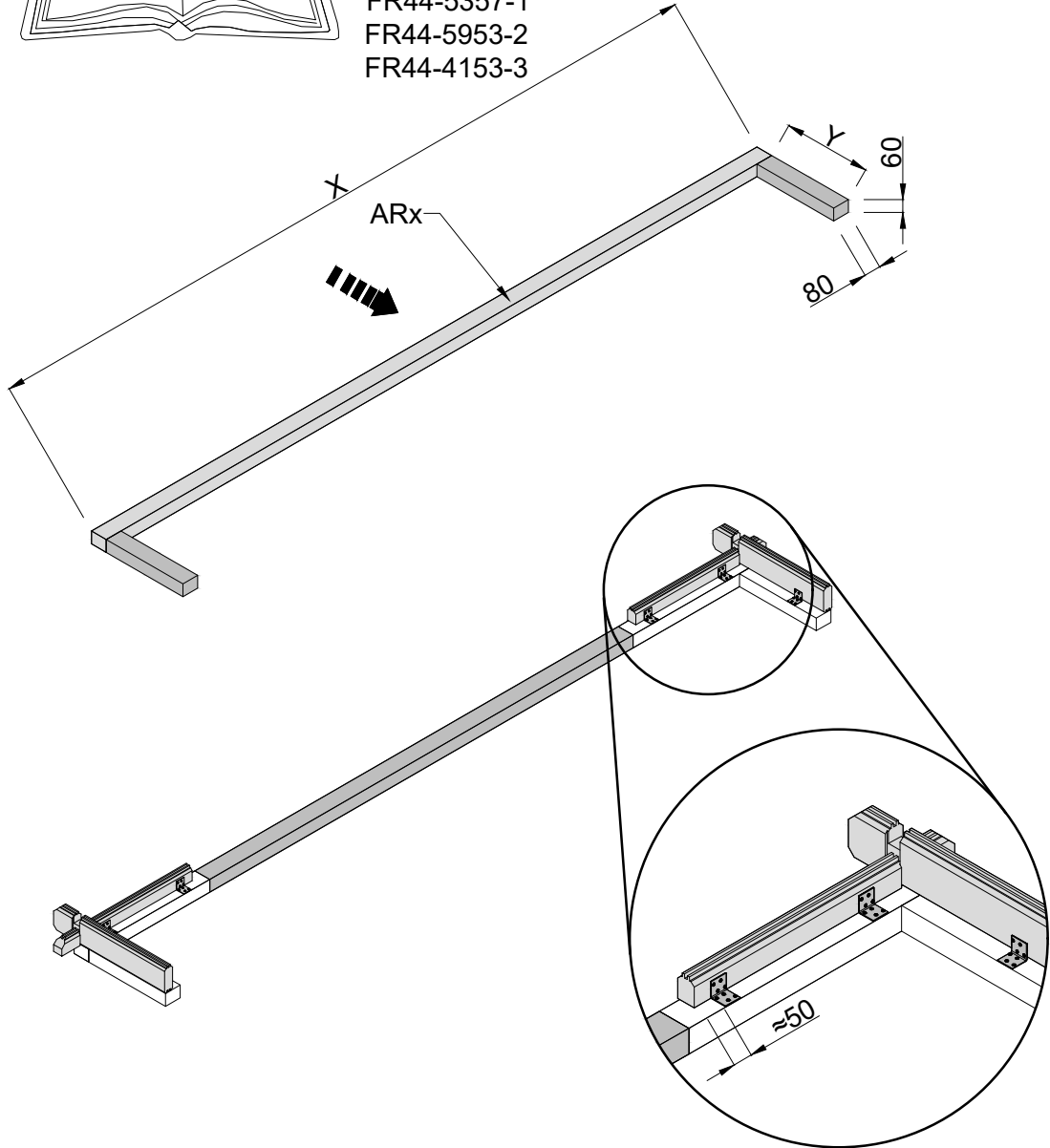

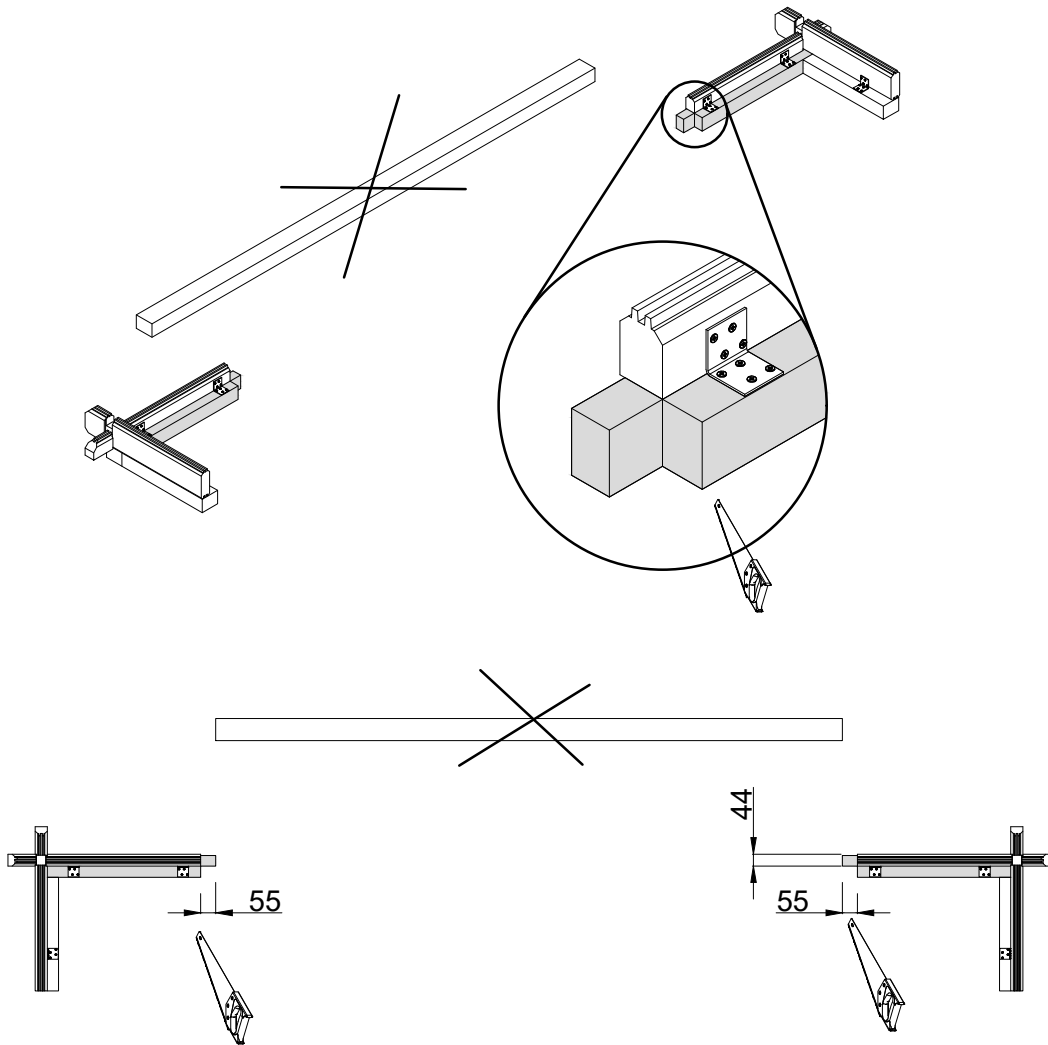

+

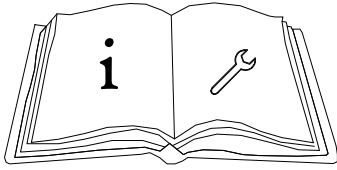

- FR44-3857-5
- FR34-3857-2
- FR44-3857-2
- FR44-4757-4
- FR70-5656-2
- FR44-5357-1
- FR44-5953-2
- FR44-4153-3

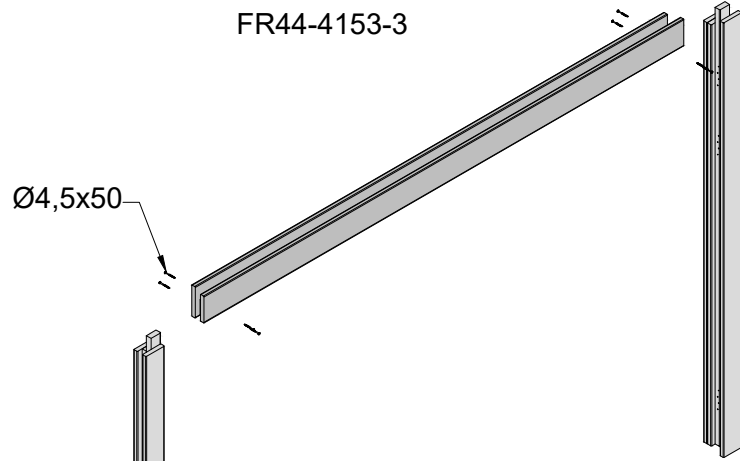

Ø4,5x50

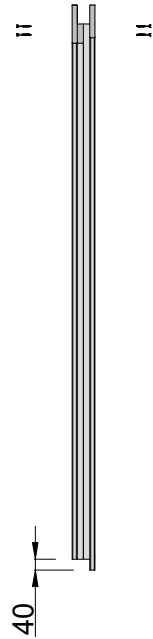

40

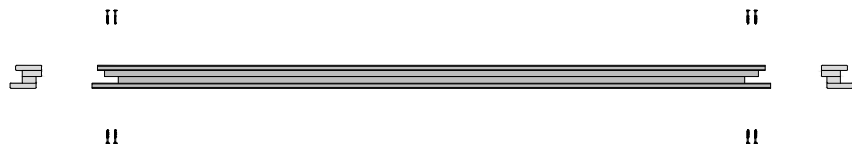

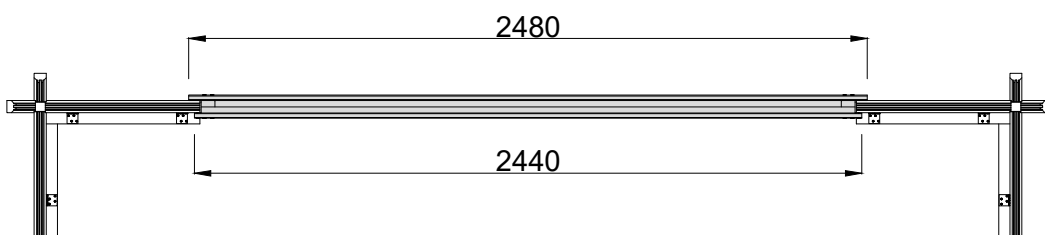
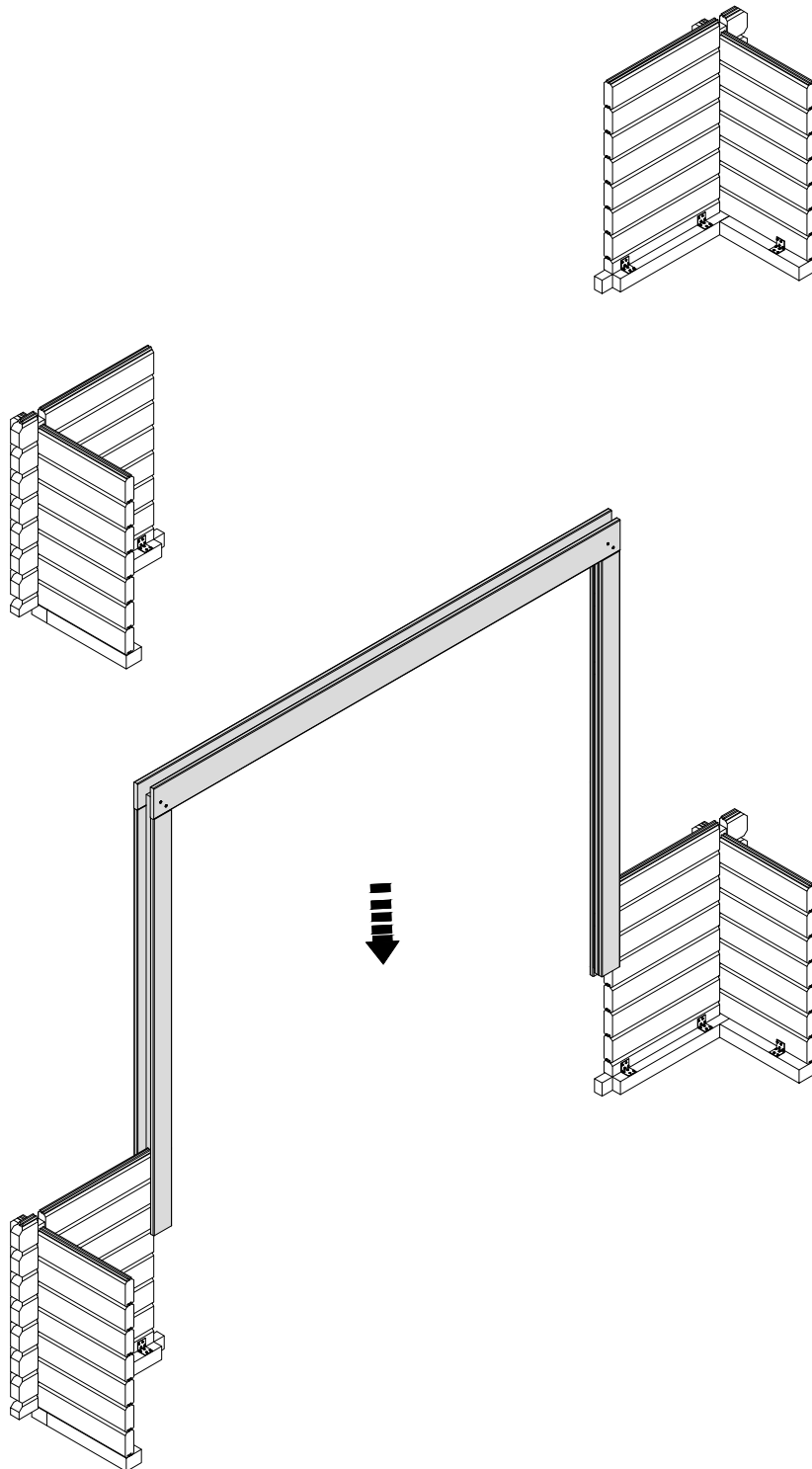

+

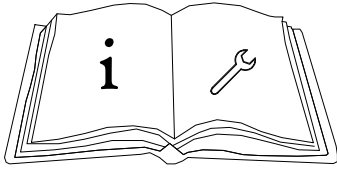

- FR44-3857-5
- FR34-3857-2
- FR44-3857-2
- FR44-4757-4
- FR70-5656-2
- FR44-5357-1
- FR44-5953-2
- FR44-4153-3

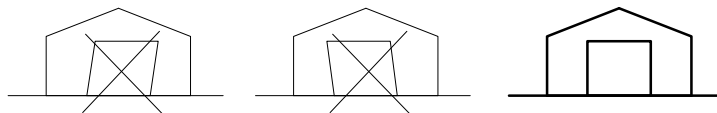
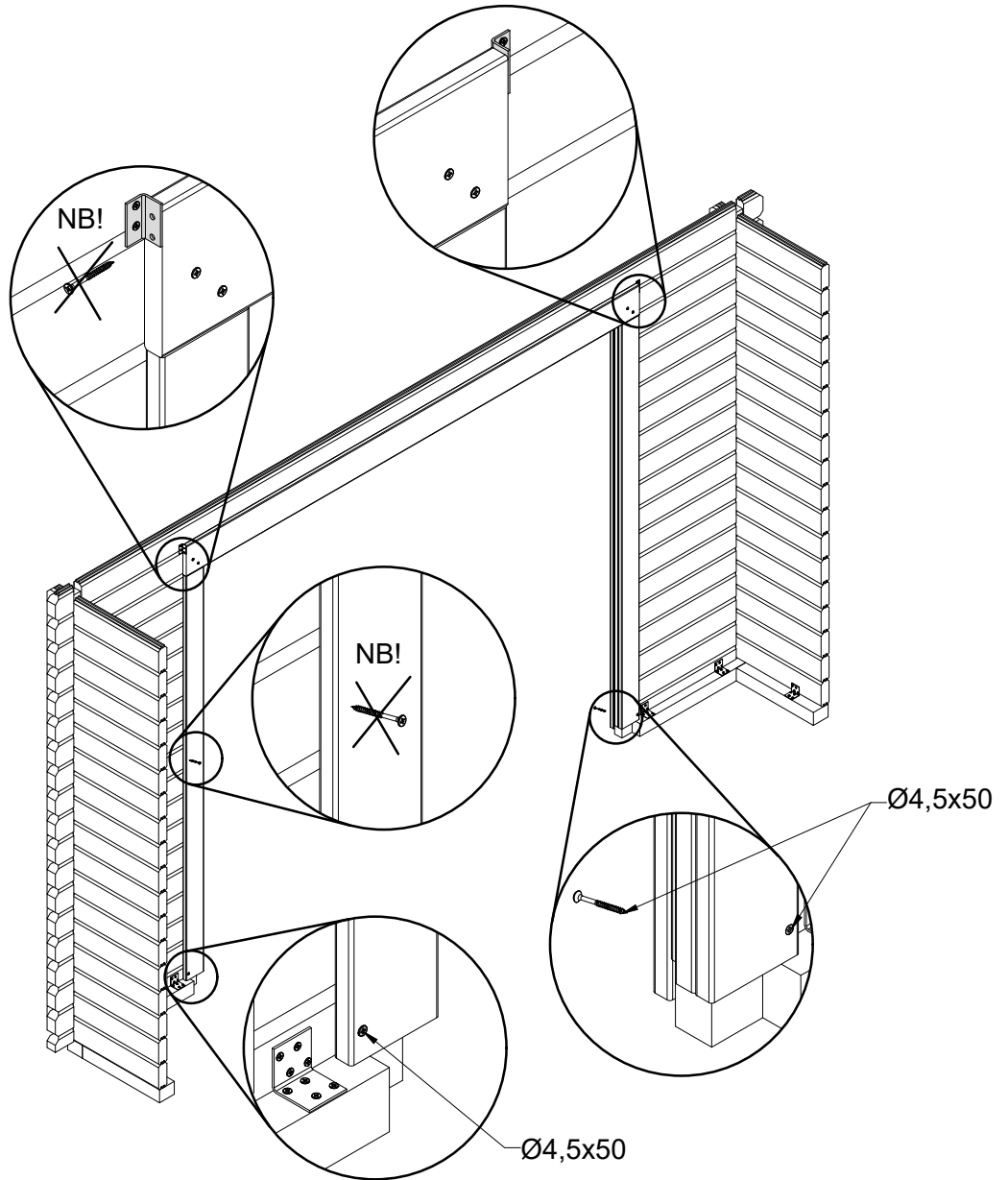

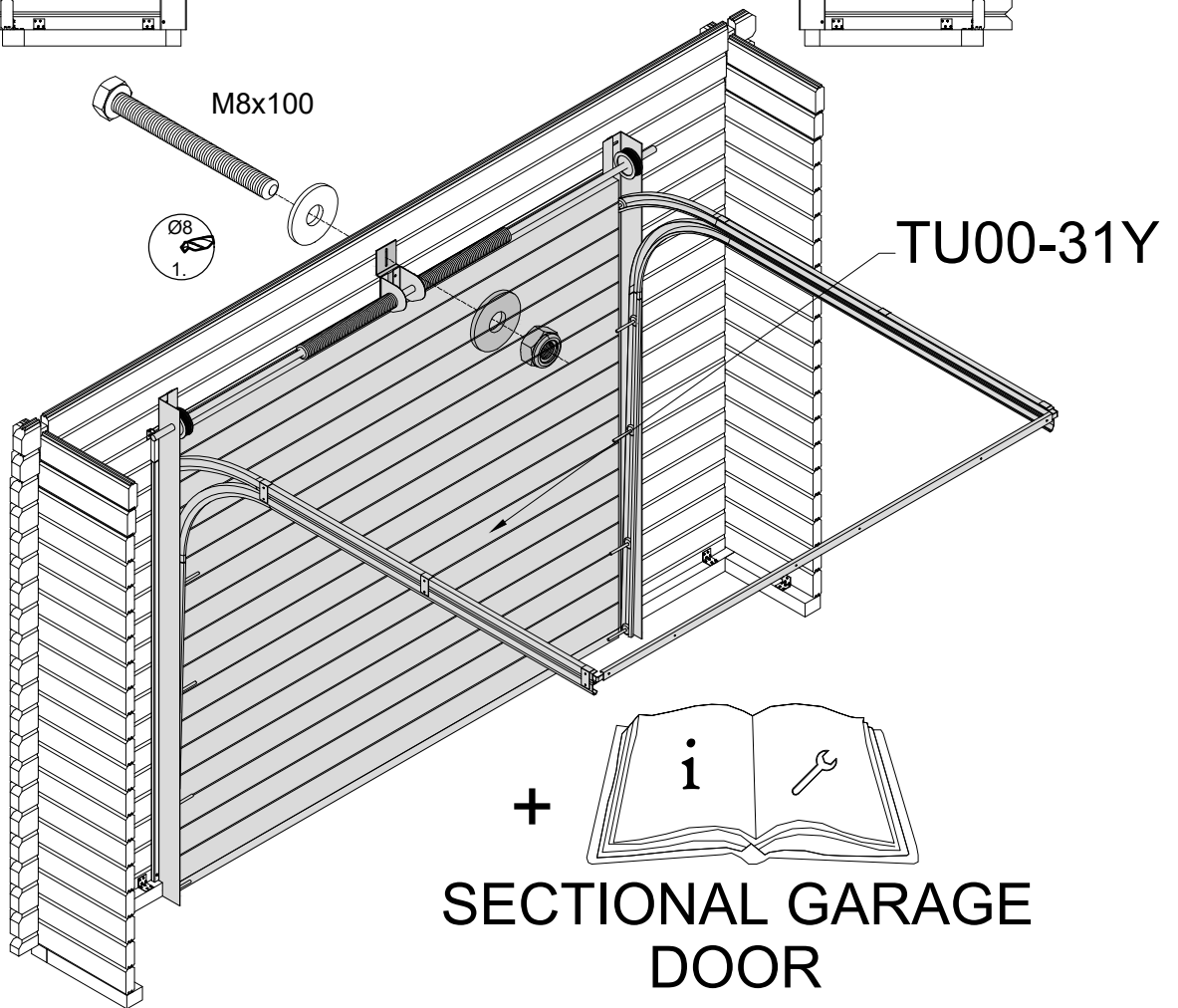
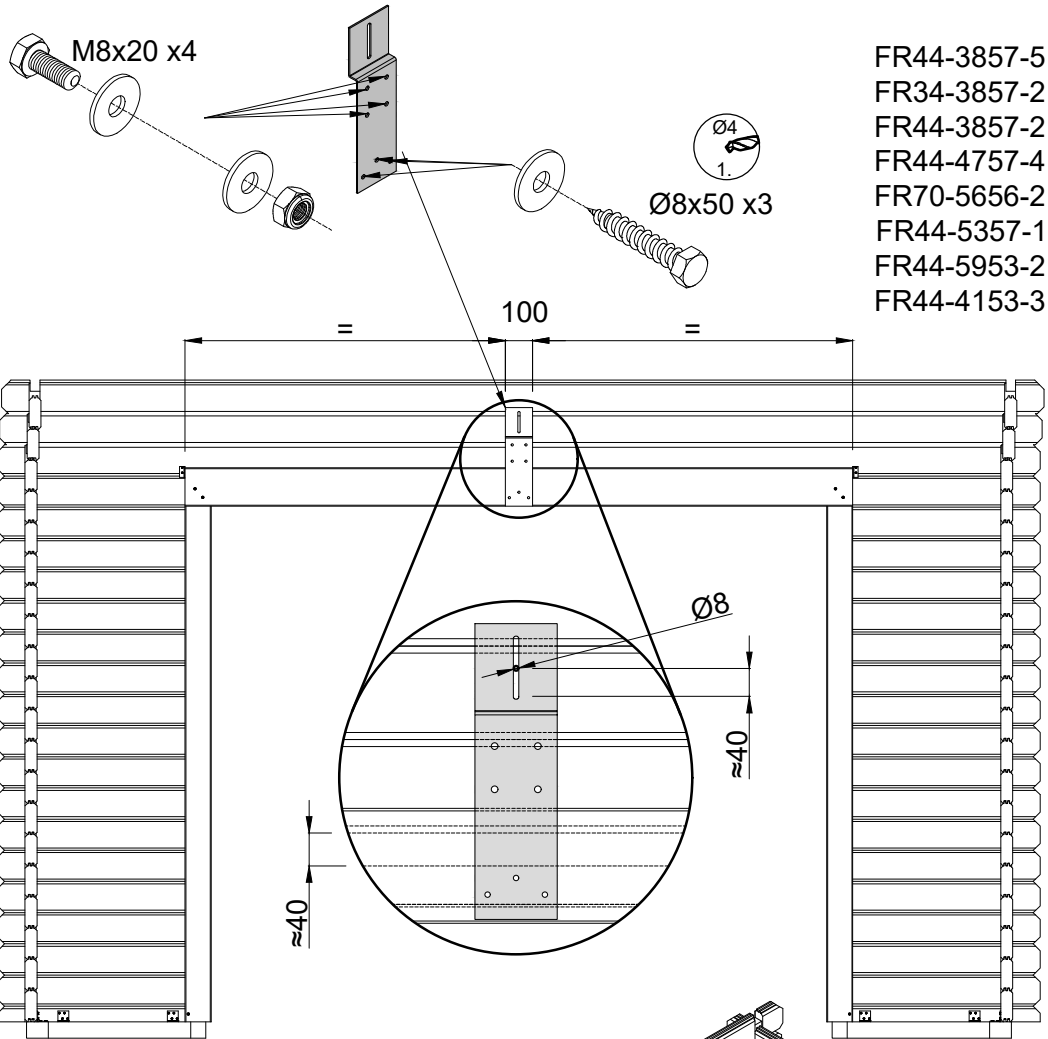

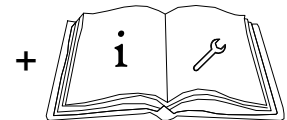
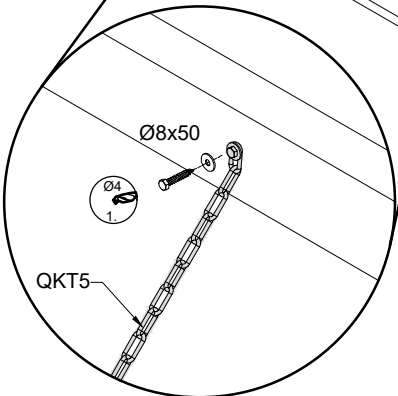
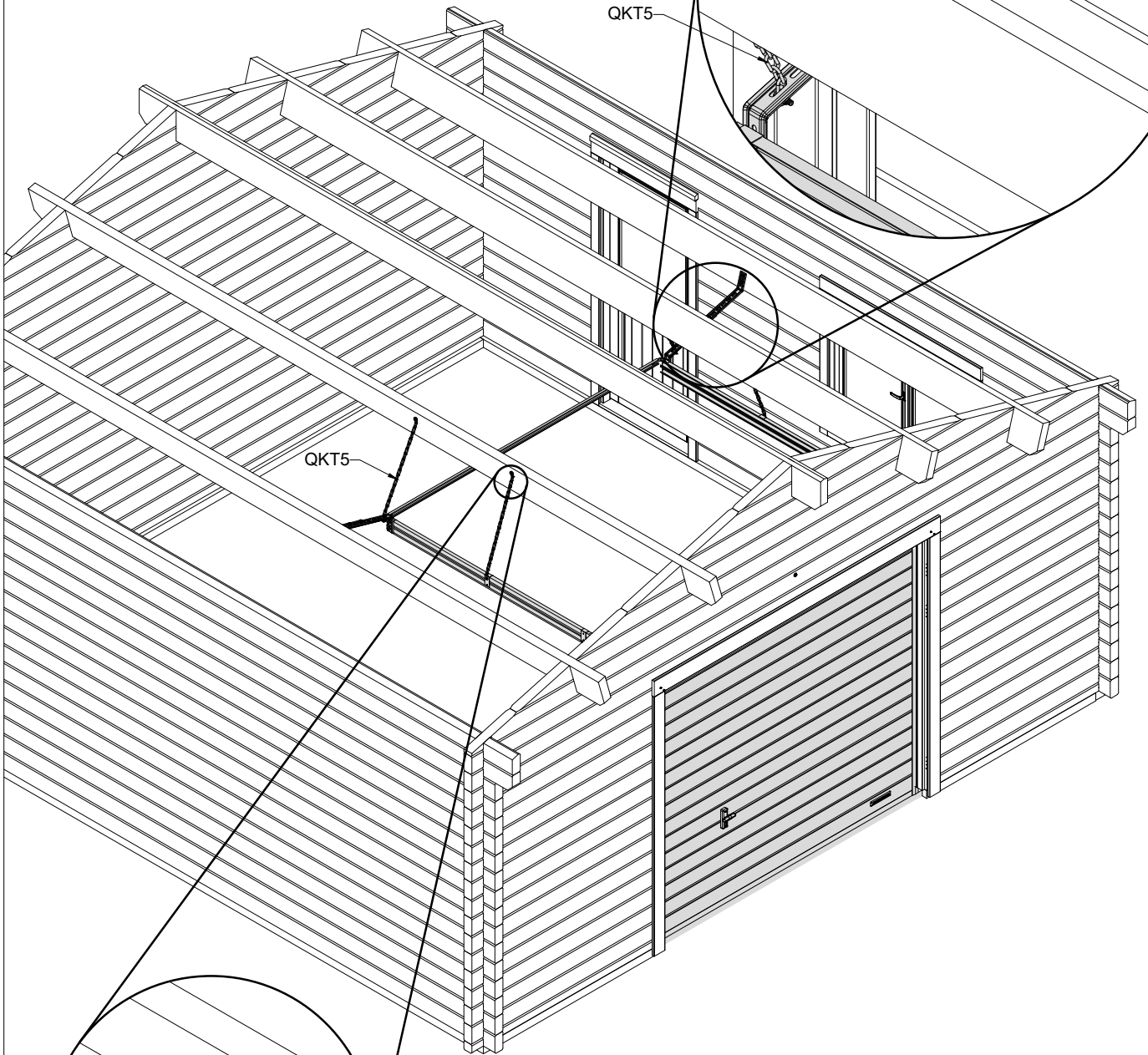
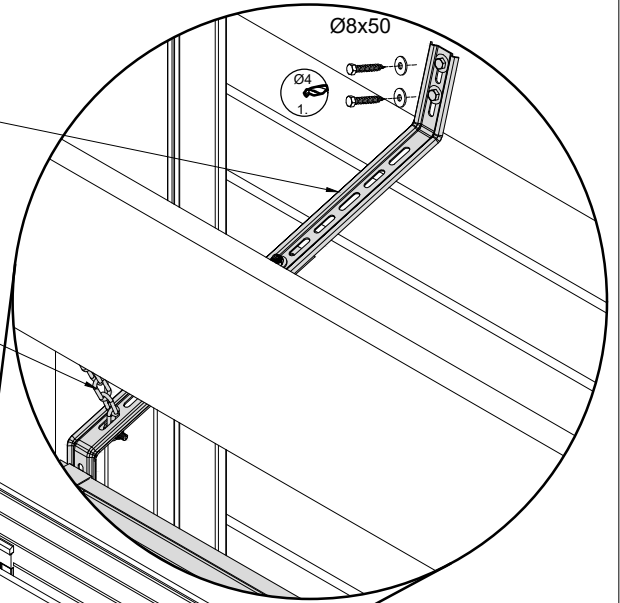
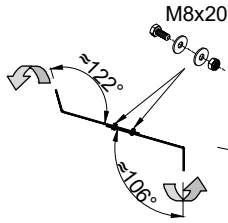
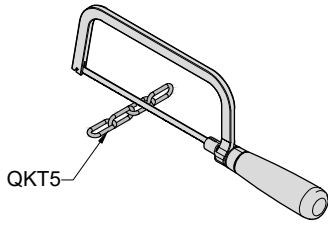

SECTIONAL GARAGE
DOOR

- ~~FR44-3857-5~~
- FR34-3857-2
- FR44-3857-2
- FR44-4757-4
- FR70-5656-2
- FR44-5357-1
- FR44-5953-2
- FR44-4153-3

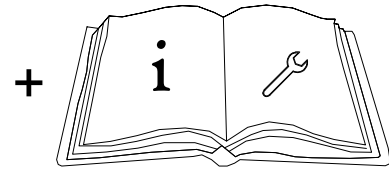
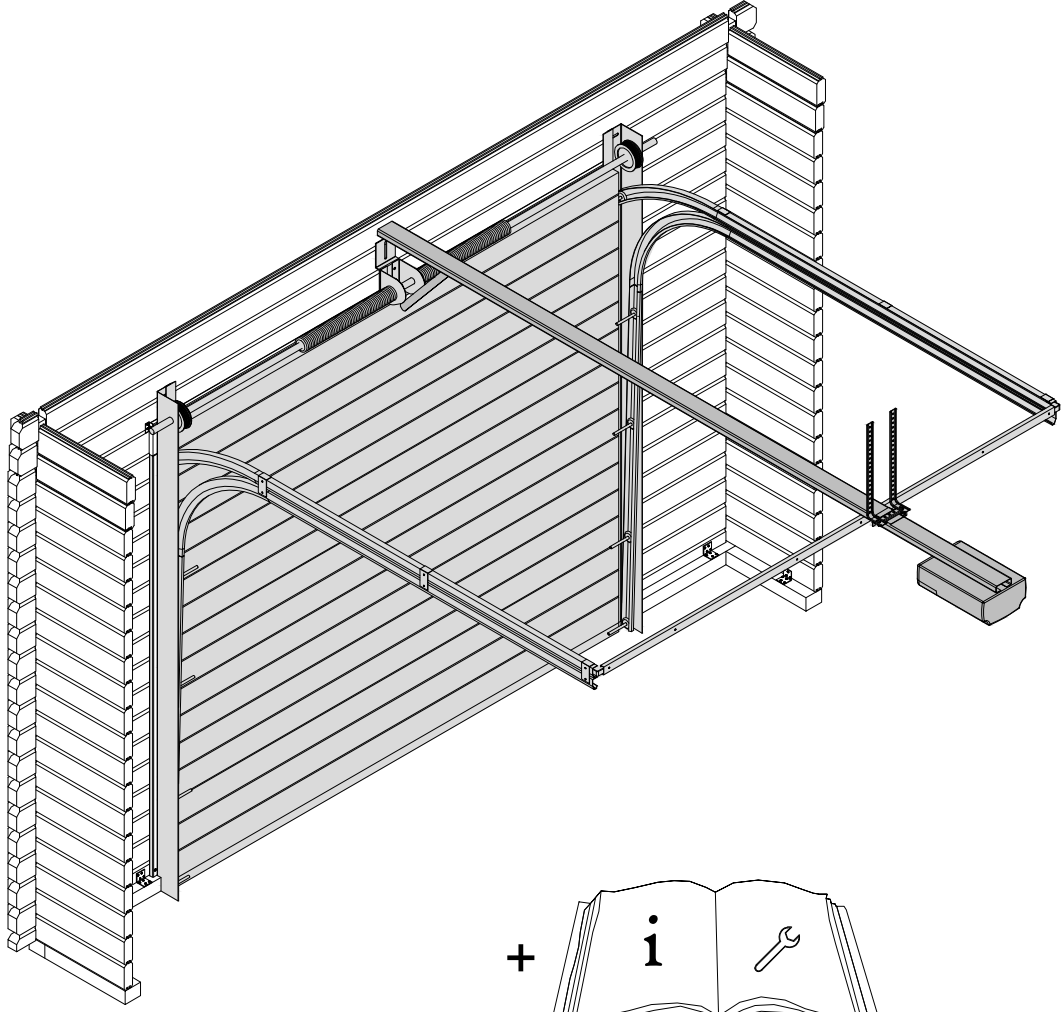

**ENGINE SECTIONAL GARAGE
DOOR***

*** OPTIONAL**

FR70-5656-2

≈50x100x600
NOT INCLUDED

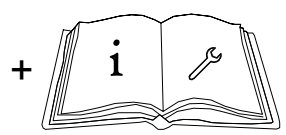
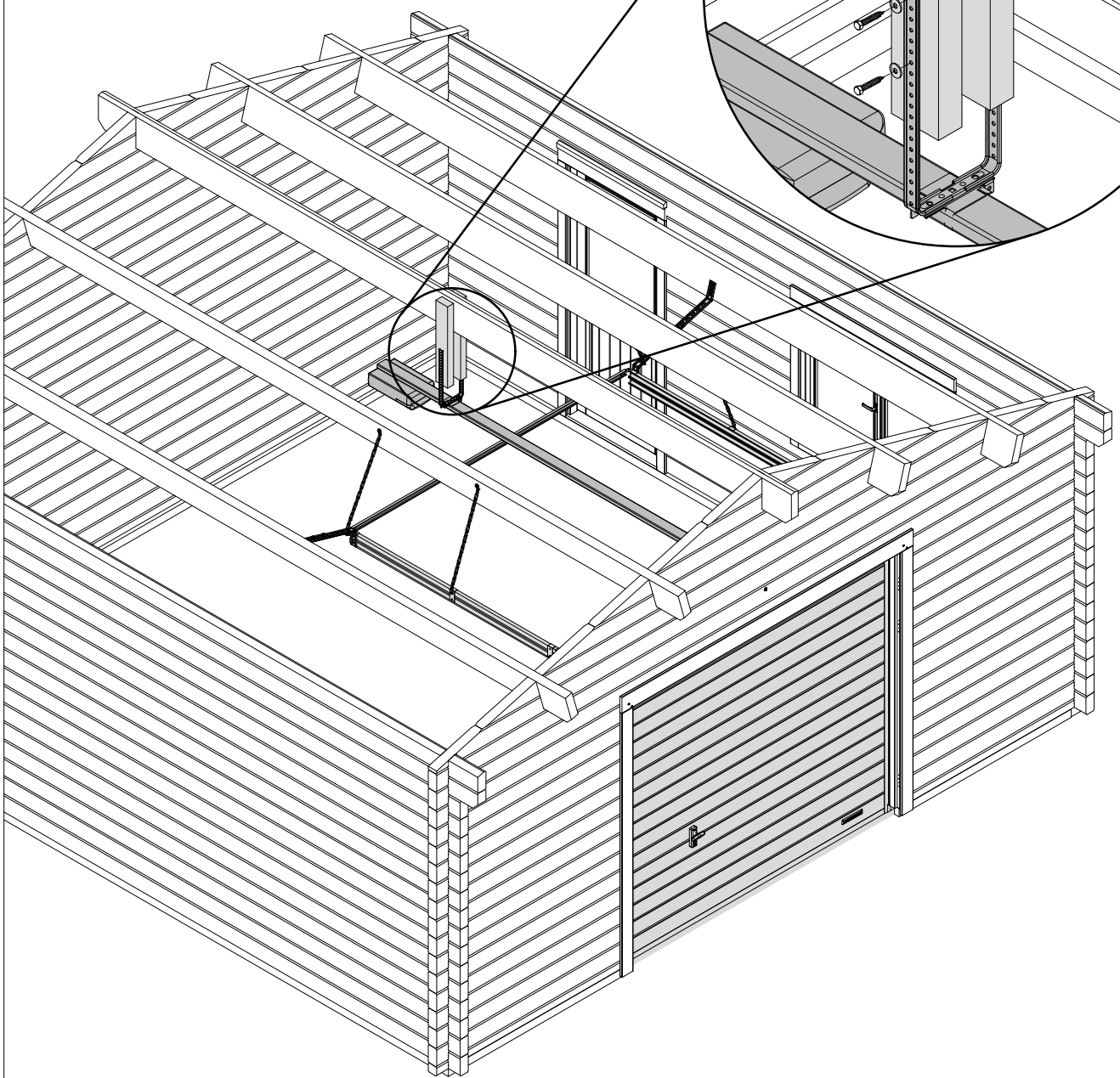
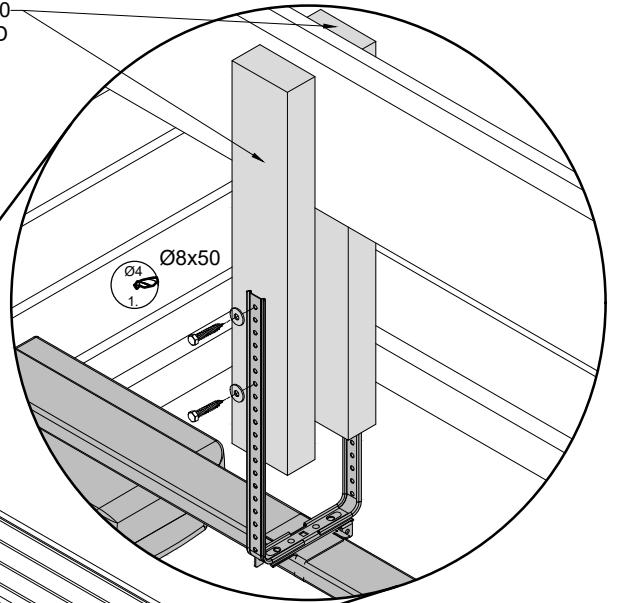

ENGINE SECTIONAL GARAGE
DOOR*

* OPTIONAL