

# Techn. Data / Daten

## Piha-Aitta 15

Log length (W x D) / Bohlenaußenmaß (B x T): 470 x 234 cm  
Wall size(outside) / Wandaußenmaß: 450 x 214 cm  
Log thickness / Bohlenstärke: 70 mm

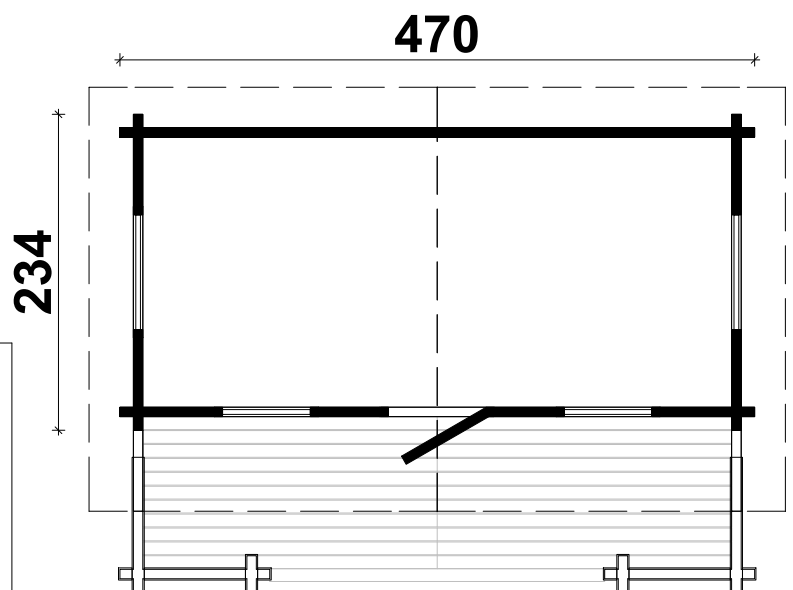

Note: All dimensions are approximate !  
Achtung : Alle angegebenen Maße sind ca. - Maße !

# Piha-Aitta 15 / 470 x 234 cm - 70 mm

## Foundation / Fundament

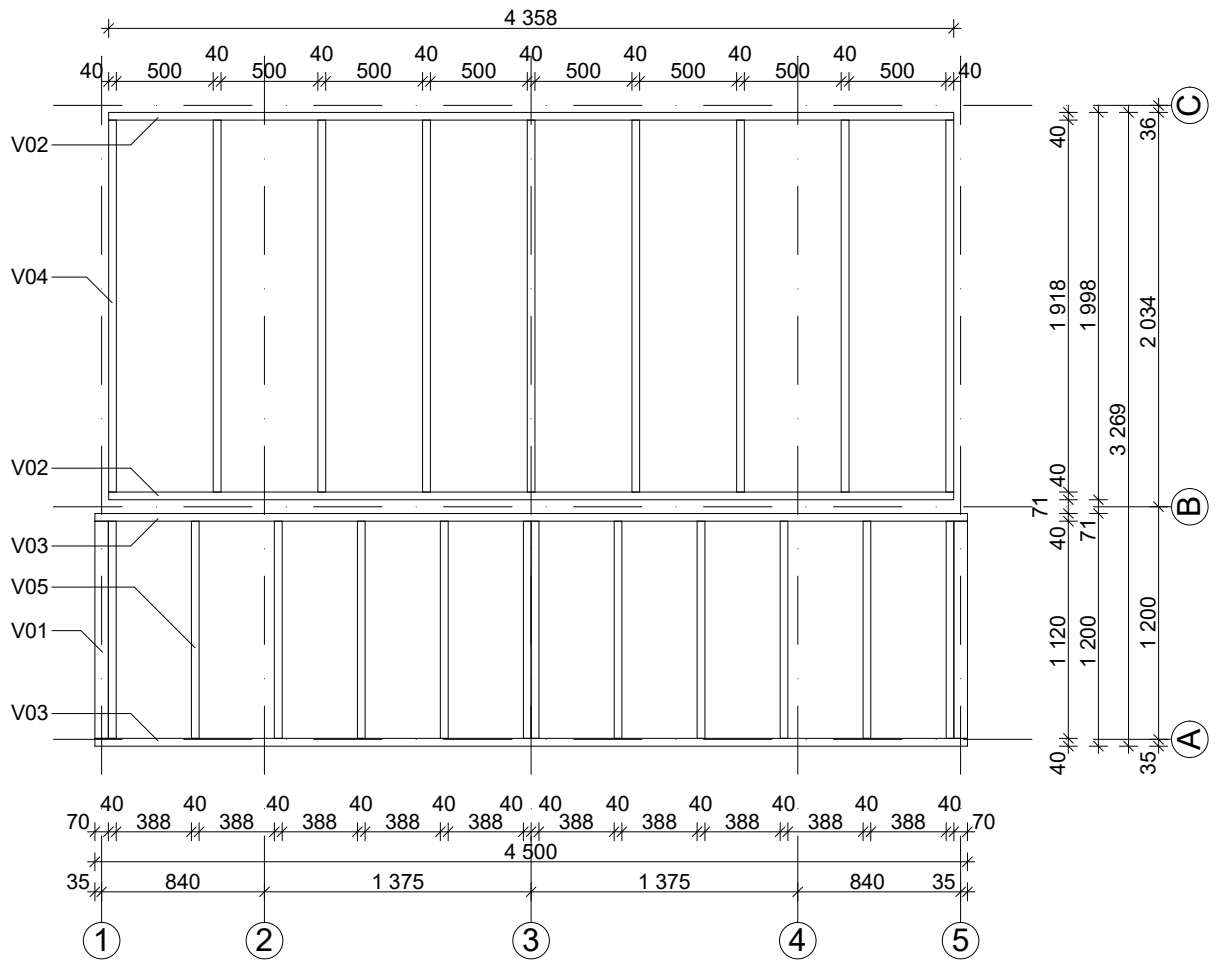

# Piha-Aitta 15 / 470 x 234 cm - 70 mm

## Ground plan / Wandplan

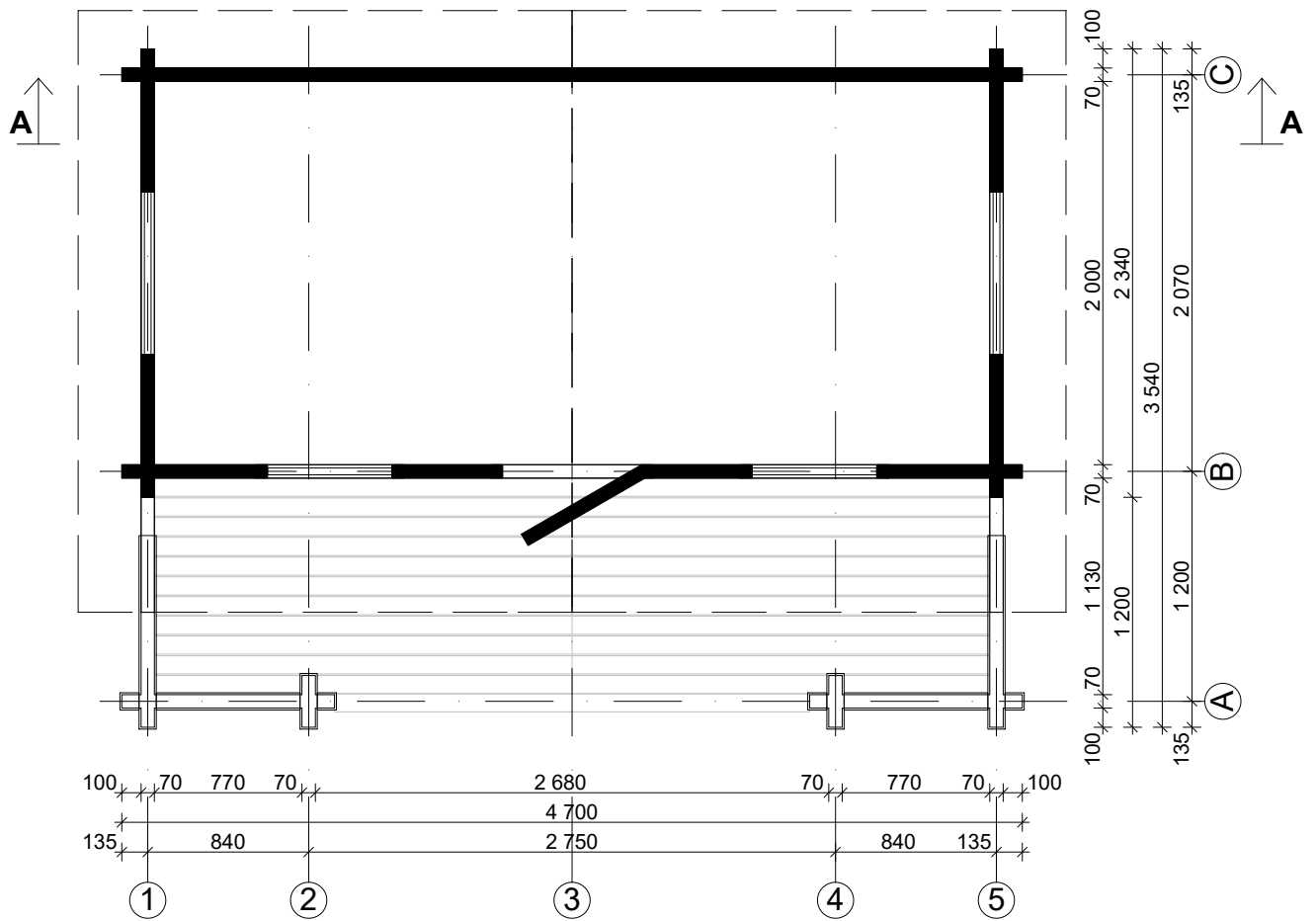

# Piha-Aitta 15 / 470 x 234 cm - 70 mm

## Roof / Dach

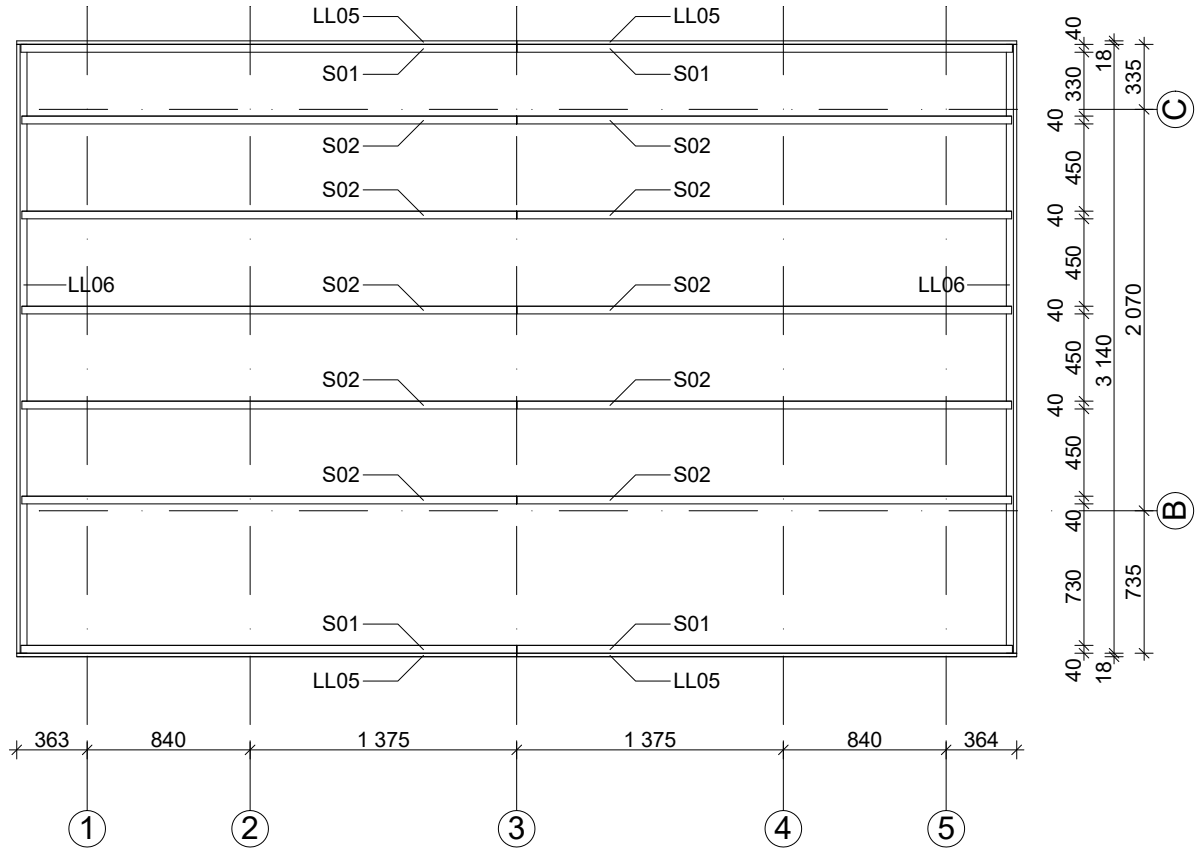

# Piha-Aitta 15 / 470 x 234 cm - 70 mm

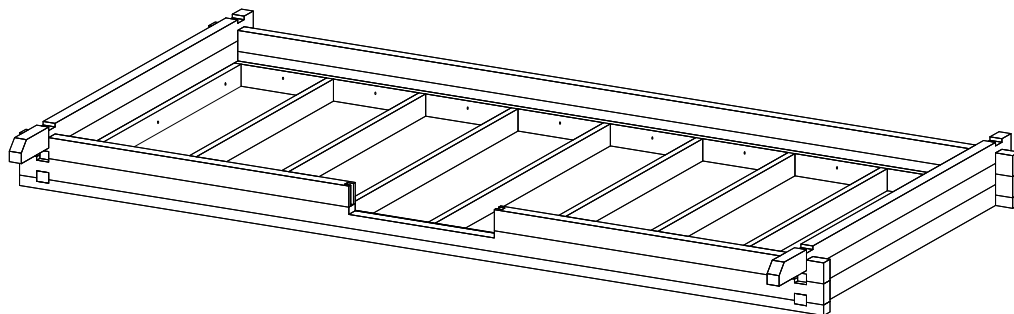
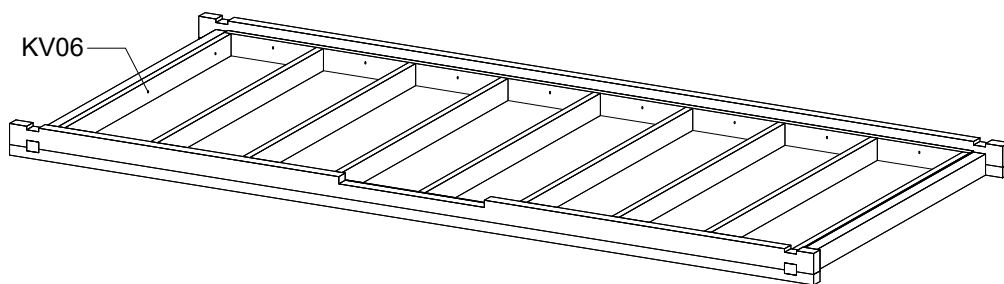
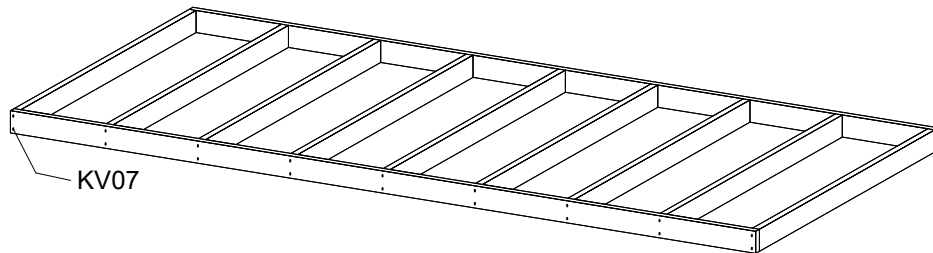

# Piha-Aitta 15 / 470 x 234 cm - 70 mm

**A**

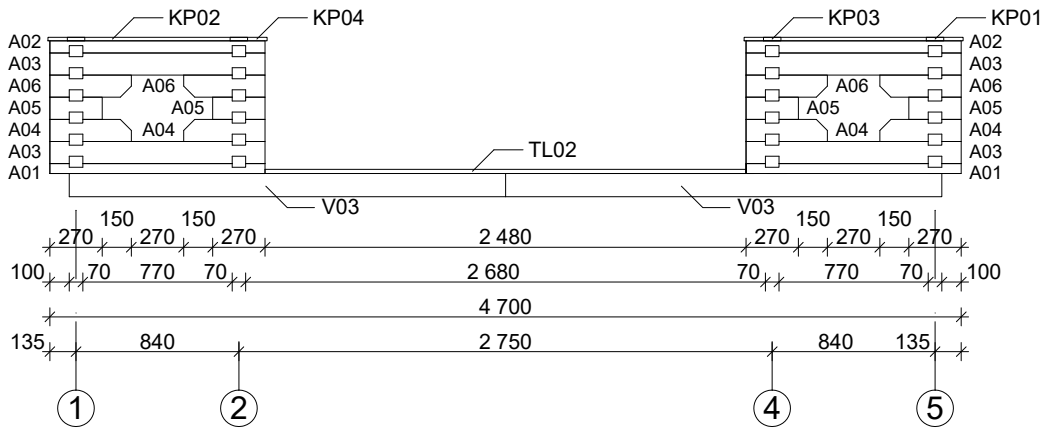

**B**

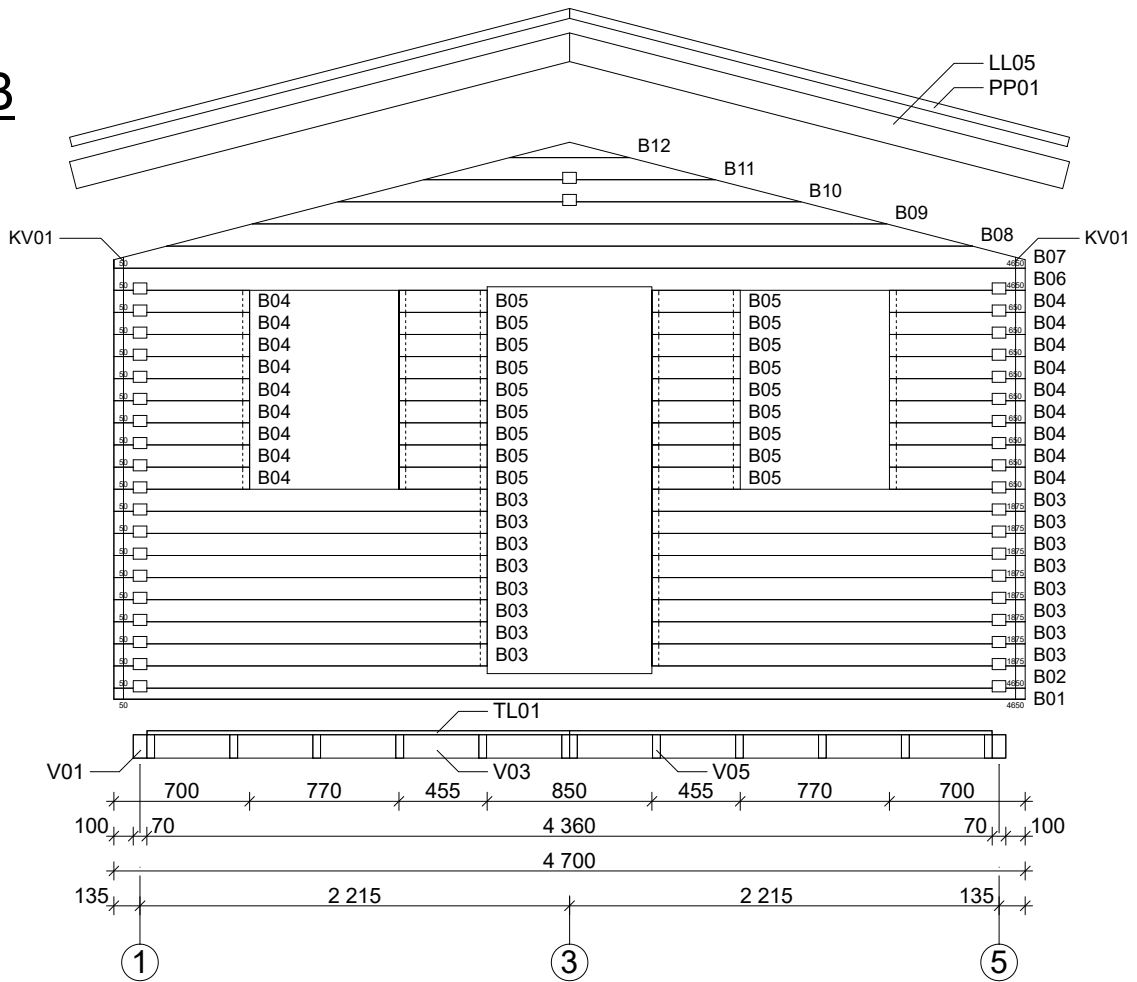

# Piha-Aitta 15 / 470 x 234 cm - 70 mm

**C**

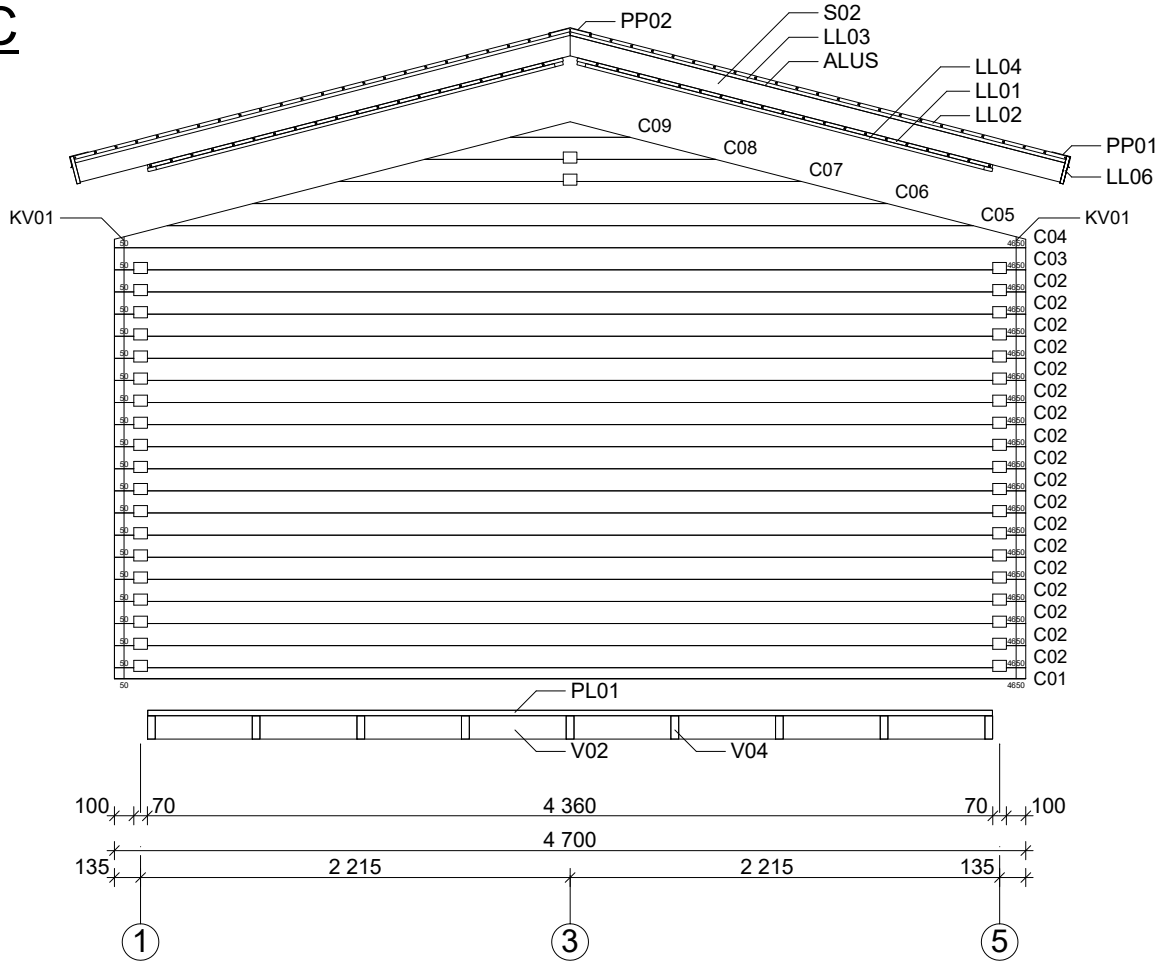

**1**

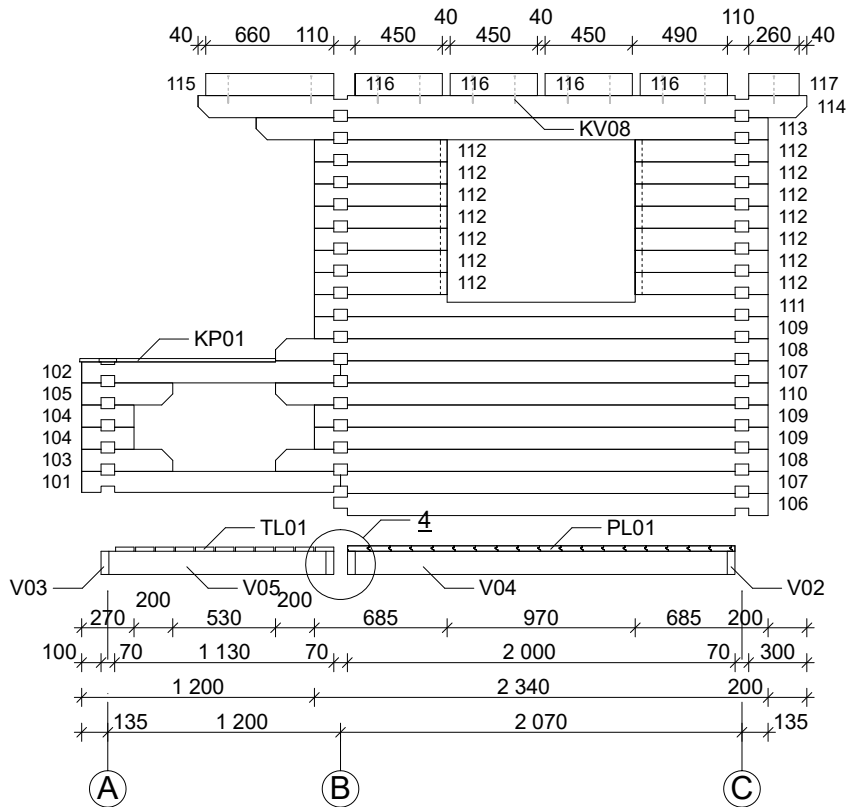

# Piha-Aitta 15 / 470 x 234 cm - 70 mm

2

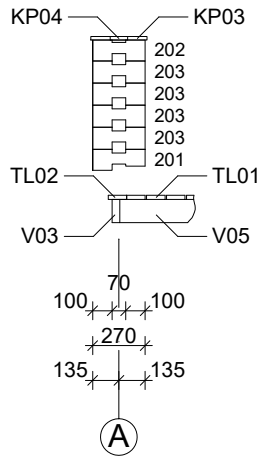

4

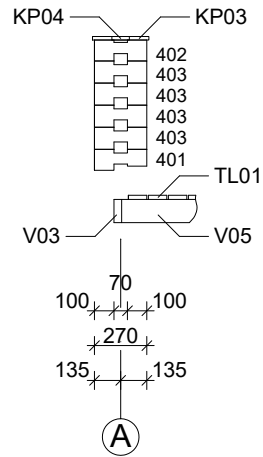

3

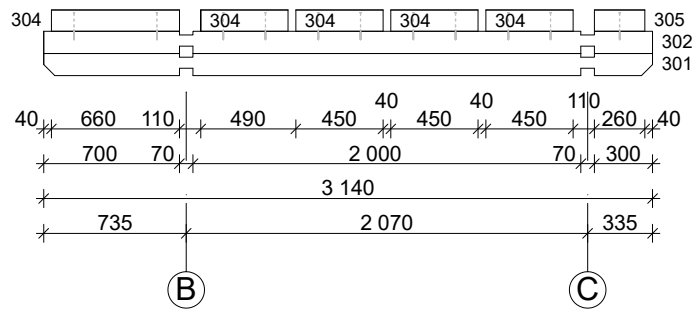

A-A

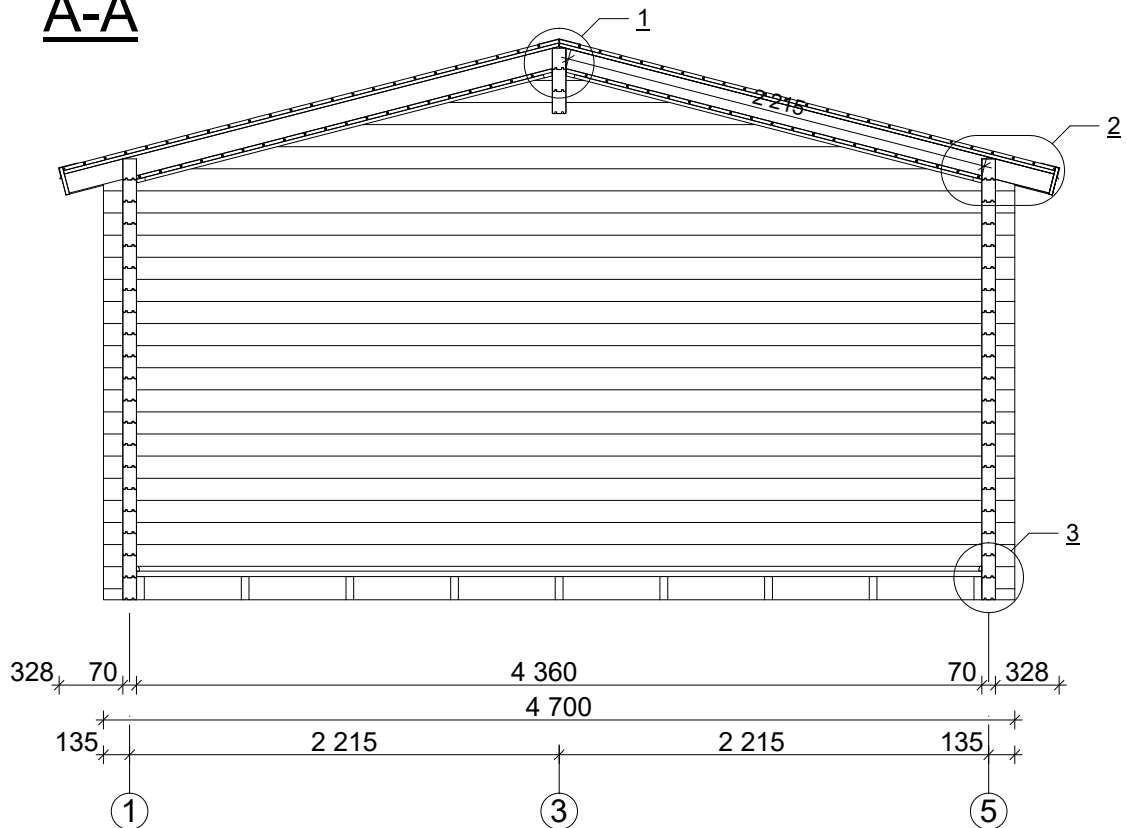



# Piha-Aitta 15 / 470 x 234 cm - 70 mm

5

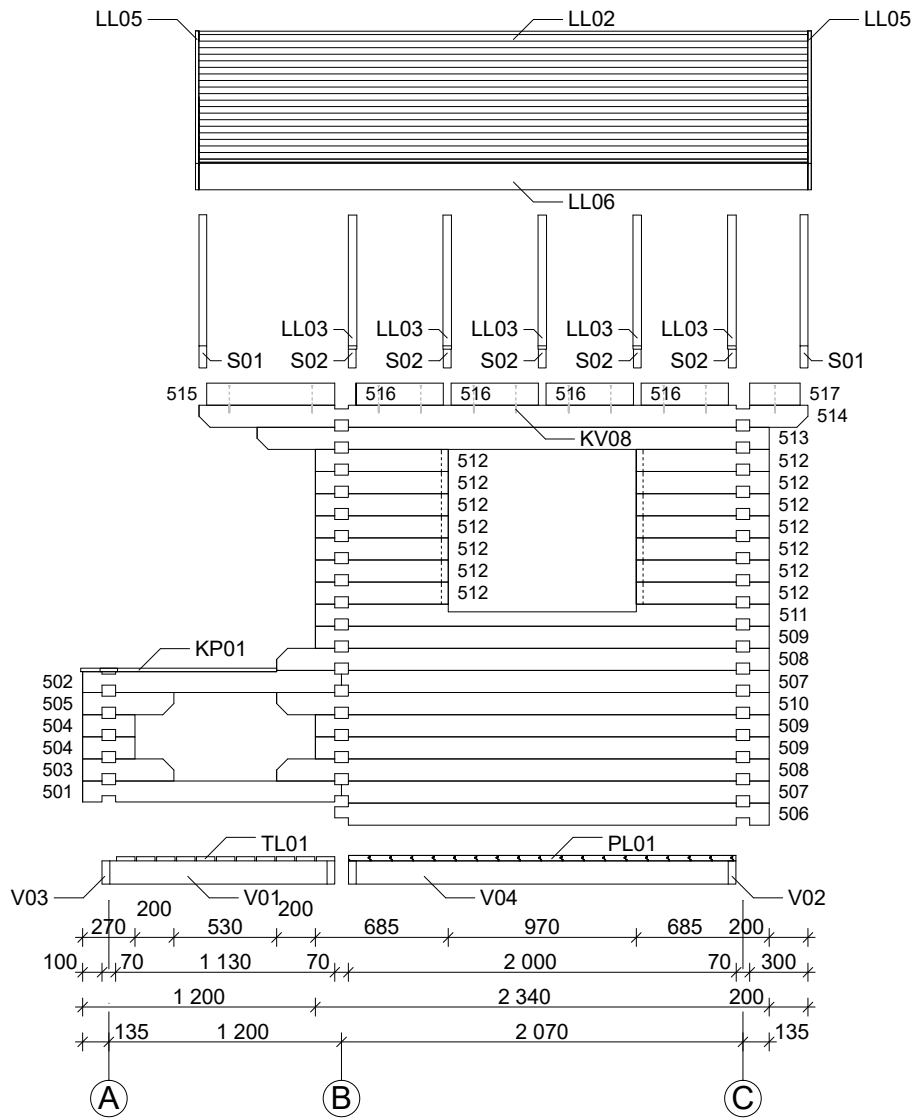

1

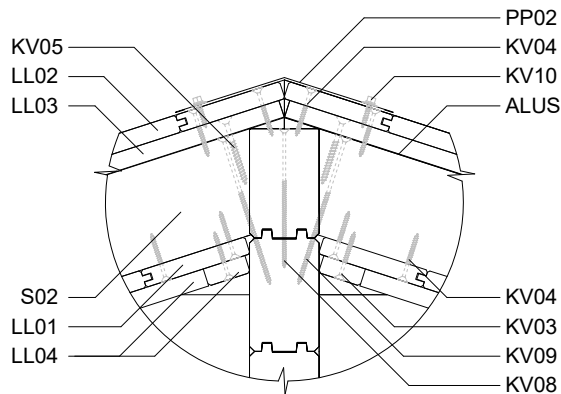

# Piha-Aitta 15 / 470 x 234 cm - 70 mm

2

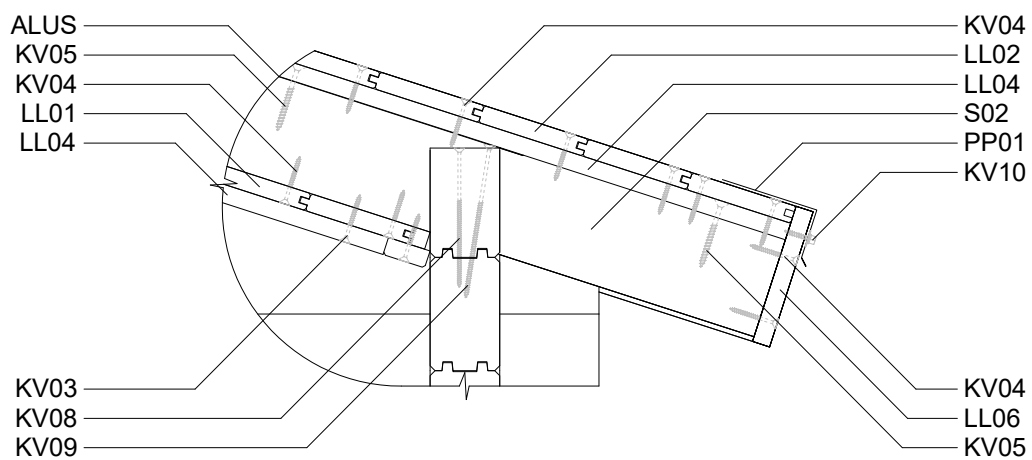



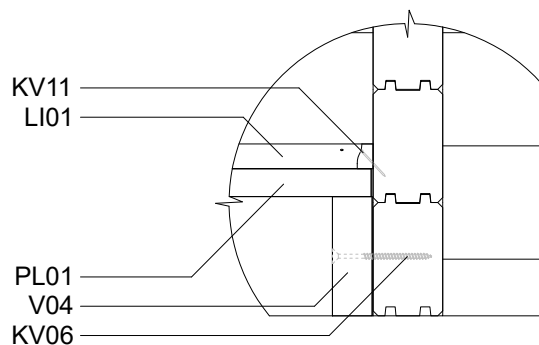



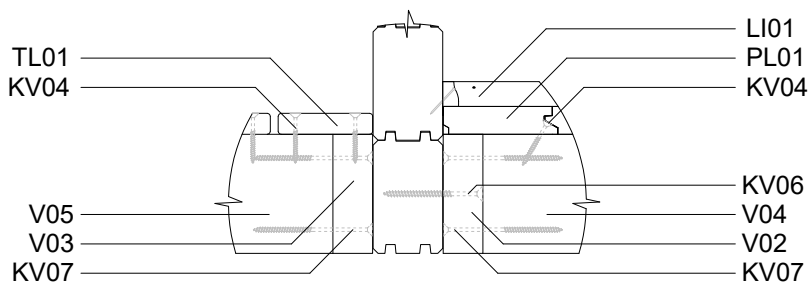







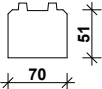
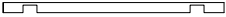
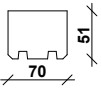

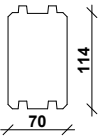

3

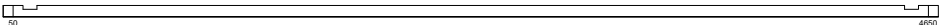
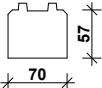

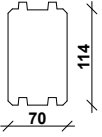









4



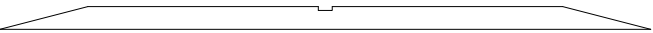
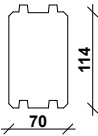

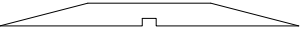
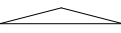
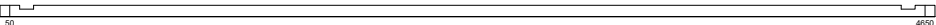
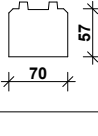

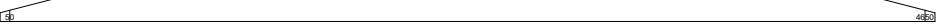
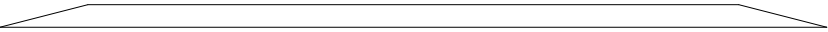

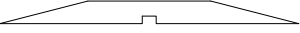
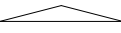







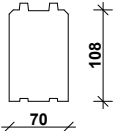

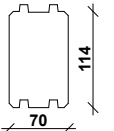

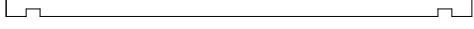
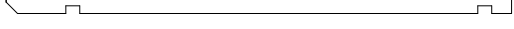

# Piha-Aitta 15 / 470 x 234 cm - 70 mm - A; B

| Nr.        |     |  mm |  mm |  × |
|------------|--|--|--|---|
| <b>A01</b> |     |     | 1110   | 2   |
| <b>A02</b> |     |     | 1110   | 2   |
| <b>A03</b> |     |     | 1110   | 4   |
| <b>A04</b> |     |  | 420  | 4   |
| <b>A05</b> |     |  | 270  | 4   |
| <b>A06</b> |     |  | 420  | 4   |
| <b>B01</b> |    |     | 4700   | 1   |
| <b>B02</b> |  |   | 4700   | 1   |
| <b>B03</b> |   |  | 1925   | 16  |
| <b>B04</b> |   |  | 700  | 18  |
| <b>B05</b> |   |  | 455  | 18  |
| <b>B06</b> |  |  | 4700   | 1   |
| <b>B07</b> |  | 4700   | 1  |   |
| <b>B08</b> |  | 4156   | 1  |   |





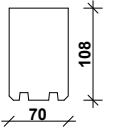









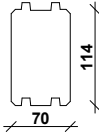

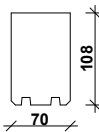

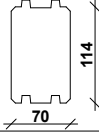
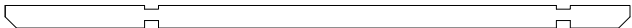
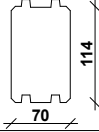
## Piha-Aitta 15 / 470 x 234 cm - 70 mm - B; C

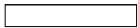
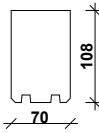
| Nr.        |    |  mm |  mm |  x |
|------------|---|--|--|---|
| <b>B09</b> |    |     | 3271   | 1   |
| <b>B10</b> |    |  | 2387   | 1   |
| <b>B11</b> |    |  | 1502   | 1   |
| <b>B12</b> |    |  | 618  | 1   |
|            |   |  |  |   |
| <b>C01</b> |   |     | 4700   | 1   |
| <b>C02</b> |   |  | 4700   | 18  |
| <b>C03</b> |   |  | 4700   | 1   |
| <b>C04</b> |   |  | 4700   | 1   |
| <b>C05</b> |   |  | 4156   | 1   |
| <b>C06</b> |  |  | 3271   | 1   |
| <b>C07</b> |  |  | 2387   | 1   |
| <b>C08</b> |  |  | 1502   | 1   |
| <b>C09</b> |  |  | 618  | 1   |
|            |   |  |  |   |
|            |   |  |  |   |
|            |   |  |  |   |



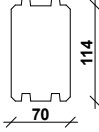

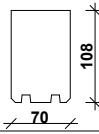

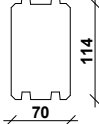



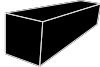

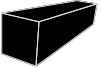

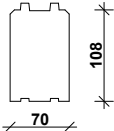

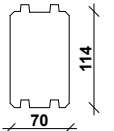
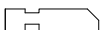

# Piha-Aitta 15 / 470 x 234 cm - 70 mm - 1

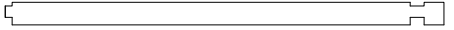
| Nr. |    |  mm |  mm |  x |
|-----|---|--|--|---|
| 101 |    |     | 1335   | 1   |
| 102 |    |     | 1335   | 1   |
| 103 |    |  | 470  | 1   |
| 104 |    |  | 270  | 2   |
| 105 |    |  | 470  | 1   |
| 106 |    |  | 2240   | 1   |
| 107 |    |  | 2205   | 2   |
| 108 |    |  | 2540   | 2   |
| 109 |    |  | 2340   | 3   |
| 110 |    |  | 2540   | 1   |
| 111 |  |  | 2340   | 1   |
| 112 |  | 685  | 14   |   |
| 113 |  | 2640   | 1  |   |
| 114 |  | 3140   | 1  |   |
| 115 |  |   | 660  | 1   |
| 116 |  |  | 450  | 4   |
| 117 |  |  | 260  | 1   |

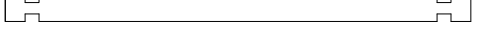
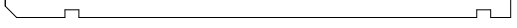
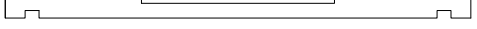



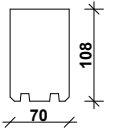









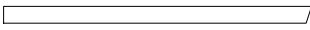
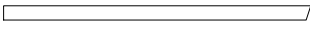

## Piha-Aitta 15 / 470 x 234 cm - 70 mm - 2; 3; 4

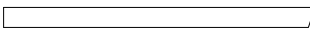
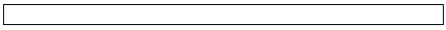
| Nr. |    |  mm |  mm |  x |
|-----|---|--|--|---|
| 201 |    |     | 270  | 1   |
| 202 |    |     | 270  | 1   |
| 203 |    |     | 270  | 4   |
| 301 |    |     | 3140   | 1   |
| 302 |    |  | 3140   | 1   |
| 303 |    |    | 660  | 1   |
| 304 |    |  | 450  | 4   |
| 305 |   |  | 260  | 1   |
| 401 |  |   | 270  | 1   |
| 402 |  |   | 270  | 1   |
| 403 |  |   | 270  | 4   |

## Piha-Aitta 15 / 470 x 234 cm - 70 mm - 5

| Nr. |    |  mm |  mm |  x |
|-----|---|--|--|---|
| 501 |    |     | 1335   | 1   |
| 502 |    |     | 1335   | 1   |
| 503 |    |  | 470  | 1   |
| 504 |    |  | 270  | 2   |
| 505 |    |  | 470  | 1   |
| 506 |    |  | 2240   | 1   |
| 507 |    |  | 2205   | 2   |
| 508 |    |  | 2540   | 2   |
| 509 |    |  | 2340   | 3   |
| 510 |    |  | 2540   | 1   |
| 511 |  |  | 2340   | 1   |
| 512 |  | 685  | 14   |   |
| 513 |  | 2640   | 1  |   |
| 514 |  | 3140   | 1  |   |
| 515 |  |   | 660  | 1   |
| 516 |  |  | 450  | 4   |
| 517 |  |  | 260  | 1   |

## Piha-Aitta 15 / 470 x 234 cm - 70 mm - Specification / Teileliste

| Nr.   |                                |  mm |  mm |  x |
|-------|---|--|--|---|
| V01   | Foundation beams / Fundamenthölzer  | 70 x 120   | 1120   | 2   |
| V02   |   | 40 x 120   | 4358   | 2   |
| V03   |   |  | 2250   | 4   |
| V04   |   |  | 1918   | 9   |
| V05   |   |  | 1120   | 12  |
| TL01  | Terrace board / Terrassendielen   |     | 2179   | 22  |
| TL02  |   |  | 2479   | 1   |
| PL01  | Floor boards / Fußbodenbretter  |     | 4356   | 19+1  |
| S01   | Rafter / Dachsparren           | 40x120   | 2640   | 4   |
| S02   |                                | 40x102   | 2635   | 10  |
| LL01  | Ceiling boards / Deckenbretter  |     | 1996   | 42  |
| LL02  | Roof boards / Dachbretter   |  | 3140   | 48+2  |
| LL03  | Trim / Leiste   | 18x44  | 2635   | 10  |
| LL04* |   |  | ca. 17,0 m   |   |
| LL05  | Fascia board / Giebelblende    | 18x143   | 2665   | 4   |
| LL06  | Eave edging / Traufenbrett     |  | 3140   | 2   |
| LI01  | Baseboard / Fußleisten      |  | ca. 12,8 m   |   |
| KP01  | Handrail / Terrassenabschlußbrett   | 18x90  | 1010   | 2   |
| KP02  |                              |  | 750  | 2   |
| KP03  |   |  | 290  | 2   |
| KP04  |   |  | 100  | 4   |
| ALUS* | Underlay / Unterlage  |   | ca. 9,2 m  |   |
| PP01* | Flashing                   |  | 2500   | 7   |
| PP02* | Flashing                   |  | 1700   | 2   |
| VR01  | Ventilation grate ø100 mm  |  |  | 1   |
| VR02  | Disc valve ø100 mm         |  |  | 1   |
| KV01  | Threaded Rod  | ∅ 10   | 2330   | 4   |
| KV02  | Nut, washer / Mutter, Scheibe   |  |  | 8   |
| KV03  | Screws / Schrauben 4,0 x 40   |  |  | 40  |
| KV04  | Screws / Schrauben 4,0 x 50   |  |  | 1150  |
| KV05  | Screws / Schrauben 5,0 x 70   |  |  | 90  |
| KV06  | Screws / Schrauben 5,0 x 100  |  |  | 70  |
| KV07  | Screws / Schrauben 5,0 x 120  |  |  | 100   |
| KV08  | Screws / Schrauben 6,0 x 140  |  |  | 40  |
| KV09  | Screws / Schrauben 6,0 x 160  |  |  | 30  |
| KV10  | Roof screw / Dachschraube   |  |  | 70  |
| KV11  | Nails / Nägel 1,4 x 35  |  |  | 50  |
| LK    | Hit block / Schlaghölzer  |  |  |   |
| KÄRG  | Roofing felt / Dachpappe  |  | roof area ca. 16,9 m <sup>2</sup>  | --  |
| VILL  | Insulation / Dämmung 50 mm  |  | ca. 8,9 m <sup>2</sup>   | --  |



