

Techn. Data / Daten

Piha-Aitta 12

Log length (W x D) / Bohlenaußenmaß (B x T): 380 x 234 cm
Wall size(outside) / Wandaußenmaß: 360 x 214 cm
Log thickness / Bohlenstärke: 70 mm

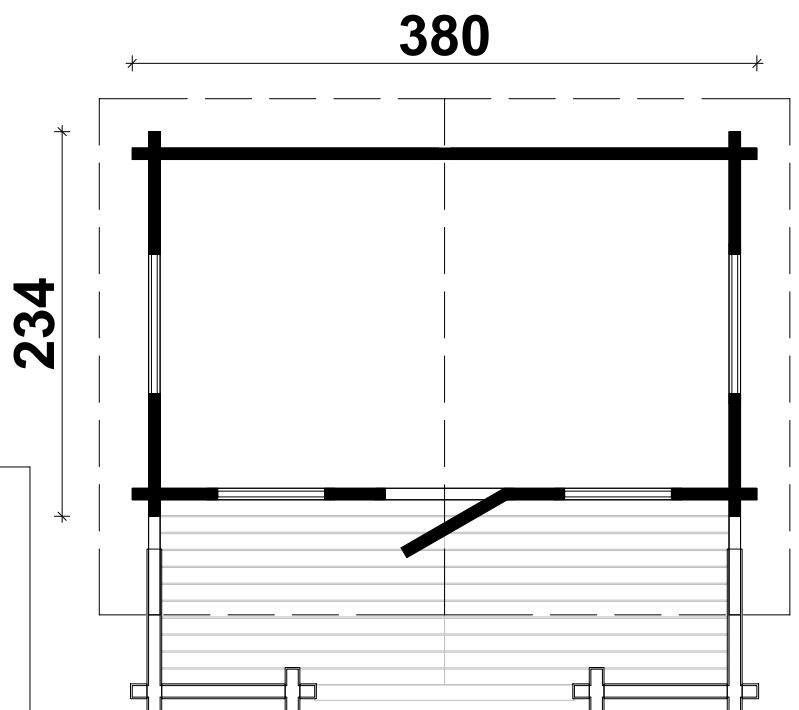

Note: All dimensions are approximate !
Achtung : Alle angegebenen Maße sind ca. - Maße !

Piha-Aitta 12 / 380 x 234 cm - 70 mm

Foundation / Fundament

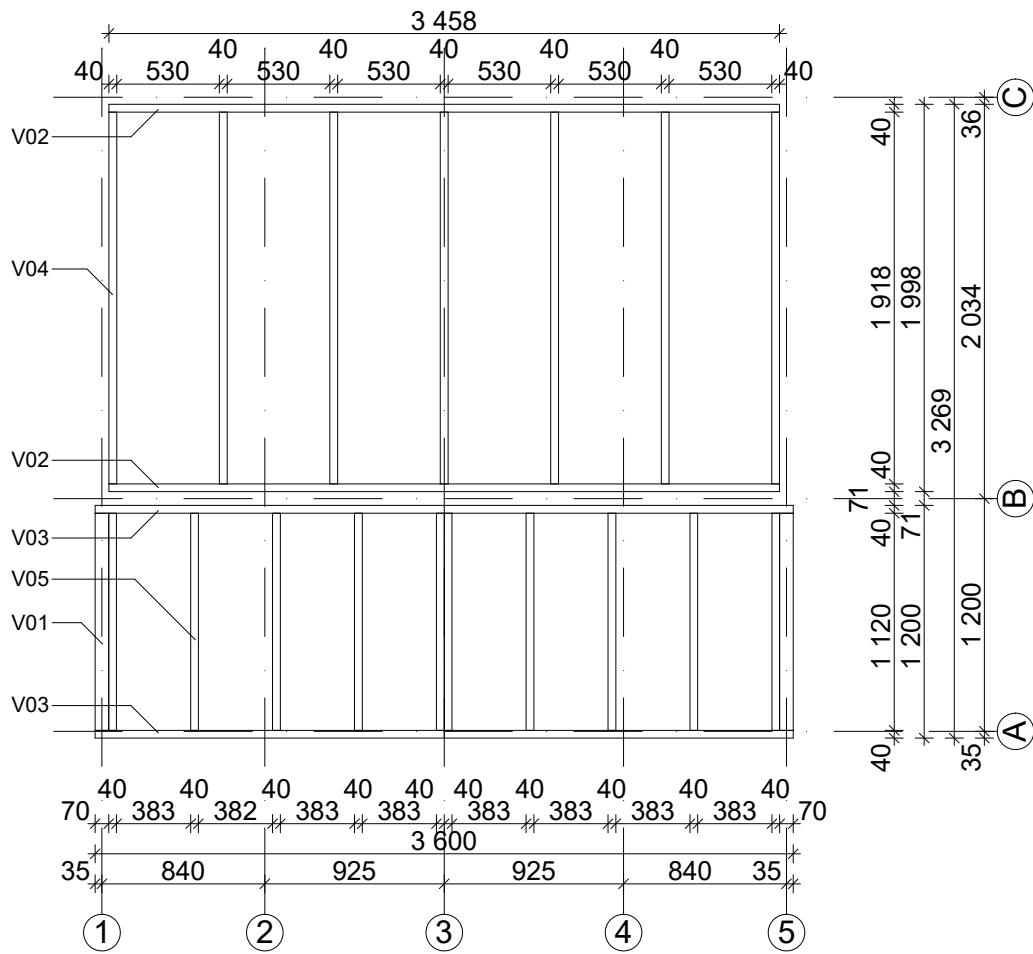

Piha-Aitta 12 / 380 x 234 cm - 70 mm

Ground plan / Wandplan

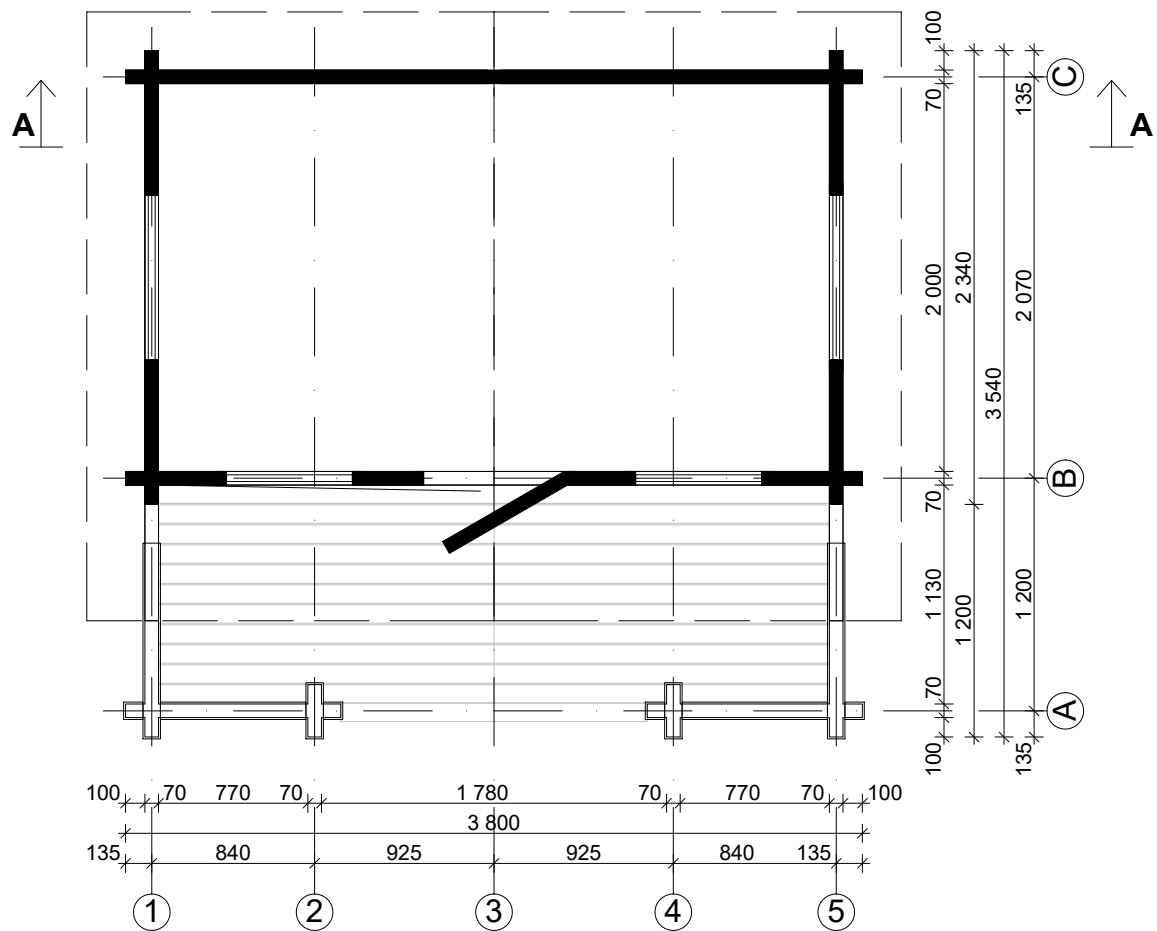

Piha-Aitta 12 / 380 x 234 cm - 70 mm

Roof / Dach

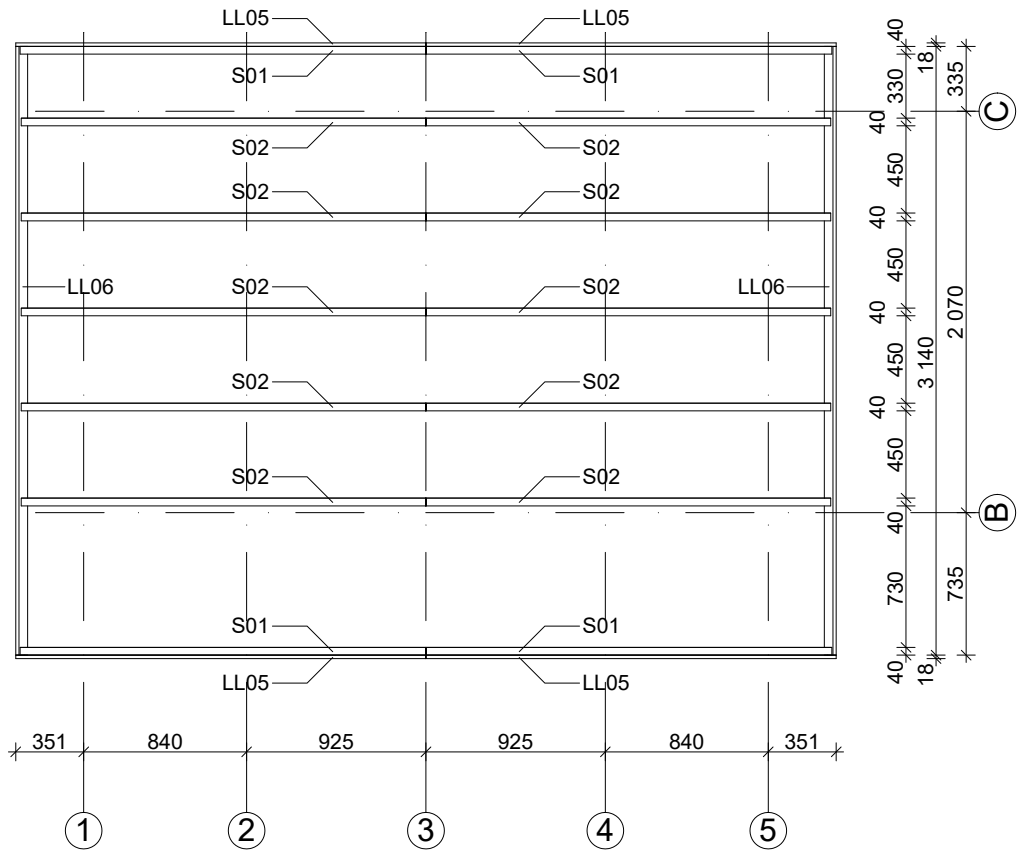

Piha-Aitta 12 / 380 x 234 cm - 70 mm

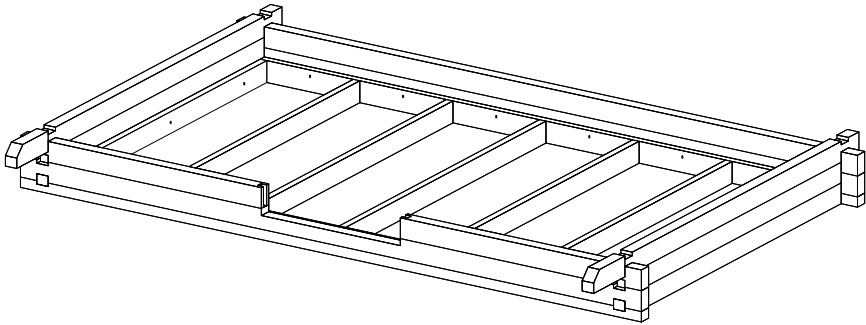
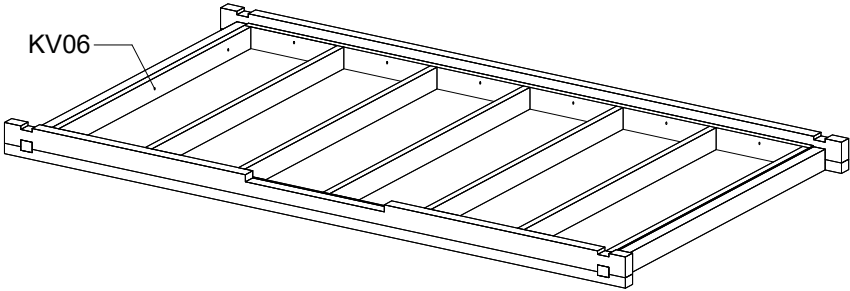
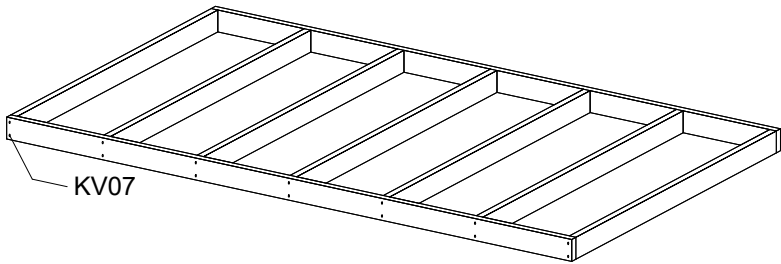

Piha-Aitta 12 / 380 x 234 cm - 70 mm

A

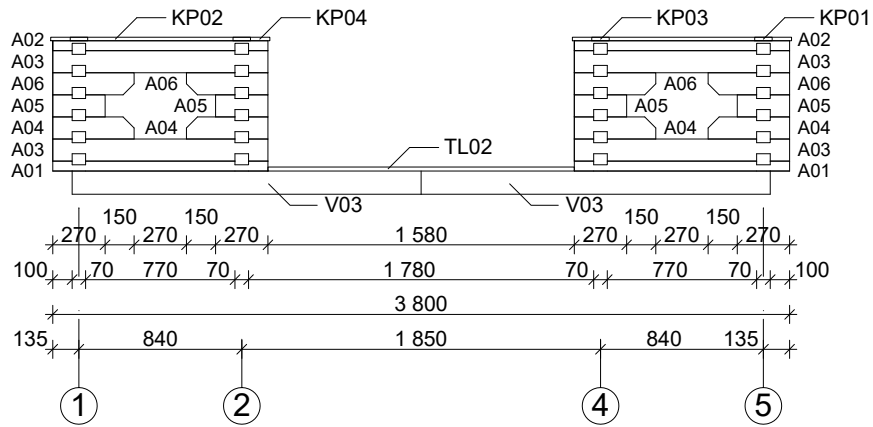

B

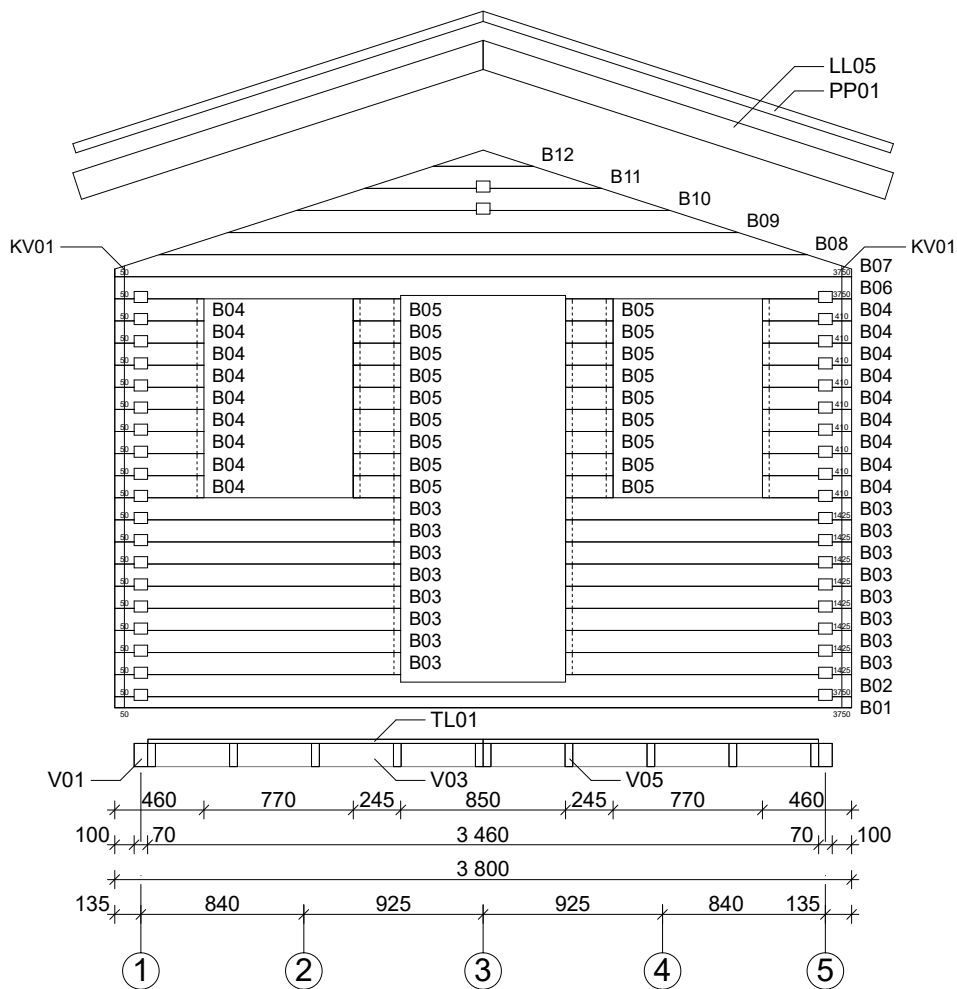

Piha-Aitta 12 / 380 x 234 cm - 70 mm

C

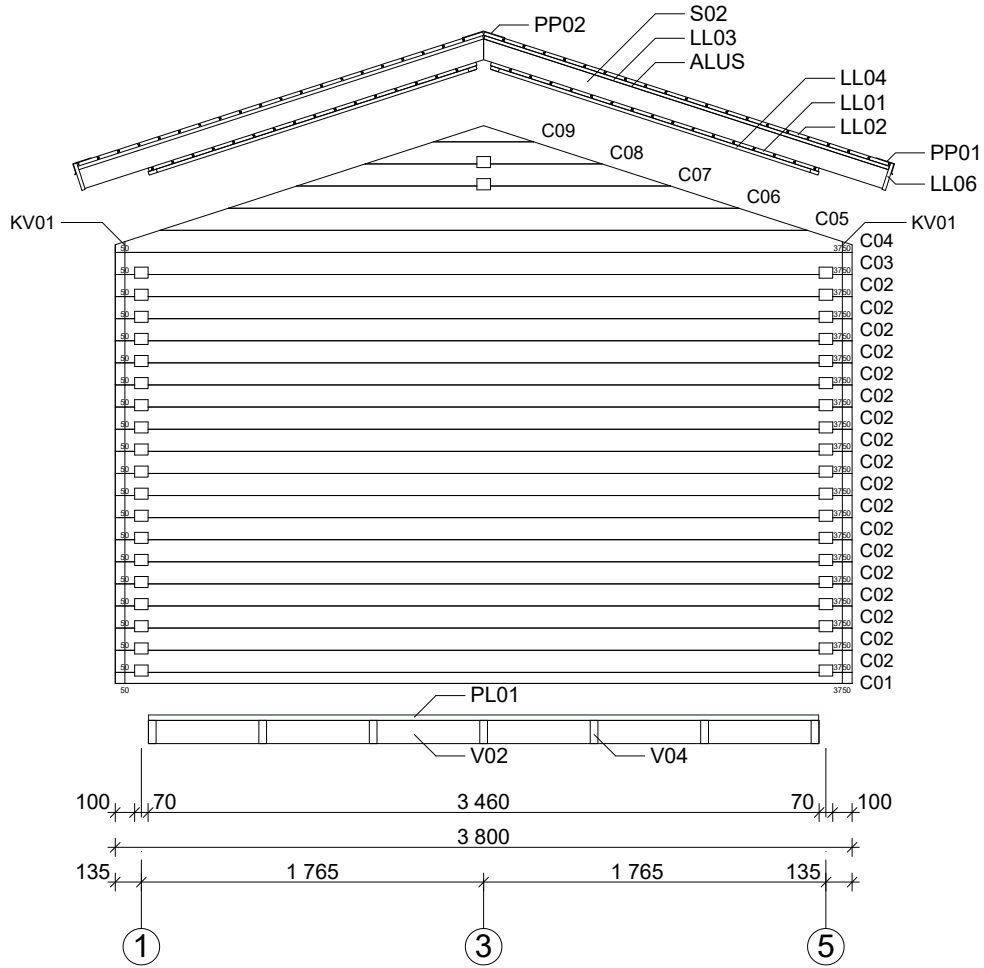

1

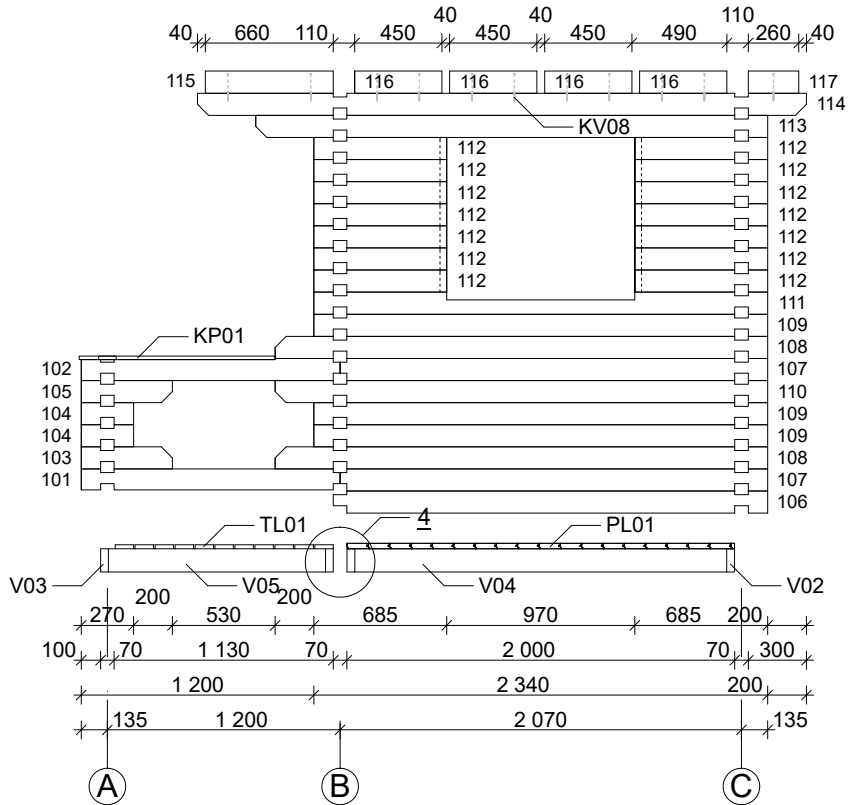

Piha-Aitta 12 / 380 x 234 cm - 70 mm

2

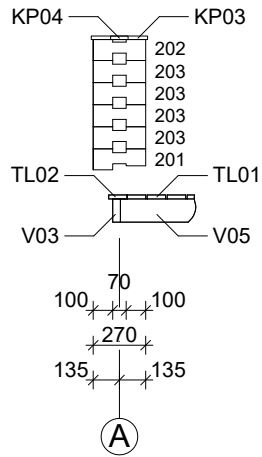

4

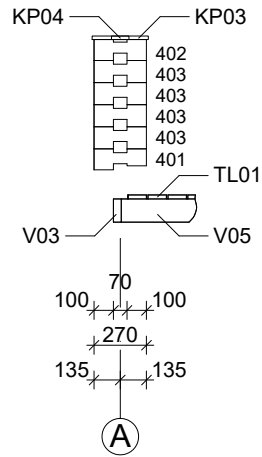

3

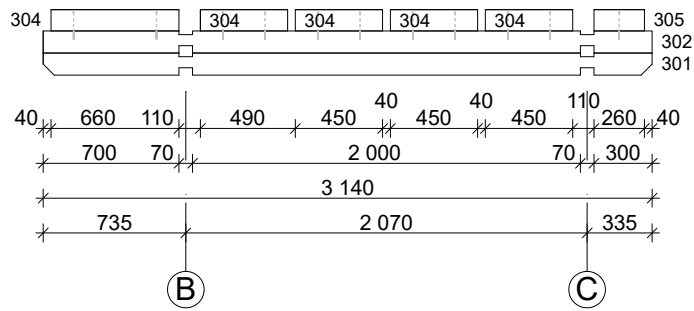

A-A

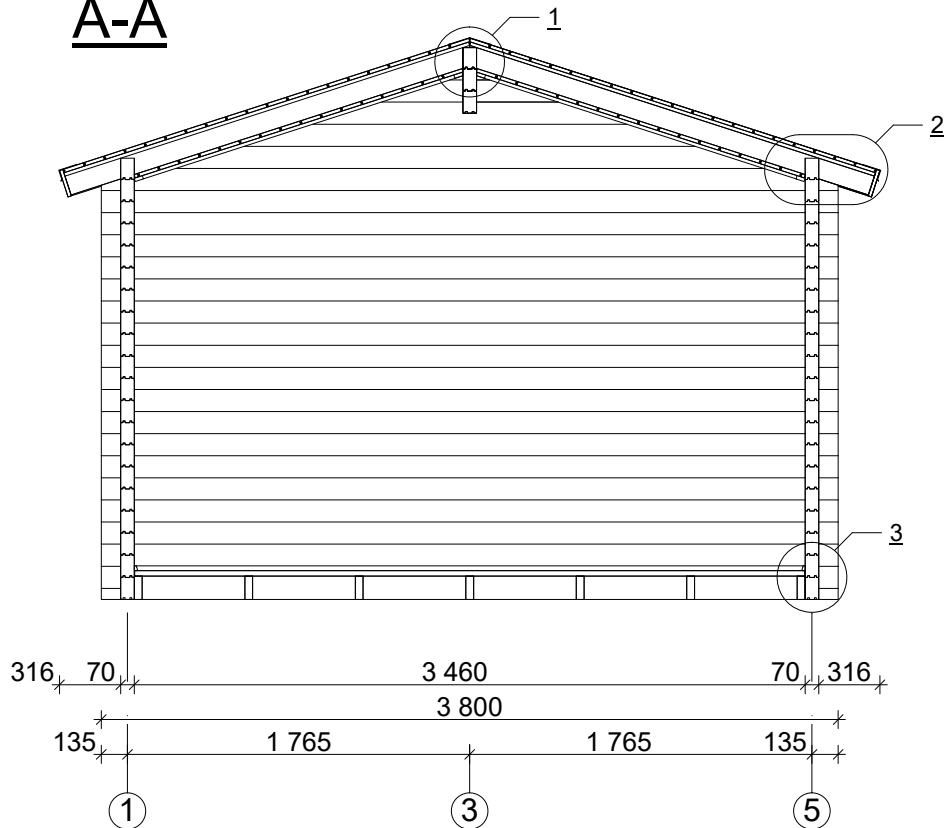

Piha-Aitta 12 / 380 x 234 cm - 70 mm

5

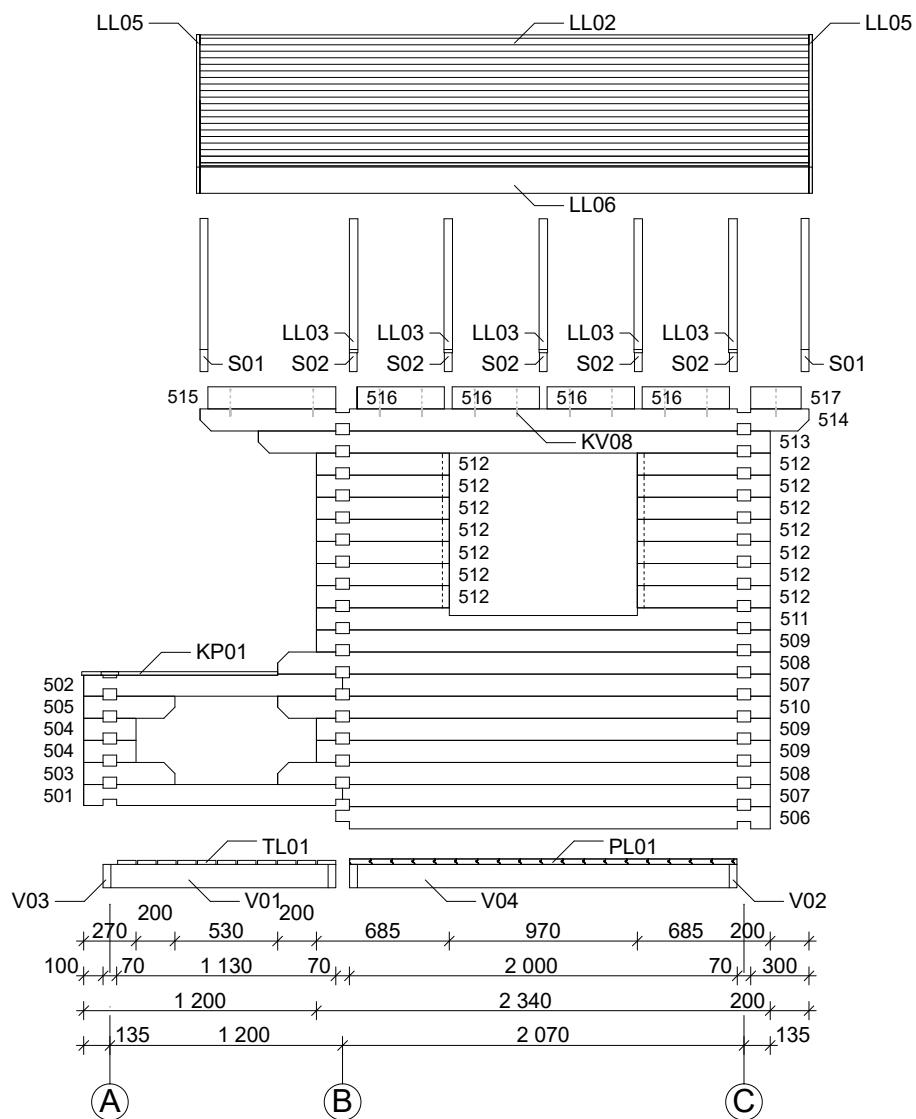

1

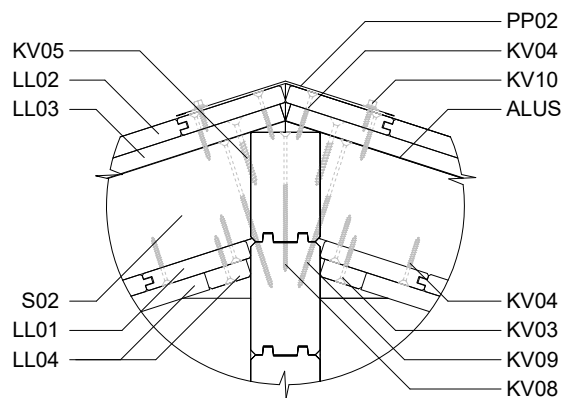

Piha-Aitta 12 / 380 x 234 cm - 70 mm

2

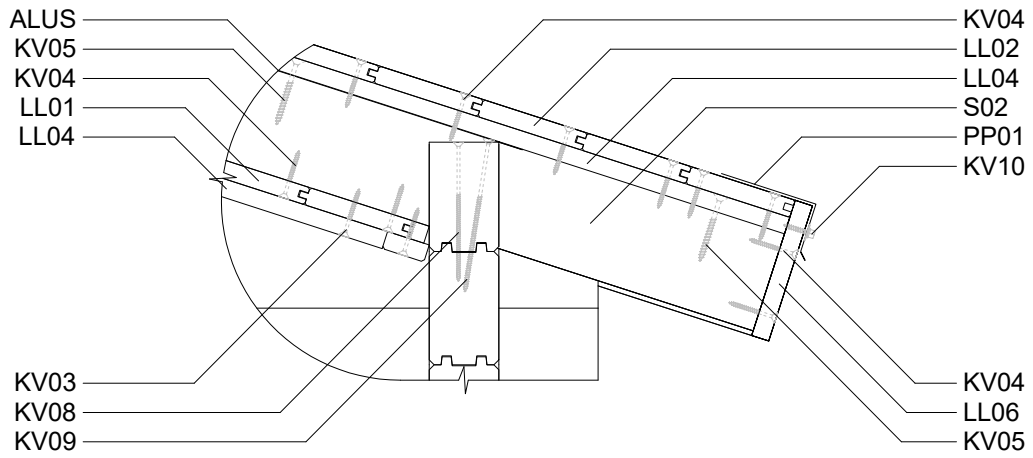



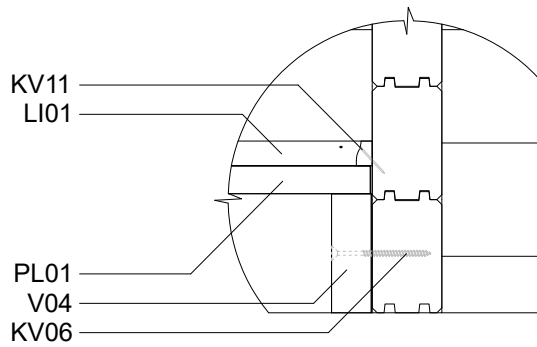



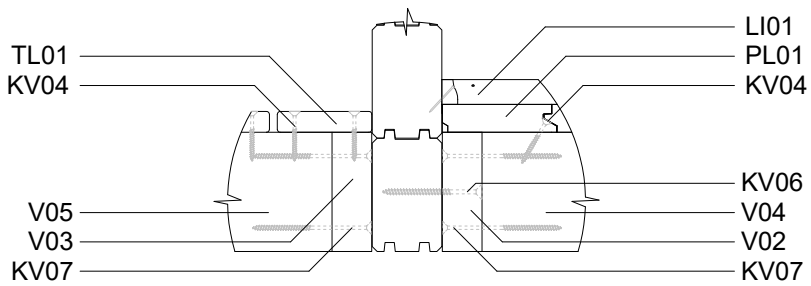



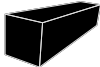

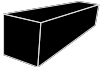

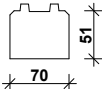
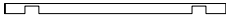
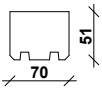
3

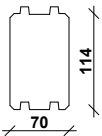



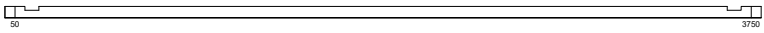
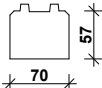
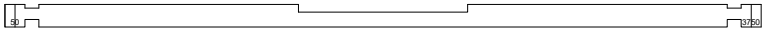
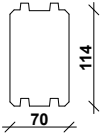
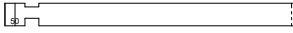

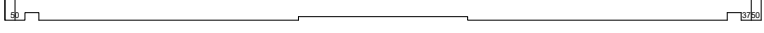





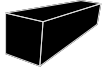

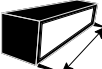
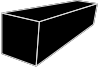

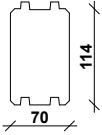
4

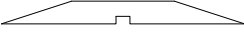
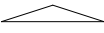

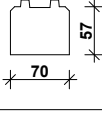

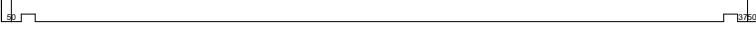



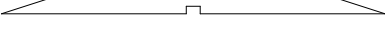
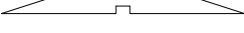
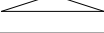







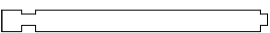
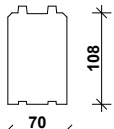
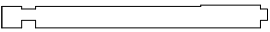
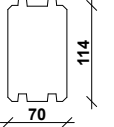
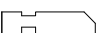

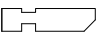

Piha-Aitta 12 / 380 x 234 cm - 70 mm - A; B

Nr.		 mm	 mm	 x
A01			1110	2
A02			1110	2
A03			1110	4
A04			420	4
A05			270	4
A06			420	4
B01			3800	1
B02			3800	1
B03			1475	16
B04			460	18
B05			245	18
B06			3800	1
B07			3800	1
B08			3340	1





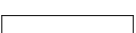
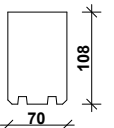





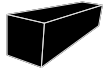

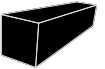

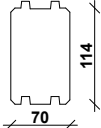

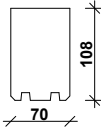

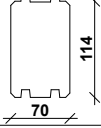

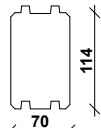

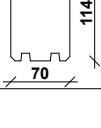

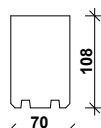
Piha-Aitta 12 / 380 x 234 cm - 70 mm - B; C

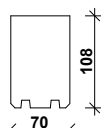
Nr.		 mm	 mm	 x
B09			2634	1
B10			1928	1
B11			1222	1
B12			516	1
C01			3800	1
C02			3800	18
C03			3800	1
C04			3800	1
C05			3340	1
C06			2634	1
C07			1928	1
C08			1222	1
C09			516	1

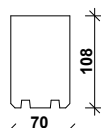

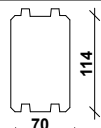

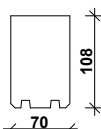

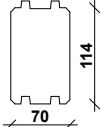





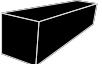
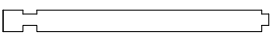
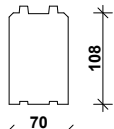
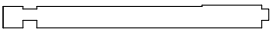
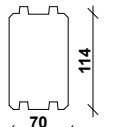



Piha-Aitta 12 / 380 x 234 cm - 70 mm - 1

Nr.		 mm	 mm	 x
101			1335	1
102			1335	1
103			470	1
104			270	2
105			470	1
106			2240	1
107			2205	2
108			2540	2
109			2340	3
110			2540	1
111			2340	1
112		685	14	
113		2640	1	
114		3140	1	
115			660	1
116			450	4
117			260	1



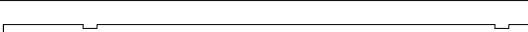

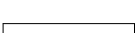
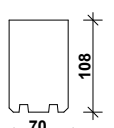









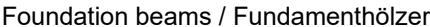

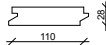

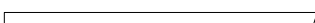
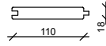
Piha-Aitta 12 / 380 x 234 cm - 70 mm - 2; 3; 4

Nr.		 mm	 mm	 x
201			270	1
202			270	1
203			270	4
301			3140	1
302			3140	1
303			660	1
304			450	4
305			260	1
401			270	1
402			270	1
403			270	4

Piha-Aitta 12 / 380 x 234 cm - 70 mm - 5

Nr.		 mm	 mm	 x
501			1335	1
502			1335	1
503			470	1
504			270	2
505			470	1
506			2240	1
507			2205	2
508			2540	2
509			2340	3
510			2540	1
511			2340	1
512		685	14	
513		2640	1	
514		3140	1	
515			660	1
516			450	4
517			260	1

Piha-Aitta 12 / 380 x 234 cm - 70 mm - Specification / Teileliste

Nr.			 mm	 mm	 x
V01			70 x 120	1120	2
V02			40 x 120	3458	2
V03				1800	4
V04				1918	7
V05				1120	10
TL01	Terrace board / Terrassendielen			1729	22
TL02				1579	1
PL01	Floor boards / Fußbodenbretter			3456	19+1
S01	Rafter / Dachsparren		40x120	2200	4
S02			40x102	2194	10
LL01	Ceiling boards / Deckenbretter			1996	34
LL02	Roof boards / Dachbretter			3140	38+2
LL03	Trim / Leiste		18x44	2194	10
LL04*				ca. 15,4 m	
LL05	Fascia board / Giebelblende		18x143	2225	4
LL06	Eave edging / Traufenbrett			3140	2
LI01	Baseboard / Fußleisten			ca. 11,0 m	
KP01	Handrail / Terrassenabschlußbrett		18x90	1010	2
KP02				750	2
KP03				290	2
KP04				100	4
ALUS*	Underlay / Unterlage			ca. 6,9 m	
PP01	Flashing			2500	7
PP02	Flashing			1700	2
VR01	Ventilation grate ø100 mm				1
VR02	Disc valve ø100 mm				1
KV01	Threaded Rod		ø 10	2330	4
KV02	Nut, washer / Mutter, Scheibe				8
KV03	Screws / Schrauben 4,0 x 40				40
KV04	Screws / Schrauben 4,0 x 50				920
KV05	Screws / Schrauben 5,0 x 70				70
KV06	Screws / Schrauben 5,0 x 100				60
KV07	Screws / Schrauben 5,0 x 120				80
KV08	Screws / Schrauben 6,0 x 140				40
KV09	Screws / Schrauben 6,0 x 160				30
KV10	Roof screw / Dachschraube				60
KV11	Nails / Nägel 1,4 x 35				50
LK	Hit block / Schlaghölzer				
KÄRG	Roofing felt / Dachpappe		roof area ca. 14,1 m ²		--
VILL	Insulation / Dämmung 50 mm		ca. 7,1 m ²		--

