

Art. Nr. 2819396
1/6



17.04.2017

Art.Nr. 2819396



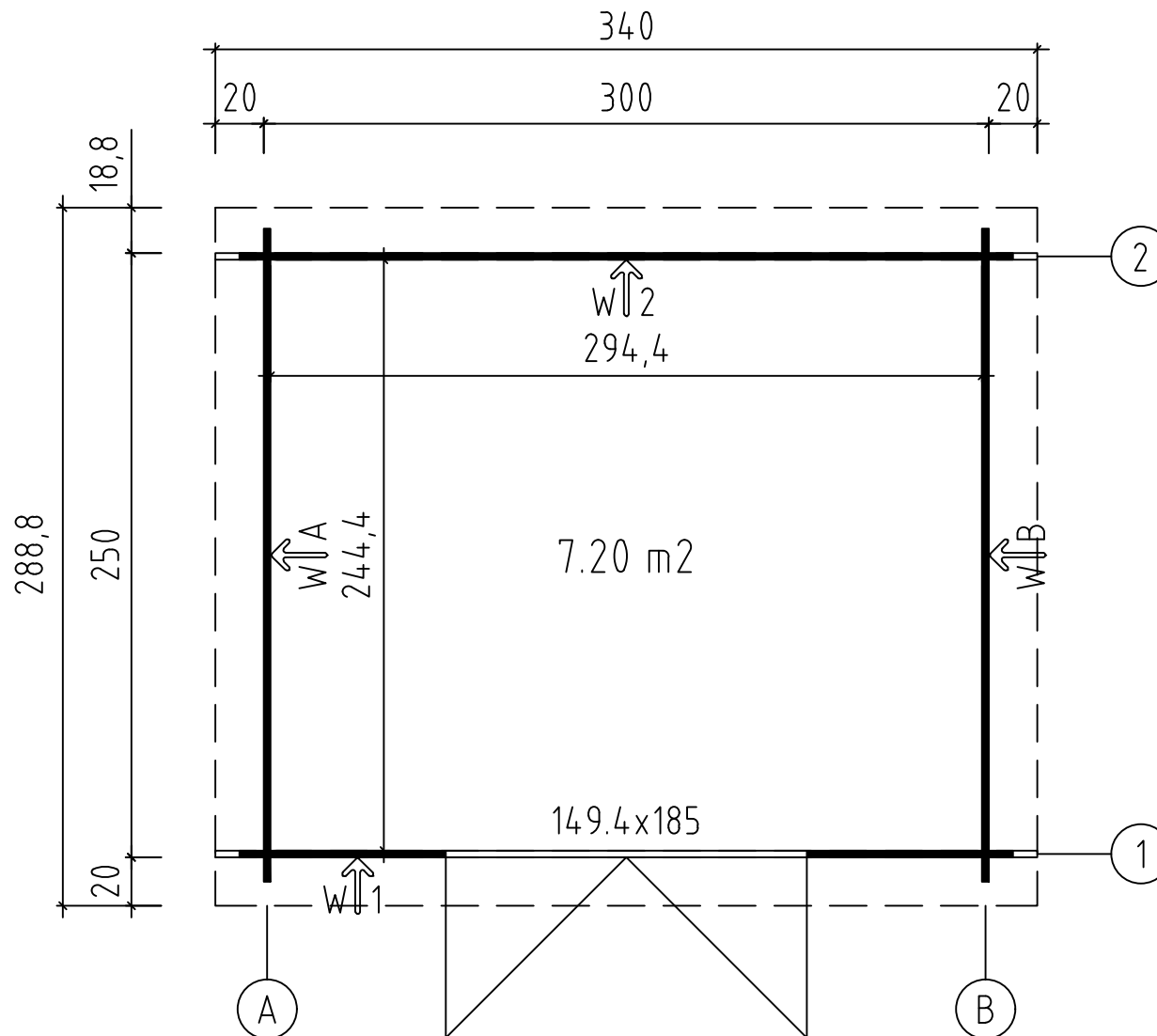

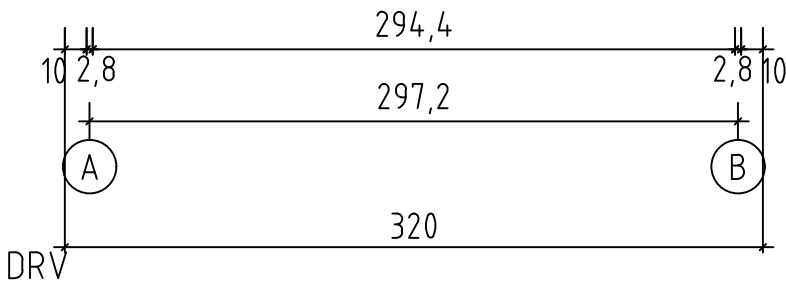
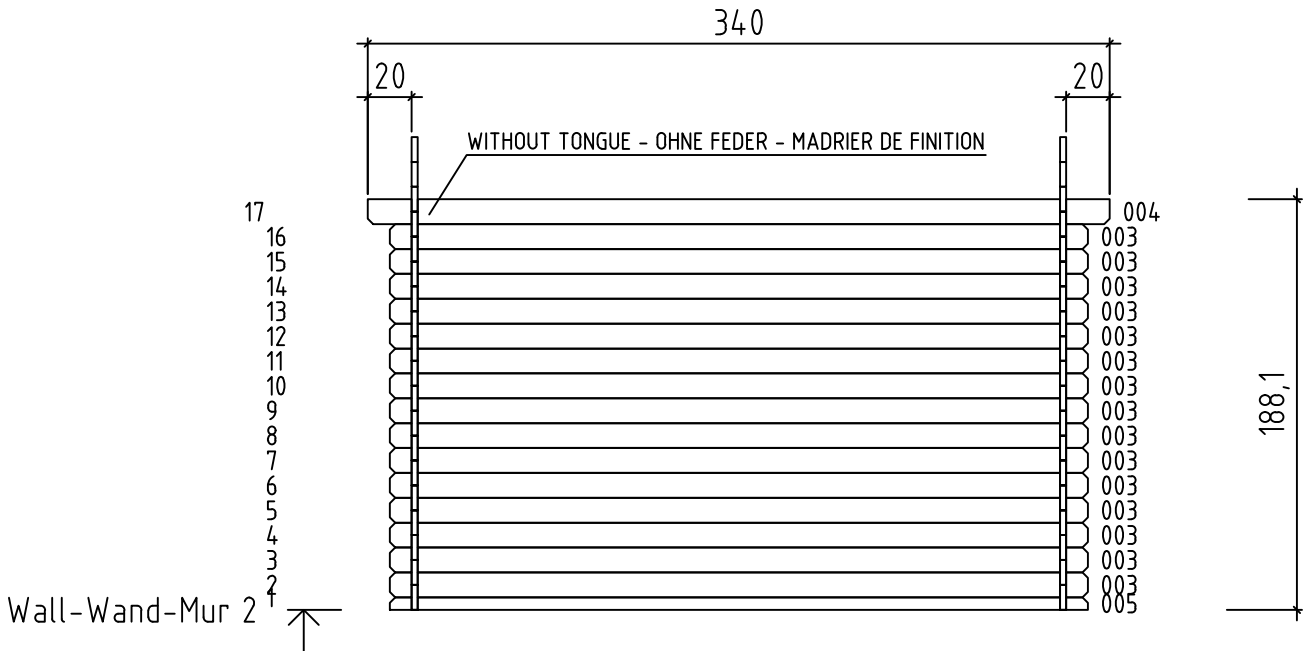
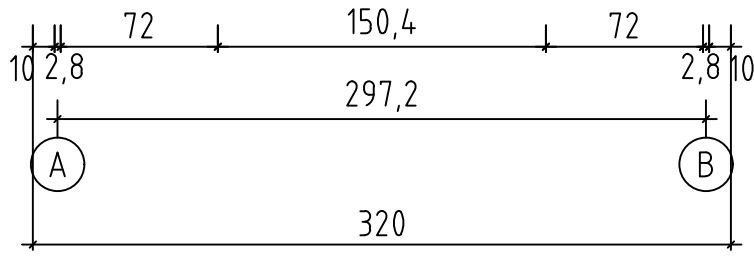
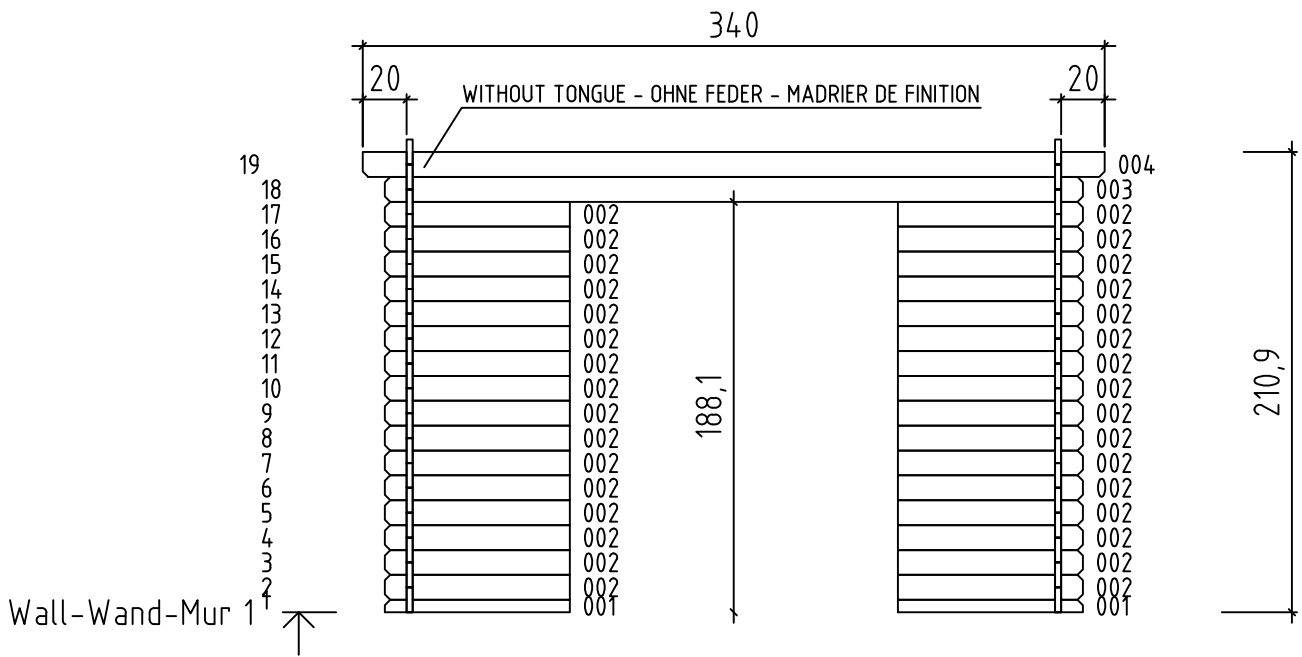

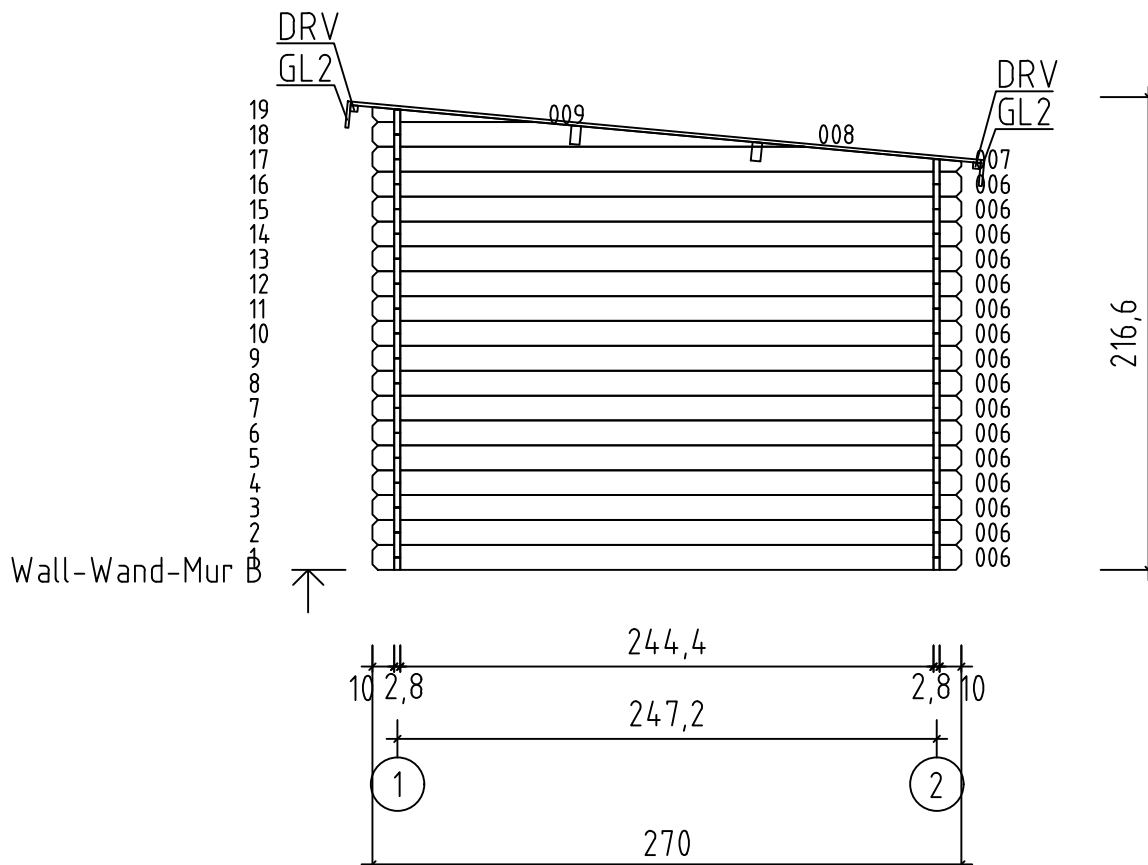
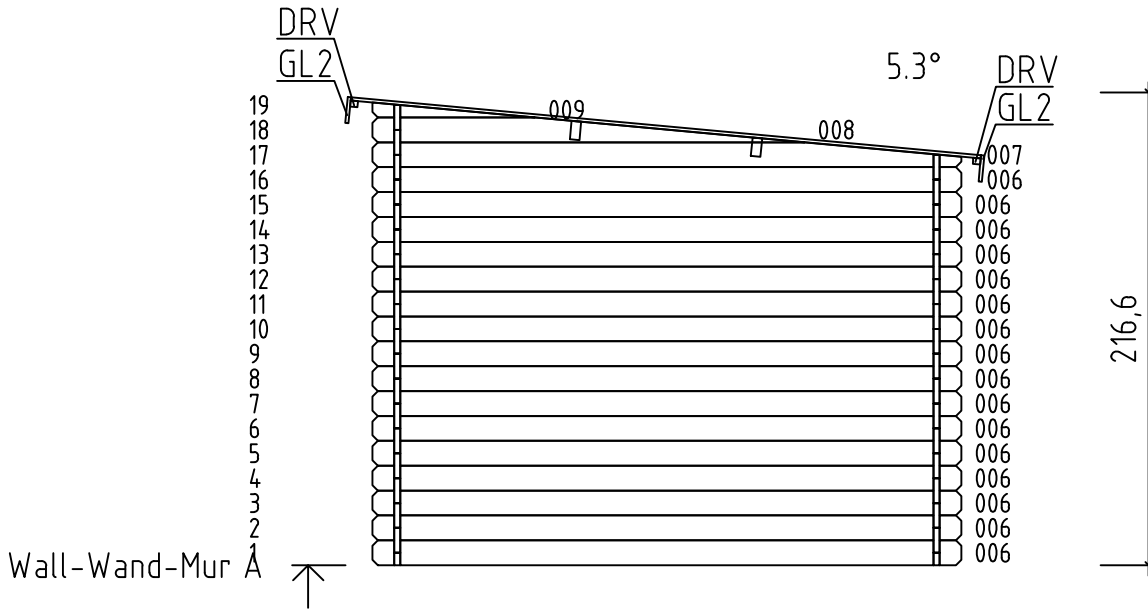

GROUNDPLAN - GRUNDPLAN - PLAN DE MASSE





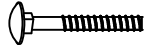

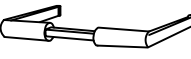

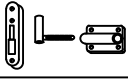
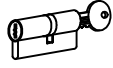
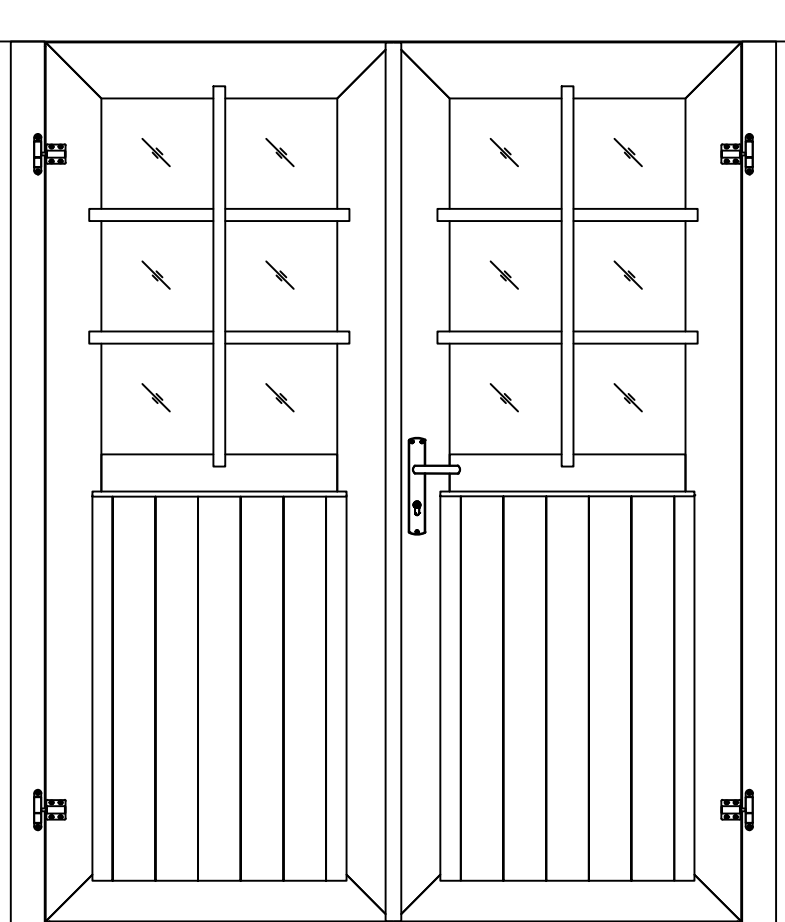

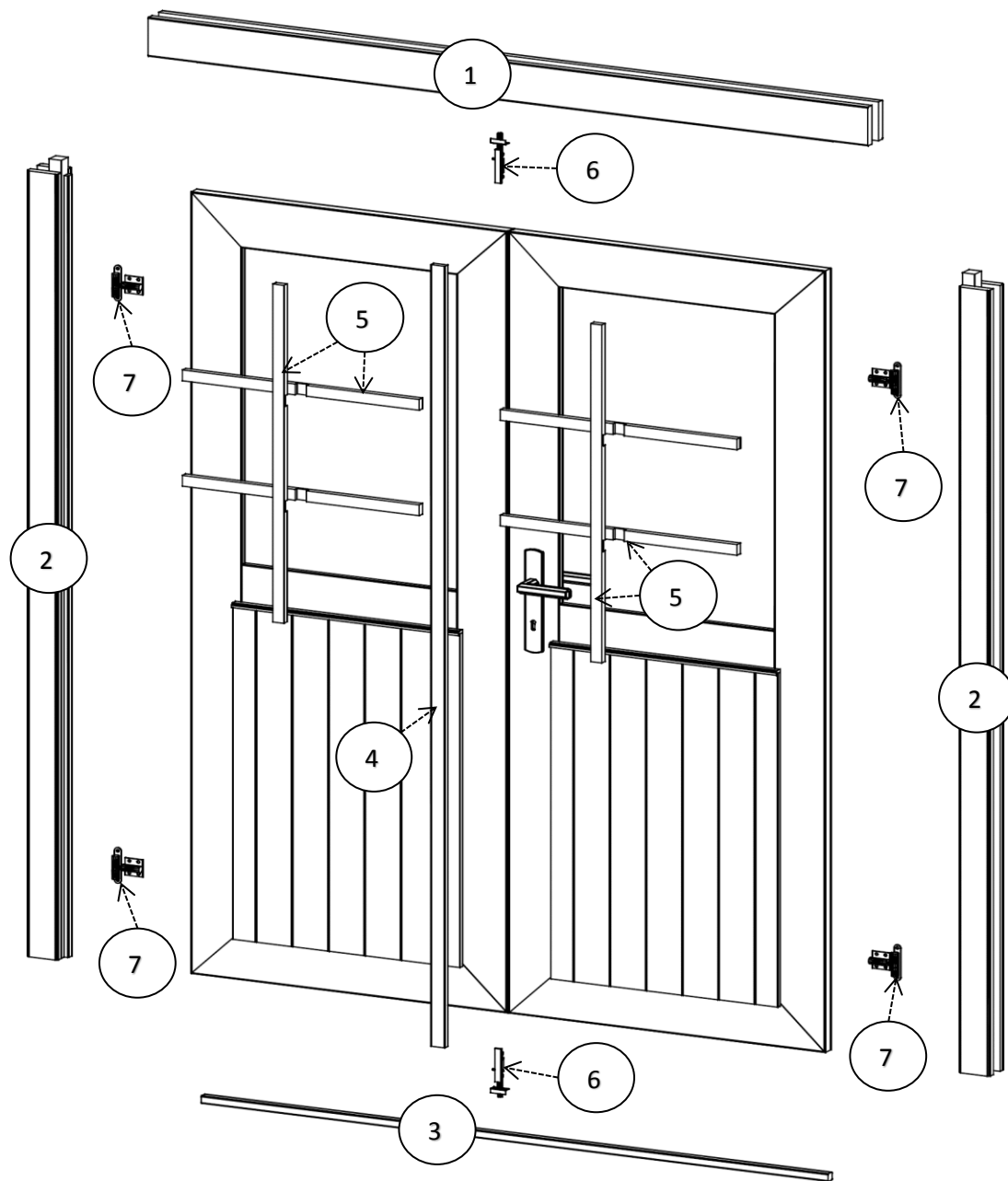
Pos	17.04.2017	Piece list - Stückliste - Liste des pièces Art.Nr. 2819396	5/6	Q.	P (mm)	L (mm)
001				2	28x57	848
002				32	28x114	848
003				16	28x114	3200
004				2	28x114	3400
005				1	28x57	3200
006				32	28x114	2700
WA-1				1		
WB-1				1		
A.PR22				2	44x140	3400
	ROOF BOARDS - DACHBRETTER - VOLIGES			38	90x15	2900
DRV	ROOF EDGE REINFORCEMENT - DACHRANDVERSTÄRKUNG - CORNIERE DE RENFORT DE BORD DE TOIT			2	28x34	3400
KFS	STORM PROTECTION - STURMLEISTE - LATTE ANTI-TEMPETE			4	22x45	2050
GL	GABLE MOULDING - GIEBELLEISTE - PLANCHE DE RIVE			2	15x120	2930
GL2	GABLE MOULDING - GIEBELLEISTE - PLANCHE DE RIVE			2	15x120	3400
HS89	SCREW FOR GEORGIAN BARS - SCHRAUBE FÜR SPROSSEN - VIS DE BARRES GEORGIENNE			12	2.5x20	
HS15	SCREW FOR DOOR JAMB - SCHRAUBE FÜR TÜRRAHMEN - VIS DE FIXATION POUR MONTANT DE PORTE			2	3.5x50	
HS3	SCREW FOR DOOR FILLET - SCHRAUBE ZUR BEFESTIGUNG TÜRLEISTE - VIS D'ASSEMBLAGE DU CADRE DE PORTE			5	3x30	
HS59	SCREW FOR DOORSTEP - SCHRAUBEN FÜR SWELLE - VIS DE FIXATION DU SEUIL DE PORTE			3	3x30	
	SCREW FOR FIXING BOLT HINGE - SCHRAUBE FÜR TÜRRIESEL - VIS DE FIXATION POUR CHARNIERES ET GONDS DE PORTE			16	4x30	
HS32	SCREW FOR EAVES BOARDS - SCHRAUBEN FÜR TRAUFBRETTER - VIS DE FIXATION POUR BANDEAU DE TOIT			32	4x40	
HS26	SCREW FOR ROOF EDGE REINFORCEMENT - SCHRAUBEN FÜR DACHRANDVERSTÄRKUNG - VIS POUR RENFORT DE BORD DE TOIT			16	4x40	
	SCREW FOR FIXING BOLT HINGE - SCHRAUBE FÜR TÜRRIESEL - VIS DE FIXATION POUR CHARNIERES ET GONDS DE PORTE			12	4x40	
HS77	SCREW FOR DOOR JAMB - SCHRAUBE FÜR TÜRRAHMEN - VIS DE FIXATION POUR MONTANT DE PORTE			2	4x60	
HS43	SCREW FOR ROOF BEAMS - SCHRAUBEN FÜR DACHBALKEN - VIS POUR PANNE DE TOIT			4	5x120	
HS42	SCREW FOR GABLE - SCHRAUBEN FÜR GIEBEL - VIS POUR FIXATION DES PIGNONS			12	5x120	

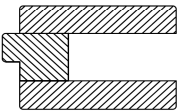
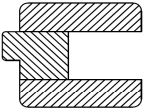
Pos	17.04.2017	Piece list - Stückliste - Liste des pièces Art.Nr. 2819396	6/6	Q.	P (mm)	L (mm)
HS41		SCREW FOR DOOR JAMB - SCHRAUBE FÜR TÜRRAHMEN - VIS DE FIXATION POUR MONTANT DE PORTE		2	5x90	
SH28		HAMMER BLOCK - SCHLAGHOLZ - CALLE DE FRAPPE		1		
TL		LATCH BOLT FÜR DOUBLE DOOR - TÜRRIEGEL - LOQUET POUR DOUBLE PORTE		2		
SFS		NUT FOR STORM PROTECTION - SCHRAUBENMUTTER FÜR STURMLEISTE - ÉCROU POUR LAME ANTI-TEMPETE		8	D6	
BFS		BOLT FOR STORM PROTECTION - BOLZEN FÜR STURMLEISTE - VIS POUR LAME ANTI-TEMPETE		8	6x60	
DFS		WASHER FOR STORM PROTECTION - DICHTSCHEIBE FÜR STURMLEISTE - RONDELLE POUR LAME ANTI-TEMPETE		8	D6	
NF2		ZN NAIL FOR ROOF - ZN NÄGEL FÜR DACHBRETTTER - POINTE POUR TOIT		162	2x50	
TS3		DOOR HANDLE FITTINGS-TÜRGRIFF - SET DE GARNITURES DE SERRURE DE PORTE		1		
TS4		SET OF DOOR LOCK COVERS - SCHLOSSBLENDEN - SET DE GARNITURES DE SERRURE DE PORTE		1		
TT		MALE BOLT HINGE FOR DOOR - TÜRBAND - PARTIE MALE DE CHARNIERE DE PORTE		4		
TS6		CYLINDER LOCK -ZYLINDERSCHLOSS - CYLINDRE DE SERRURE		1		
		DOOR - TÜR - PORTE 1494x1850	TUK.2.056.SVP.MX28 SGA + 28	1		
						

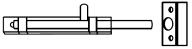
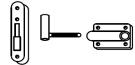

Pos	Piece list - Stückliste - Liste des pièces	Q.	P (mm)
1		1	66x100
2		2	66x80
3		1	18x18
4		1	13x32
5		6	15x25
6		2	
7		4	

