

Assembly, installation and maintenance manual

Montage-, Aufbau- und Wartungsanleitung • Assemblage, manuel de montage et d'entretien • Montaje, instalación y mantenimiento • Manuale di montaggio, installazione e manutenzione • Monterings- og vedlikeholdsmanual • Monterings-, installations- och underhållsmanual • Kokoamis-, asennus- ja huolto-ohje • Vejledning for montering og vedligehold • Handleiding voor montage, installatie en onderhoud • Manual de montagem, instalação e manutenção • Návod k montáži, instalaci a údržbě • Instrukcja montażu, instalacji i konserwacji • Surinkimo, montavimo ir priežiūros vadovas • Montāžas, uzstādīšanas un apkopes rokasgrāmata • Руководство по сборке и обслуживанию • Montaaži-, paigaldus- ja säilitamise juhend









Pavilion **PA28-5830-1**

Treatment options, Item code

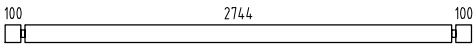
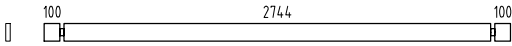
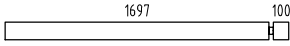
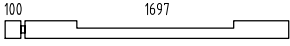

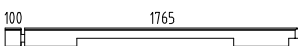
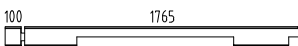
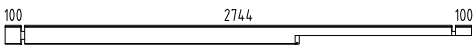
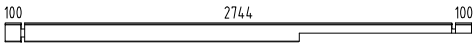
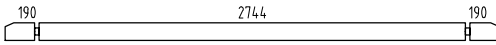

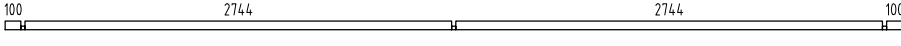
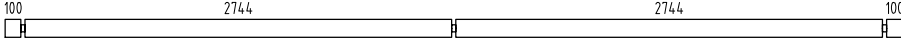
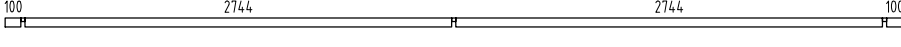
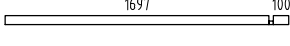
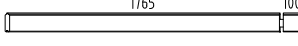
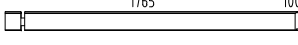
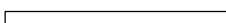

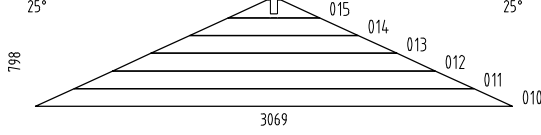

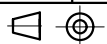





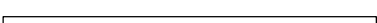





• Behandlungsoptionen, Artikel-Code • Traitement options, code de l'article • Opciones de tratamiento, código del artículo • Opzioni di trattamento, codice articolo • Behandlingsalternativer, artikkelnummer • Behandlingsalternativ, varukod • Käsittelevaihtoehdot, yksikön koodi • Behandlingsmuligheder, artikel nummer • Behandlingsopties, artikelnummer • Opções de tratamento, código do artigo • Povrchové úpravy, kód položky • Możliwości leczenia, kod produktu • Apdorojimo variantai, prekės kodas • Apstrādes iespējas, artikula kods • Варианты обработки, код изделия • Tõõtlusvõimalused, tootekood

NO 103778
BNDIP 103779
GYDIP 103781
WTDIP 103780

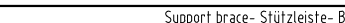
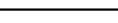







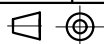

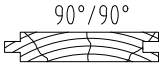

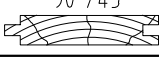
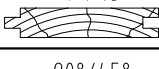
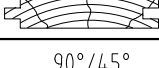
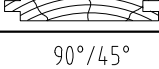
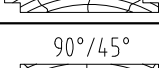
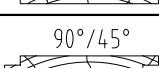
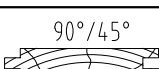
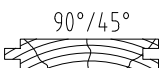
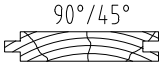
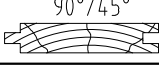
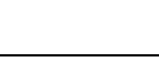
<p>Factory inspection by • Werkskontrolle durch • Contrôle à partir de l'usine par • Inspector de fábrica • Collaudato da • Fabrikkkontroll utført av • Fabriksbesiktigat av • Tehtaan tarkastaja • Fabriks Kontrol udført af • Fabrikscontrole door • Inspeção de fábrica, por: • Zkontrolováno ve výrobním závodě • Kontrola fabryczna do • Apžiūra gamykloje atliko • Rūpnīcas pārbaudi veicis • Заводской контроль • Tehase kontroll teostatud:</p> <p>.....</p>	<p>Date • Datum • Date • Fecha • Data • Dato • Datum • Päiväys • Dato • Datum • Data • Datum • Data • Datums • Data • Дата • Kuupäev:</p> <hr/> <p>Pack number • Pack Nr. • Packet n° • Bulto N° • Pacco N. • Serienr • Produktionsnummer • Pakettinro • Pakke nr. • Pak nr. • Número de embalagem • Číslo balení • Numer opakowania • Pakuotės numeris • Iepakojuma numurs • Упаковочный номер • Pakinumber:</p>
---	---

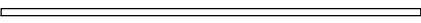
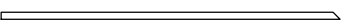

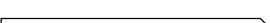



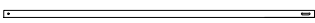









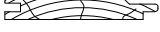

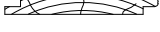
Pos	SPECIFICATION-STÜCKLISTE-NOMENCLATURE-ELEMENTI-ESPECIFICACIÓN PA28-5830-1	Pcs	Profile (mm)	Length (mm)
001		21	28x114	3000
002		2	28x114	3000
003		4	28x114	1825
004		1	28x114	1825
005		45	28x114	460
006		27	28x114	355
007a		1	28x114	1893
007b		1	28x114	1893
008a		1	28x114	3000
008b		1	28x114	3000
009		1	28x114	3180
016		1	28x57	190
017		1	28x57	5772
018		21	28x114	5772
019		2	28x57	5772
020		1	28x57	1825
021a		1	28x114	1893
021b		1	28x114	1893
022		1	28x114	1440
023		1	28x55	1440
W2-1		1		



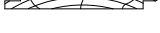
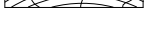

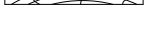

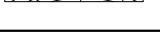
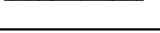

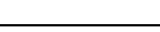
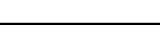









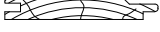

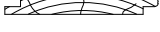
Pos	SPECIFICATION-STÜCKLISTE-NOMENCLATURE-ELEMENTI-ESPECIFICACIÓN PA28-5830-1	Pcs	Profile (mm)	Length (mm)
BM1	Beam- Balken- Poutre- Trave- Viga 	1	44x140	2740
Det2	Detail- Detail- Detail- Dettaglio- Detalle 	1	70x70	1910
Det1	Detail- Detail- Detail- Dettaglio- Detalle 	1	70x70	1910
EaE1	Eave edging- Dachrandbrett- Madrier en bordure du toit- Tavola bordo tetto- Tabla de valadizo 	2	19x120	3630
EaE3	Eave edging- Dachrandbrett- Madrier en bordure du toit- Tavola bordo tetto- Tabla de valadizo 	2	19x120	3225
EaE2	Eave edging- Dachrandbrett- Madrier en bordure du toit- Tavola bordo tetto- Tabla de valadizo 	2	19x120	2400
Pst3	Post- Pfosten- Poteau- Montante- Poste 	1	90x90	2150
Pst2	Post- Pfosten- Poteau- Montante- Poste 	1	70x70	750
Pst1	Post- Pfosten- Poteau- Montante- Poste 	1	70x70	750
RoR3	Rafter- Sparre- Chevron- Trave- Cabrio 	2	44x95	2377
RoR4	Rafter- Sparre- Chevron- Trave- Cabrio 	2	44x95	2377
RoR5	Rafter- Sparre- Chevron- Trave- Cabrio 	8	44x95	1763
RoR2	Rafter- Sparre- Chevron- Trave- Cabrio 	4	44x95	1258
RoR1	Rafter- Sparre- Chevron- Trave- Cabrio 	4	44x95	1258
Sla1	Slat- Leiste- Baguette- Listello- Listón 	1	19x28	1520
SP2	Support brace- Stützleiste- Baguette de support- Listello di supporto- Listón de soporte 	1	120x28	2200
SP1	Support brace- Stützleiste- Baguette de support- Listello di supporto- Listón de soporte 	2	44x95	780
UP5	U-profile board- U-Profilleiste- Baguette profilée en U- Listello profilo ad U- Listón de perfil U 	2	44x88	900
UP3	U-profile board- U-Profilleiste- Baguette profilée en U- Listello profilo ad U- Listón de perfil U 	4	44x88	878
UP1	U-profile board- U-Profilleiste- Baguette profilée en U- Listello profilo ad U- Listón de perfil U 	4	44x88	878
UP2	U-profile board- U-Profilleiste- Baguette profilée en U- Listello profilo ad U- Listón de perfil U 	12	44x88	578
UP4	U-profile board- U-Profilleiste- Baguette profilée en U- Listello profilo ad U- Listón de perfil U 	1	25x55	2010
PR1	Purlin- Dachpfette- Arbalétrier- Arcareccio- Correa 	1	44x120	2903



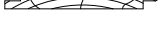
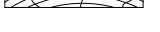

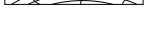

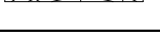
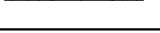

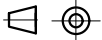



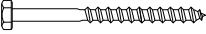
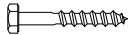

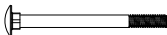

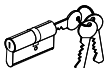













Pos	SPECIFICATION-STÜCKLISTE-NOMENCLATURE-ELEMENTI-ESPECIFICACIÓN PA28-5830-1	Pcs	Profile (mm)	Length (mm)
FB2-1	Floor board- Fussbodenbrett- Madrier du plancher - Tavola pavimento- Tabla de suelo 	20	89x19	2735
2FB2-1	Floor board- Fussbodenbrett- Madrier du plancher - Tavola pavimento- Tabla de suelo 2 	1	89x19	2735
2FB2-2	Floor board- Fussbodenbrett- Madrier du plancher - Tavola pavimento- Tabla de suelo 2 	1	89x19	2646
2FB2-3	Floor board- Fussbodenbrett- Madrier du plancher - Tavola pavimento- Tabla de suelo 2 	1	89x19	2557
2FB2-4	Floor board- Fussbodenbrett- Madrier du plancher - Tavola pavimento- Tabla de suelo 2 	1	89x19	2468
2FB2-5	Floor board- Fussbodenbrett- Madrier du plancher - Tavola pavimento- Tabla de suelo 2 	1	89x19	2379
2FB2-6	Floor board- Fussbodenbrett- Madrier du plancher - Tavola pavimento- Tabla de suelo 2 	1	89x19	2290
2FB2-7	Floor board- Fussbodenbrett- Madrier du plancher - Tavola pavimento- Tabla de suelo 2 	1	89x19	2201
2FB2-8	Floor board- Fussbodenbrett- Madrier du plancher - Tavola pavimento- Tabla de suelo 2 	1	89x19	2112
2FB2-9	Floor board- Fussbodenbrett- Madrier du plancher - Tavola pavimento- Tabla de suelo 2 	1	89x19	2023
2FB2-10	Floor board- Fussbodenbrett- Madrier du plancher - Tavola pavimento- Tabla de suelo 2 	1	89x19	1934
2FB2-11	Floor board- Fussbodenbrett- Madrier du plancher - Tavola pavimento- Tabla de suelo 2 	1	89x19	1845
2FB2-12	Floor board- Fussbodenbrett- Madrier du plancher - Tavola pavimento- Tabla de suelo 2 	1	89x19	1756
AR1	Foundation- Fundament- Fondation- Fondazione- Vigas de cimentación 	1	70x45	5517
AR3	Foundation- Fundament- Fondation- Fondazione- Vigas de cimentación 	4	70x45	2700
AR6	Foundation- Fundament- Fondation- Fondazione- Vigas de cimentación 	1	70x45	2180
AR2	Foundation- Fundament- Fondation- Fondazione- Vigas de cimentación 	1	70x45	1758
AR5	Foundation- Fundament- Fondation- Fondazione- Vigas de cimentación 	1	70x45	1713
AR4	Foundation- Fundament- Fondation- Fondazione- Vigas de cimentación 	2	70x45	1460
AR7	Foundation- Fundament- Fondation- Fondazione- Vigas de cimentación 	1	70x45	348
FIB2-1	Floor beading- Fussbodenleiste- Baguette du plancher- Listello pavimento- Listón de suelo 	6	19x19	1940
Rel-1	Roof element- Dachelement- Panneau de toit- Elemento di tetto- Elemento tejado 	1		1767
StB1-1	Storm brace- Sturmleiste- Protection contre le vent- Antivento- Protector contra tormentas 	5	25x45	2200
	Object name PA28-5830-1	Page		3/7

Pos	SPECIFICATION-STÜCKLISTE-NOMENCLATURE-ELEMENTI-ESPECIFICACIÓN PA28-5830-1		Pcs	Profile (mm)	Length (mm)	
RB1-1	Roof board- Dachbrett- Madrier du toit- Tavola tetto- Tabla de tejado		48°/48°	2	89x16	4631
RB1-2	Roof board- Dachbrett- Madrier du toit- Tavola tetto- Tabla de tejado		48°/48°	2	89x16	4467
RB1-3	Roof board- Dachbrett- Madrier du toit- Tavola tetto- Tabla de tejado		48°/48°	2	89x16	4304
RB1-4	Roof board- Dachbrett- Madrier du toit- Tavola tetto- Tabla de tejado		48°/48°	2	89x16	4140
RB1-5	Roof board- Dachbrett- Madrier du toit- Tavola tetto- Tabla de tejado		48°/48°	2	89x16	3977
RB1-6	Roof board- Dachbrett- Madrier du toit- Tavola tetto- Tabla de tejado		48°/48°	2	89x16	3813
RB1-7	Roof board- Dachbrett- Madrier du toit- Tavola tetto- Tabla de tejado		48°/48°	2	89x16	3649
RB1-8	Roof board- Dachbrett- Madrier du toit- Tavola tetto- Tabla de tejado		48°/48°	2	89x16	3486
RB1-9	Roof board- Dachbrett- Madrier du toit- Tavola tetto- Tabla de tejado		48°/48°	2	89x16	3322
RB1-10	Roof board- Dachbrett- Madrier du toit- Tavola tetto- Tabla de tejado		48°/48°	2	89x16	3159
RB1-11	Roof board- Dachbrett- Madrier du toit- Tavola tetto- Tabla de tejado		48°/48°	2	89x16	2995
RB1-12	Roof board- Dachbrett- Madrier du toit- Tavola tetto- Tabla de tejado		48°/48°	2	89x16	2832
CB1-1	Roof board- Dachbrett- Madrier du toit- Tavola tetto- Tabla de tejado 2		48°/48°	2	89x16	3167
CB1-2	Roof board- Dachbrett- Madrier du toit- Tavola tetto- Tabla de tejado 2		48°/48°	2	89x16	3004
CB1-3	Roof board- Dachbrett- Madrier du toit- Tavola tetto- Tabla de tejado 2		48°/48°	2	89x16	2840
CB1-4	Roof board- Dachbrett- Madrier du toit- Tavola tetto- Tabla de tejado 2		48°/48°	2	89x16	2677
CB1-5	Roof board- Dachbrett- Madrier du toit- Tavola tetto- Tabla de tejado 2		48°/48°	2	89x16	2513
CB1-6	Roof board- Dachbrett- Madrier du toit- Tavola tetto- Tabla de tejado 2		48°/48°	2	89x16	2349
CB1-7	Roof board- Dachbrett- Madrier du toit- Tavola tetto- Tabla de tejado 2		48°/48°	2	89x16	2186
CB1-8	Roof board- Dachbrett- Madrier du toit- Tavola tetto- Tabla de tejado 2		48°/48°	2	89x16	2022
CB1-9	Roof board- Dachbrett- Madrier du toit- Tavola tetto- Tabla de tejado 2		48°/48°	2	89x16	1859
CB1-10	Roof board- Dachbrett- Madrier du toit- Tavola tetto- Tabla de tejado 2		48°/48°	2	89x16	1695
CB1-11	Roof board- Dachbrett- Madrier du toit- Tavola tetto- Tabla de tejado 2		48°/48°	2	89x16	1532
CB1-12	Roof board- Dachbrett- Madrier du toit- Tavola tetto- Tabla de tejado 2		48°/48°	2	89x16	1368
CB1-13	Roof board- Dachbrett- Madrier du toit- Tavola tetto- Tabla de tejado 2		48°/48°	2	89x16	1205

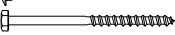
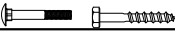

Pos	SPECIFICATION-STÜCKLISTE-NOMENCLATURE-ELEMENTI-ESPECIFICACIÓN PA28-5830-1		Pcs	Profile (mm)	Length (mm)	
CB1-14	Roof board- Dachbrett- Madrier du toit- Tavola tetto- Tabla de tejado 2		48°/48°	2	89x16	1041
CB1-15	Roof board- Dachbrett- Madrier du toit- Tavola tetto- Tabla de tejado 2		48°/48°	2	89x16	877
CB1-16	Roof board- Dachbrett- Madrier du toit- Tavola tetto- Tabla de tejado 2		48°/48°	2	89x16	714
CB1-17	Roof board- Dachbrett- Madrier du toit- Tavola tetto- Tabla de tejado 2		48°/48°	2	89x16	550
CB1-18	Roof board- Dachbrett- Madrier du toit- Tavola tetto- Tabla de tejado 2		48°/48°	2	89x16	387
CB1-19	Roof board- Dachbrett- Madrier du toit- Tavola tetto- Tabla de tejado 2		48°/48°	2	89x16	223
UL1-1	Roof board- Dachbrett- Madrier du toit- Tavola tetto- Tabla de tejado 3		90°/48°	2	89x16	3584
UL1-2	Roof board- Dachbrett- Madrier du toit- Tavola tetto- Tabla de tejado 3		48°/90°	2	89x16	3502
UL1-3	Roof board- Dachbrett- Madrier du toit- Tavola tetto- Tabla de tejado 3		90°/48°	2	89x16	3420
UL1-4	Roof board- Dachbrett- Madrier du toit- Tavola tetto- Tabla de tejado 3		48°/90°	2	89x16	3338
UL1-5	Roof board- Dachbrett- Madrier du toit- Tavola tetto- Tabla de tejado 3		90°/48°	2	89x16	3257
UL1-6	Roof board- Dachbrett- Madrier du toit- Tavola tetto- Tabla de tejado 3		48°/90°	2	89x16	3175
UL1-7	Roof board- Dachbrett- Madrier du toit- Tavola tetto- Tabla de tejado 3		90°/48°	2	89x16	3093
UL1-8	Roof board- Dachbrett- Madrier du toit- Tavola tetto- Tabla de tejado 3		48°/90°	2	89x16	3011
UL1-9	Roof board- Dachbrett- Madrier du toit- Tavola tetto- Tabla de tejado 3		48°/90°	2	89x16	2356
UL1-10	Roof board- Dachbrett- Madrier du toit- Tavola tetto- Tabla de tejado 3		90°/48°	2	89x16	2274
UL1-11	Roof board- Dachbrett- Madrier du toit- Tavola tetto- Tabla de tejado 3		48°/90°	2	89x16	2192
UL1-12	Roof board- Dachbrett- Madrier du toit- Tavola tetto- Tabla de tejado 3		90°/48°	2	89x16	2110
UL1-13	Roof board- Dachbrett- Madrier du toit- Tavola tetto- Tabla de tejado 3		48°/90°	2	89x16	2029
UL1-14	Roof board- Dachbrett- Madrier du toit- Tavola tetto- Tabla de tejado 3		90°/48°	2	89x16	1947
UL1-15	Roof board- Dachbrett- Madrier du toit- Tavola tetto- Tabla de tejado 3		48°/90°	2	89x16	1865
UL1-16	Roof board- Dachbrett- Madrier du toit- Tavola tetto- Tabla de tejado 3		90°/48°	2	89x16	1783
 Object name PA28-5830-1				Page 5/7		

Pos	SPECIFICATION-STÜCKLISTE-NOMENCLATURE-ELEMENTI-ESPECIFICACIÓN PA28-5830-1	Pcs	
Fim	-Fixing kit- Befestigungsset- Moyens de fixation- Materiale di fissaggio- Kit de fijación	1	 USE
QLA80	Adjustment bolt - Senkbolzen - Boulon de réglage - Bullone di regolamento- Perno de ajuste 80-120	1	 Pst3
QKRKK8 x120Zn	Bolt -Schloss-schraube -Boulon- Bullone- Perno- 8x120mm KSKR	2	 Pst1&2+Pst3
QKRKK 8x70Zn	Bolt -Schloss-schraube -Boulon- Bullone- Perno- 8x70mm KSKR	2	 
QPOYP8 x100Zn	Bolt -Schloss-schraube -Boulon- Bullone- Perno- M8x100mm PUP0	4	 Pst1&2&+Wall
QPOYP 8x60Zn	Bolt -Schloss-schraube -Boulon- Bullone- Perno- M8x60mm PUP0	14	 StB1-1; SP2
QULSI 30x35	Cylinder- Zylinderschloss- Serrure a mortaiser- Serratura a cilindro- Bombin- 30.35	1	 TU28-61P
QLIU KAPal	Door fittings- Türbeschlag- Ferrure- Ferramenta porta- Manilla puerta- QLIUKAPal	1	 TU28-61P
QKRYP 6_3x1 05kZnSK	Furniture screw- Innensechskantschraube- Vis Allen- Vite Allen- Tornillo Allen- 6.3x105mm	2	 UP4+Wall
QKA20	Hole plug- Abdeckkappe- Cache-vis- Tappi in legno- Embellecedor- QKA20	2	 Pst1; Pst2
QHA1 50Zn	Hook- Haken- Crochet- Ganzio- Pestillo QHA150Zn	2	 TU28-61P+Wall
QRV1 20Zn	Keeper- Schliessblech- Tole- Lamiera- Aldaba de candado- 120Zn	1	 TU28-61P
QNU20 x20x40	L-iron- Winkel- Angle -Angolo- Angulo 20x20x40	3	 017+AR1
QNA1 4x40Me	Nail- Nagel- Clou- Chiodo- Clavo- 1.4x40mm	100	 FIB2-1; UP1&2&3&5+Wall
QNA2 2x50Zn	Nail- Nagel- Clou- Chiodo- Clavo- 2.5x50mm	1000	 FB2-1; 2FB2-x; RB1-x; CB1-x; UB1-x
QMUK K8Zn	Nut- Schraubenmutter- Écrou- Dado- Tuerca- M8mm	18	 
QKRPP2 5x16Zn	Screw- Schraube- Vis- Vite- Tornillo- 2.5x16mm Zn	2	 
QKRPP 3x20Zn	Screw- Schraube- Vis- Vite- Tornillo- 3x20mm	60	 TU28-61R; TA28-12P
QKRPP4 5x50Zn	Screw- Schraube- Vis- Vite- Tornillo- 4.5x50mm	80	 Rel-1; EaEx; ...
QKRPP4 5x70Zn	Screw- Schraube- Vis- Vite- Tornillo- 4.5x70mm	100	 017; 019; 020; Rel-1; BM1; UP1&3; SiS5-1; SP1; Pstx;
QKRPP 4x25Zn	Screw- Schraube- Vis- Vite- Tornillo- 4x25mm	12	 
QKRPP 5x90Zn	Screw- Schraube- Vis- Vite- Tornillo- 5x90mm	100	 SP1; RoRx+Wall; Rel-1 RoRx+RoR3; PR1 TU28-61P; 022; 023
QKRPP6 x120Zn	Screw- Schraube- Vis- Vite- Tornillo- 6x120mm	50	 ARx; RoRx+Wall
QSE8x20 Zn	Washer- Dichtscheibe- Joint- Rondella- Arandela- 8x20mm	22	  
	Object name PA28-5830-1		Page 6/7

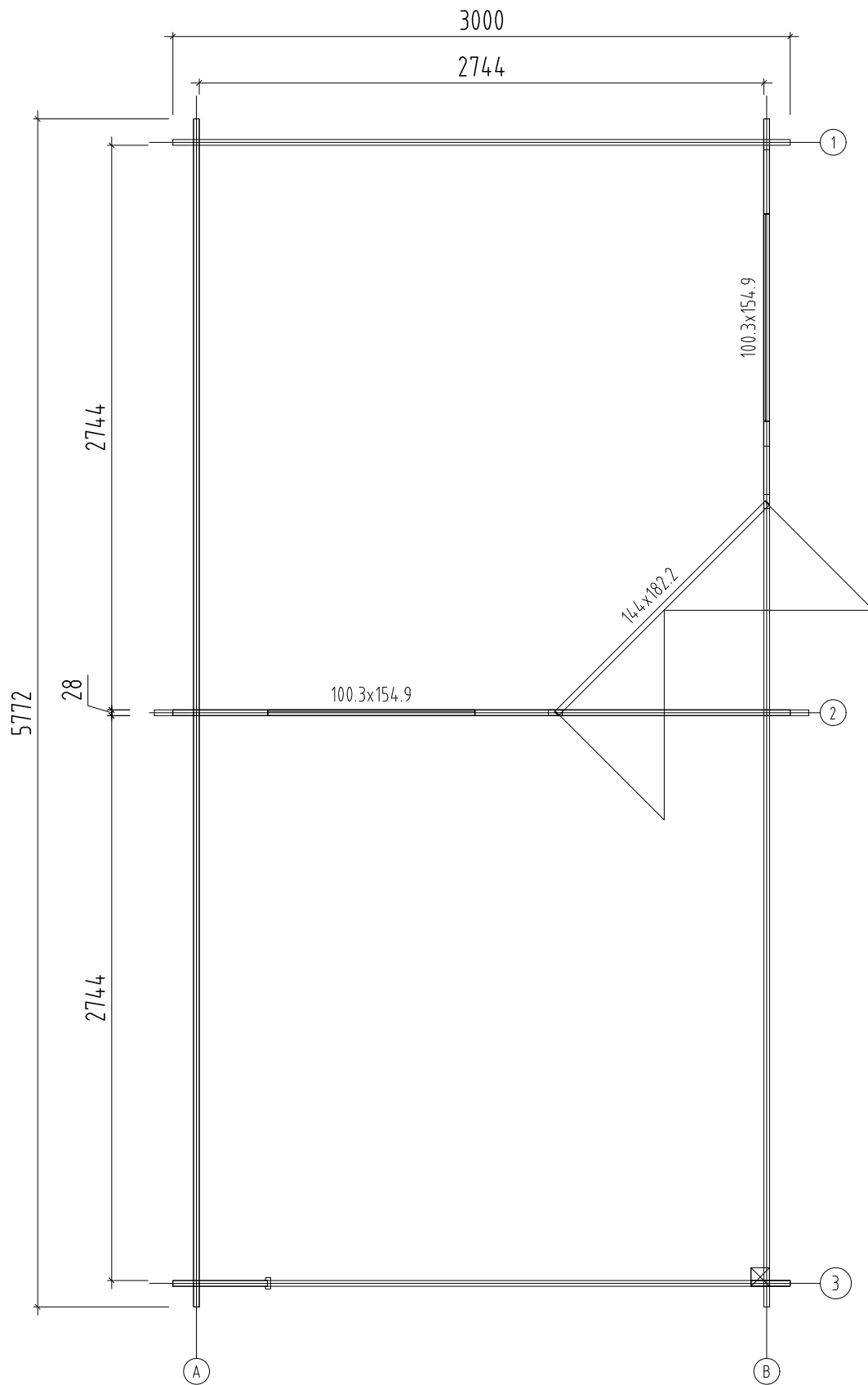

Plan a)

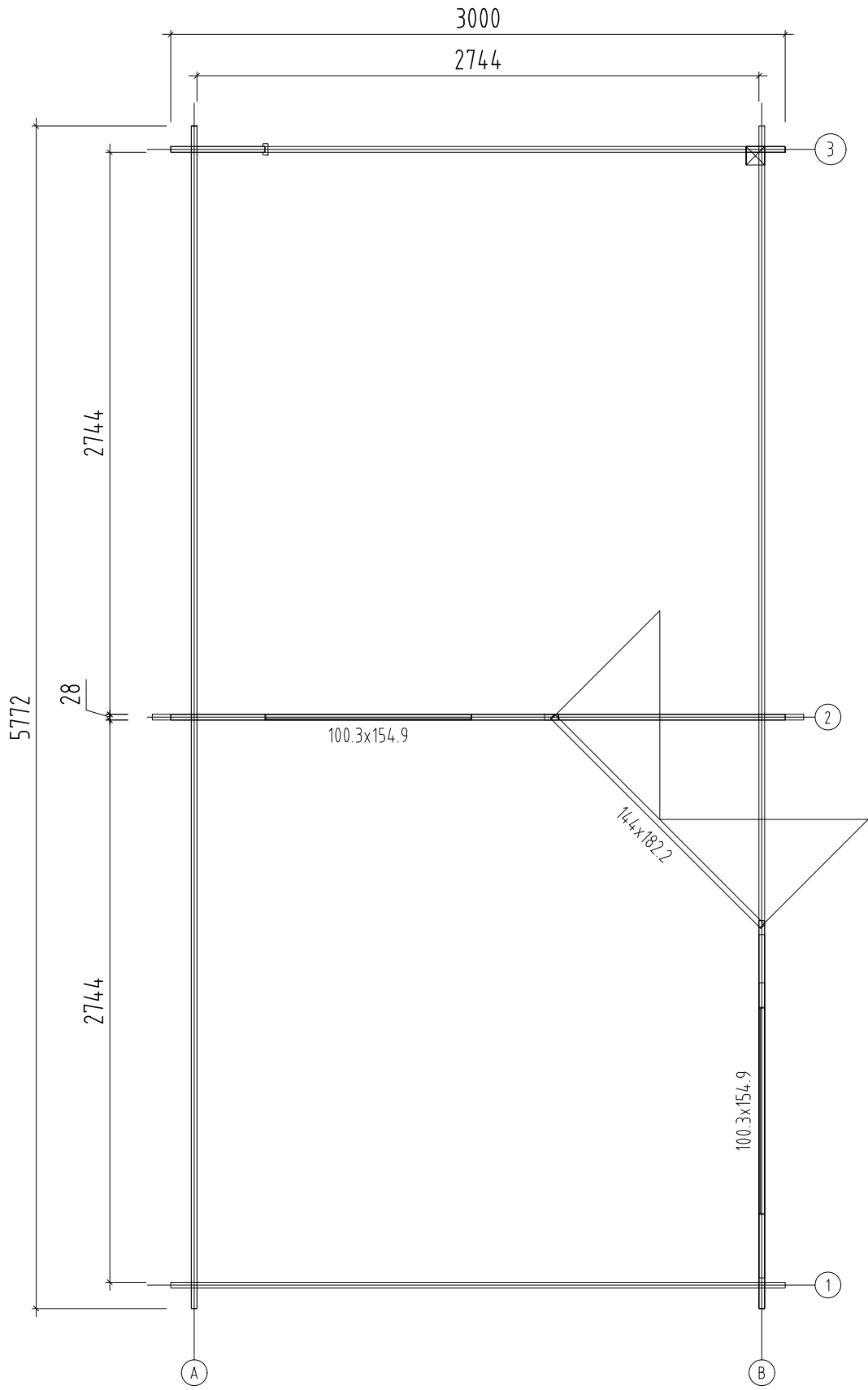

Plan b)

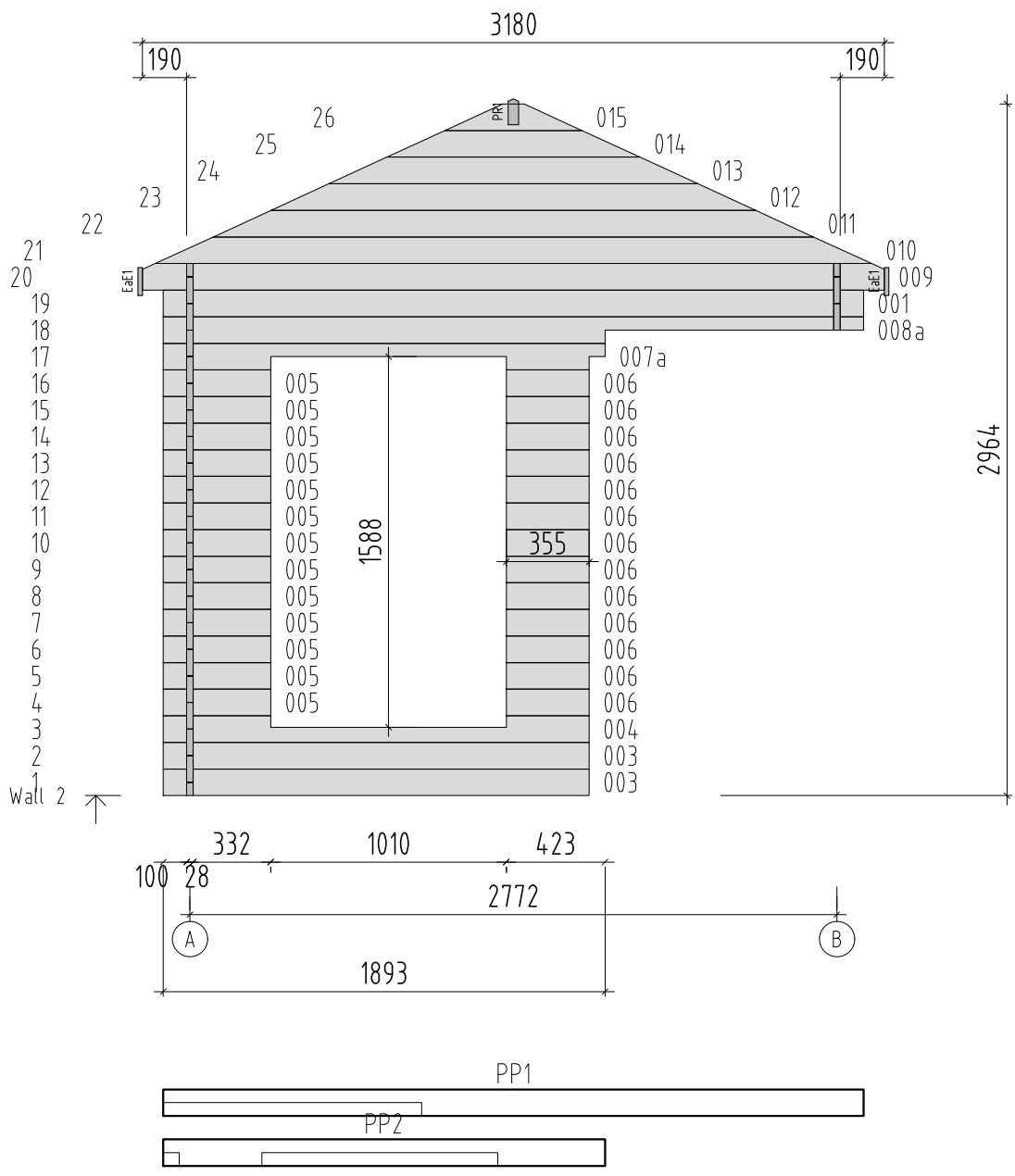

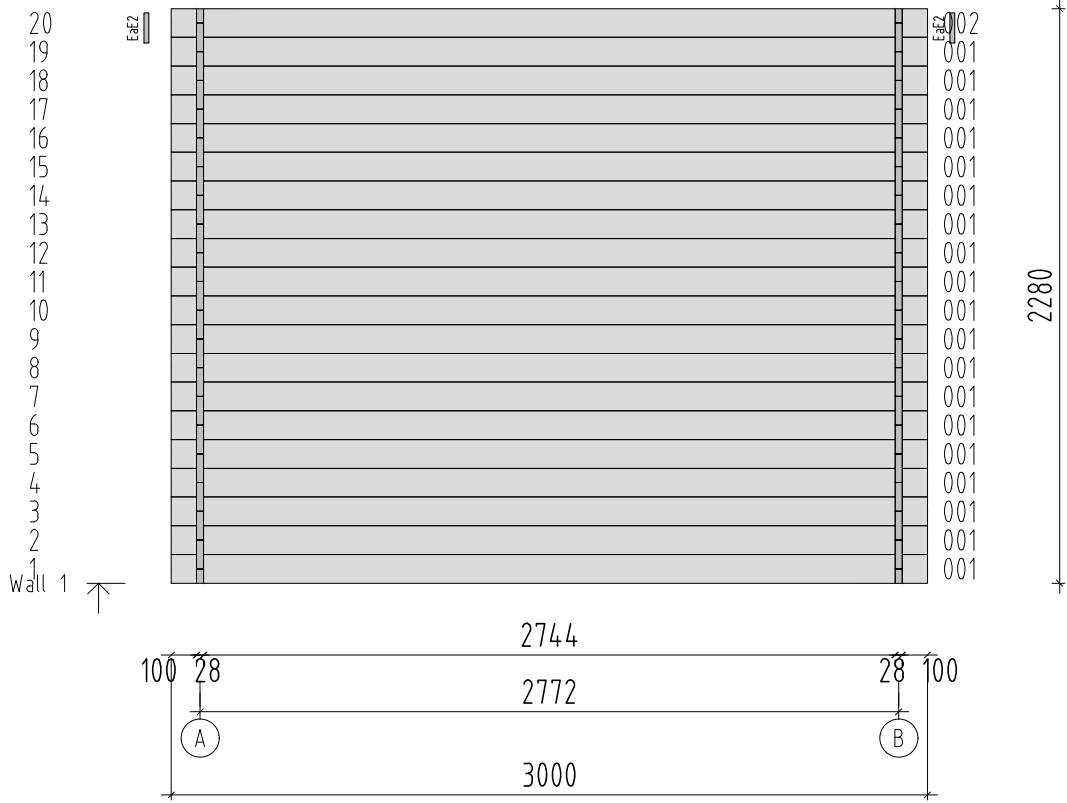

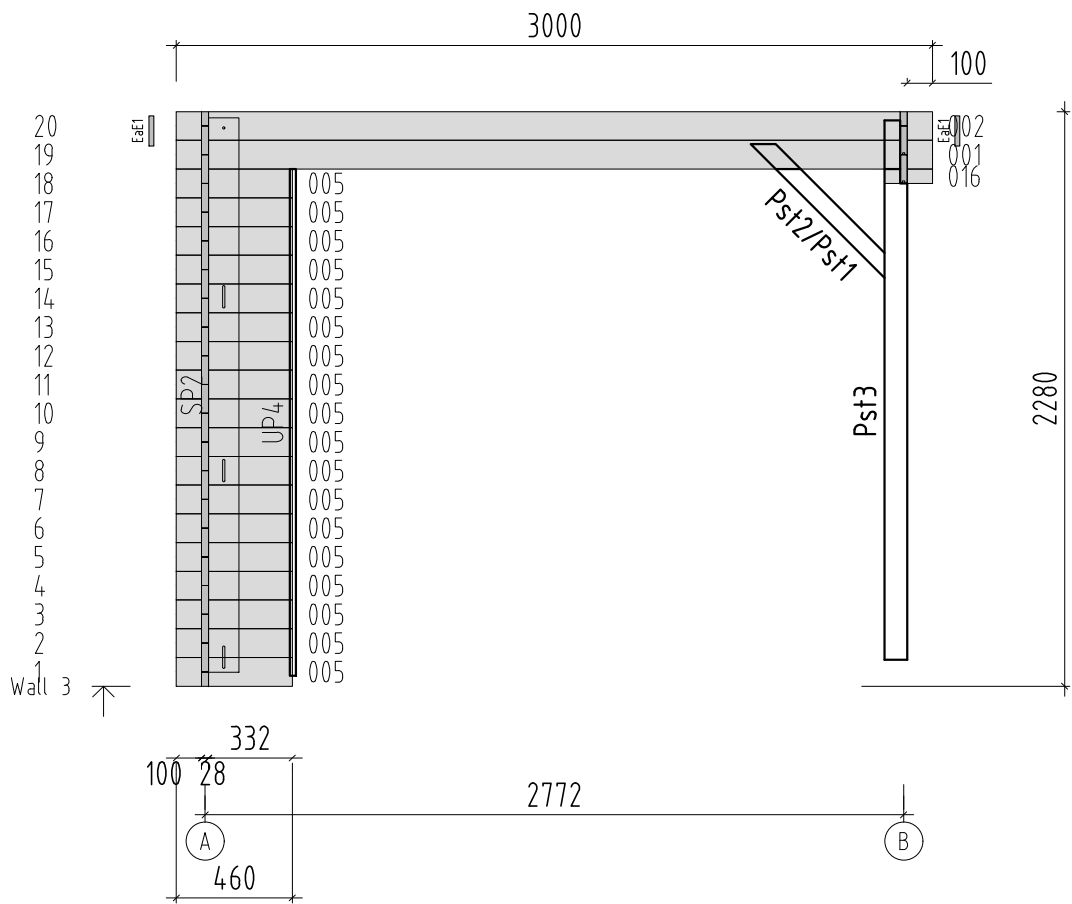

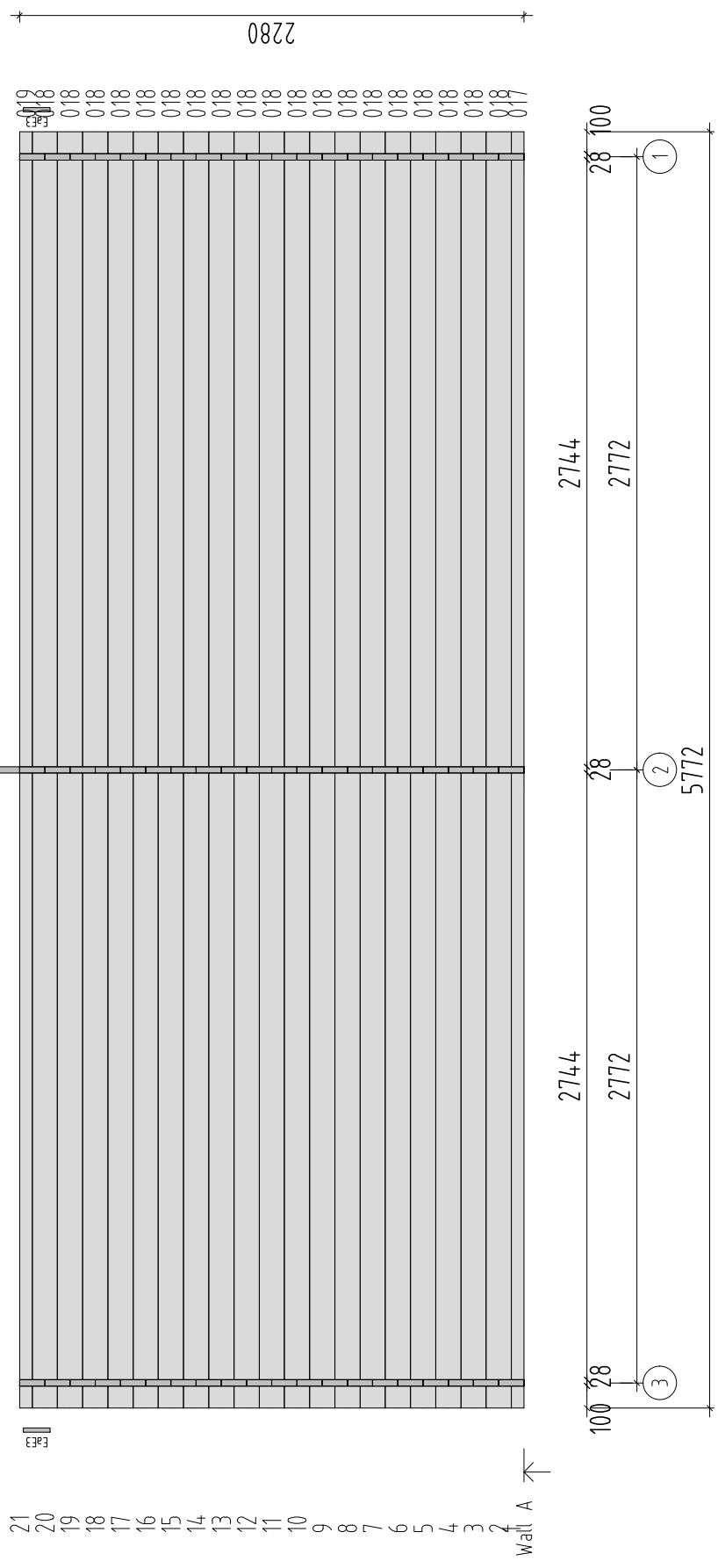

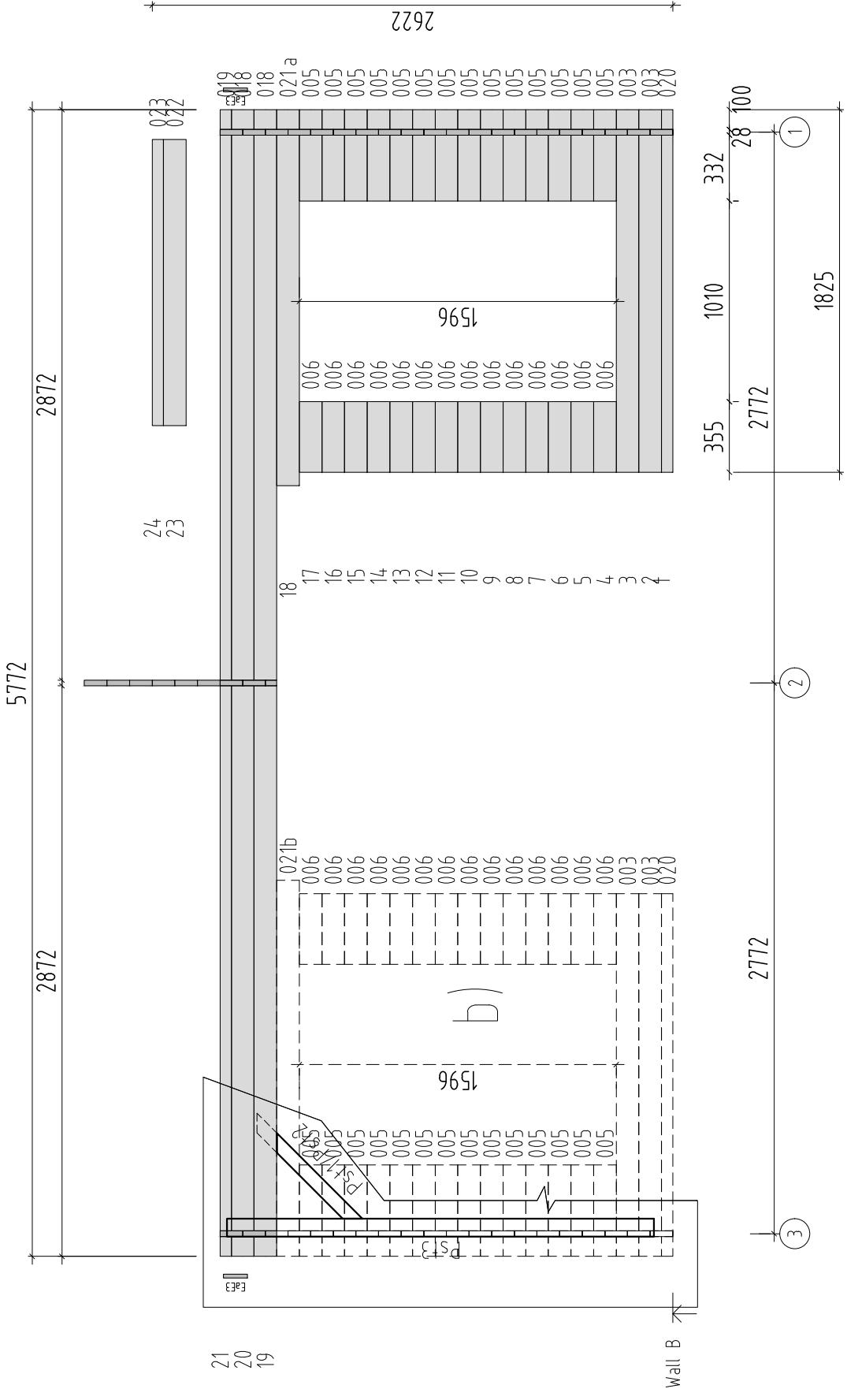

PP3



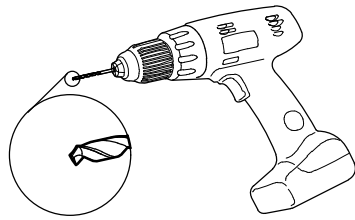

$\phi 3 \text{ mm}$

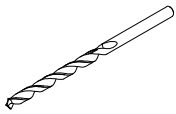

$\phi 5 \text{ mm}$

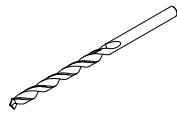

$\phi 8 \text{ mm}$

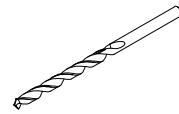

$\phi 4,5 - \phi 6$

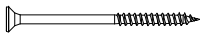

$\phi 8$

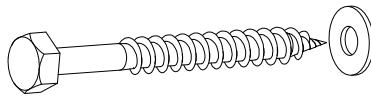

M8

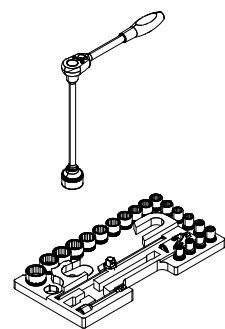
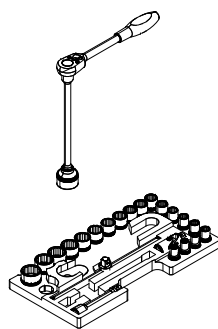
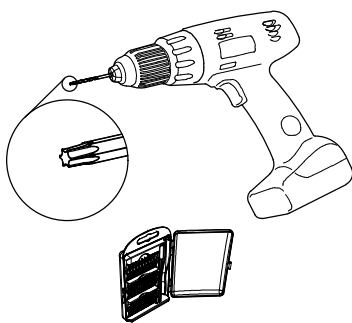
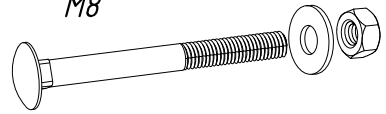

a)

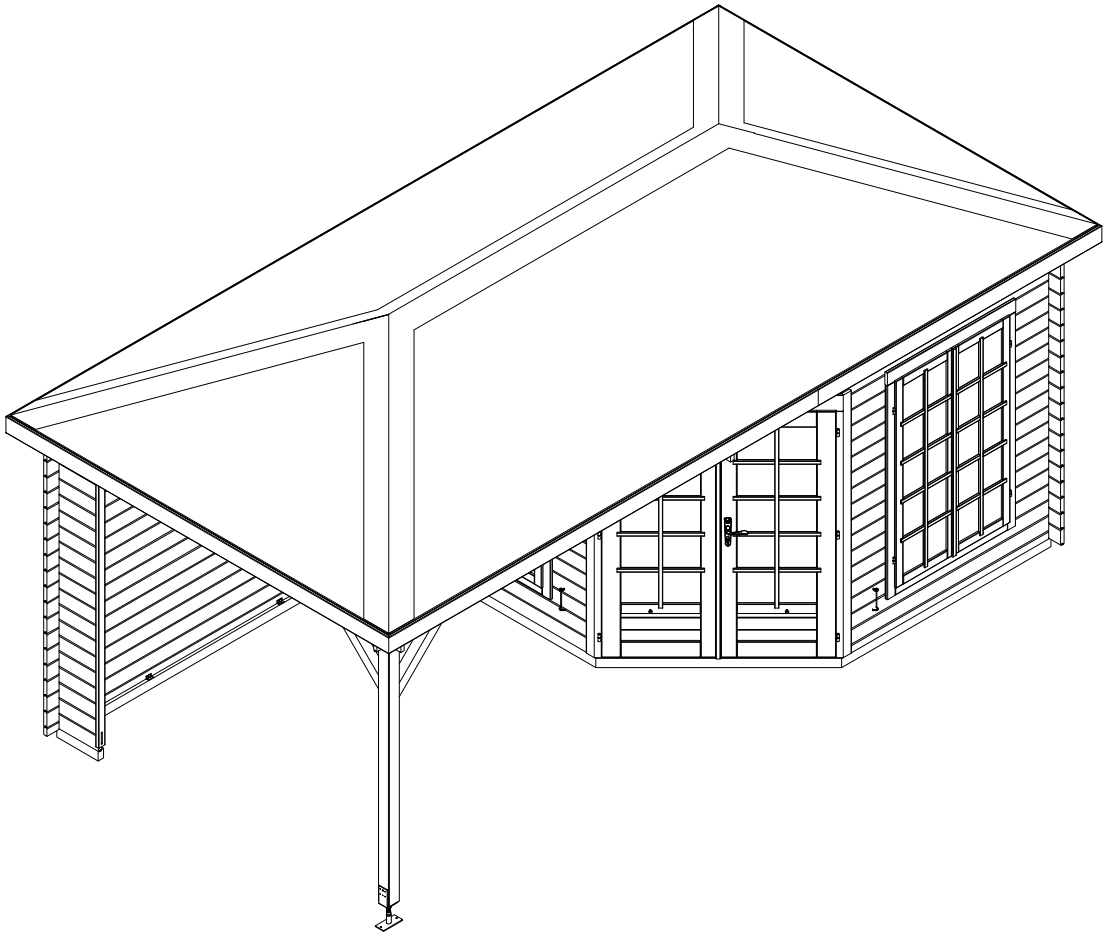

b)

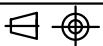
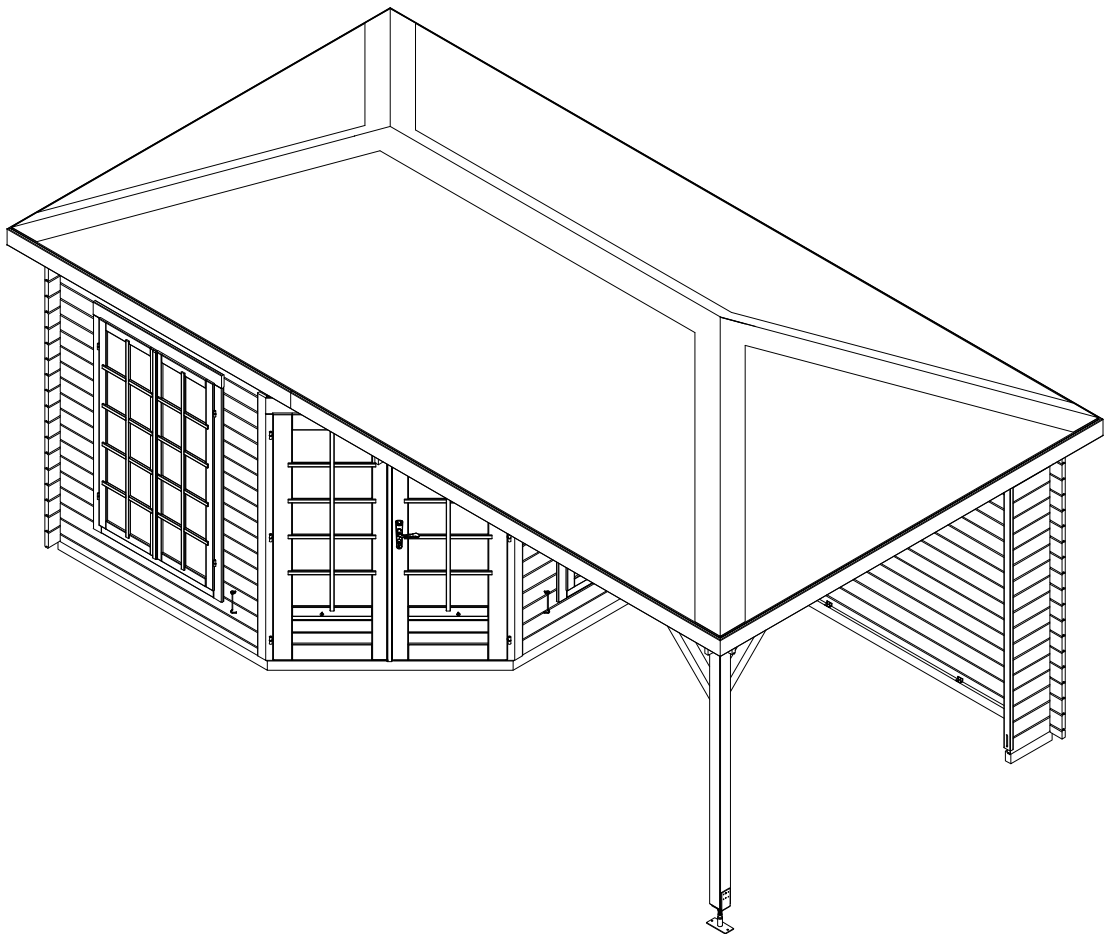

a)

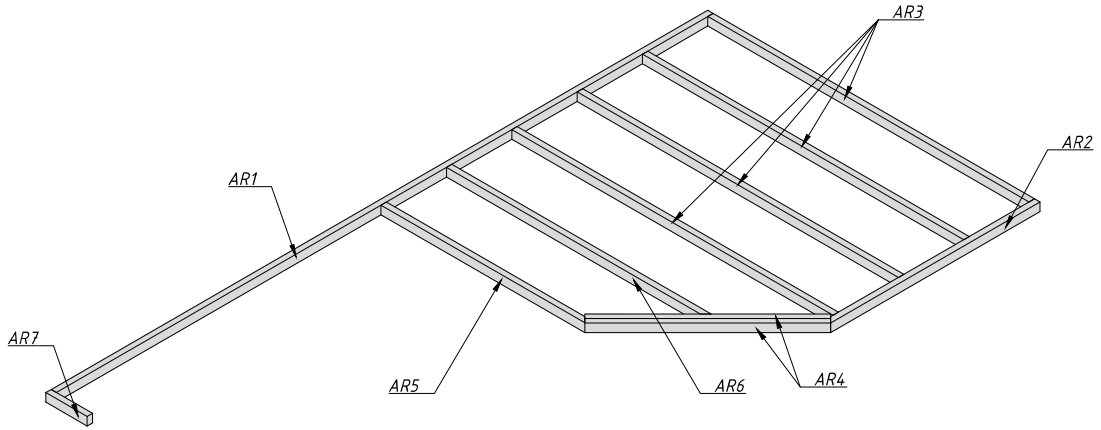

a)

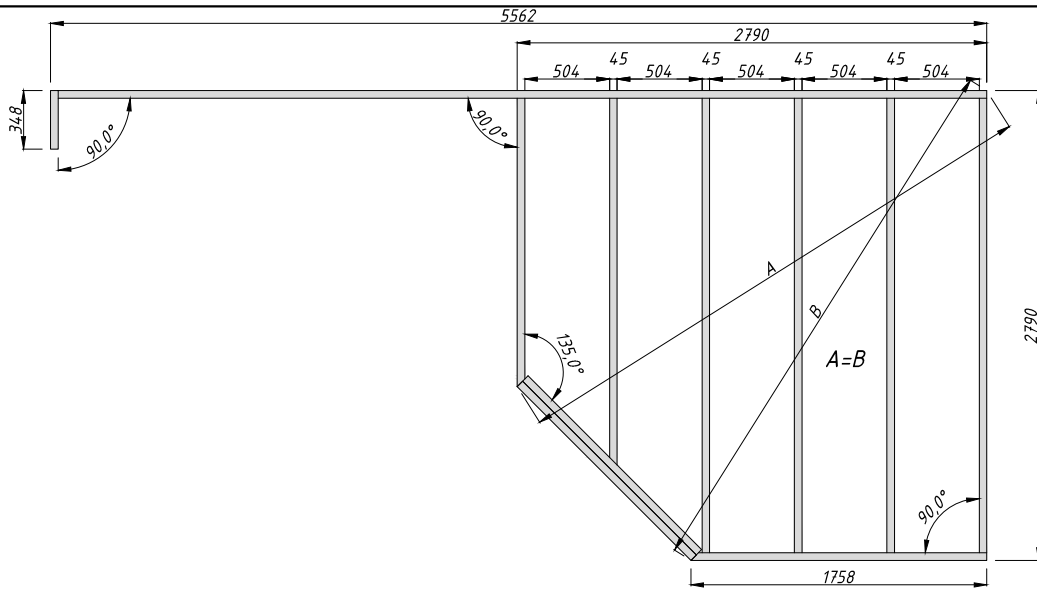

b)

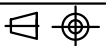
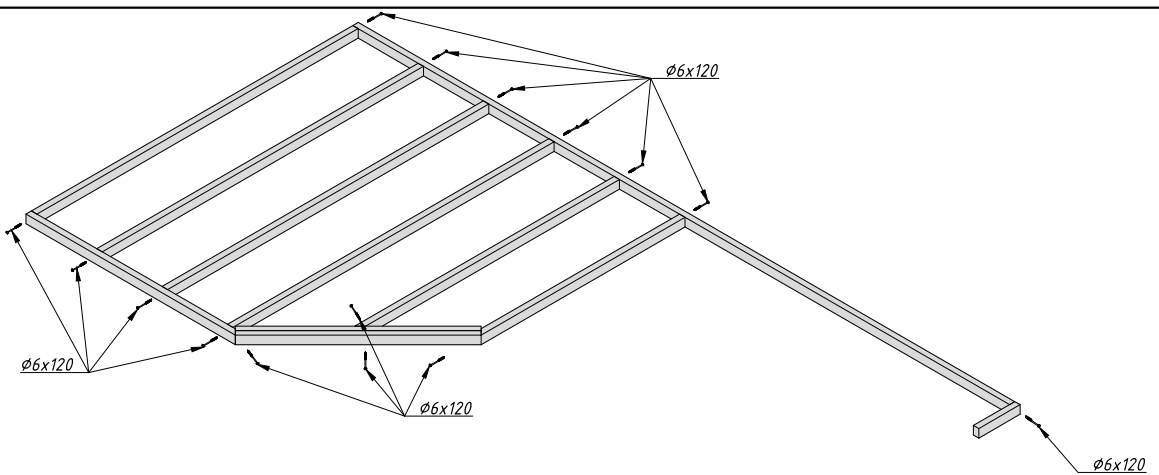

a)

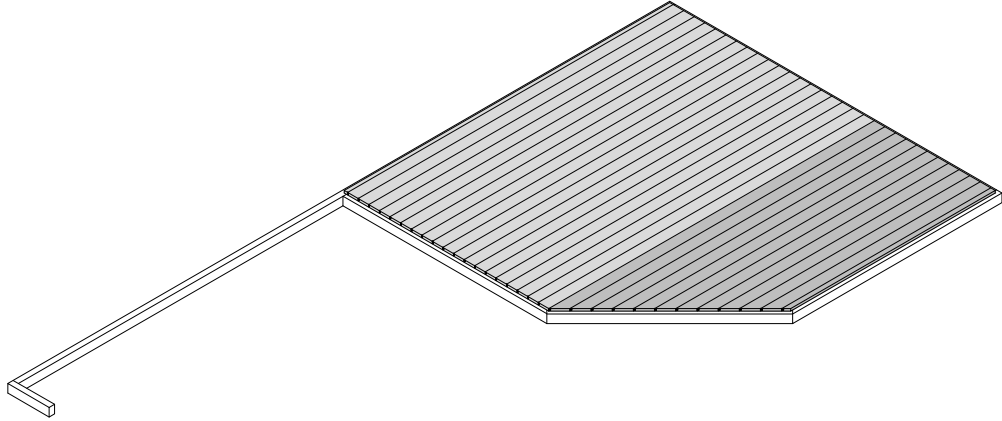

a)

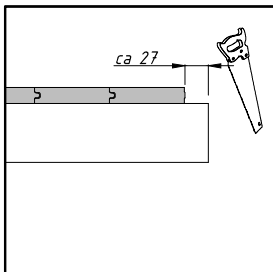
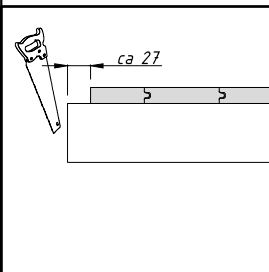
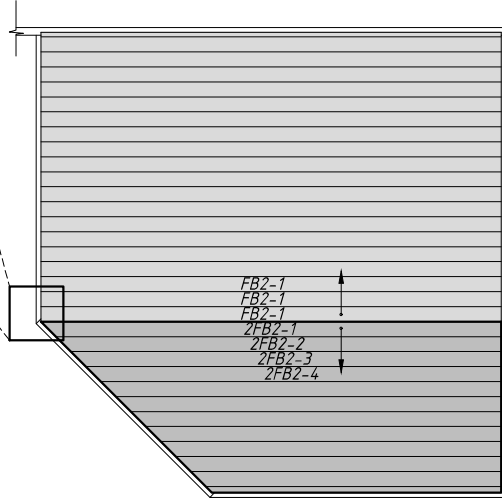
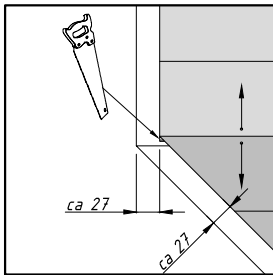
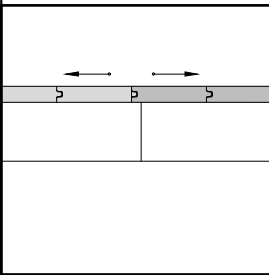

b)

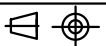
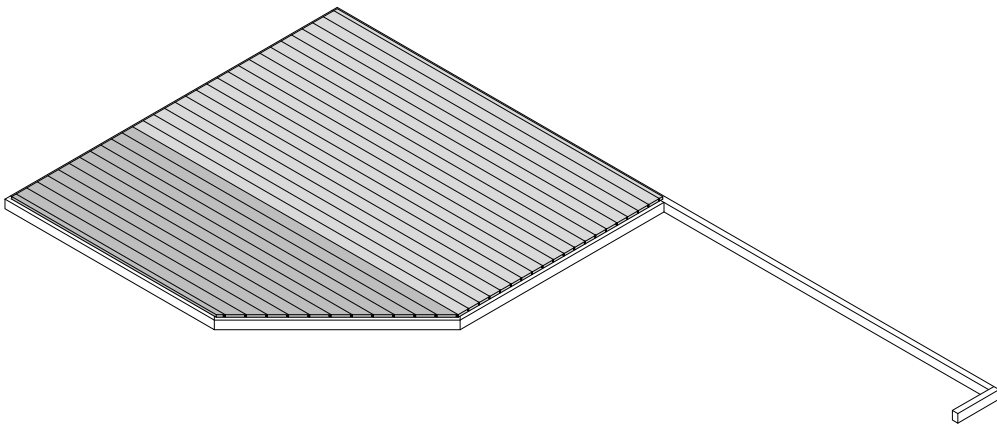

a)

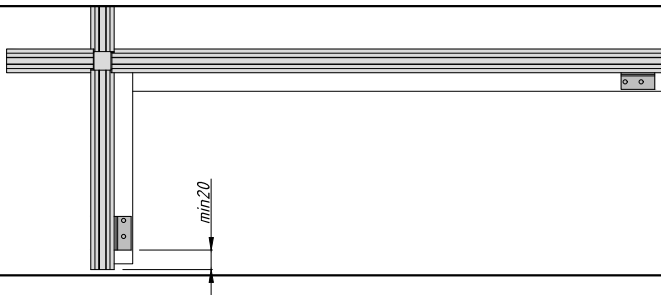
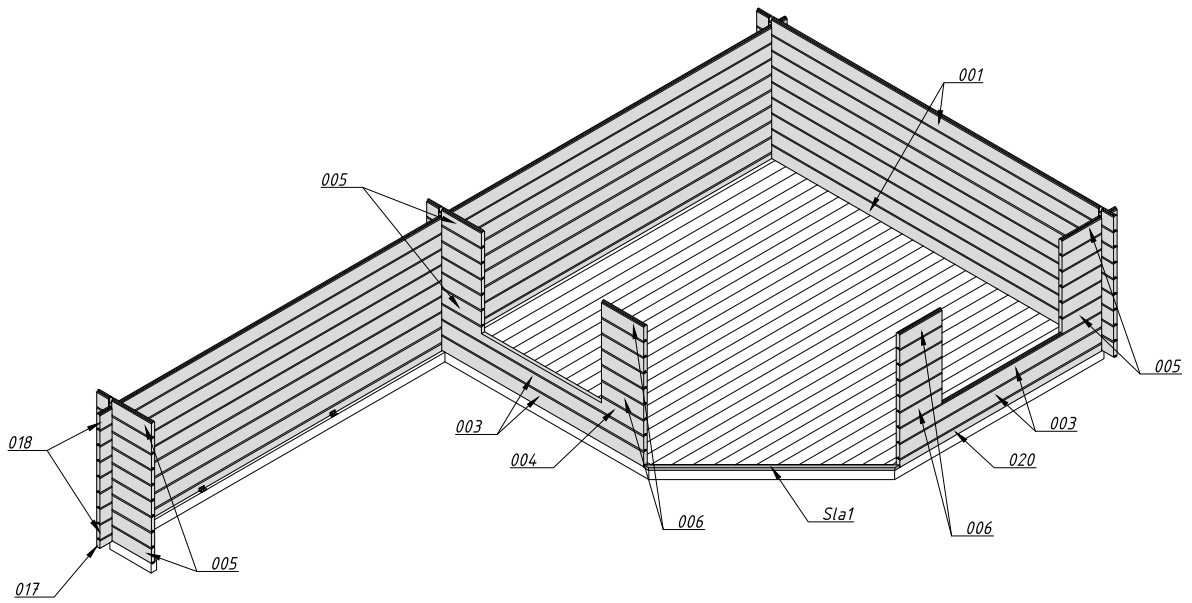

b)

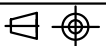
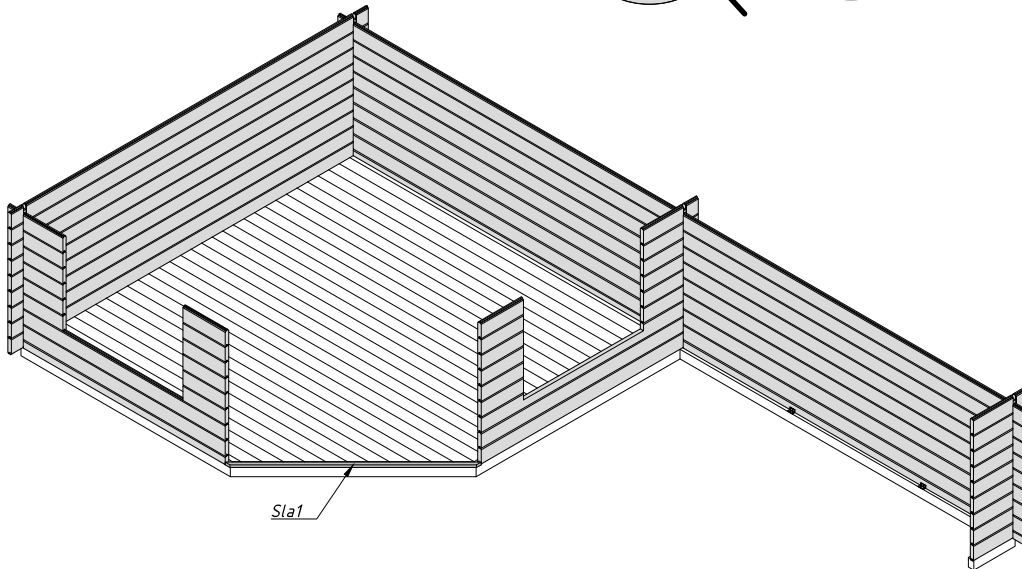
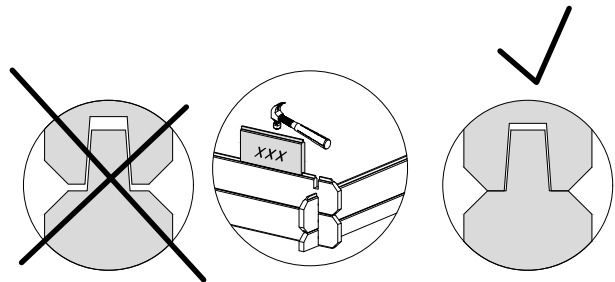

a)

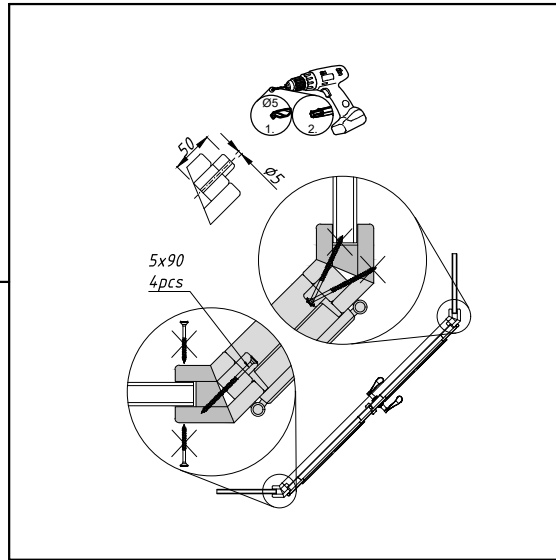
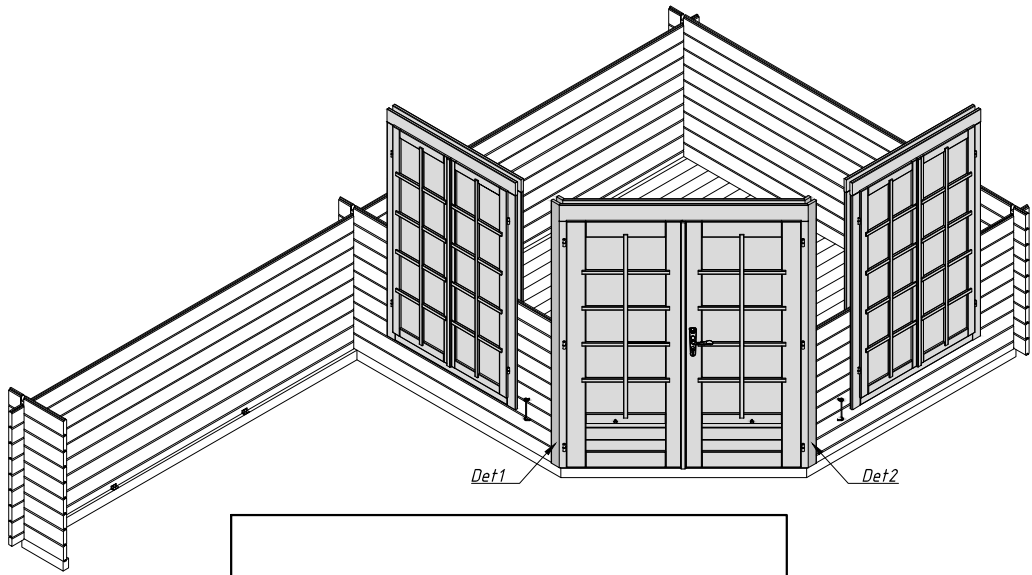

b)

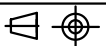
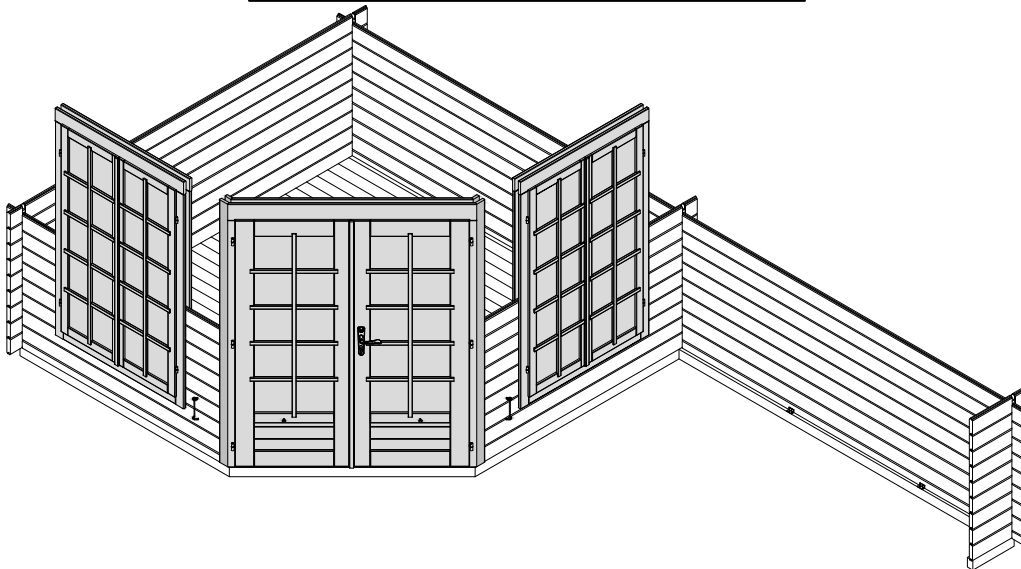

a)

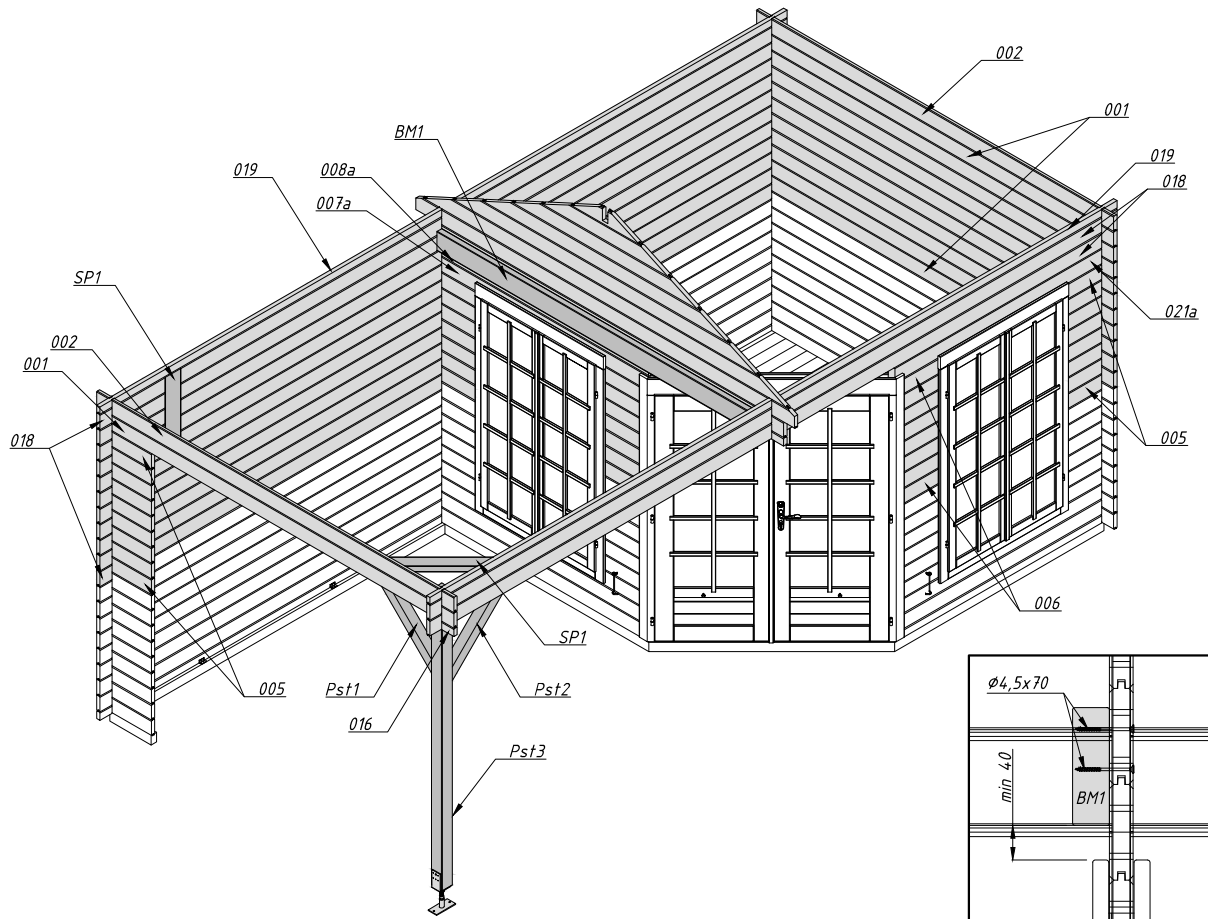

b)

