

Assembly, installation and maintenance manual

Montage-, Aufbau- und Wartungsanleitung • Assemblage, manuel de montage et d'entretien • Montaje, instalación y mantenimiento • Manuale di montaggio, installazione e manutenzione • Monterings- og vedlikeholdsmanual • Monterings-, installations- och underhållsmanual • Kokoamis-, asennus- ja huolto-ohje • Vejledning for montering og vedligehold • Handleiding voor montage, installatie en onderhoud • Manual de montagem, instalação e manutenção • Návod k montáži, instalaci a údržbě • Instrukcja montażu, instalacji i konserwacji • Surinkimo, montavimo ir priežiūros vadovas • Montāžas, uzstādīšanas un apkopes rokasgrāmata • Руководство по сборке и обслуживанию • Montaaži-, paigaldus- ja säilitamise juhend













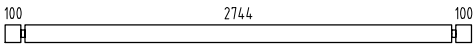
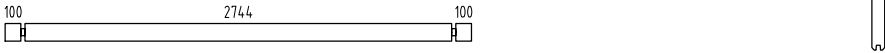
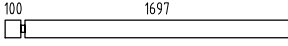
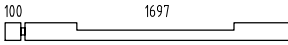

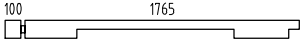
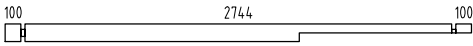
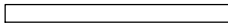

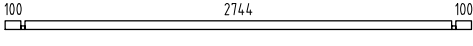
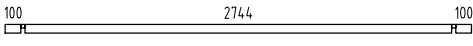
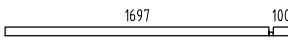
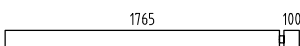
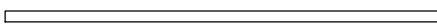
Pavilion **PA28-3030**

Treatment options, Item code





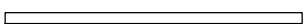



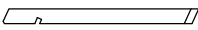
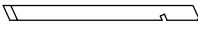

• Behandlungsoptionen, Artikel-Code • Traitement options, code de l'article • Opciones de tratamiento, código del artículo • Opzioni di trattamento, codice articolo • Behandlingsalternativer, artikkelnummer • Behandlingsalternativ, varukod • Käsittelevaihtoehdot, yksikön koodi • Behandlingsmuligheder, artikel nummer • Behandlingsopties, artikelnummer • Opções de tratamento, código do artigo • Povrchové úpravy, kód položky • Możliwości leczenia, kod produktu • Apdorojimo variantai, prekės kodas • Apstrādes iespējas, artikula kods • Варианты обработки, код изделия • Tõõtlusvõimalused, tootekood



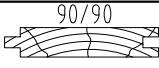
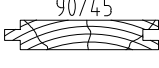
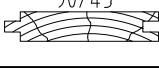

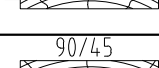
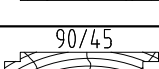
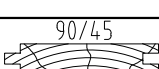
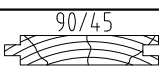
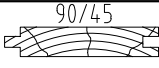
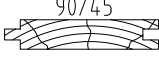

NO 109013
BNDIP 103709
GYDIP 103711
WTDIP 103710

<p>Factory inspection by • Werkskontrolle durch • Contrôle à partir de l'usine par • Inspector de fábrica • Collaudato da • Fabrikkkontroll utført av • Fabriksbesiktigat av • Tehtaan tarkastaja • Fabriks Kontrol udført af • Fabrikscontrole door • Inspeção de fábrica, por: • Zkontrolováno ve výrobním závodě • Kontrola fabryczna do • Apžiūrą gamykloje atliko • Rūpnīcas pārbaudi veicis • Заводской контроль • Tehase kontroll teostatud:</p> <p>.....</p>	<p>Date • Datum • Date • Fecha • Data • Dato • Datum • Päiväys • Dato • Datum • Data • Datum • Data • Datums • Data • Дата • Kuupäev:</p> <hr/> <p>Pack number • Pack Nr. • Packet n° • Bulto N° • Pacco N. • Serienr • Produktionsnummer • Pakettinro • Pakke nr. • Pak nr. • Número de embalagem • Číslo balení • Numer opakowania • Pakuotės numeris • Iepakojuma numurs • Упаковочный номер • Pakinumber:</p>
---	---

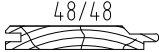
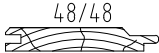
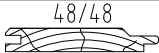
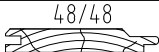

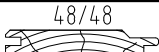
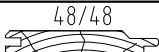
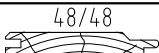
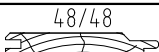
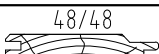
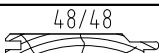
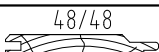
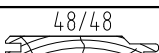
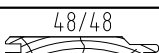
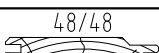
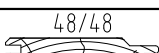
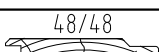
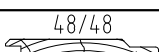
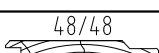
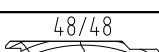





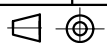

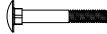
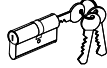





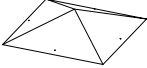

Pos	SPECIFICATION-STÜCKLISTE-NOMENCLATURE-ELEMENTI-ESPECIFICACIÓN PA28-3030	Pcs	Profile (mm)	Length (mm)
001		37	28x114	3000
002		2	28x114	3000
003		4	28x114	1825
004		1	28x114	1825
005		27	28x114	460
006		27	28x114	352
007		1	28x114	1893
008		1	28x114	3000
009		1	28x114	1440
010		1	28x57	1440
011		1	28x57	3000
012		2	28x57	3000
013		1	28x57	1825
014		1	28x114	1893
AR4	Foundation- Fundament- Fondation- Fondazione- Vigas de cimentación 	1	45x70	2790
AR1	Foundation- Fundament- Fondation- Fondazione- Vigas de cimentación 	4	45x70	2700
AR2	Foundation- Fundament- Fondation- Fondazione- Vigas de cimentación 	1	45x70	2180
AR6	Foundation- Fundament- Fondation- Fondazione- Vigas de cimentación 	1	45x70	1758
AR3	Foundation- Fundament- Fondation- Fondazione- Vigas de cimentación 	1	45x70	1713
AR5	Foundation- Fundament- Fondation- Fondazione- Vigas de cimentación 	2	45x70	1460
Det1	Detail- Detail- Detail- Dettaglio- Detalle 	1	70x70	150
EaE1	Eave edging- Dachrandbrett- Madrier en bordure du toit- Tavola bordo tetto- Tabla de valadizo 	4	95x19	3220
Pst2	Post- Pfosten- Poteau- Montante- Poste 	1	70x70	1910
Pst1	Post- Pfosten- Poteau- Montante- Poste 	1	70x70	1910
RoR3	Rafter- Sparre- Chevron- Trave- Cabrio 	4	44x95	2350





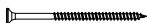

Pos	SPECIFICATION-STÜCKLISTE-NOMENCLATURE-ELEMENTI-ESPECIFICACIÓN PA28-3030	Pcs	Profile (mm)	Length (mm)
RoR2	Rafter- Sparre- Chevron- Trave- Cabrio 	4	44x95	1258
RoR1	Rafter- Sparre- Chevron- Trave- Cabrio 	4	44x95	1258
Sla1	Slat- Leiste- Baguette- Listello- Listón 	1	19x28	1520
UP1	U-profile board- U-Profileleiste- Baguette profilée en U- Listello profilo ad U- Listón de perfil U 	4	44x88	900
UP3	U-profile board- U-Profileleiste- Baguette profilée en U- Listello profilo ad U- Listón de perfil U 	4	44x88	878
UP2	U-profile board- U-Profileleiste- Baguette profilée en U- Listello profilo ad U- Listón de perfil U 	4	44x88	878
FB2-1	Floor board- Fussbodenbrett- Madrier du plancher - Tavola pavimento- Tabla de suelo 	20	89x19	2735
2FB2-1	Floor board- Fussbodenbrett- Madrier du plancher - Tavola pavimento- Tabla de suelo 2 	1	89x19	2735
2FB2-2	Floor board- Fussbodenbrett- Madrier du plancher - Tavola pavimento- Tabla de suelo 2 	1	89x19	2646
2FB2-3	Floor board- Fussbodenbrett- Madrier du plancher - Tavola pavimento- Tabla de suelo 2 	1	89x19	2557
2FB2-4	Floor board- Fussbodenbrett- Madrier du plancher - Tavola pavimento- Tabla de suelo 2 	1	89x19	2468
2FB2-5	Floor board- Fussbodenbrett- Madrier du plancher - Tavola pavimento- Tabla de suelo 2 	1	89x19	2379
2FB2-6	Floor board- Fussbodenbrett- Madrier du plancher - Tavola pavimento- Tabla de suelo 2 	1	89x19	2290
2FB2-7	Floor board- Fussbodenbrett- Madrier du plancher - Tavola pavimento- Tabla de suelo 2 	1	89x19	2201
2FB2-8	Floor board- Fussbodenbrett- Madrier du plancher - Tavola pavimento- Tabla de suelo 2 	1	89x19	2112
2FB2-9	Floor board- Fussbodenbrett- Madrier du plancher - Tavola pavimento- Tabla de suelo 2 	1	89x19	2023
2FB2-10	Floor board- Fussbodenbrett- Madrier du plancher - Tavola pavimento- Tabla de suelo 2 	1	89x19	1934
2FB2-11	Floor board- Fussbodenbrett- Madrier du plancher - Tavola pavimento- Tabla de suelo 2 	1	89x19	1845
2FB2-12	Floor board- Fussbodenbrett- Madrier du plancher - Tavola pavimento- Tabla de suelo 2 	1	89x19	1756

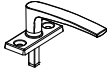
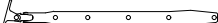
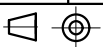
Pos	SPECIFICATION-STÜCKLISTE-NOMENCLATURE-ELEMENTI-ESPECIFICACIÓN PA28-3030	Pcs	Profile (mm)	Length (mm)
RB1-1	Roof board- Dachbrett- Madrier du toit- Tavola tetto- Tabla de tejado 	4	89x16	3170
RB1-2	Roof board- Dachbrett- Madrier du toit- Tavola tetto- Tabla de tejado 	4	89x16	3008
RB1-3	Roof board- Dachbrett- Madrier du toit- Tavola tetto- Tabla de tejado 	4	89x16	2847
RB1-4	Roof board- Dachbrett- Madrier du toit- Tavola tetto- Tabla de tejado 	4	89x16	2684
RB1-5	Roof board- Dachbrett- Madrier du toit- Tavola tetto- Tabla de tejado 	4	89x16	2523
RB1-6	Roof board- Dachbrett- Madrier du toit- Tavola tetto- Tabla de tejado 	4	89x16	2361
RB1-7	Roof board- Dachbrett- Madrier du toit- Tavola tetto- Tabla de tejado 	4	89x16	2200
RB1-8	Roof board- Dachbrett- Madrier du toit- Tavola tetto- Tabla de tejado 	4	89x16	2035
RB1-9	Roof board- Dachbrett- Madrier du toit- Tavola tetto- Tabla de tejado 	4	89x16	1876
RB1-10	Roof board- Dachbrett- Madrier du toit- Tavola tetto- Tabla de tejado 	4	89x16	1714
RB1-11	Roof board- Dachbrett- Madrier du toit- Tavola tetto- Tabla de tejado 	4	89x16	1552
RB1-12	Roof board- Dachbrett- Madrier du toit- Tavola tetto- Tabla de tejado 	4	89x16	1390
RB1-13	Roof board- Dachbrett- Madrier du toit- Tavola tetto- Tabla de tejado 	4	89x16	1229
RB1-14	Roof board- Dachbrett- Madrier du toit- Tavola tetto- Tabla de tejado 	4	89x16	1067
RB1-15	Roof board- Dachbrett- Madrier du toit- Tavola tetto- Tabla de tejado 	4	89x16	906
RB1-16	Roof board- Dachbrett- Madrier du toit- Tavola tetto- Tabla de tejado 	4	89x16	743
RB1-17	Roof board- Dachbrett- Madrier du toit- Tavola tetto- Tabla de tejado 	4	89x16	582
RB1-18	Roof board- Dachbrett- Madrier du toit- Tavola tetto- Tabla de tejado 	4	89x16	420
RB1-19	Roof board- Dachbrett- Madrier du toit- Tavola tetto- Tabla de tejado 	4	89x16	258
RB1-20	Roof board- Dachbrett- Madrier du toit- Tavola tetto- Tabla de tejado 	4	89x16	97
FIB2-1	Floor beading- Fussbodenleiste- Baguette du plancher- Listello pavimento- Listón de suelo 	5	19x19	2744
Rel-1	Roof element- Dachelement- Panneau de toit- Elemento di tetto- Elemento tejado 	1		1385
StB1-1	Storm brace- Sturmleiste- Protection contre le vent- Antivento- Protector contra tormentas 	5	25x45	2150

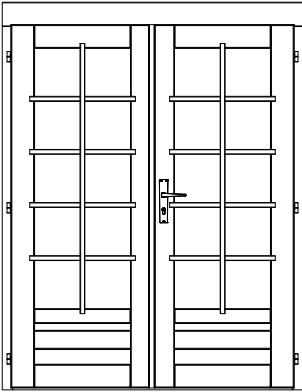

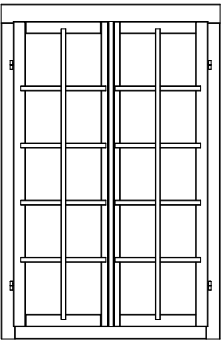
Pos	SPECIFICATION-STÜCKLISTE-NOMENCLATURE-ELEMENTI-ESPECIFICACIÓN PA28-3030	Pcs	
Fim	-Fixing kit- Befestigungsset- Moyens de fixation- Materiale di fissaggio- Kit de fijación	1	USE
QPOYP 8x60Zn	Bolt -Schloss-schraube -Boulon- Bullone- Perno- M8x60mm PUP0		10 StB1-1
QULSI 30x35	Cylinder- Zylinderschloss- Serrure a mortaiser- Serratura a cilindro- Bombin- 30.35		1 TU28-61P
QLIU KAPal	Door fittings- Türbeschlag- Ferrure- Ferramenta porta- Manilla puerta- QLIUKAPal		1 TU28-61P
QHA1 50Zn	Hook- Haken- Crochet- Ganzio- Pestillo QHA150Zn		2 TU28-61P+Wall
QRV1 20Zn	Keeper- Schliessblech- Tole- Lamiera- Aldaba de candado- 120Zn		1 TU28-61P
QNA1 4x40Me	Nail- Nagel- Clou- Chiodo- Clavo- 1.4x40mm		30 FIB2-1
QNA2 2x50Zn	Nail- Nagel- Clou- Chiodo- Clavo- 2.5x50mm		500 FB2-1; 2FB2-x; RB1-x
QNA4x 120Zn	Nail- Nagel- Clou- Chiodo- Clavo- 4x120mm		16 ARx
QMUk K8Zn	Nut- Schraubenmutter- Écrou- Dado- Tuerca- M8mm		10 
QK04	Roof cap- Dachkappe- Finition métallique- Finitura di tetto- Caballete de tejado- QK04		1
QKRPP2 5x16Zn	Screw- Schraube- Vis- Vite- Tornillo- 2.5x16mm Zn		2 
QKRPP3 5x50Zn	Screw- Schraube- Vis- Vite- Tornillo- 3.5x50mm		70 UP1; UP2; UP3 Rel-1; EaE1
QKRYp 3x16Zn	Screw- Schraube- Vis- Vite- Tornillo- 3x16mm ZnY		4 
QKRPP 3x20Zn	Screw- Schraube- Vis- Vite- Tornillo- 3x20mm		60 TU28-61P TA28-12P
QKRPP4 5x70Zn	Screw- Schraube- Vis- Vite- Tornillo- 4.5x70mm		22 003; 011; 012;
QKRPP 5x90Zn	Screw- Schraube- Vis- Vite- Tornillo- 5x90mm		50 TU28-61P RoRx
QSE8 x20Zn	Washer- Dichtscheibe- Joint- Rondella- Arandela- 8x20mm		10 
QLIA	Window fittings- Fenstergriff- Poigne de la fenêtre- Maniglia finestra- Manilla (ventana)		4 TA28-12P
QFK2 40Zn	Window stop- Fensterfeststelle- Crémaillère- Fissativo finestra- Fijador de ventana- QFK240Zn		4 TA28-12P
	Object name PA28-3030		Page 4/5

Pos	SPECIFICATION-STÜCKLISTE-NOMENCLATURE-ELEMENTI-ESPECIFICACIÓN PA28-3030	Pcs	Profile (mm)	Length (mm)
TU28 -61P	<p>Door - Tür - Porte - Porta-Puerta 1440x1822</p>   <p>1340x1752mm</p>	1		
TA28 -12P	<p>Window - Fenster - Fenetre - Finestra-Ventana 1003x1549</p>   <p>903x1449mm</p>	2		

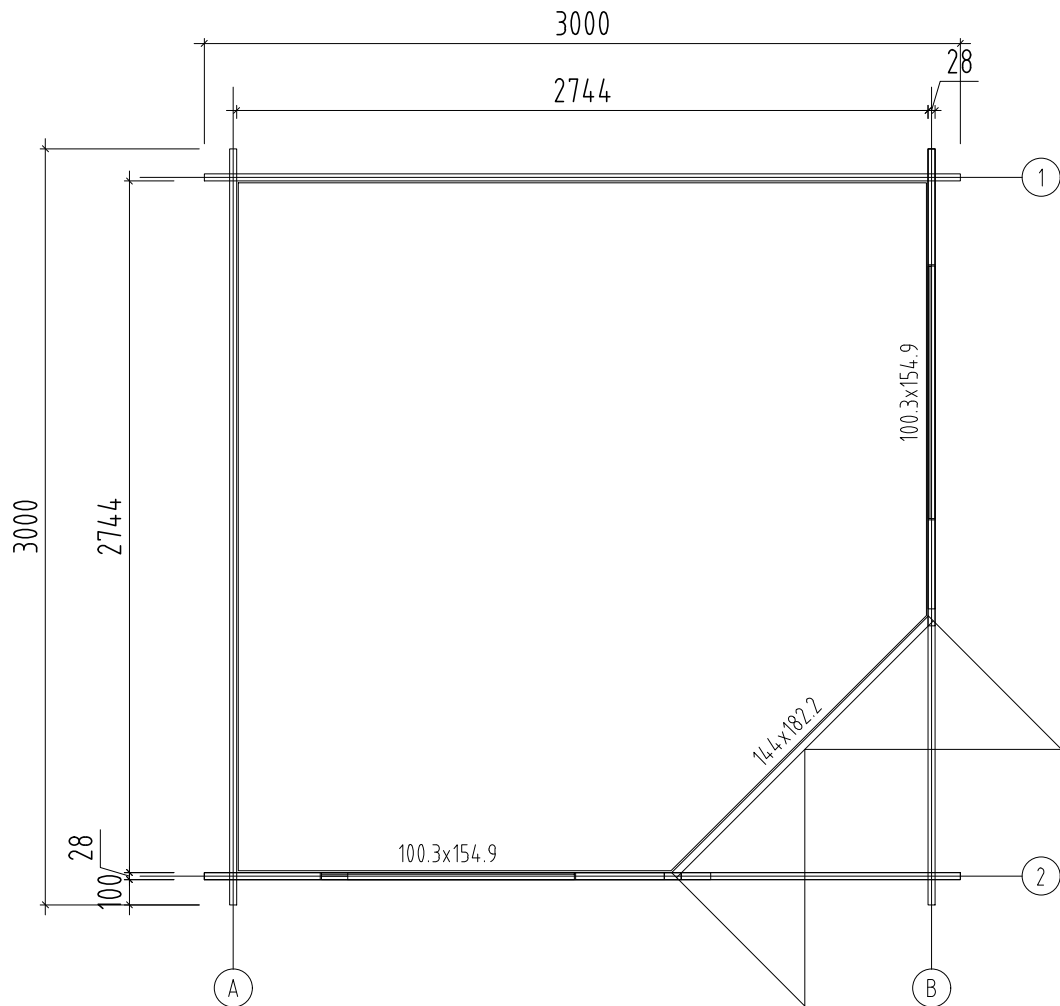

Object name PA28-3030	Drawing Plan	Scale 1:30	
		Paper A4	
Palmako <small>LEMEXS GROUP</small> AS Palmako <small>Näituse 25, Tartu 50409, Estonia tel. +372 73 55 530 fax. +372 73 55 544 www.palmako.com</small>	Customer	Log	28x114
	Drawn by	350	
	Date	03.12.2021	File: Melanie 7.0 m2.dwg

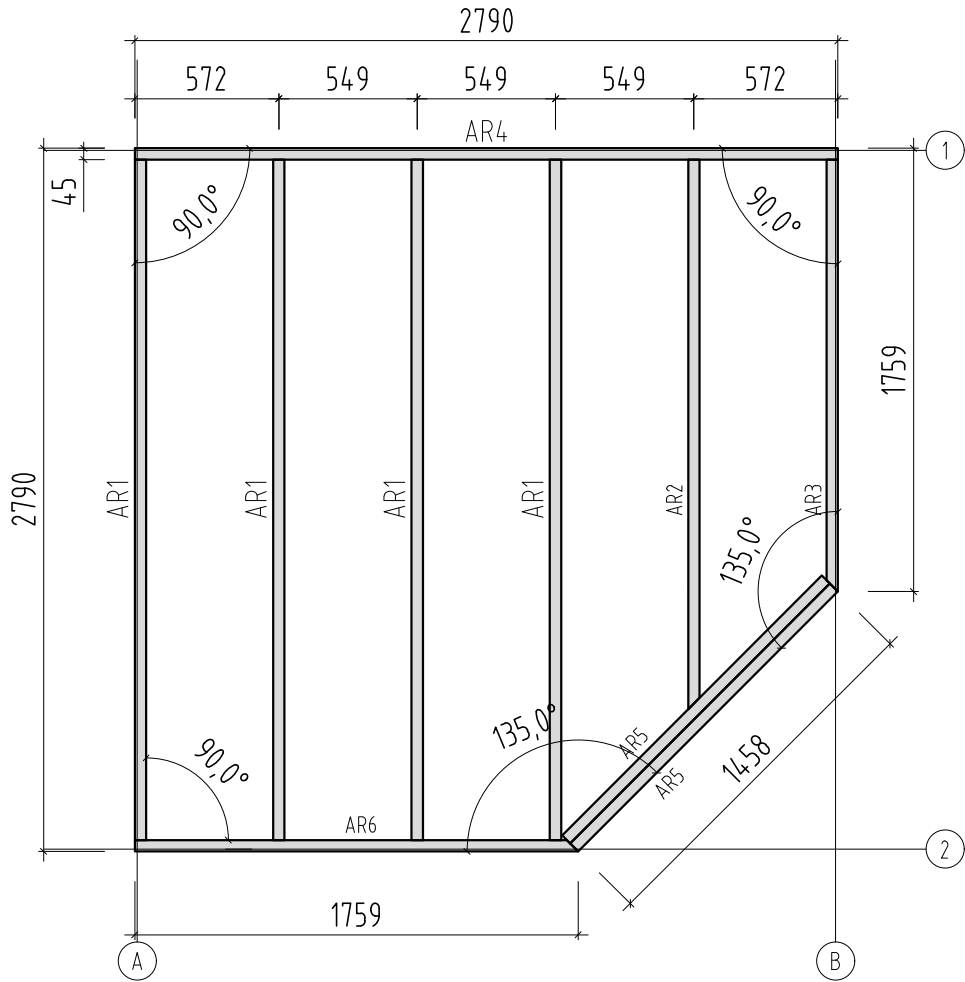

Object name
PA28-3030

Drawing
Plan (AR)

Scale 1:30

Paper A4

Palmako
LEMEKS GROUP

AS Palmako
Näituse 25, Tartu 50409, Estonia
tel. +372 73 55 530
fax. +372 73 55 544
www.palmako.com

Customer

Drawn by

Date

350

02.12.2021

Log

28x114

File Melanie 7.0 m2.dwg

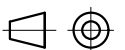

Page 1

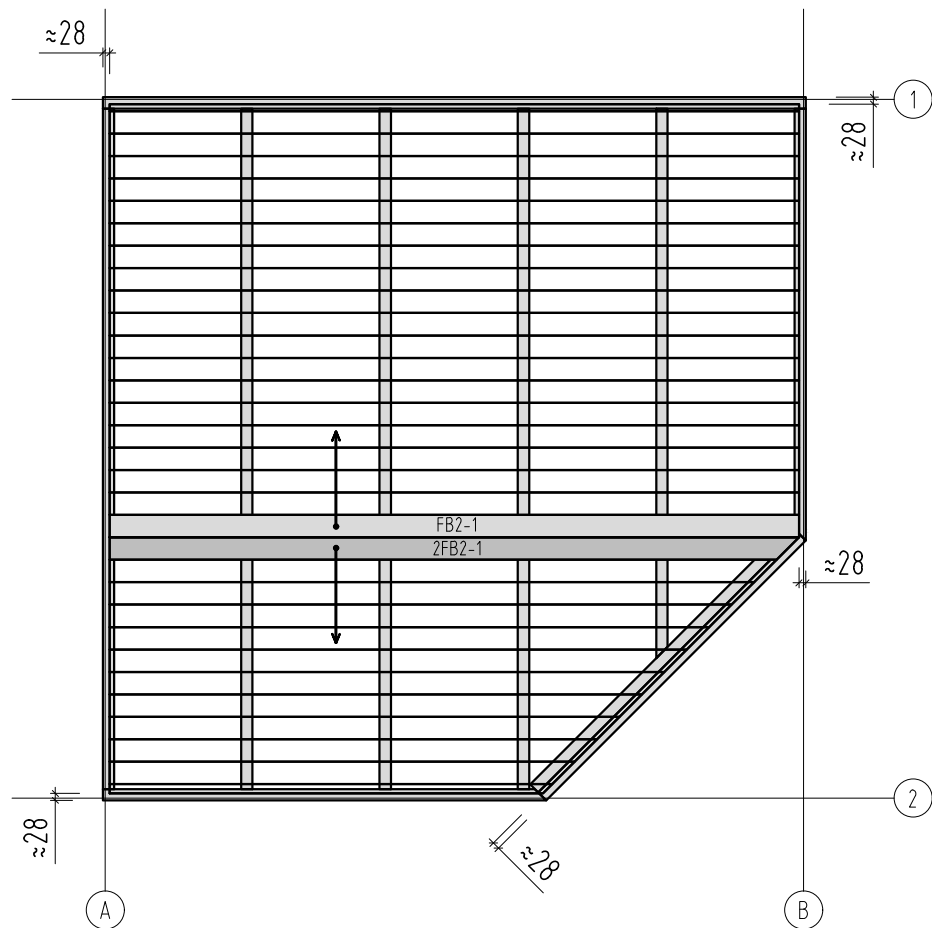

Object name PA28-3030	Drawing Plan		Scale 1:30
			Paper A4
Palmako <small>LEMEXS GROUP</small>	Customer	Log	
	AS Palmako Näituse 25, Tartu 50409, Estonia tel. +372 73 55 530 fax. +372 73 55 544 www.palmako.com	28x114	
	Drawn by 350		
	Date 03.12.2021	File Melanie 7.0 m2.dwg	Page 1

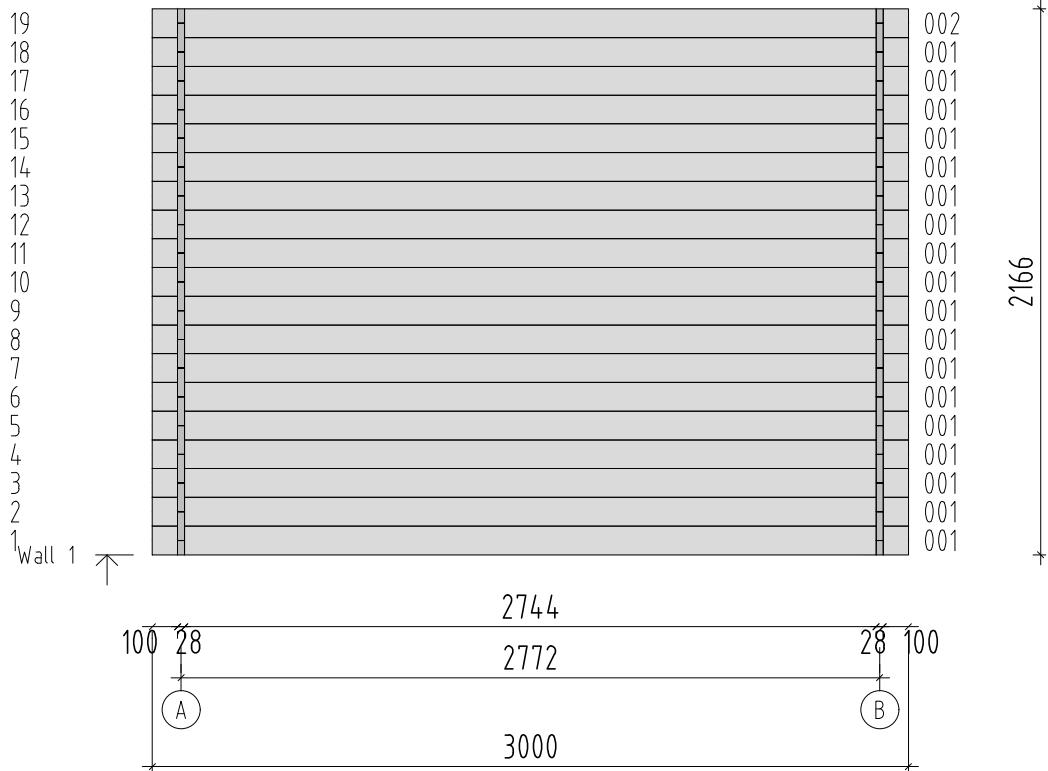

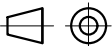
Object name PA28-3030	Drawing WALL 1	Scale 1:30	
		Paper A4	
Palmako <small>LEMEXS GROUP</small>	Customer	Log	28x114
	Drawn by	350	
	Date	02.12.2021	File Melanie 7.0 m2.dwg
<small>Näituse 25, Tartu 50409, Estonia tel. +372 73 55 530 fax. +372 73 55 544 www.palmako.com</small>			
		Page	4

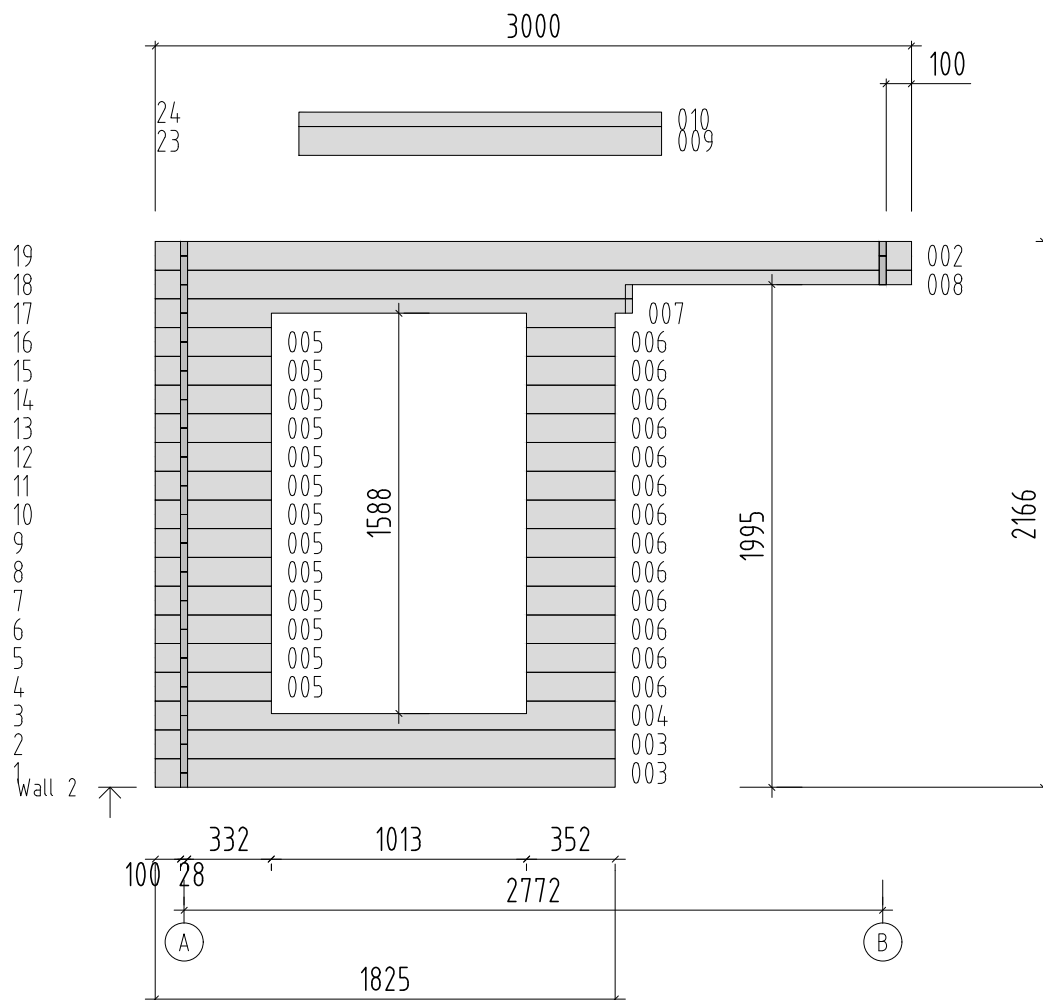

Object name PA28-3030	Drawing WALL 2	Scale 1:30
		Paper A4
Palmako AS Palmako Näituse 25, Tartu 50409, Estonia tel. +372 73 55 530 fax. +372 73 55 544 www.palmako.com LEMEKS GROUP	Customer	Log 28x114
	Drawn by 350	
	Date 02.12.2021	File Melanie 7.0 m2.dwg
		Page 5

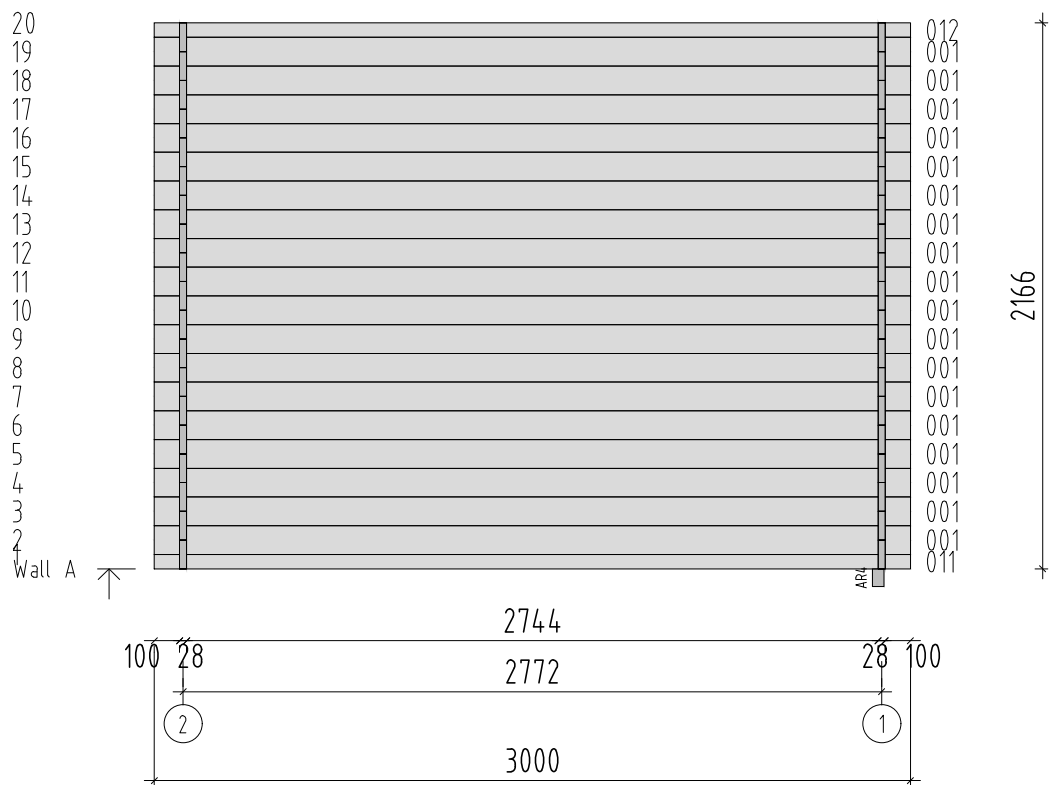

Object name PA28-3030	Drawing WALL A	Scale	1:30
		Paper	A4
Palmako <small>LEMEXS GROUP</small>	Customer	Log	28x114
	AS Palmako Näituse 25, Tartu 50409, Estonia tel. +372 73 55 530 fax. +372 73 55 544 www.palmako.com	Drawn by	350
	Date	02.12.2021	File Melanie 7.0 m2.dwg
			Page 2

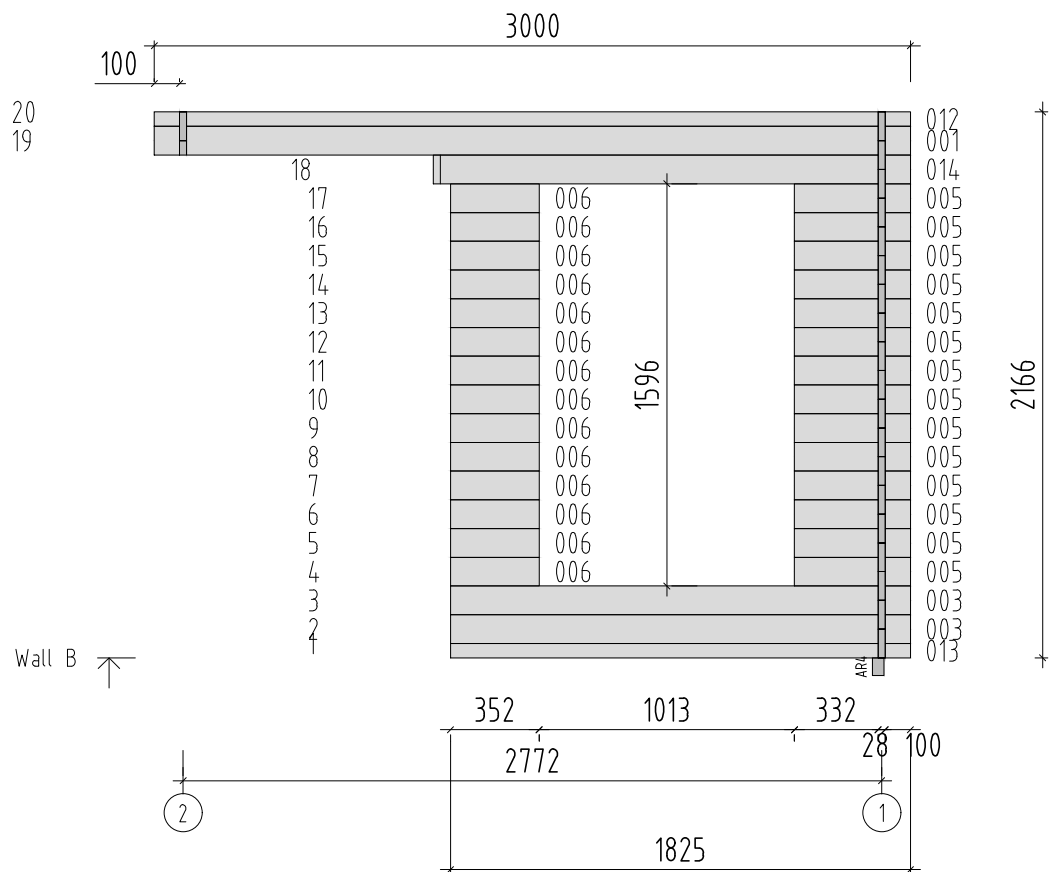

Object name PA28-3030	Drawing WALL B	Scale 1:30
		Paper A4
Palmako AS Palmako Näituse 25, Tartu 50409, Estonia tel. +372 73 55 530 fax. +372 73 55 544 www.palmako.com	Customer	Log 28x114
	Drawn by 350	
	Date 02.12.2021	File Melanie 7.0 m2.dwg
		Page 3

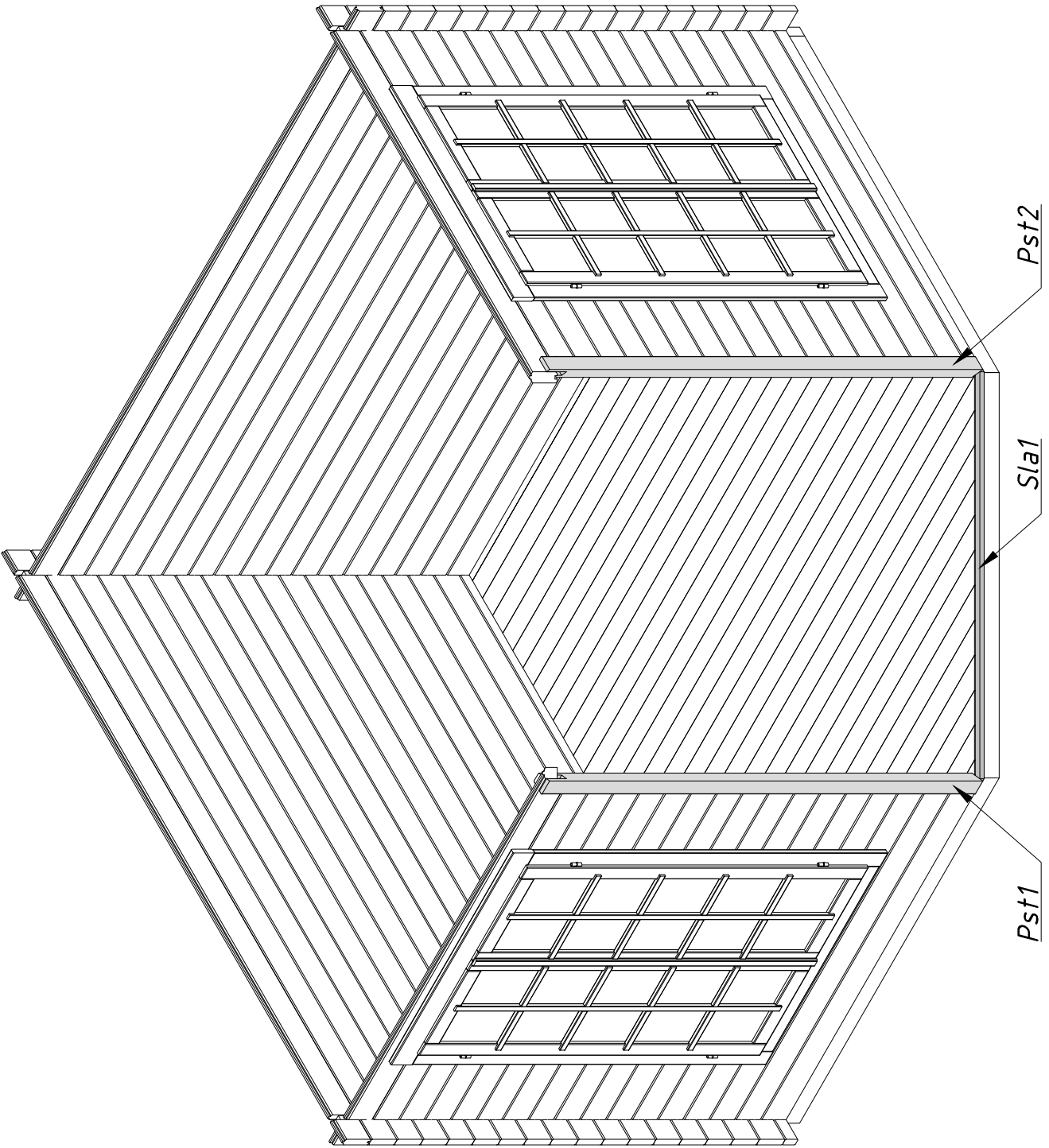

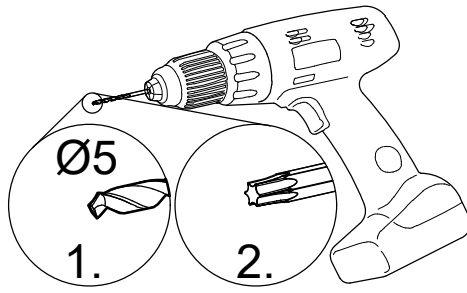
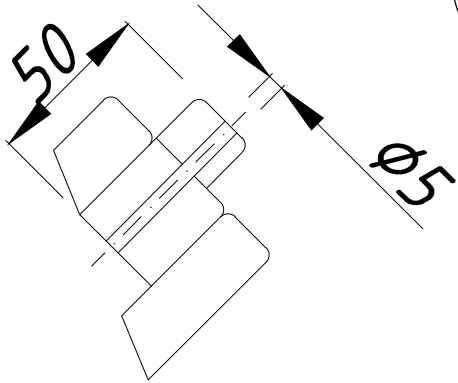

5x90
4 pcs

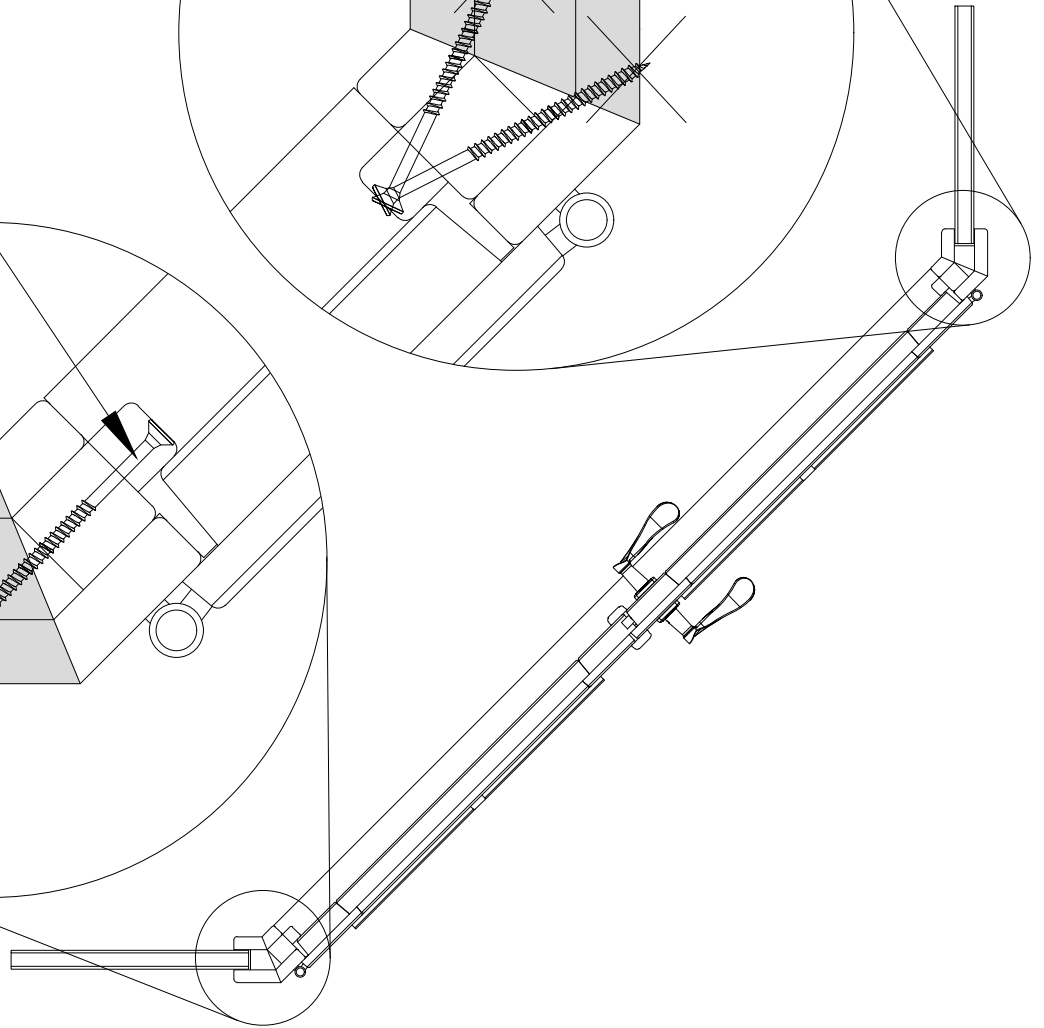
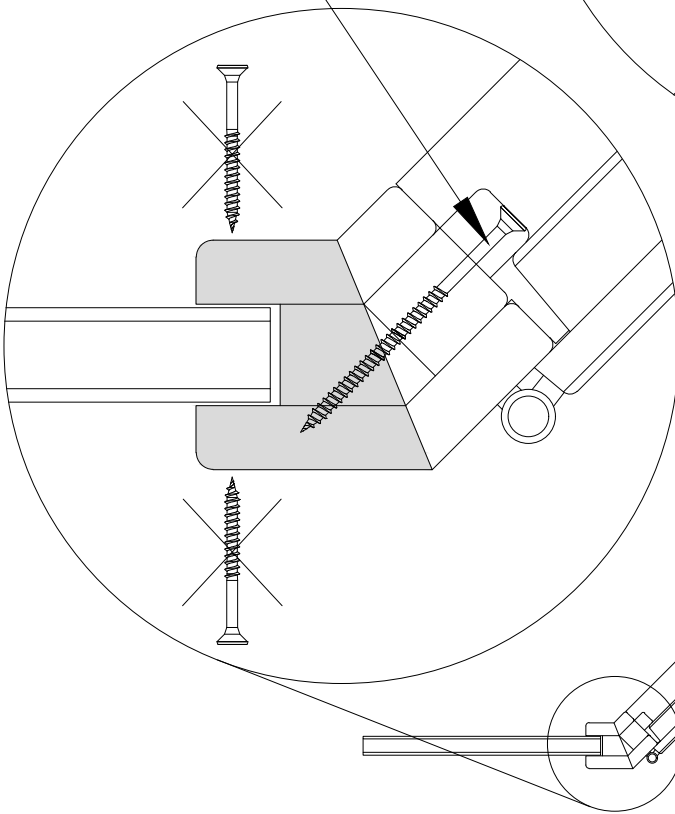
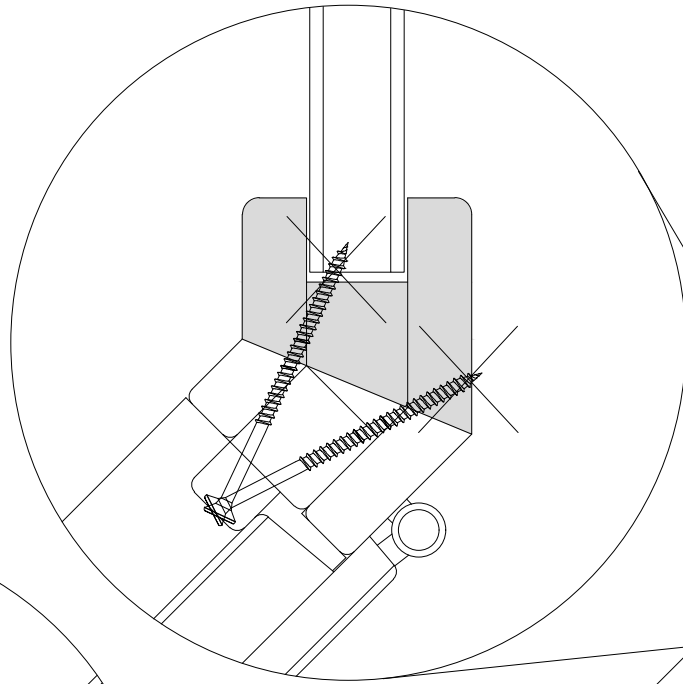

A:A

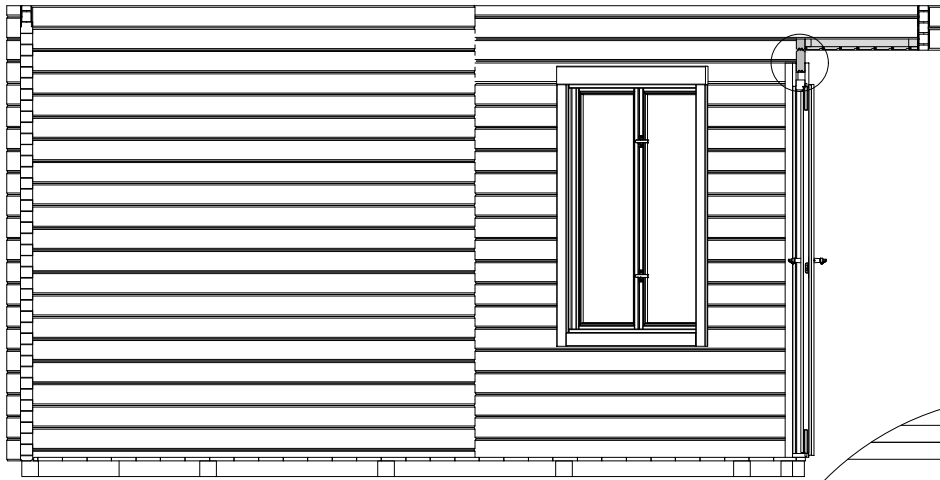

$\varnothing 3,5 \times 50 \times 3$

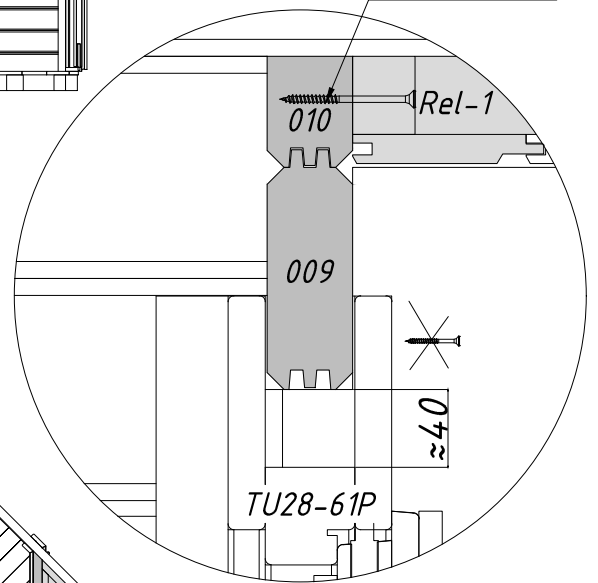

A

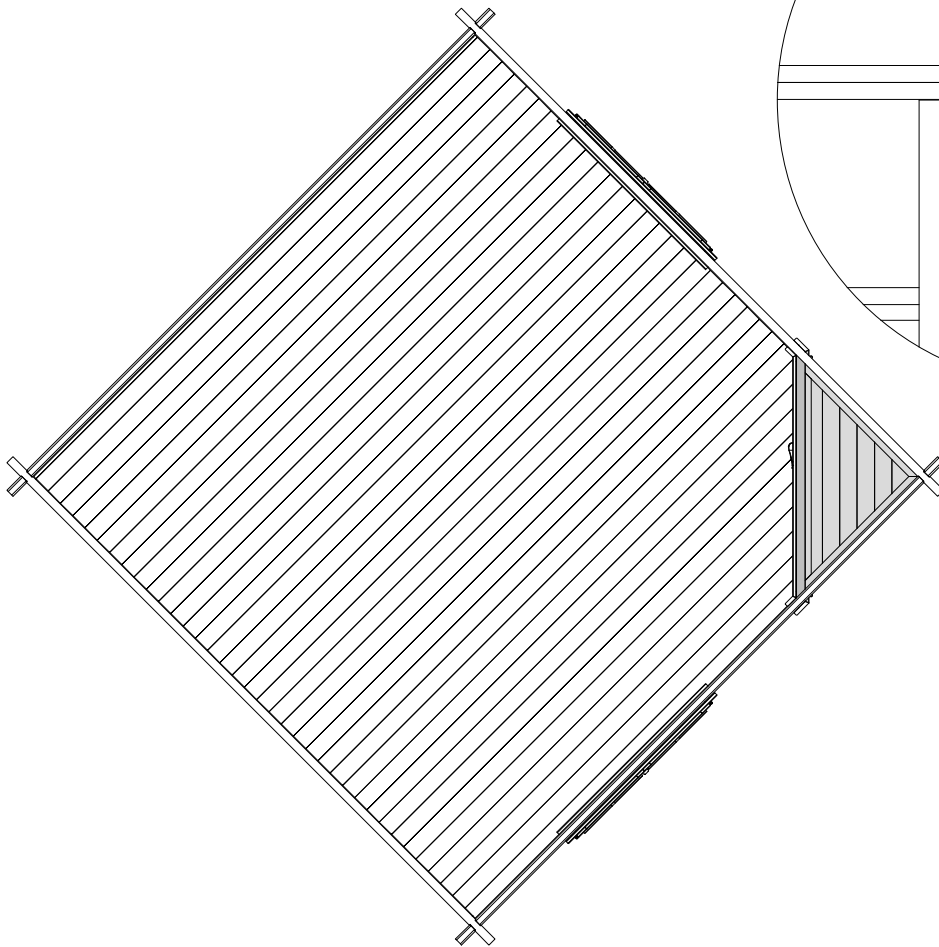

A

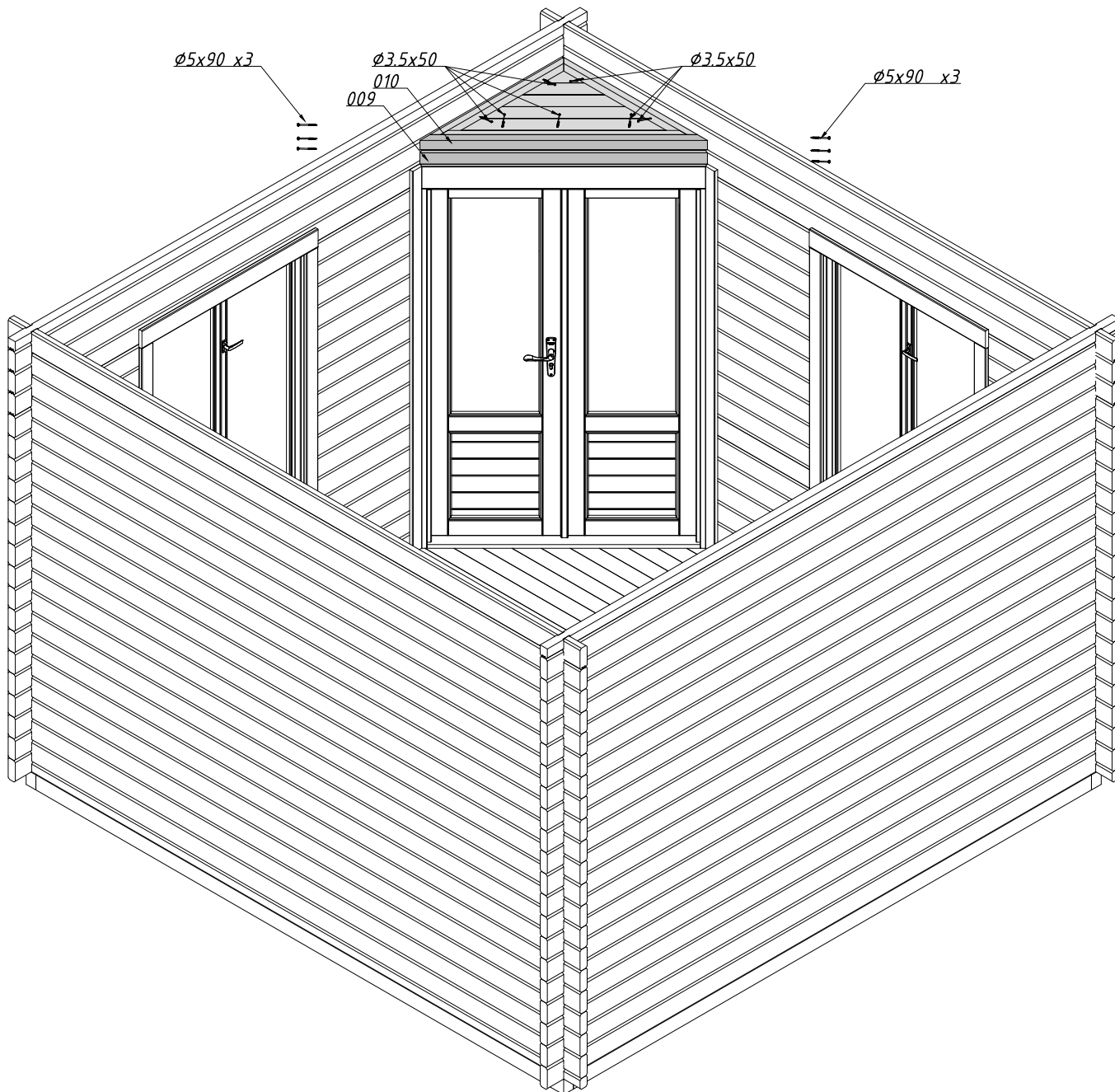

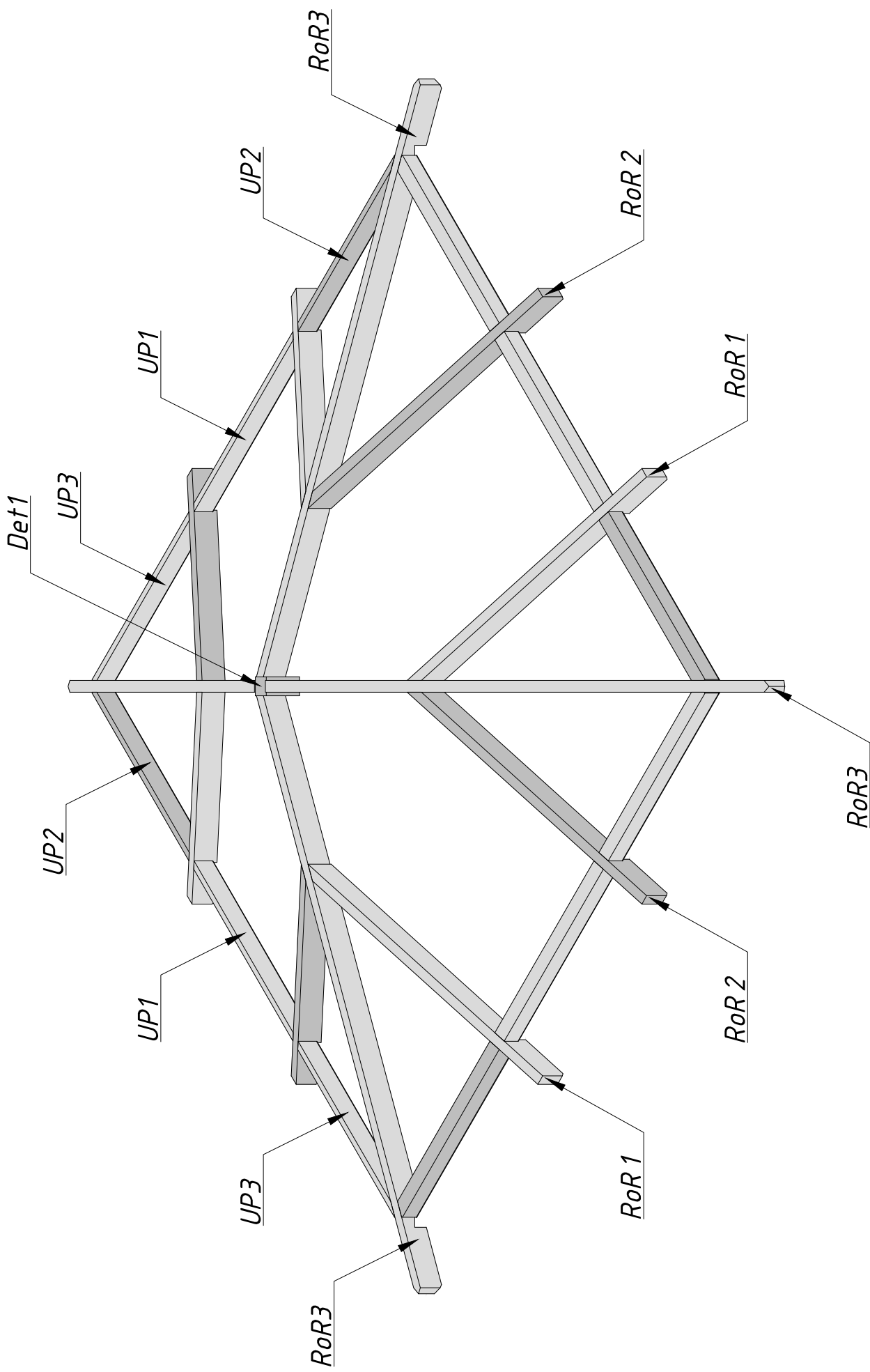

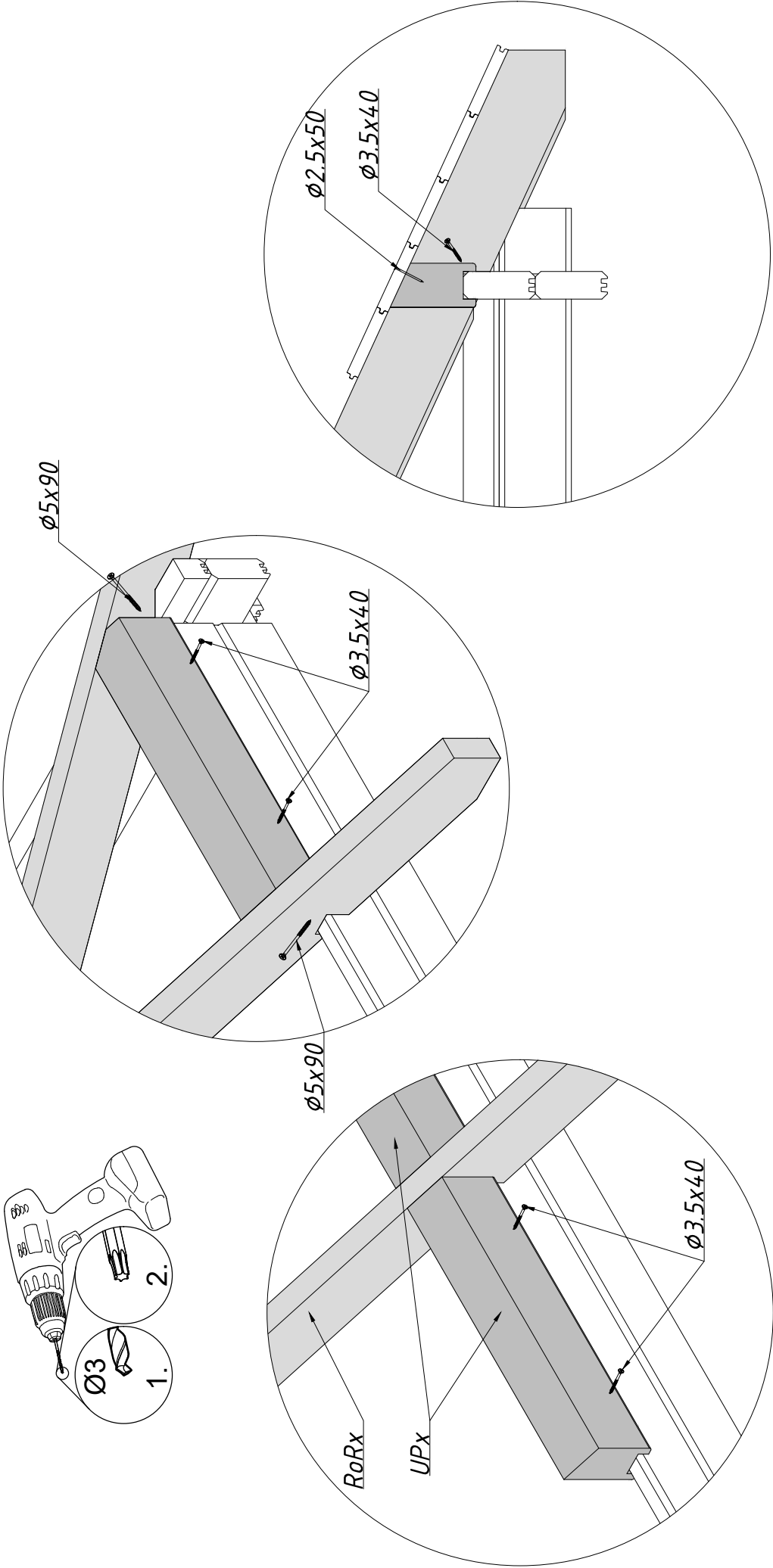

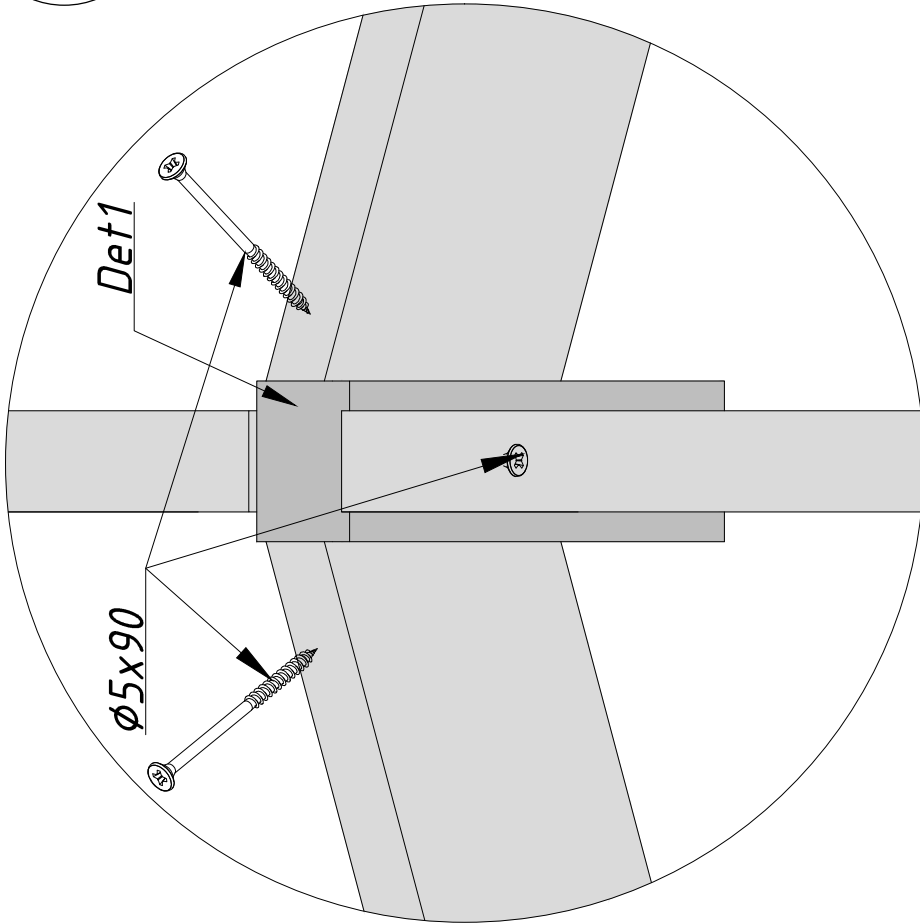
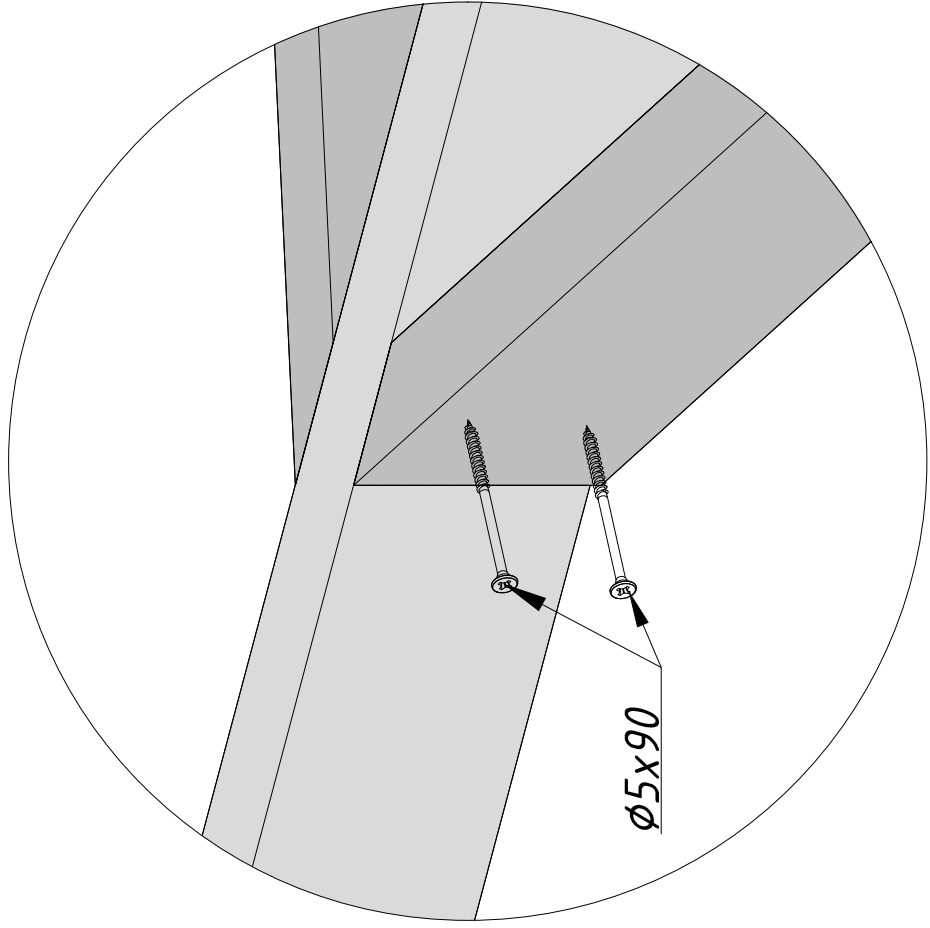
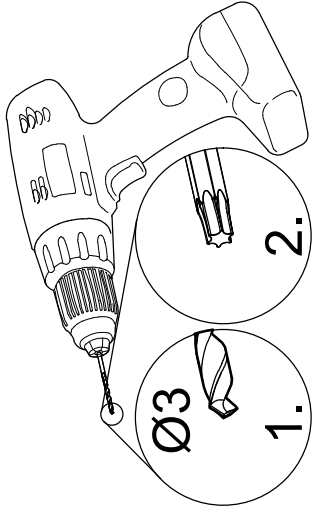

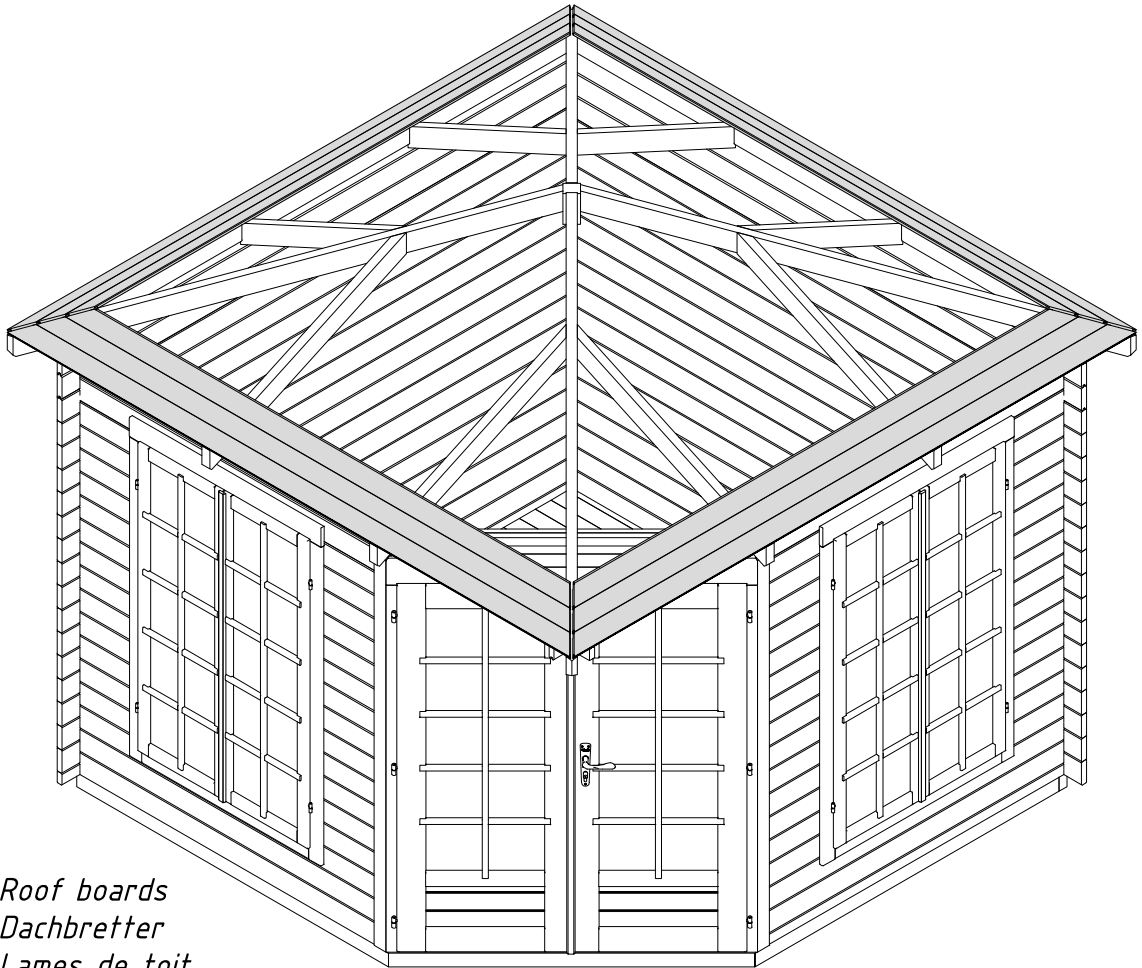

- EN *Roof boards*
- DE *Dachbretter*
- FR *Lames de toit*
- ES *Tablas de techo*
- IT *Tavole di tetto*
- NO *Takborden*
- SE *Takbrädor*
- FI *Kattolaudat*
- DK *Tagbrædder*
- NL *Dakbeschot*
- PT *Tábuas de telhado*
- CZ *Dřevěné desky na střechu*
- PL *Deski dachowe*
- LT *Stogo lentos*
- LV *Jumta dēļi*
- RU *Доски для крыши*
- ET *Katuselauad*

