

Techn. Data: Malaga B

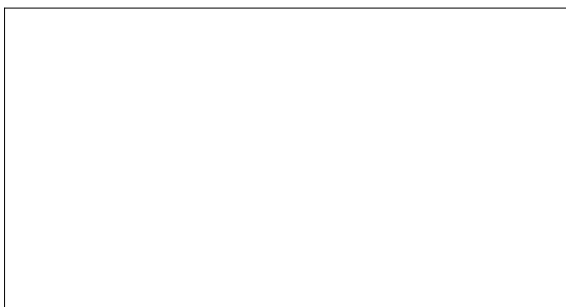

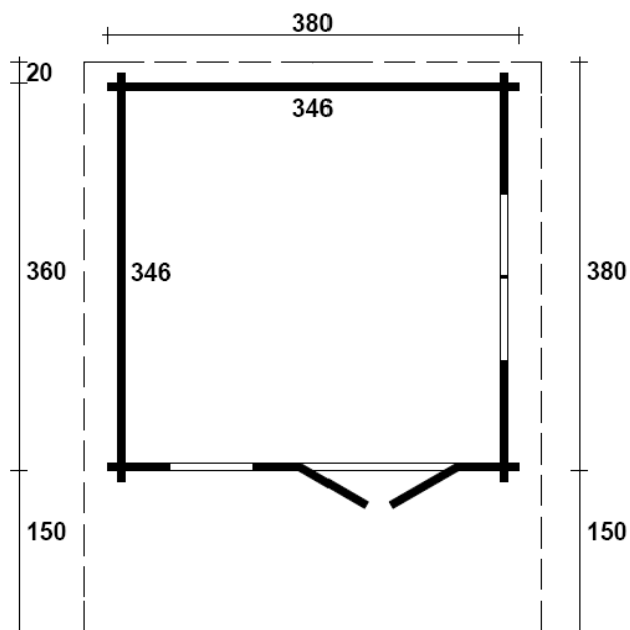







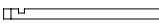



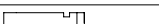
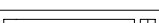
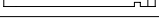

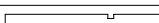

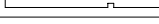
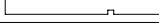
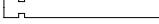





Log length (W x D): 380 x 380 cm

Wall size(outside): 360 x 360 cm · Log thickness: 70 mm

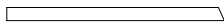

Note: All dimensions are approximate !

Specification - Malaga B 70

Nr	Description	Profile mm	Length mm	Quantity	
1	Foundation beams	70x60	3570	2	
1a			3430	7	
2			1785/575	1/1	
2a			3800	1	
3			3800	17	
4			3800	20	
5			575	26	
6			1785	8	
7			1130	15	
8				440	9
9				1410	1
10				1690	1
11				1970	1
12				4080	1
13				4360	1
14				4640	1
15				4920	2
16		 70x123		5300	2(1+1)
17	Purlin 	 70x120		5300	3(2+1)
18	Gable 	 114	3800	2	
19	Double door ca. 1425 x 1955 mm			1	
20	Double window ca. 1530 x 990 mm			1	
21	Window ca. 765 x 990 mm			1	
22	Roofing felt			Roll	
23	Roof board	Vers. 1 >  18x88	2195	--	
		Vers. 2 >  18x110	2195	96+2	
24	Floor board	 28x110	3456	32+1	
25	Facia board 	18 x 145	2233	4	
26	Facia board 	18 x 115	2233	4	
27	Eave edging	18 x 90	2233	4	
28	Roof edge reinforcement	18 x 115	5300	2	
29	Roof edge reinforcement	28 x 28	2650	4	
30	Diamond 			2	
31	Baseboard		ca. 13,8 m		
32	Storm rod		2080	4	
33	Screws 4,0 x 40, 4,5 x 70			1 Bag	
34	Nails 2,2 x 50, 2,5 x 70			1 Bag	
35	Roofing nails 2,8 x 15			1 Bag	
36	Nut, washer			8	
37	Hitblock				

Walls - Malaga B 70

Wall A

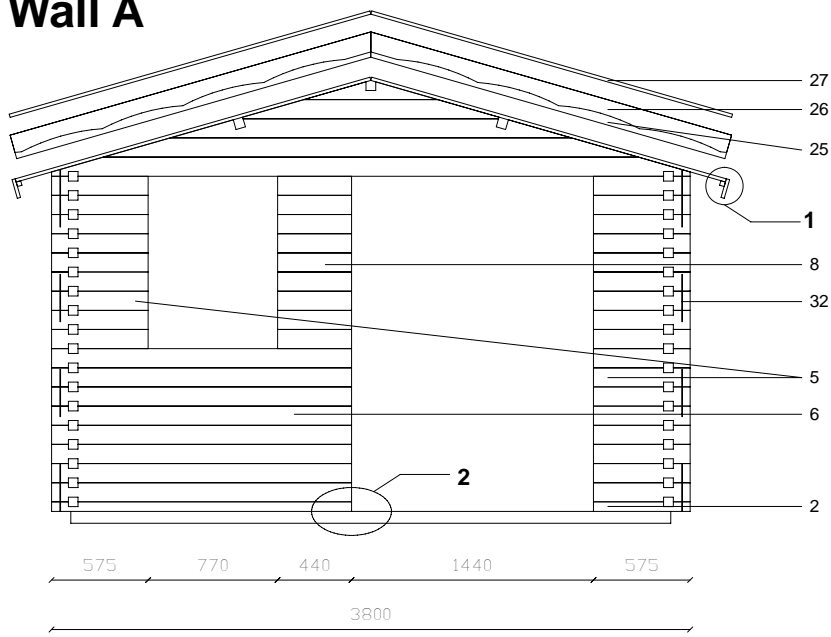

1

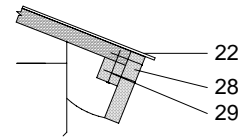

2

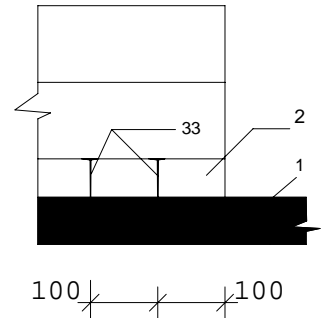

Wall B

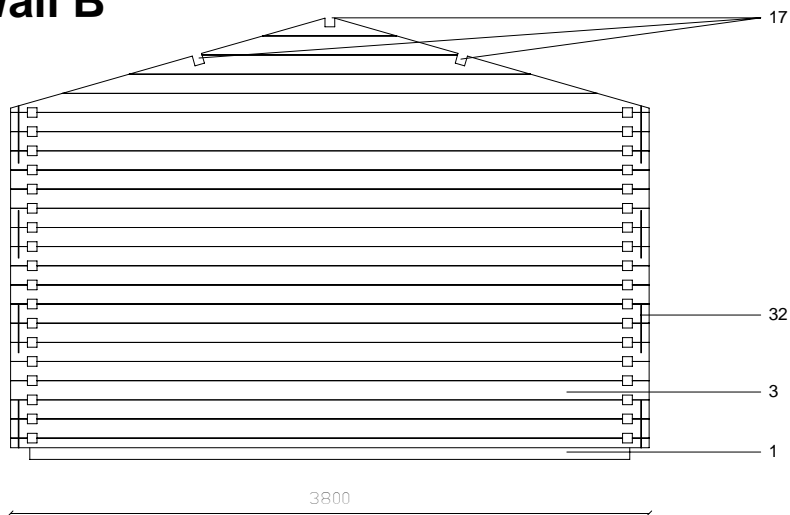

A-A

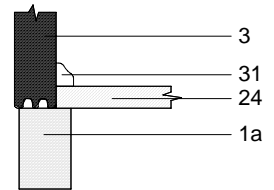

B-B

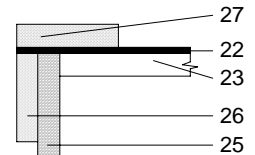

Wall C

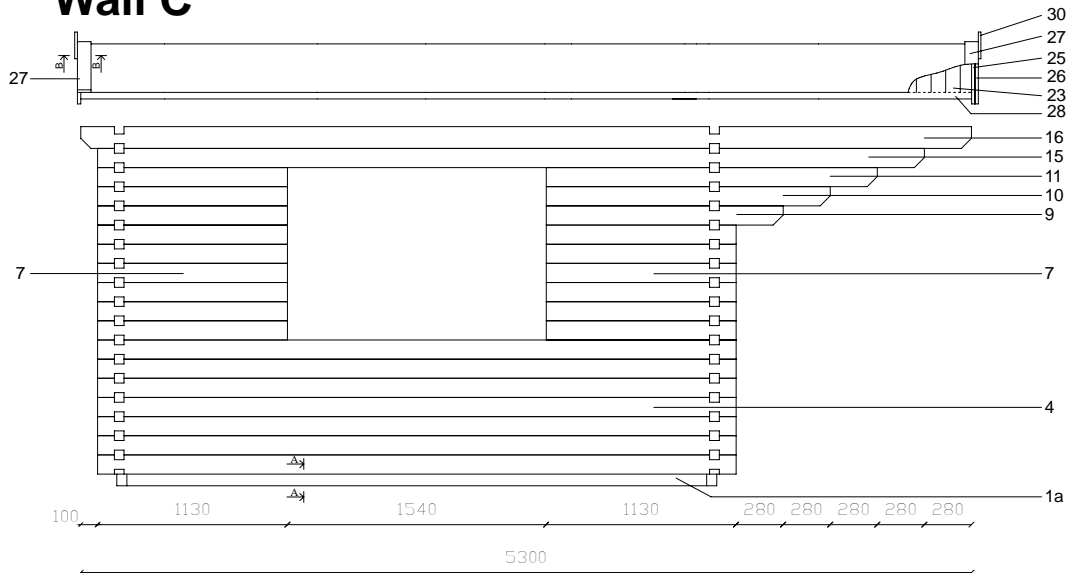

Foundation- and ground plan Malaga B 70

Wall D

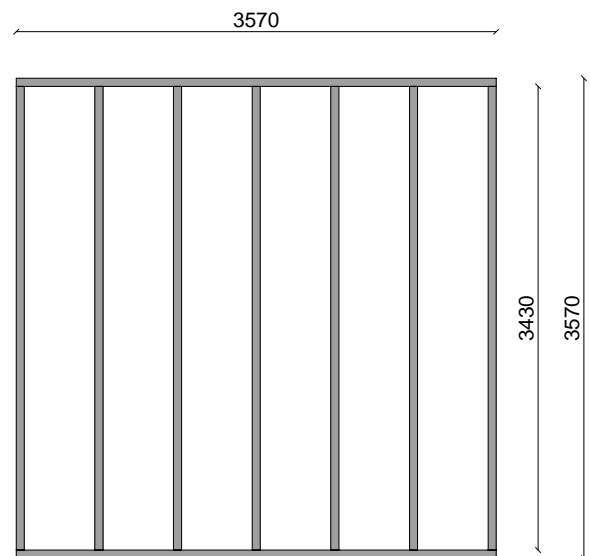
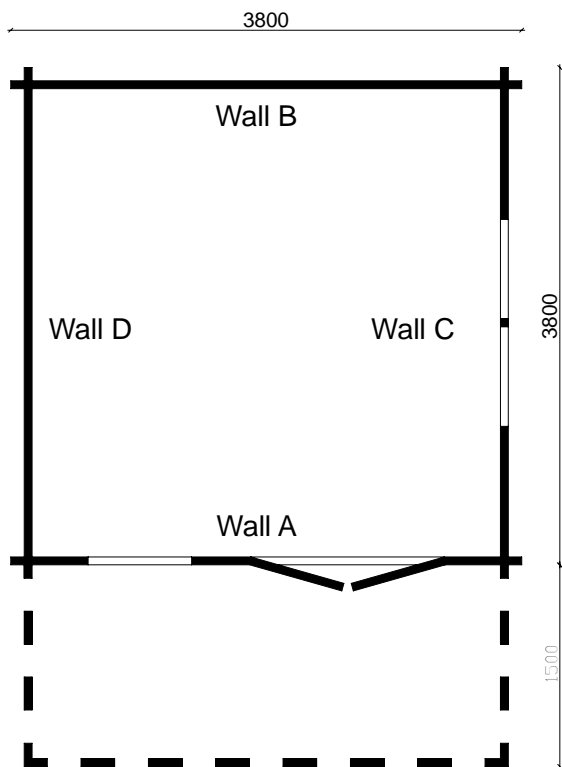
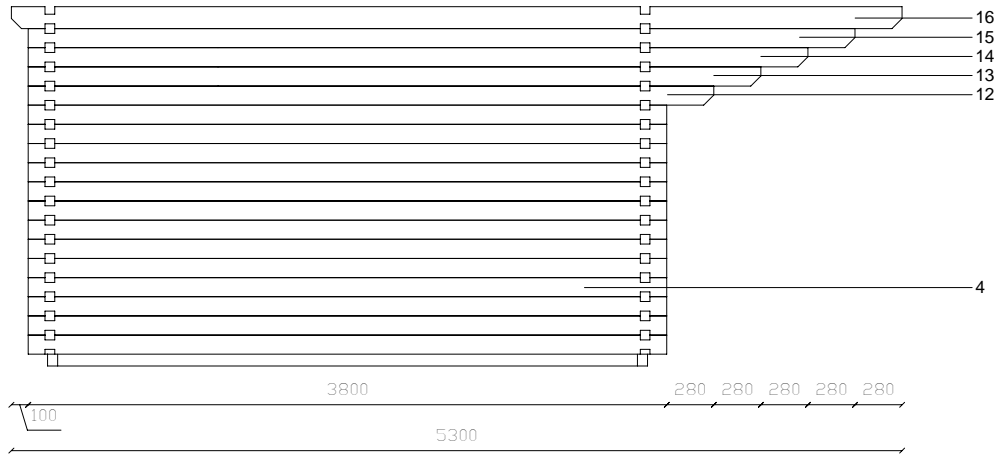

Foundation - Malaga B 70

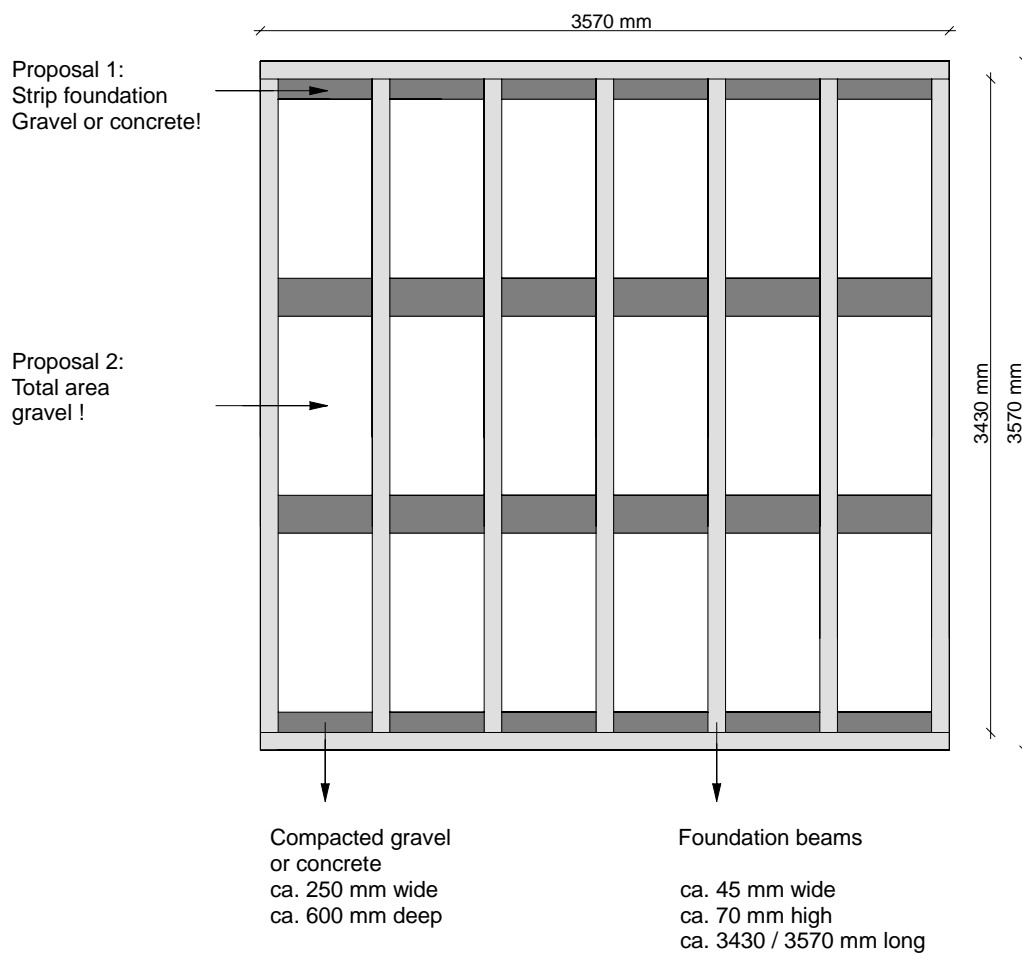

House	Number of foundation beams
Malaga B 70	2(ca. 60x70x3570 mm)
	7(ca. 60x70x3430 mm)