

Installation manual

Montageanleitung • Notice de montage • Istruzioni per il montaggio
Manual de montaje • Monteringsanvisning • Installatiegids • Asennusohje • Installationsmanual

Element house EL18-3345

Elementhaus • Maison à modules • Casetta in elementi • Cobertizo • Redskapsbod • Element huis • Elementti
piharakennus • Friggebod

Width 330 x Depth 452 cm



Breite/Tiefe • Largeur/Profondeur • Lunghezza/Profondità • Ancho/Profundidad • Bredde/Dybde • Breedte/Diepte •
Leveys/Pituus • Bredd/Längd







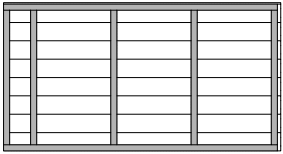
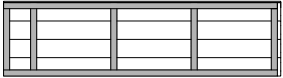

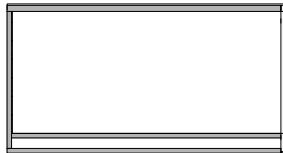
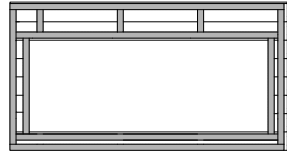
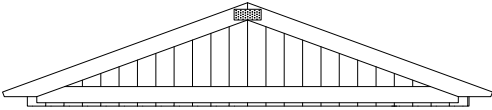
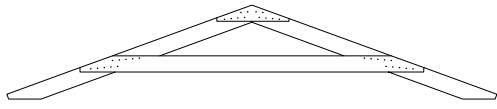
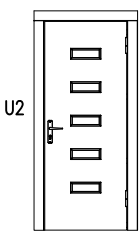
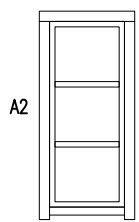





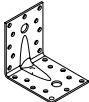

Log thickness 18 mm

Bohlenstärke • Épaisseur des murs • Spessore delle pareti • Grosor de pared • Tykkelse • Wanddike •
Seinän paksuus • Väggtjocklek

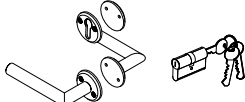
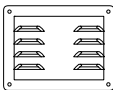

The producer shall have the right to make technical changes to the product • Technische Änderungen vorbehalten • Le
producteur réserve le droit d'effectuer des modifications techniques au produit • Il produttore mantiene il diritto di apportare
modifiche tecniche al prodotto • Reservado el derecho a modificaciones técnicas • Produsent forbeholder seg retten til å endre
tekniske egenskaper ved produktet • Alle rechten en technische wijzigingen voorbehouden • Valmistaja pidättää oikeuden tehdä
tuotteeseen teknisiä muutoksia • Tillverkaren har rätt att utföra tekniska förändringar för produkten

EL1		2055 x 1097 x 88	10
EL2		2055 x 553 x 88	1
EL3		2055 x 281 x 88	2
EL4		2055 x 1097 x 88	1
EL5		2055 x 1097 x 88	2
EL6		3629 x 765 x 63	2
EL7		3629 x 696 x 72	7
U105-15-920R	 <p data-bbox="491 1666 799 1816"> U1 U2 U1 - 19x40x980 2 pcs U2 - 19x70x1980 4 pcs </p>	870 x 1985 x 105	1
A105-3R	 <p data-bbox="491 1939 799 2107"> A1 A2 A1 - 19x70x830 2 pcs A2 - 19x70x1820 4 pcs A3 - 19x70x630 2 pcs </p>	660 x 1740 x 105	2

1	 Impregnated	45 x 145 x 4488	2
2	 Impregnated	45 x 145 x 3171	9
3		19 x 89 x 4488	37
4		44 x 95 x 4524	2
5		19 x 89 x 4990	48
6		16 x 120 x 1990	8
7		32 x 40 x 1930	4
8		16 x 95 x 4990	2
9		18 x 136 x 2055	4
F1		90 x 90 x 65	14
F2		Ø 6 x 120	36
F3		Ø 4.5 x 70	170
F4		Ø 4 x 50	230
F5		Ø 4 x 40	180
F6		Ø 3 x 70	800
F7		QULlink/ASSA QULSydamik/ASSA QULSydamikkate/ASSA	1 set
F8		QVentRest100x150Zn	2
F9		Ø 2.5 x 16	8

Ly_13.6 m2

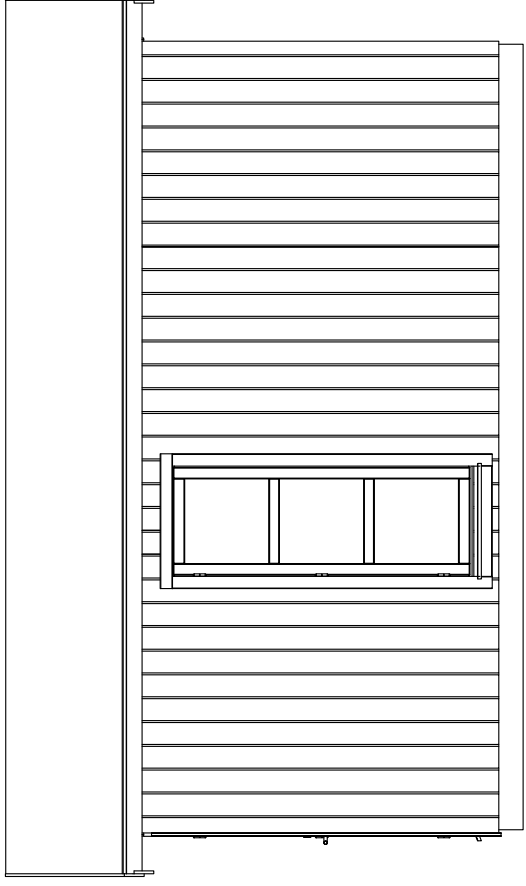

4524

Left

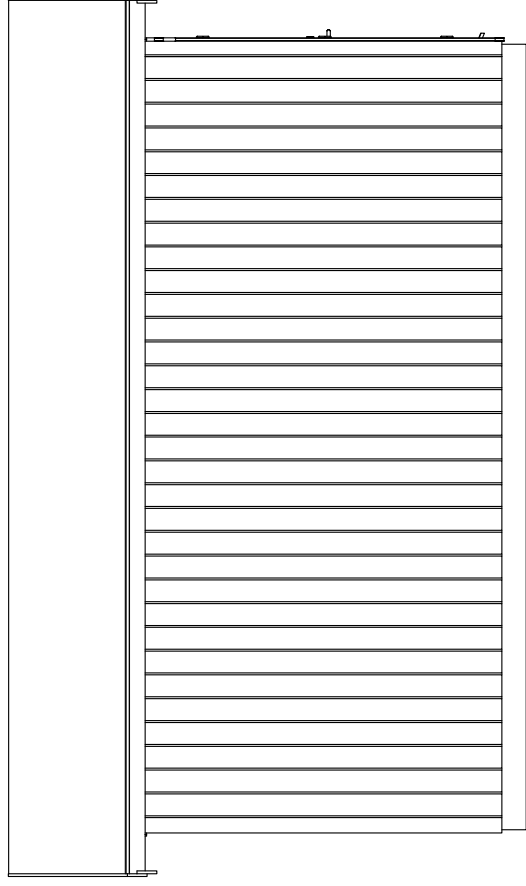

5022

Right



2957

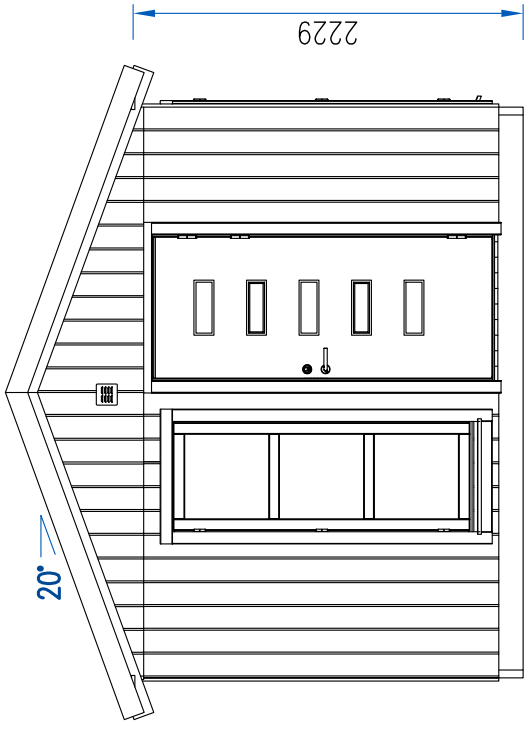

20°

2030

2229

3297

Front

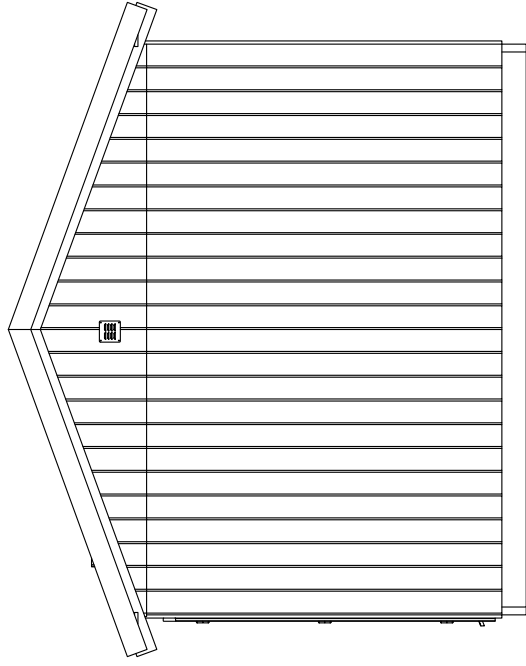

3665

Back

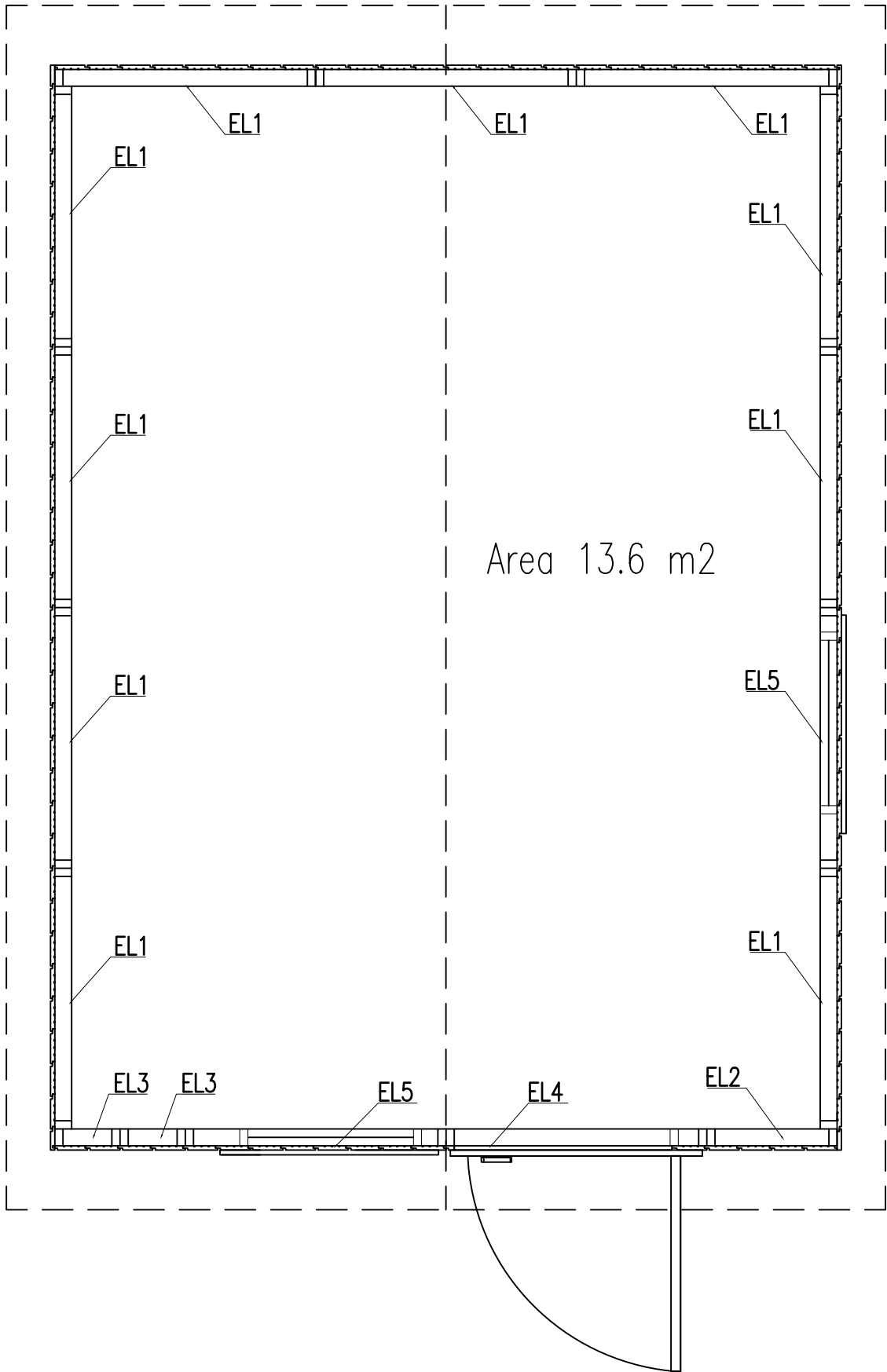

3261

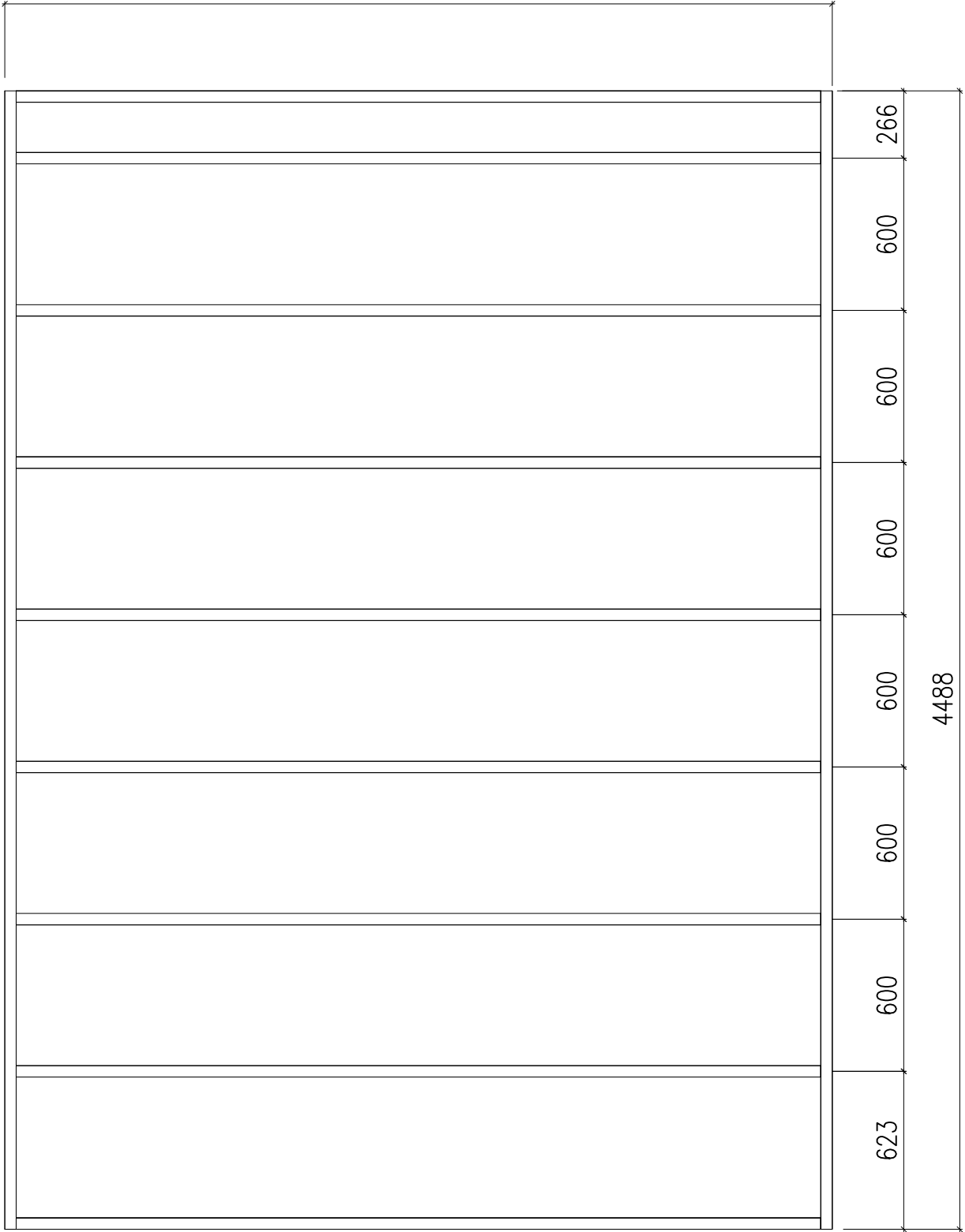

266

600

600

600

600

600

600

623

4488

Ly 13.6 m²
Rafter plan

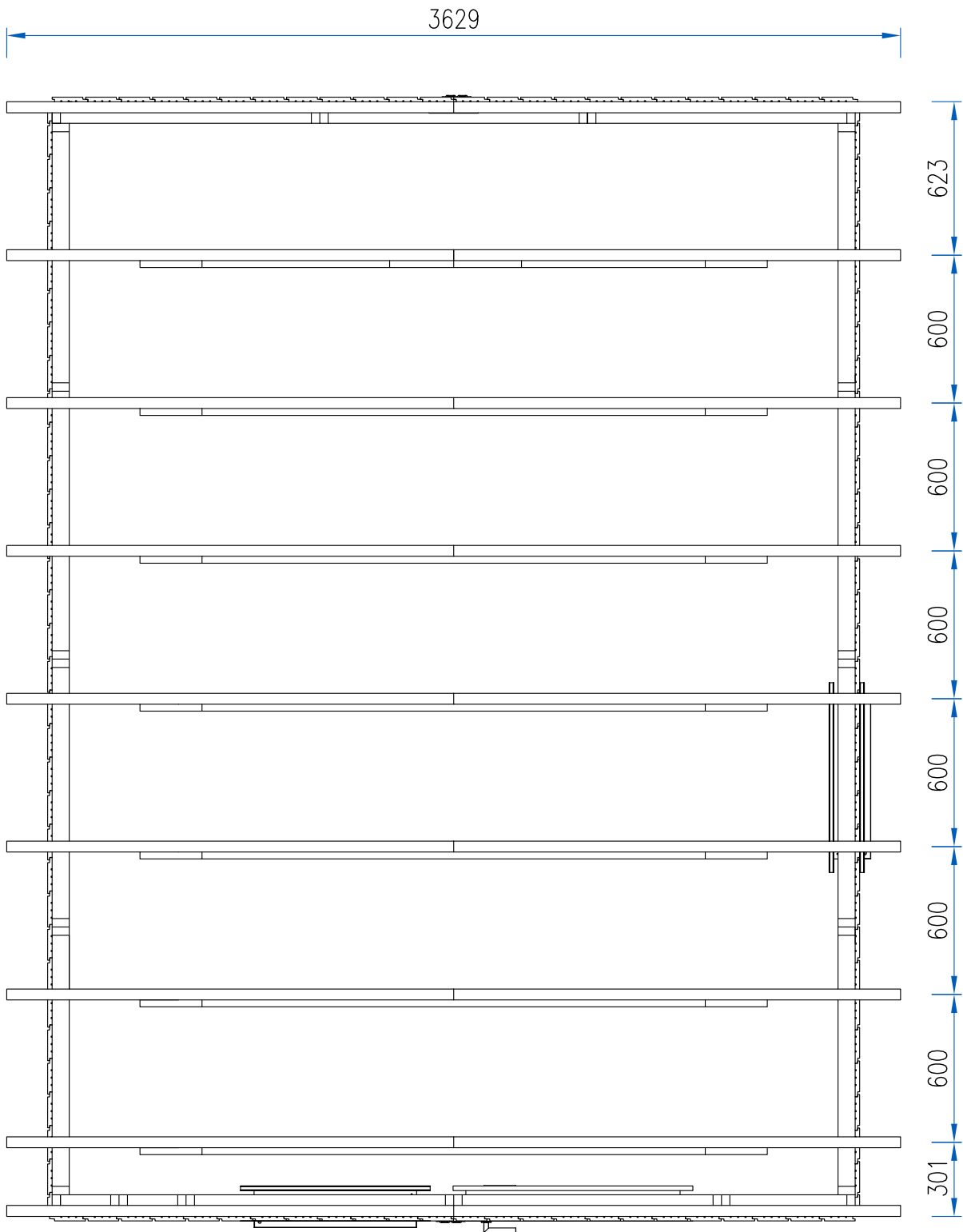

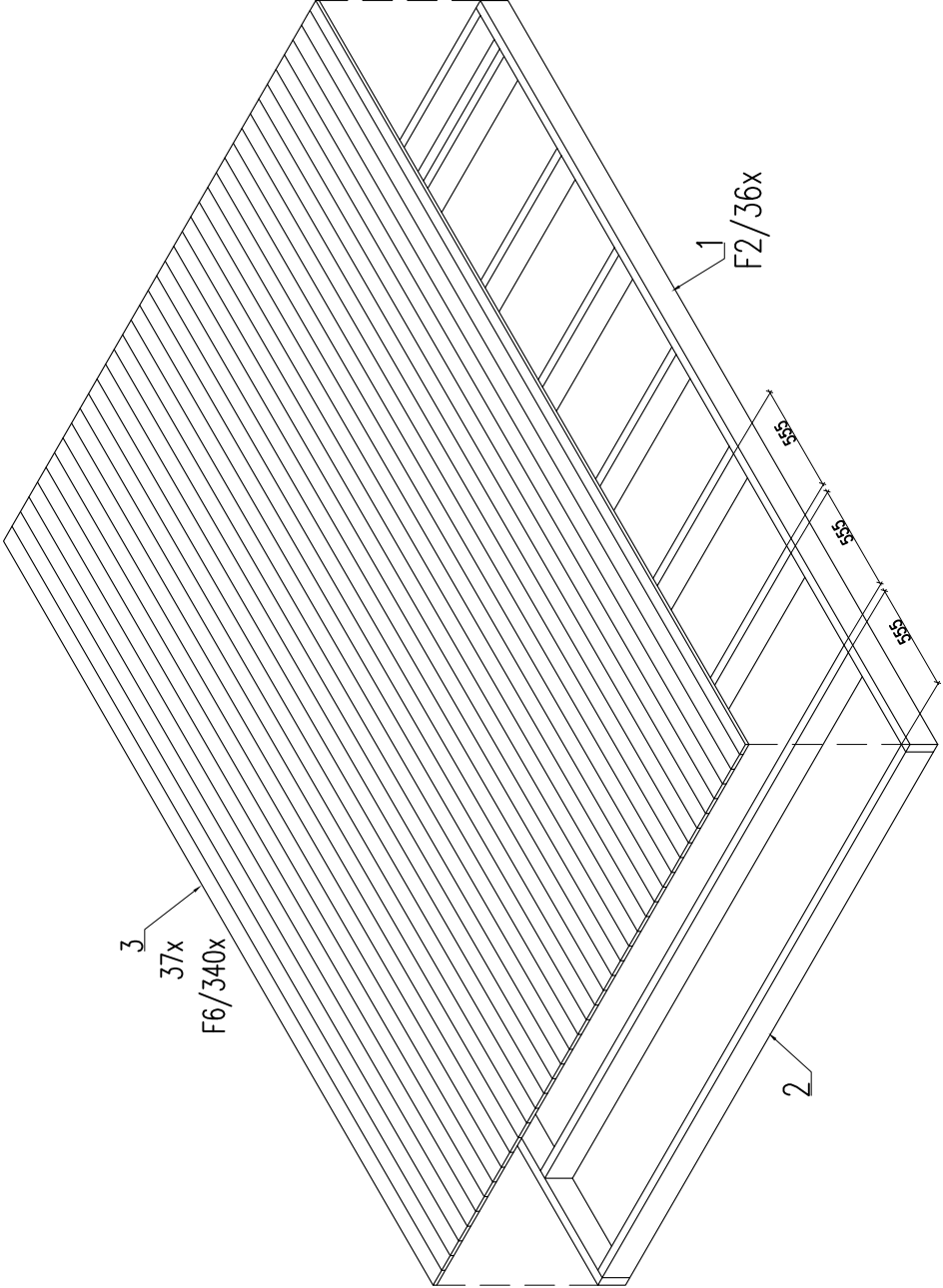

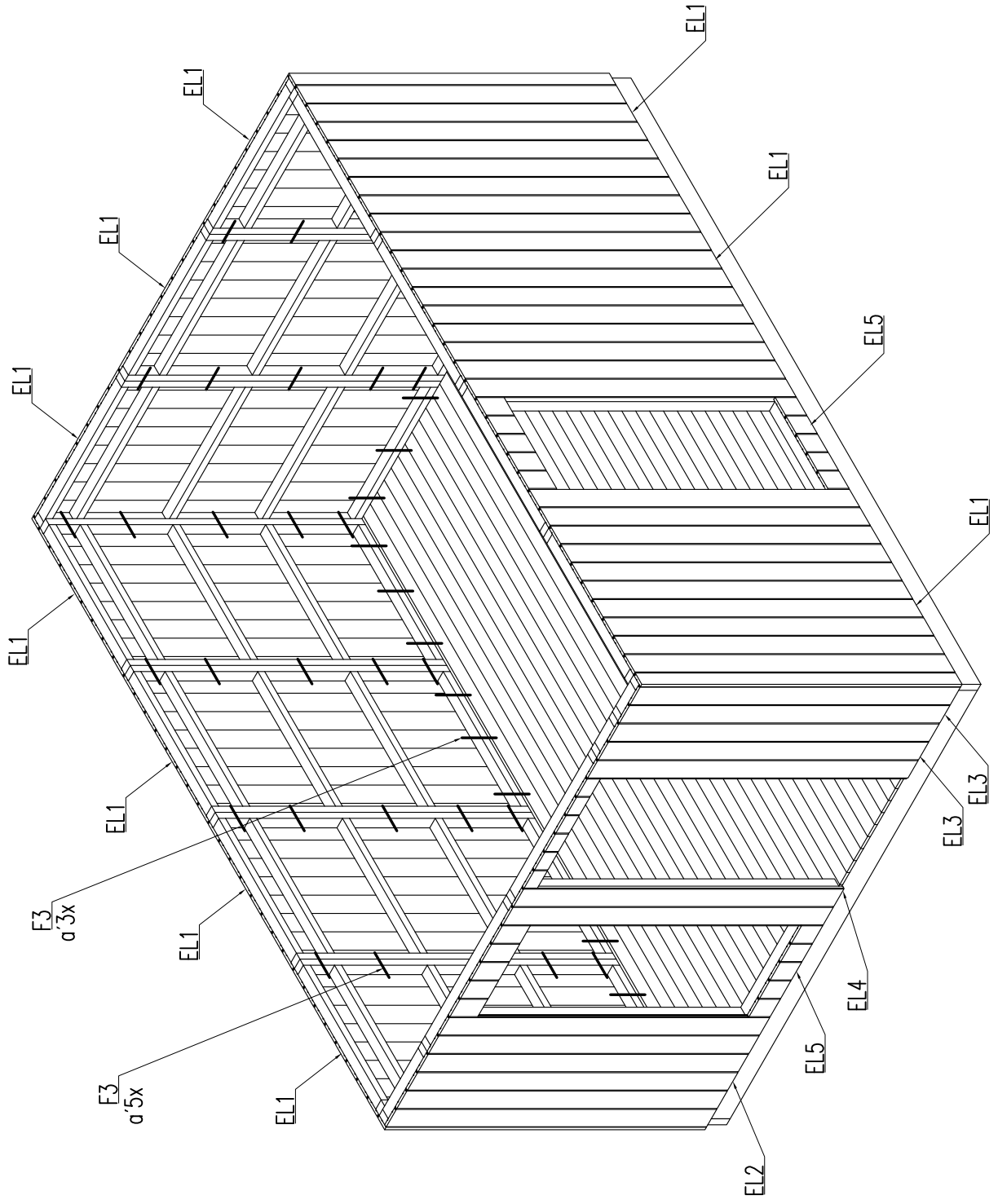

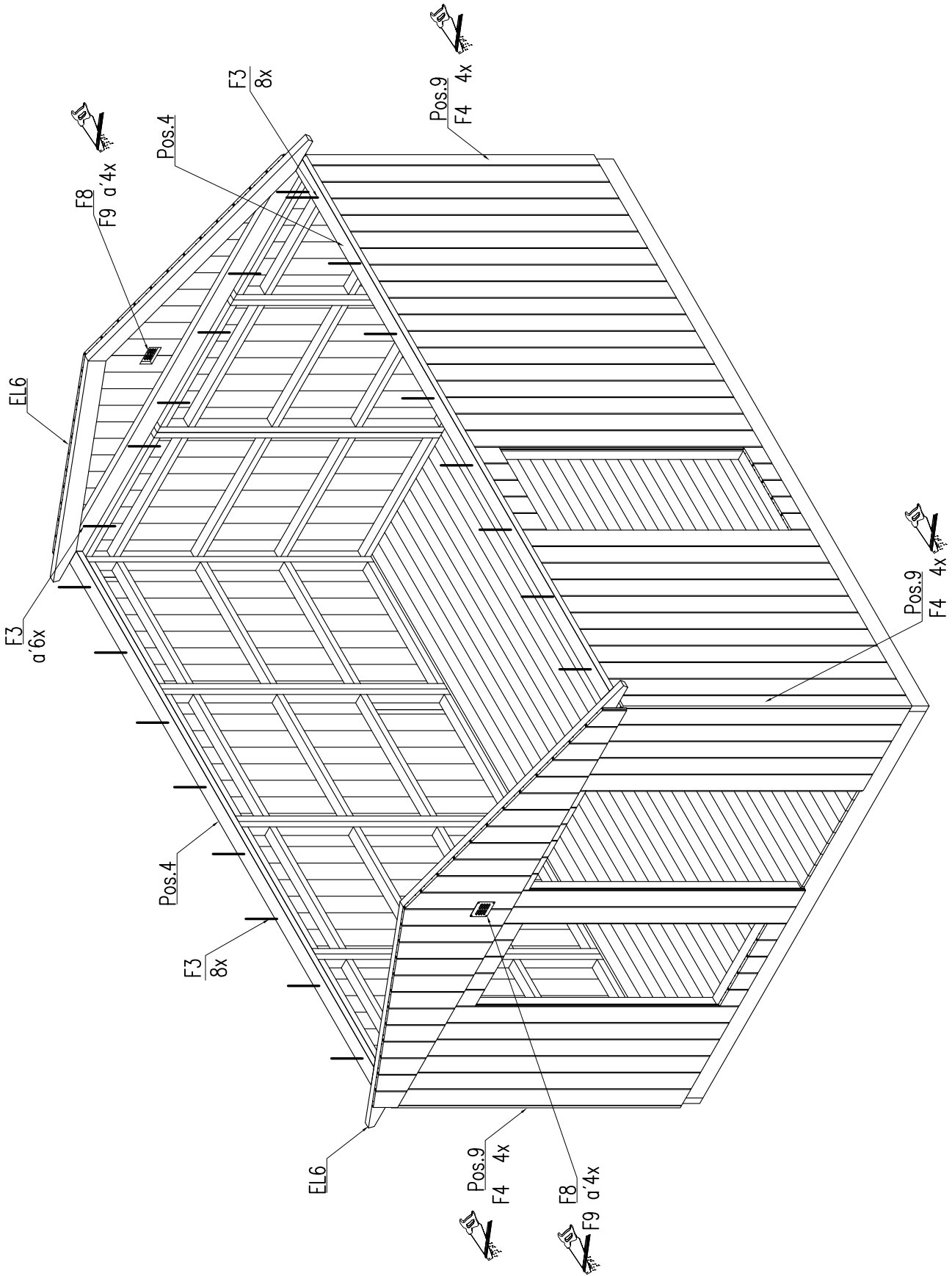

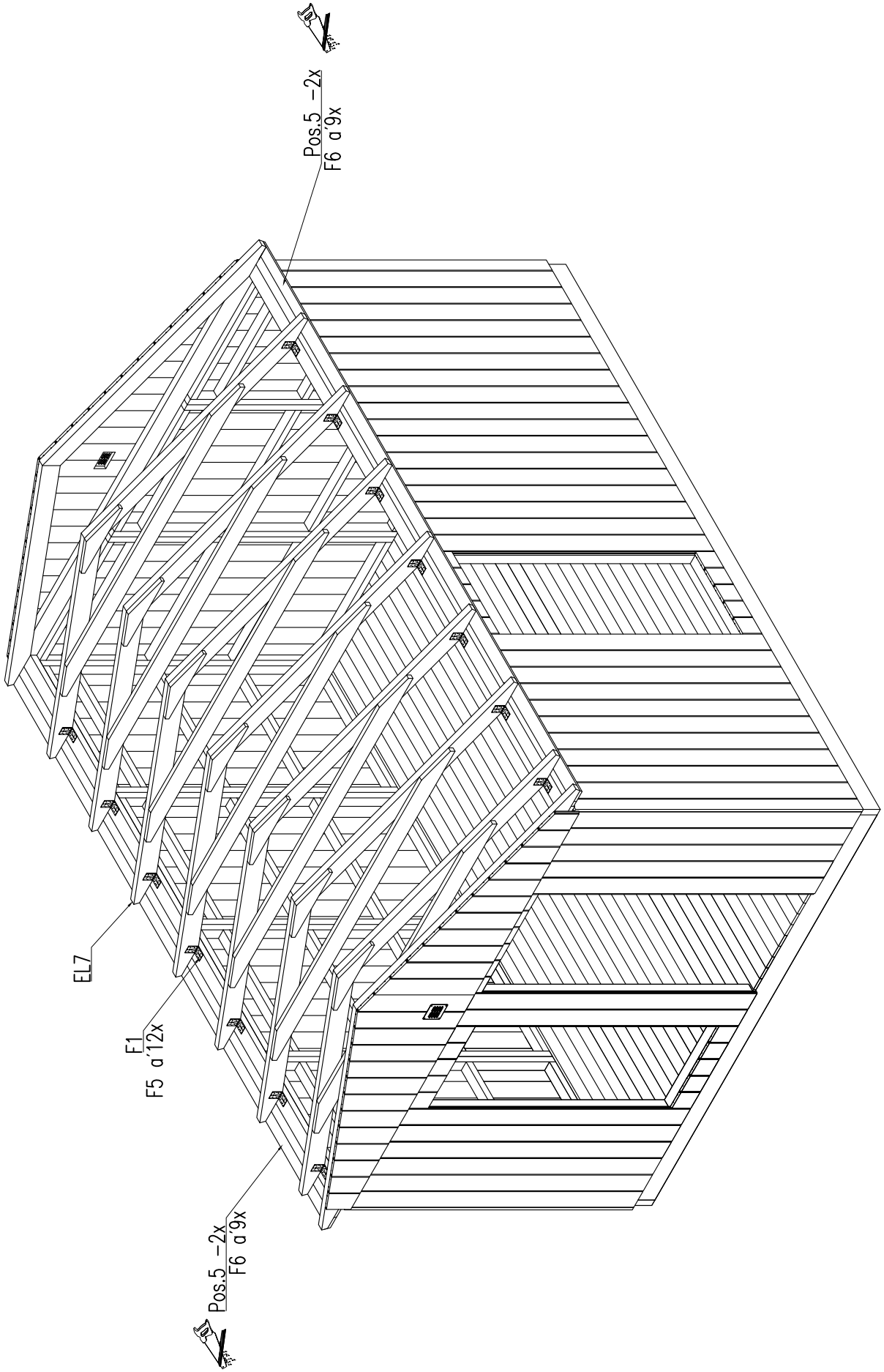

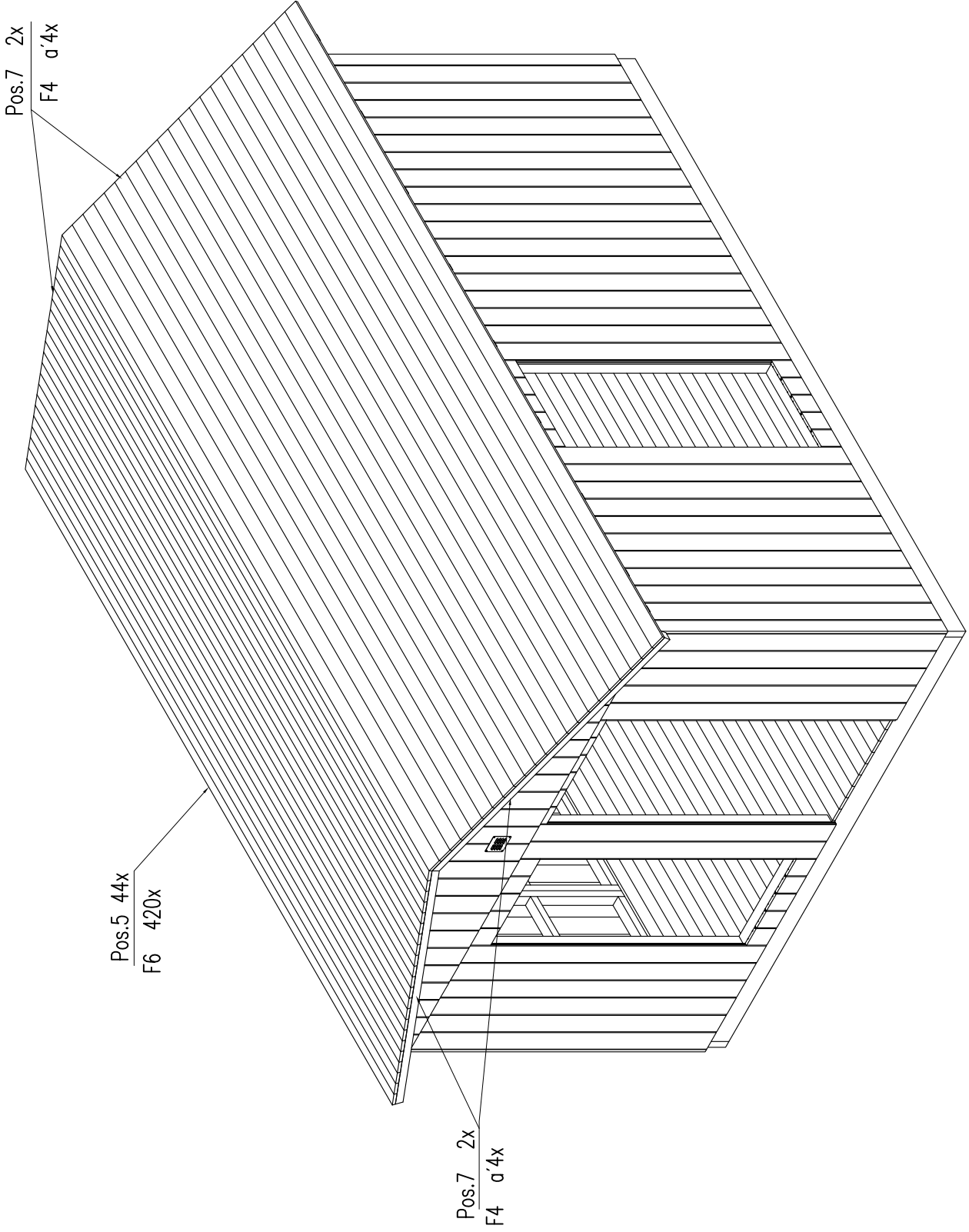

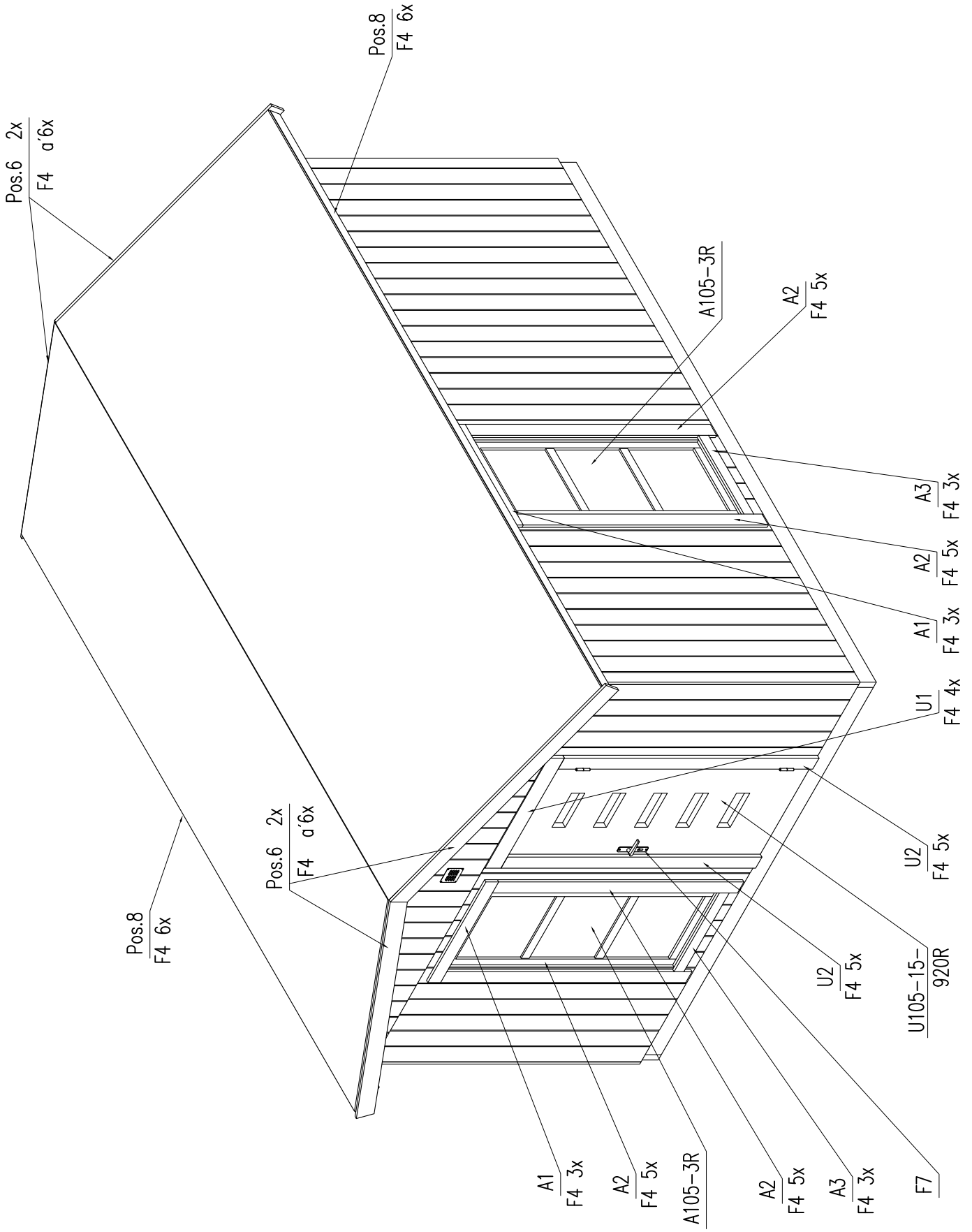

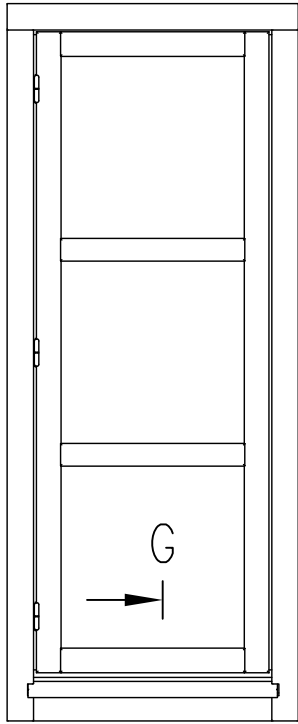

G-G (1:5)

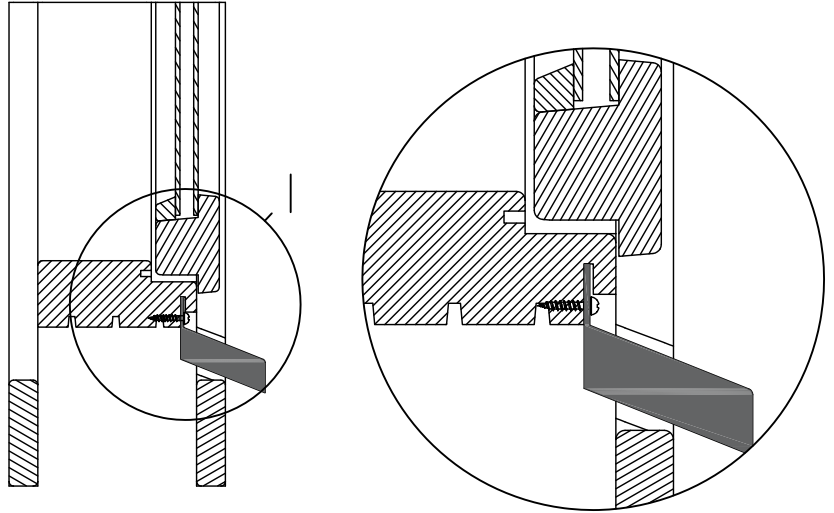

G

H (1:2.5)

