

*Lugano 44*  
*Art. Nr. 4420599.2*

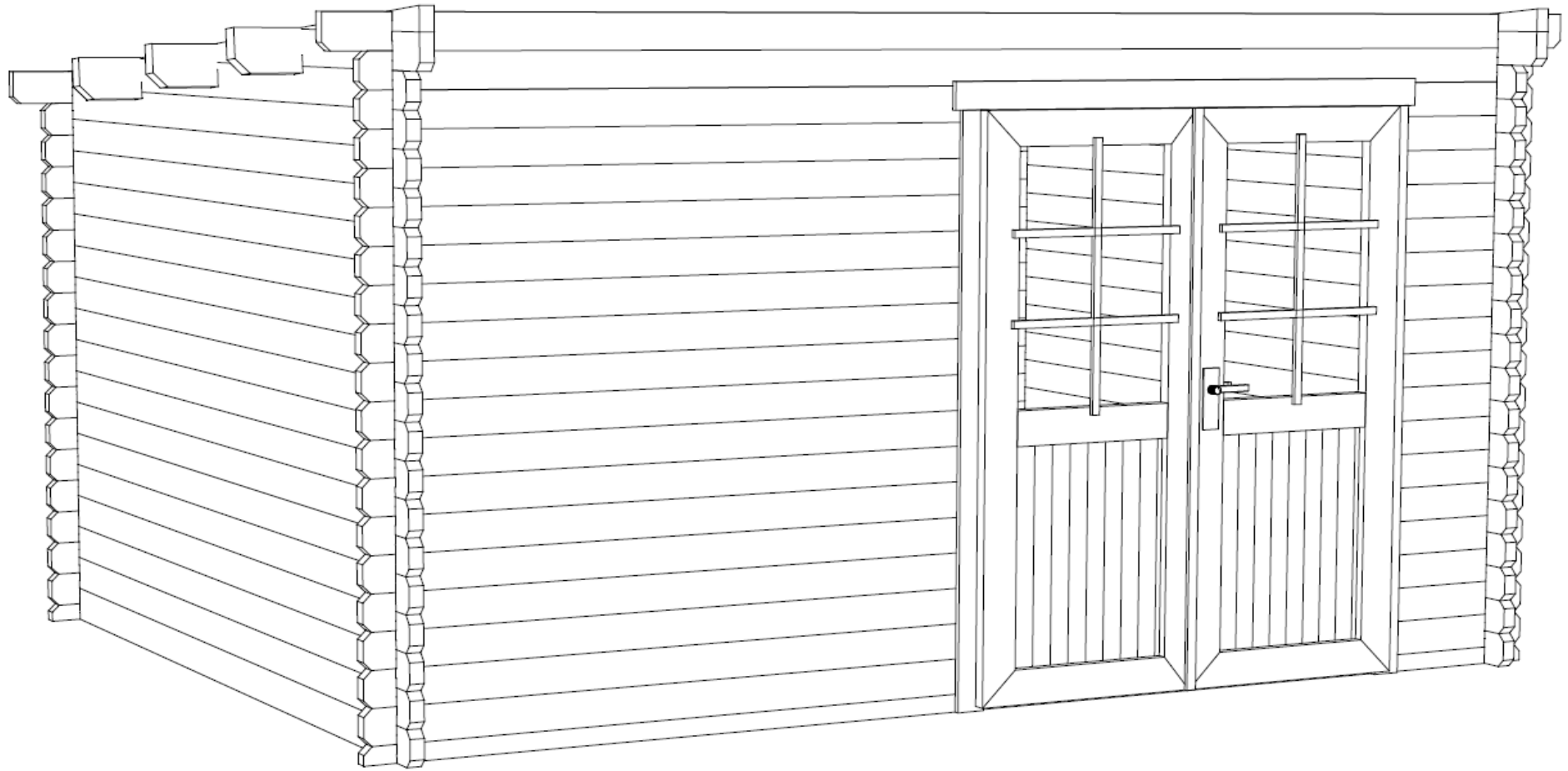

Art.Nr. 4420599.2

GROUNDPLAN - GRUNDPLAN - PLAN DE MASSE

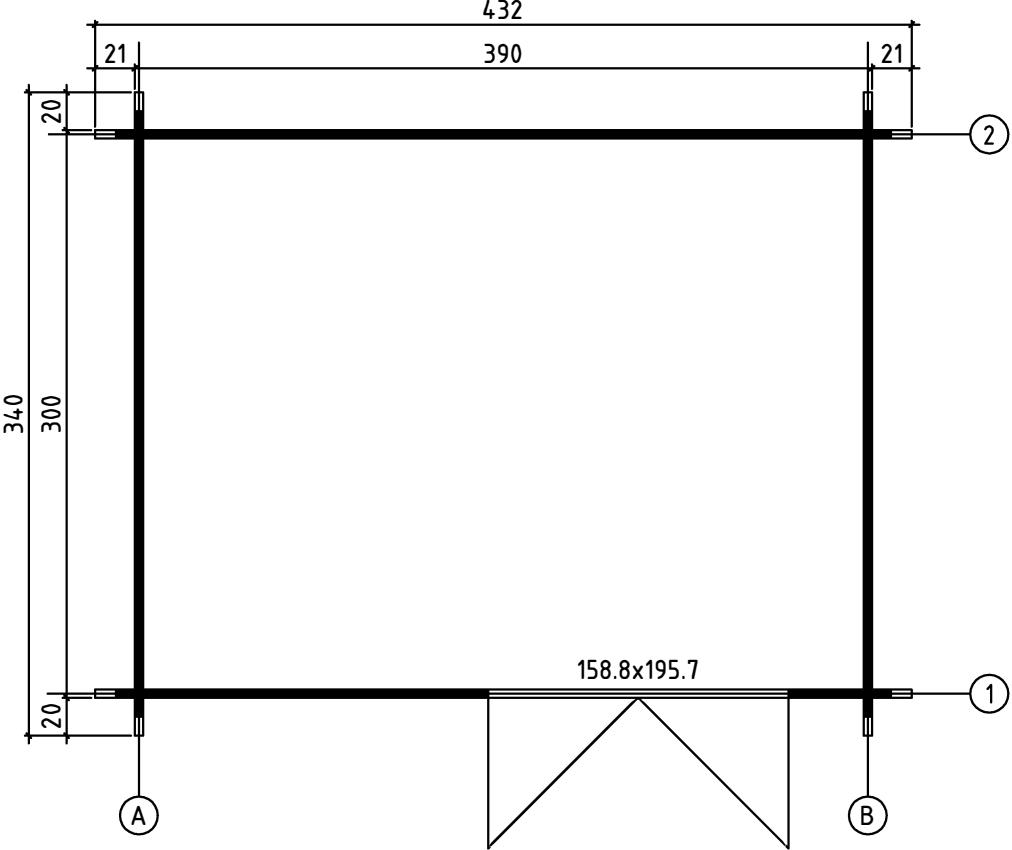

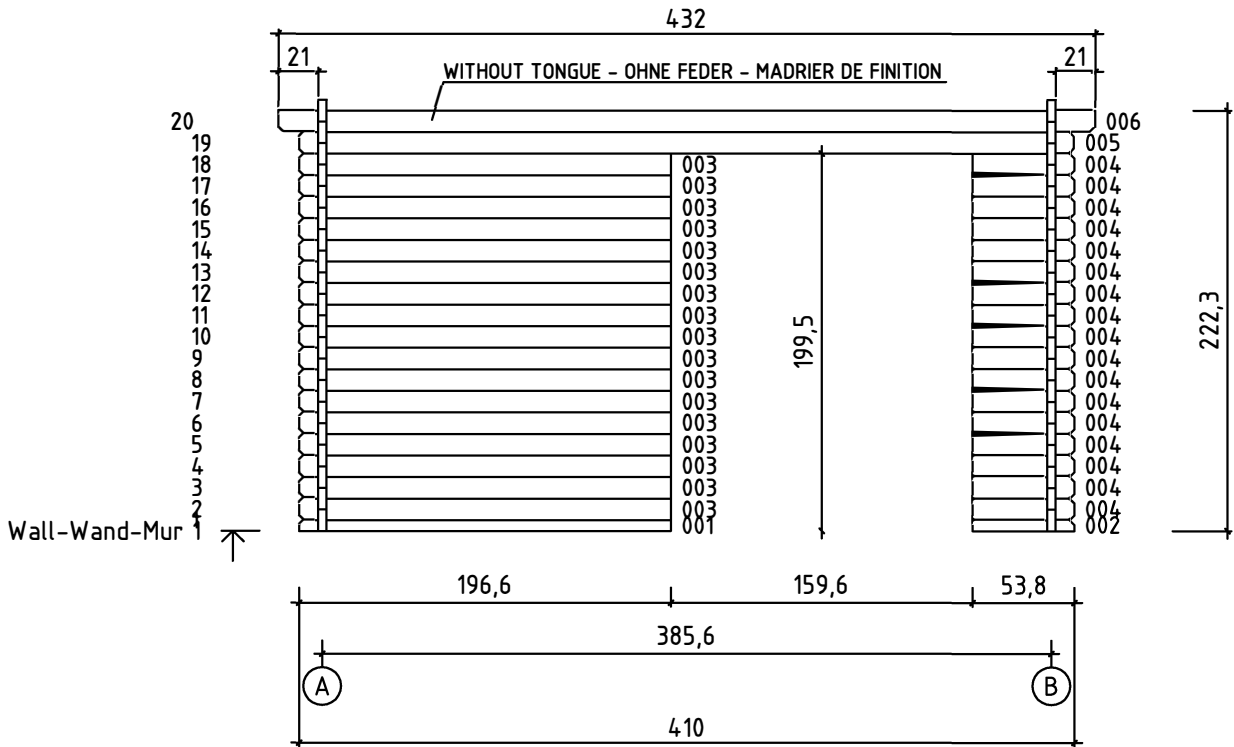

Wall-Wand-Mur



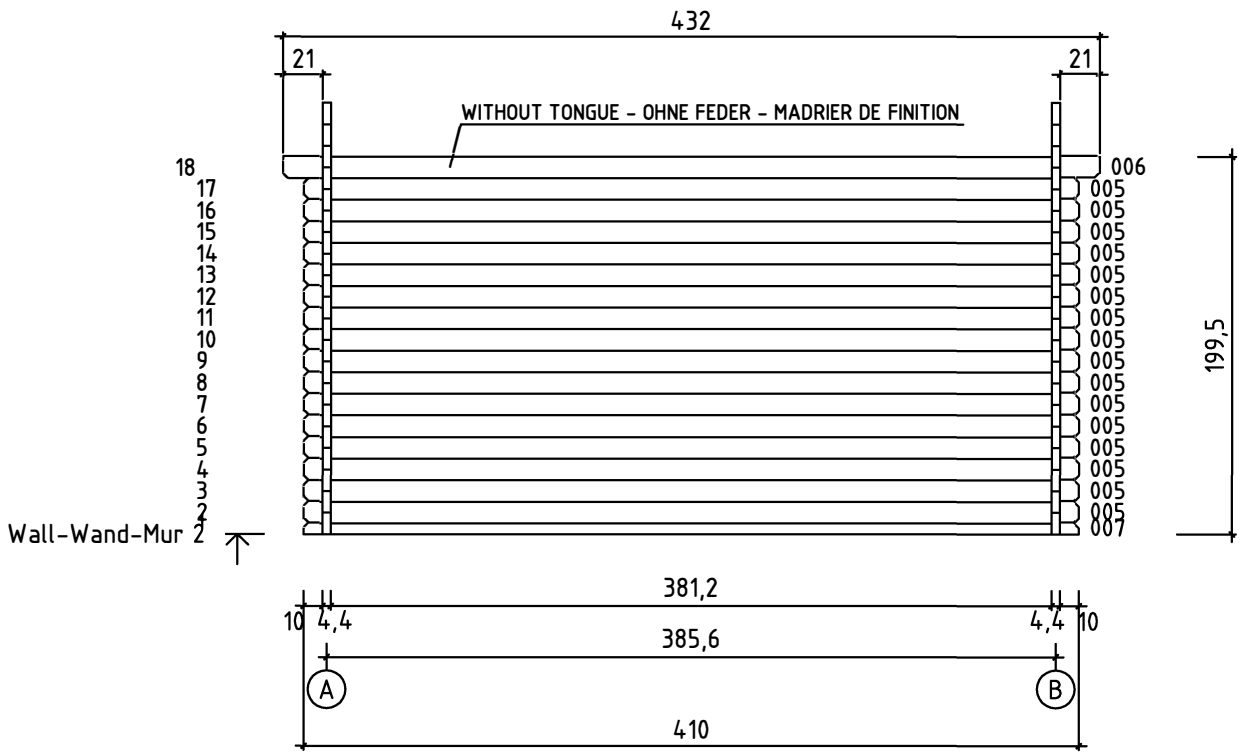





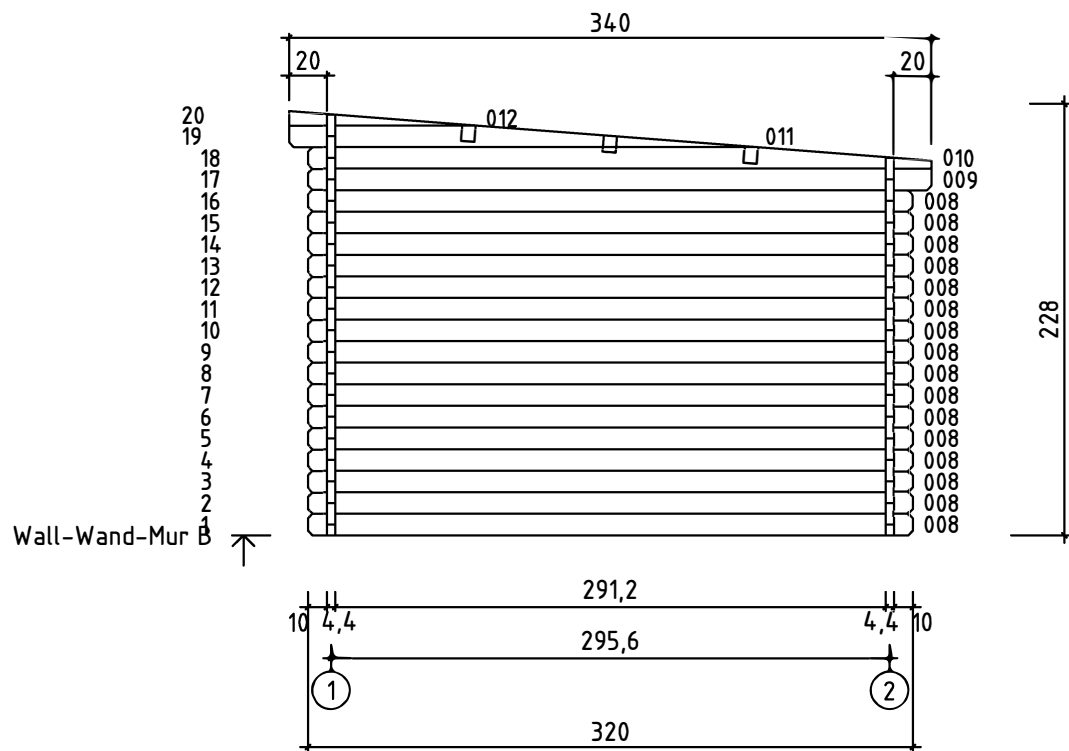
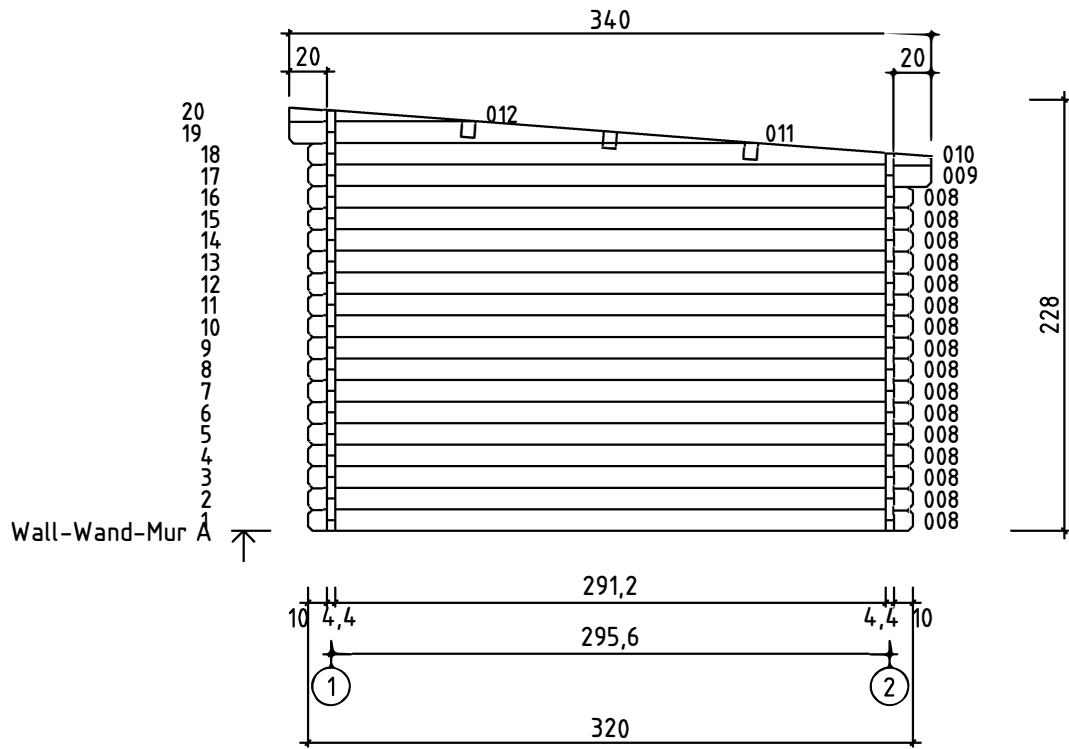

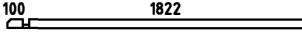

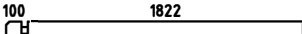

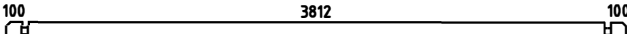
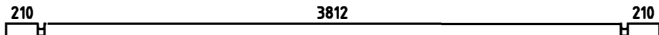
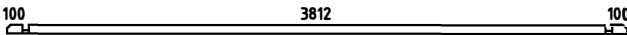
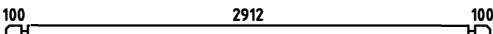
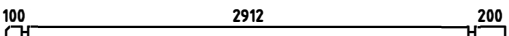
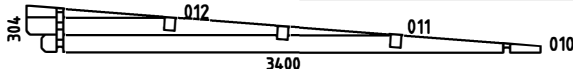
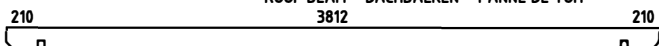

20  
19  
18  
17  
16  
15  
14  
13  
12  
11  
10  
9  
8  
7  
6  
5  
4  
3  
2  
1



Wall-Wand-Mur

18  
17  
16  
15  
14  
13  
12  
11  
10  
9  
8  
7  
6  
5  
4  
3  
2

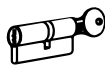

Pos	07.05.2019	Piece list - Stückliste - Liste des pièces Art.Nr. 4.09199.2	Q	P (mm)	L (mm)
001			1	44x57	1966
002			1	44x57	538
003			17	44x114	1966
004			17	44x114	538
005			17	44x114	4100
006			2	44x114	4320
007			1	44x57	4100
008			32	44x114	3200
009			2	44x114	3300
WA-1 WB-1			1 1		
A-PR1			3	70x140	4320
HS1	SCREW FOR GEORGIAN BARS - SCHRAUBE FÜR SPROSSEN - VIS DE BARRES GEORGIENNE 		12	2.5x20	
HS4	SCREW FOR DOOR FILLET - SCHRAUBE ZUR BEFESTIGUNG TÜRLEISTE - VIS POUR FIXATION BAGUETTE D'ARRET DE PORTE 		5	3x30	
HS18	SCREW FOR ROOF BEAMS - SCHRAUBEN FÜR DACHBALKEN - VIS POUR FIXATION PANNES DE TOIT 		10	5x120	
HS18	SCREW FOR GABLE - SCHRAUBEN FÜR GIEBEL - VIS POUR FIXATION DES PIGNONS 		12	5x120	
HS16	SCREW FOR DOOR JAMB - SCHRAUBE FÜR TÜRRAHMEN - VIS DE FIXATION PARTIE HAUTE AVEC MONTANTS DU CADRE DE PORTE 		4	5x90	
HS25	SCREW FOR DOORSTEP - SCHRAUBEN FÜR SWELLE - VIS POUR FIXATION BARRE DE SEUIL 		3	4.5x65	
SH44	HAMMER BLOCK - SCHLAGHOLZ - CALLE DE FRAPPE 		1		
TL4	DOOR HANDLE FITTINGS - TÜRGRIF - POIGNEE DE PORTE 		1		
TL5	SET OF DOOR LOCK COVERS - SCHLOSSBLENDEN - SET DE GARNITURES DE PORTE 		1		
	CYLINDER LOCK - ZYLINDERSCHLOSS - BARILLET DE PORTE 		1	30/35	
	MALE BOLT HINGE FOR DOOR - TÜRRIEGEL - PARTIE MALE DE PAUMELLE DE PORTE 		6	16/52	
	DOOR - TÜR - PORTE 1588x1957 SGC  TUK.2.056.SVP.MM		1		

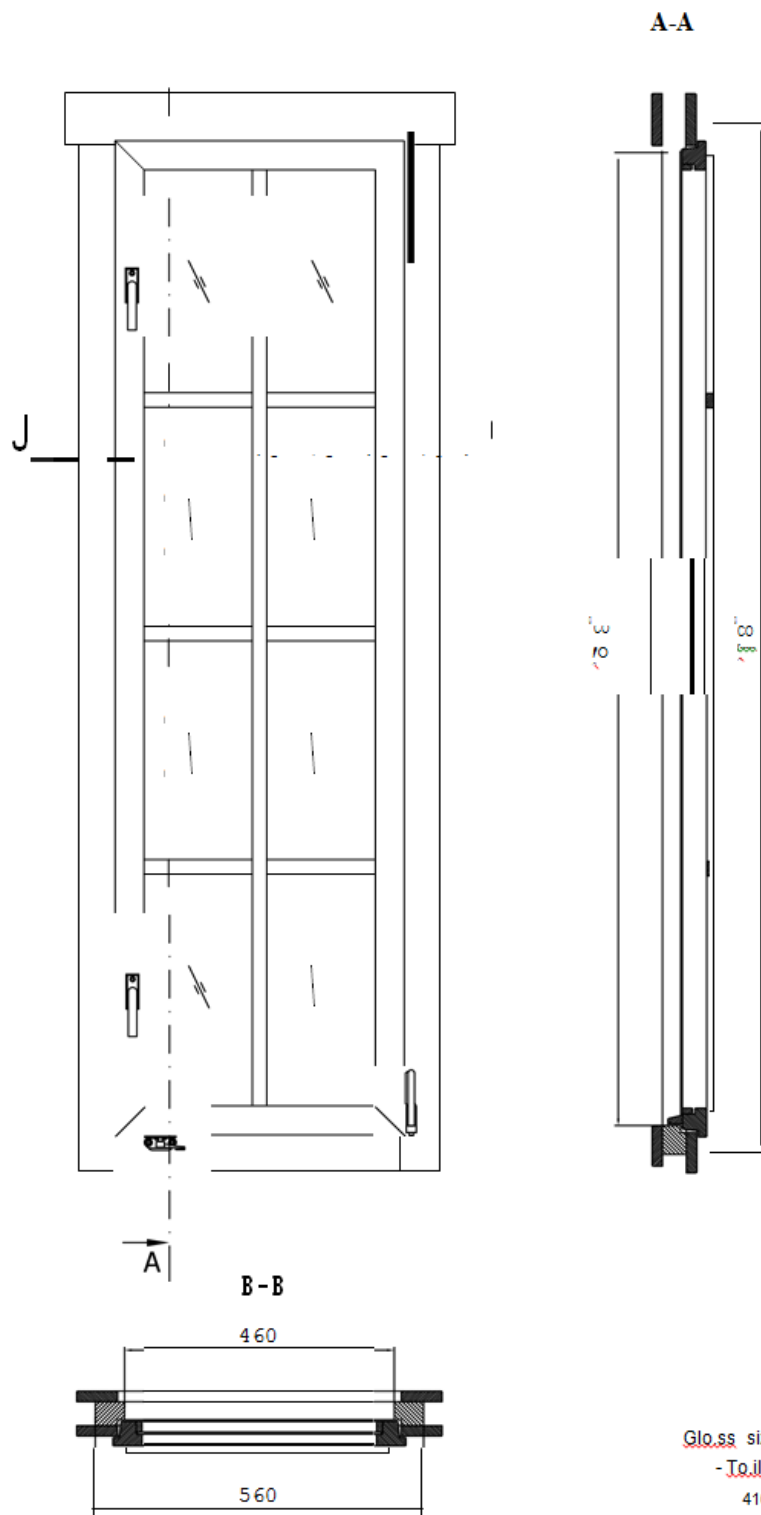

Gloss size - Glasgröße -  
 - Toile cie lo. vitre:  
 416x1636 MM

Die nachfolgende Anleitung ist allgemein gehalten  
für verschiedene Varianten.  
In einzelnen Punkten kann die Montage  
des speziellen Modells abweichen !

## Montageanleitung Dachpaket - Holzdach Gartenhaus Lugano 28 / 34 / 44

### 1.) Aufbringen der Dachbretter auf die Pfetten durch verschrauben mit Spanplattenschrauben

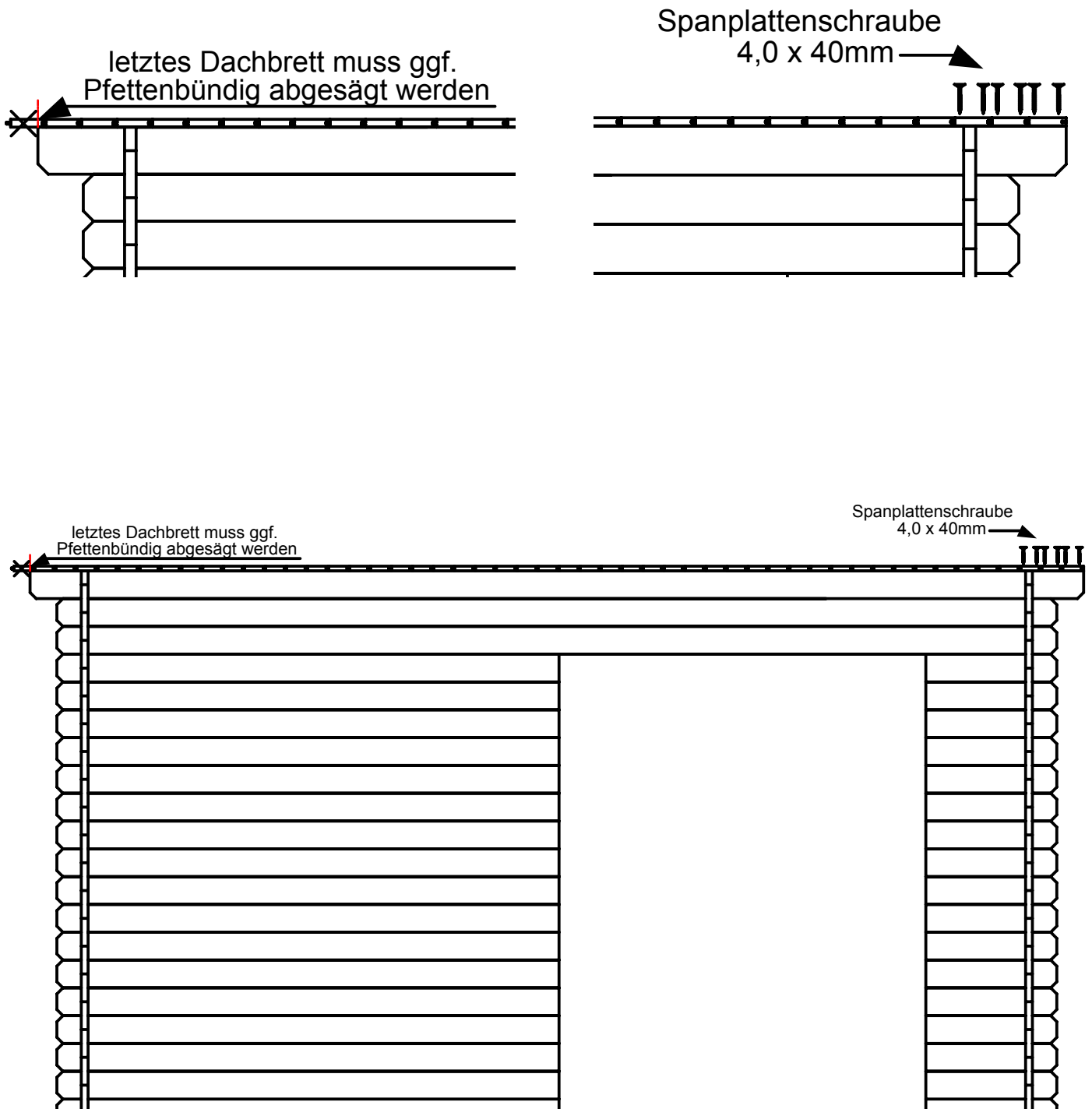



## 2.) Aufbringen der Dachbretter auf die Pfetten durch verschrauben mit Spanplattenschrauben

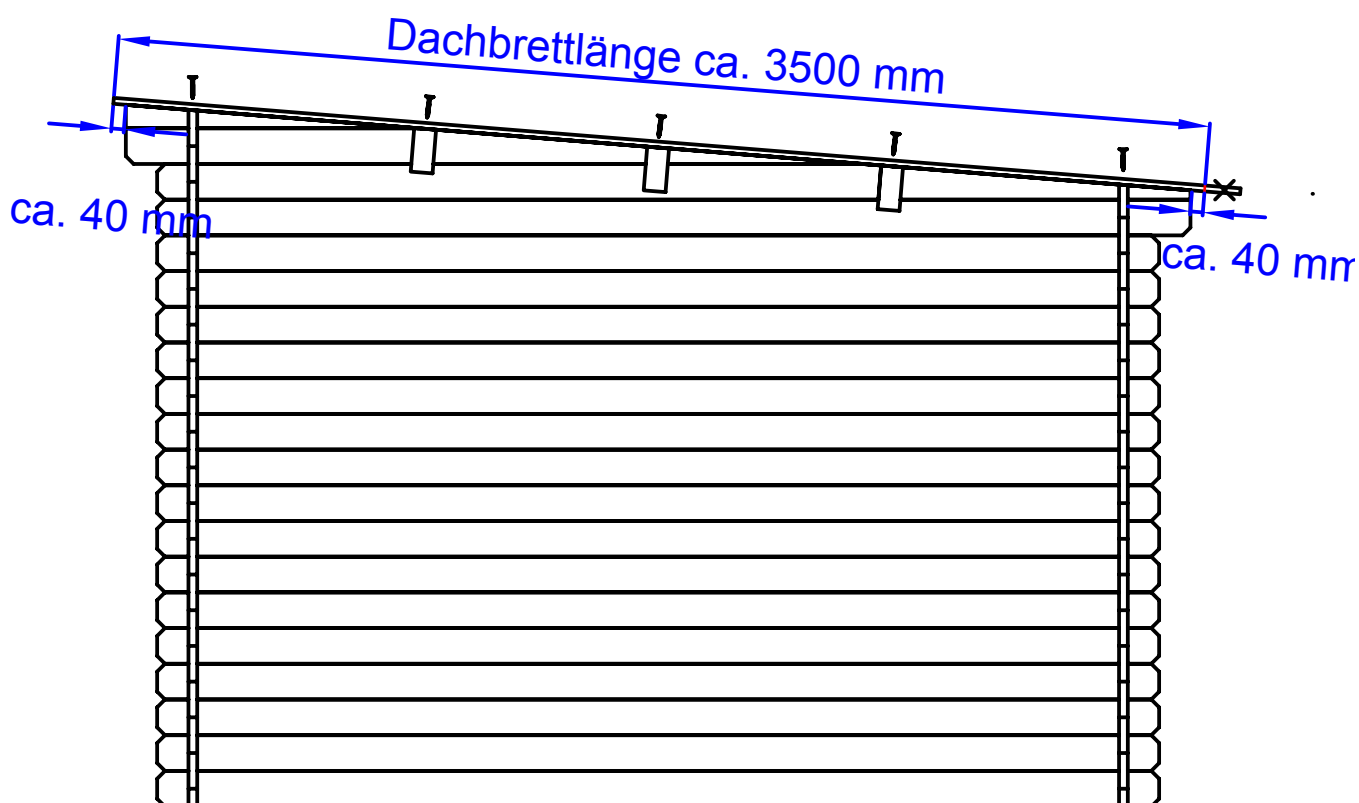
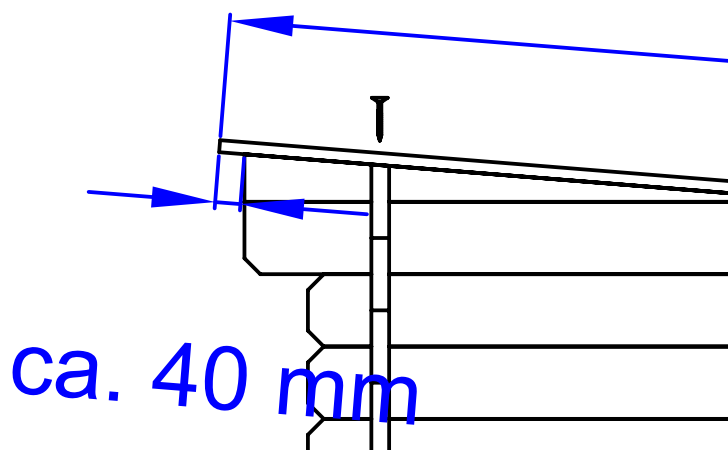

### 3.) Dachbrettlänge bauseitig auf Maß zuschneiden

ca. 3500 mm

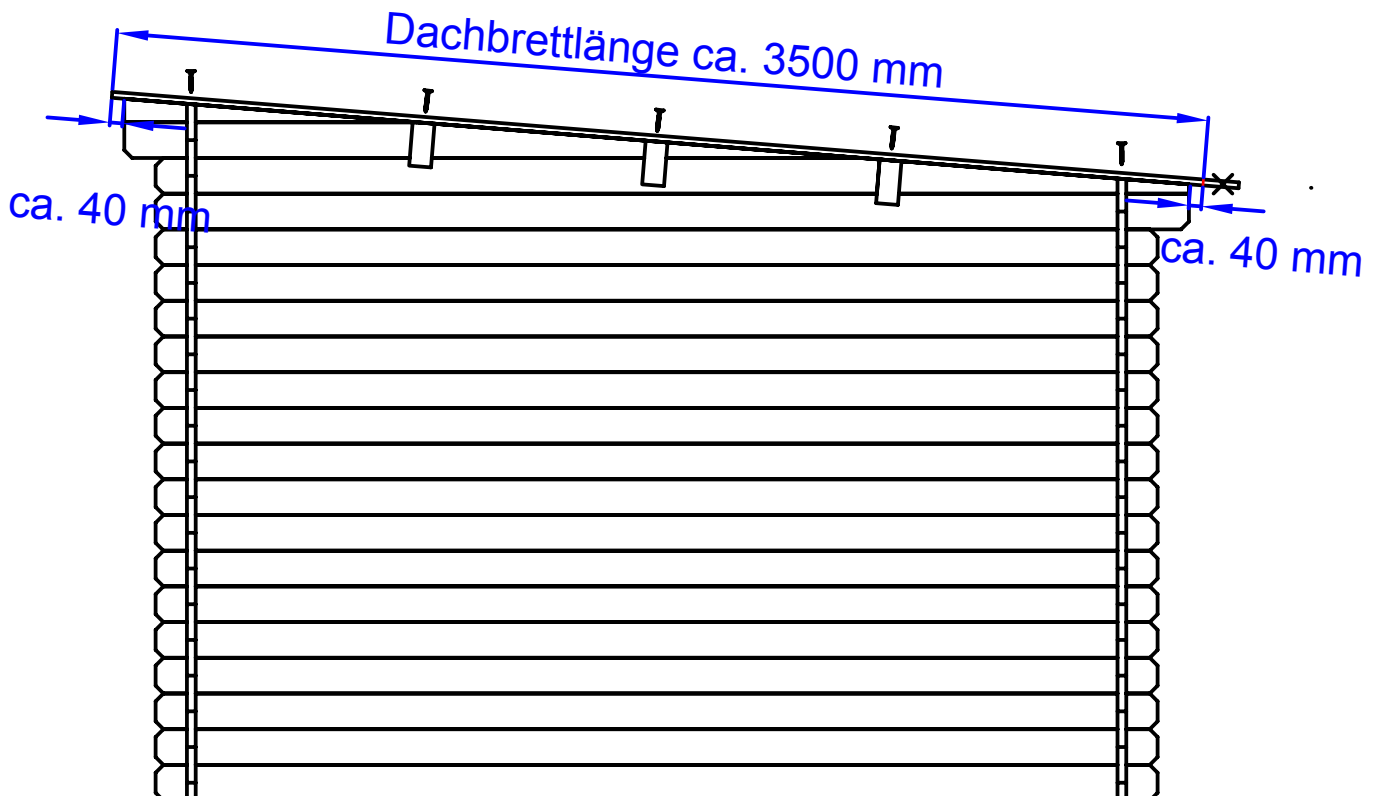
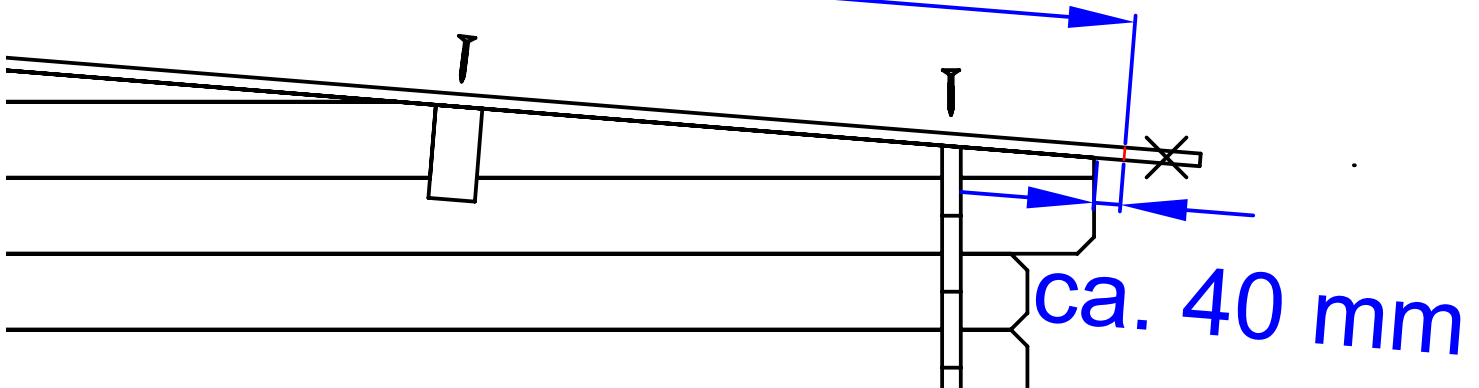

## Montageanleitung Dachpaket - Holzdach Gartenhaus Lugano 28 / 34 / 44

### 4.)

Anbringen der Traufbretter an der  
Vorder und Hinterseite der Dachbretter

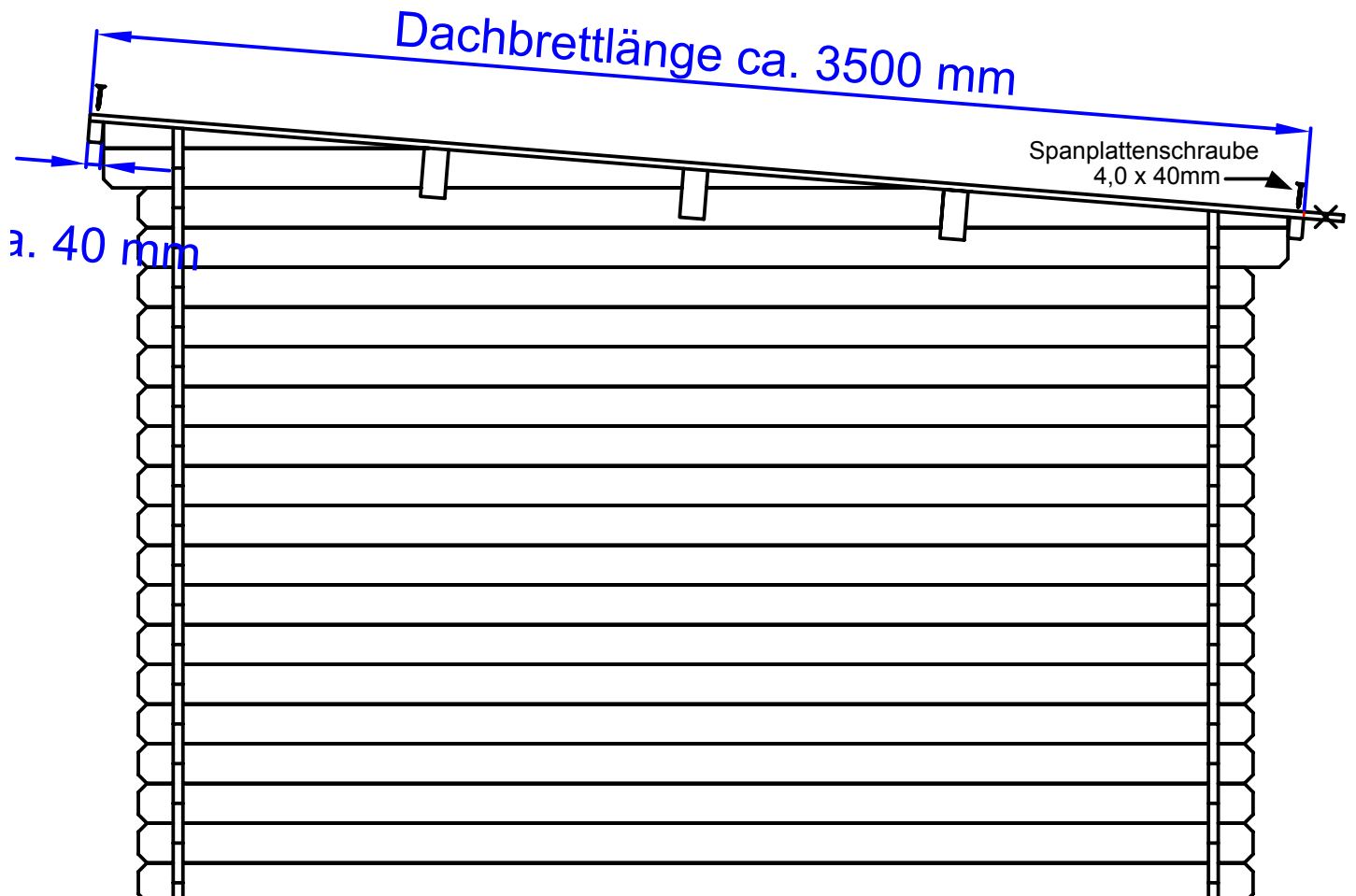
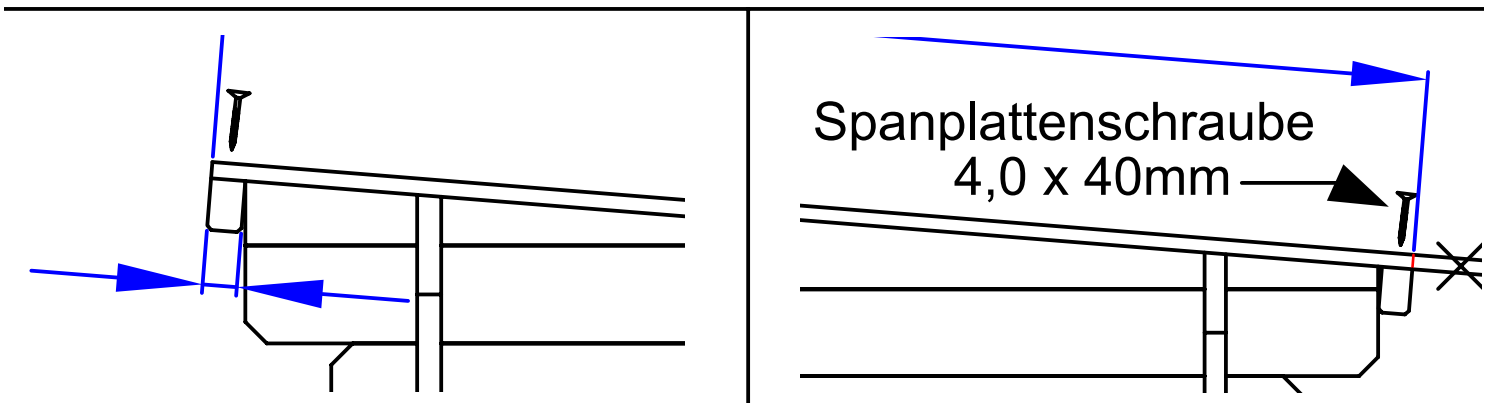

## Montageanleitung Dachpaket - Holzdach Gartenhaus Lugano 28 / 34 / 44

- 5.)** Ausrollen der Dachpappe und befestigen mit Dachpappstifte quer zum Dachbrett von der Traufe Richtung First mit ca. 10cm Überlappung

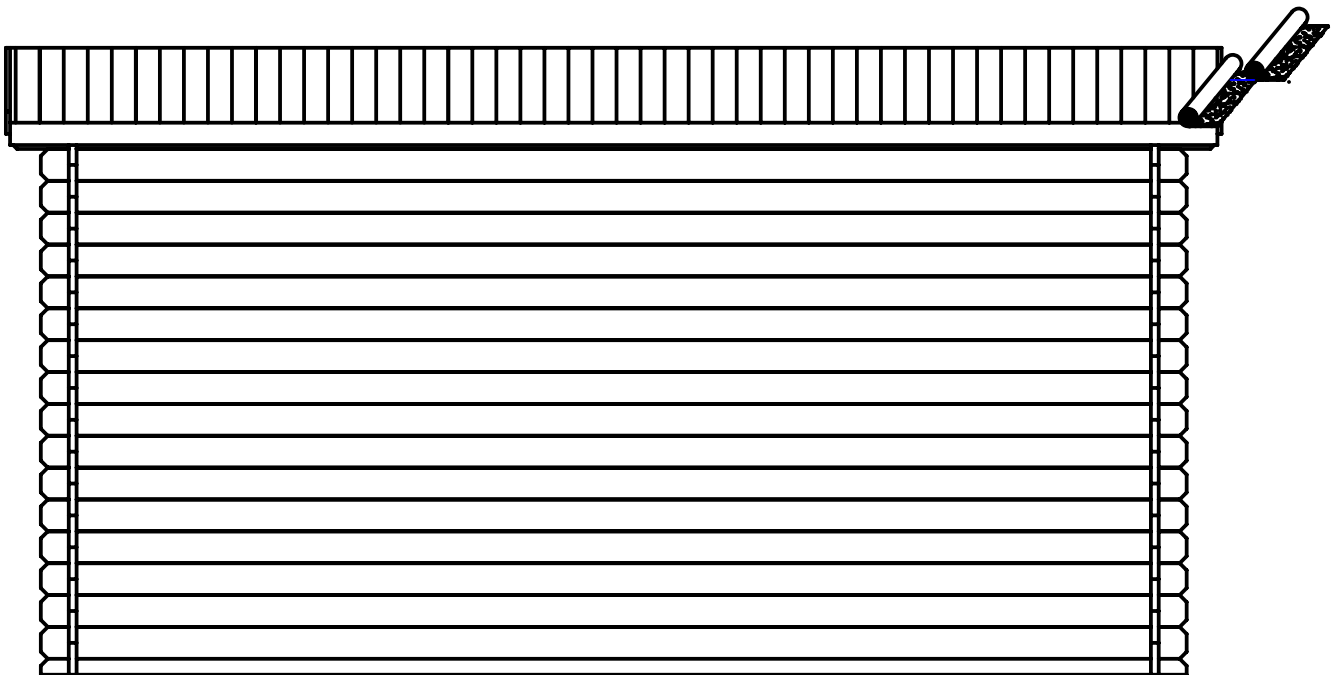
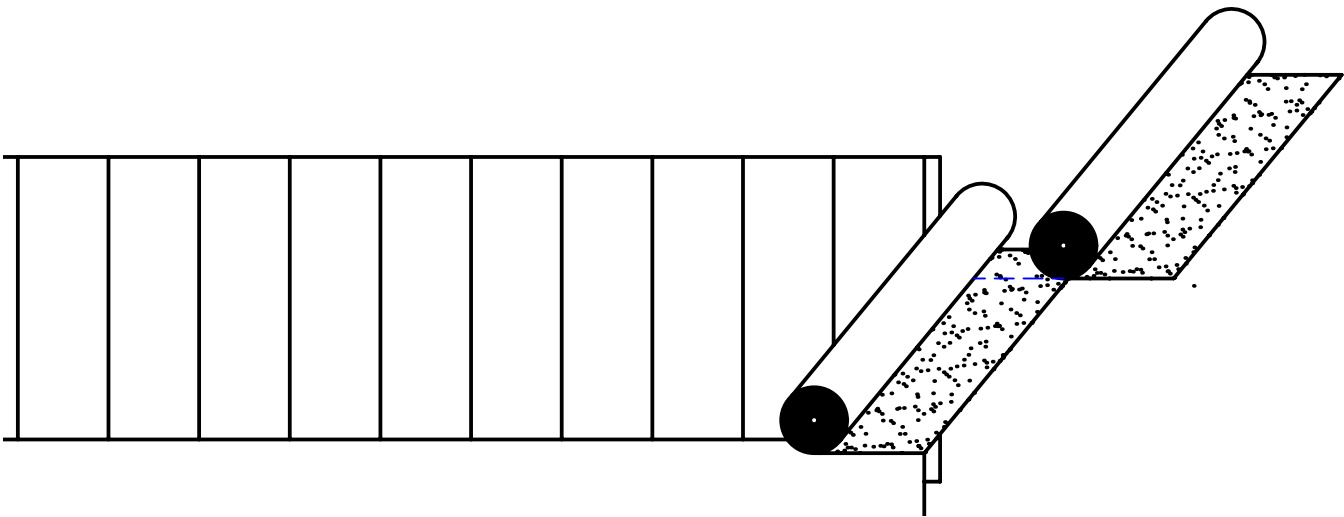

## 6.) Montage der Holzblende bündig mit der Lattenoberkante der Querlattung

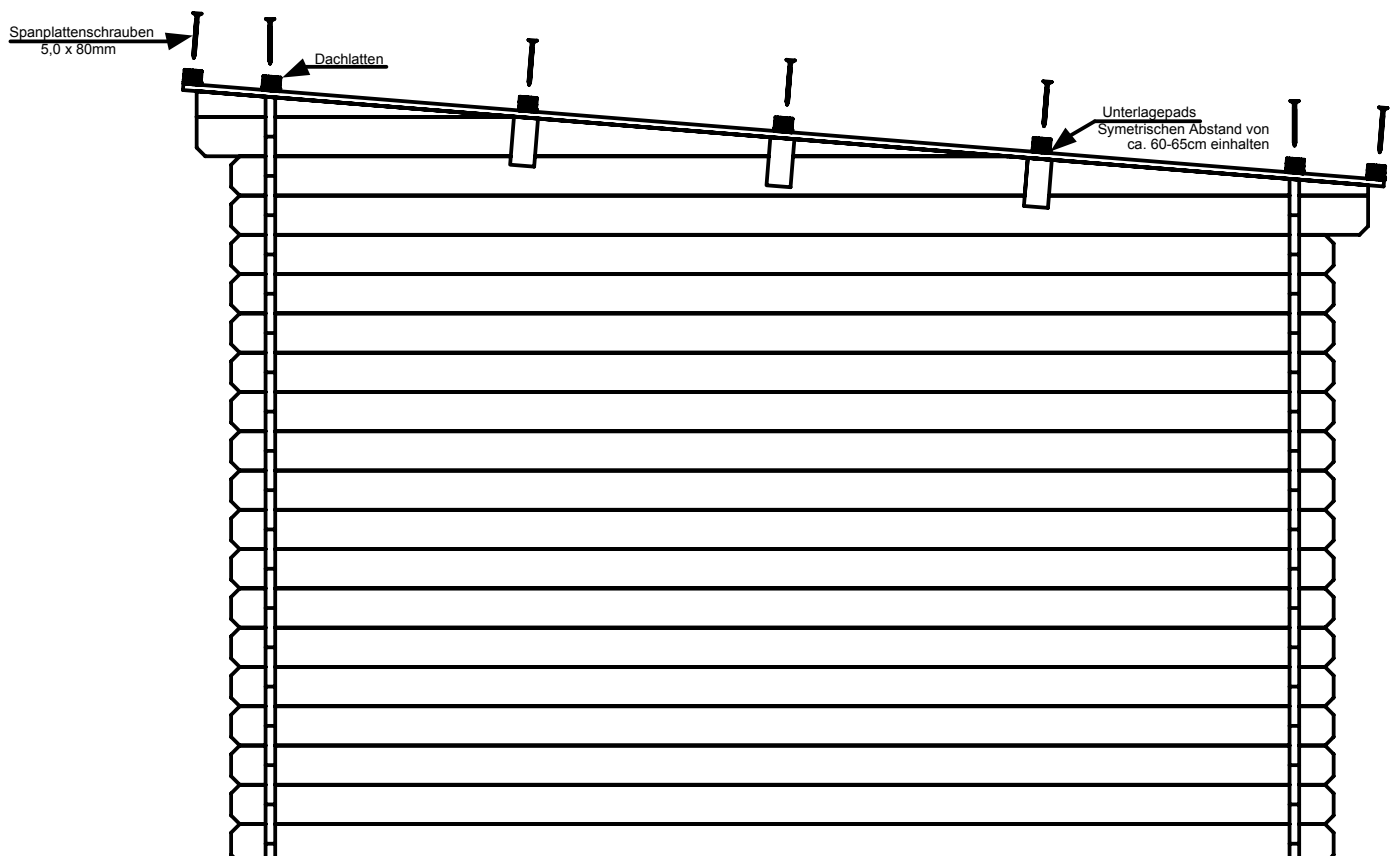
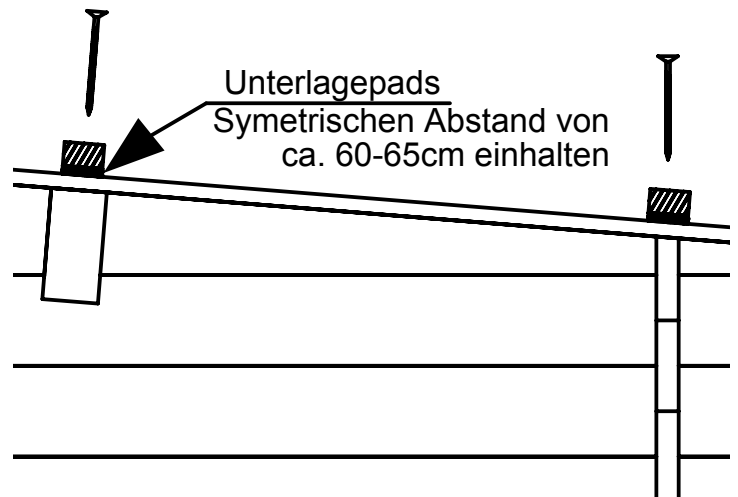
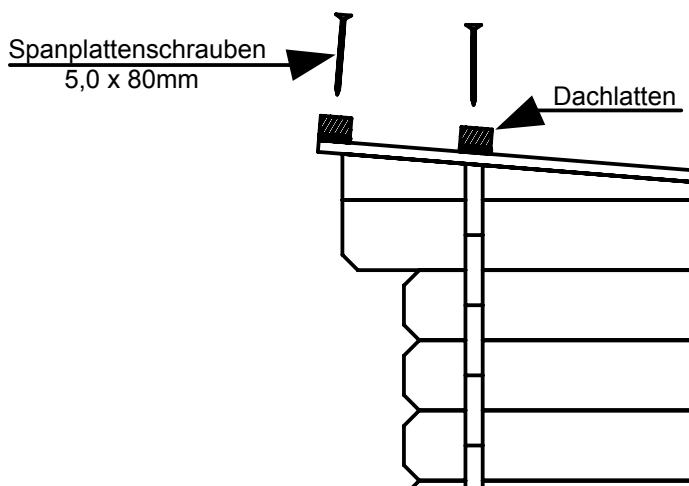

## 7.) Montage der Holzblende bündig mit der Lattenoberkante der Querlattung

### Bündig mit Lattenoberkante

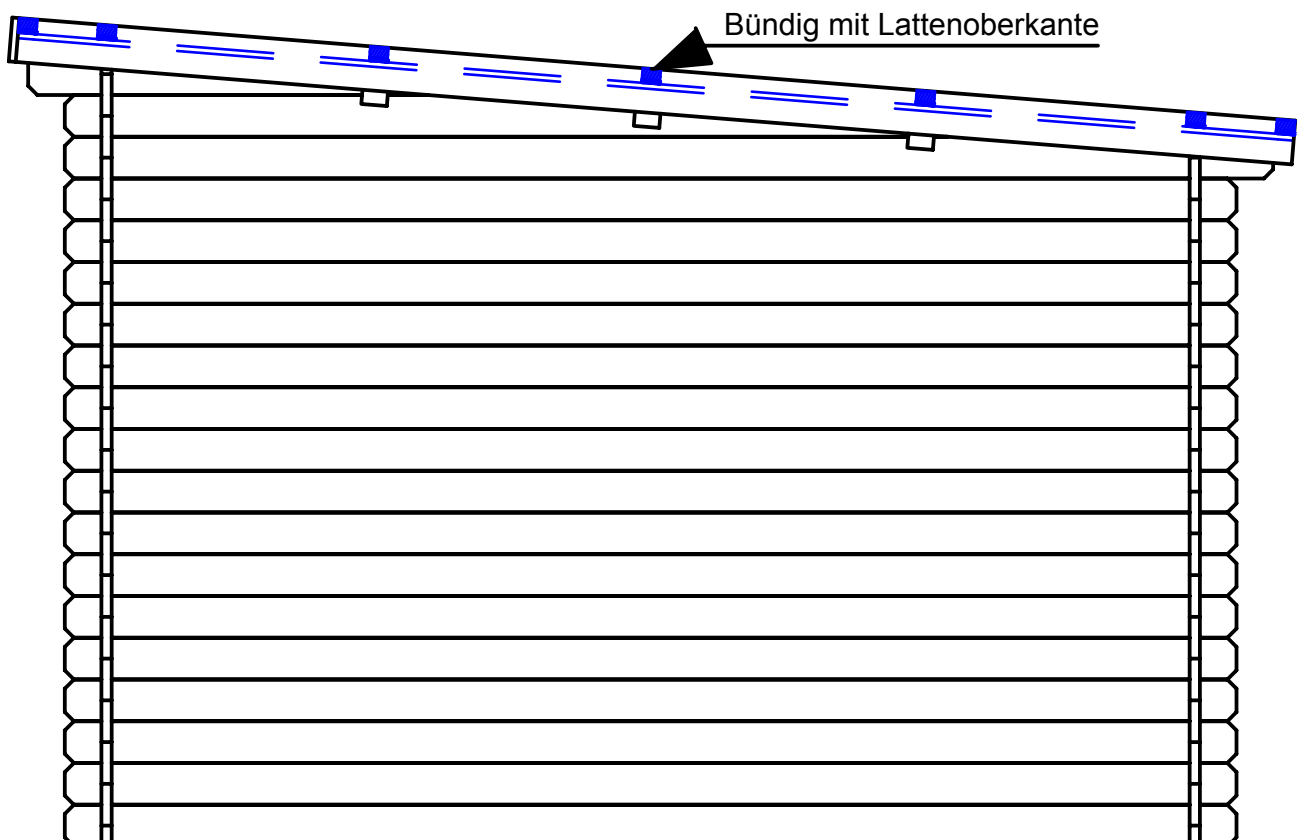
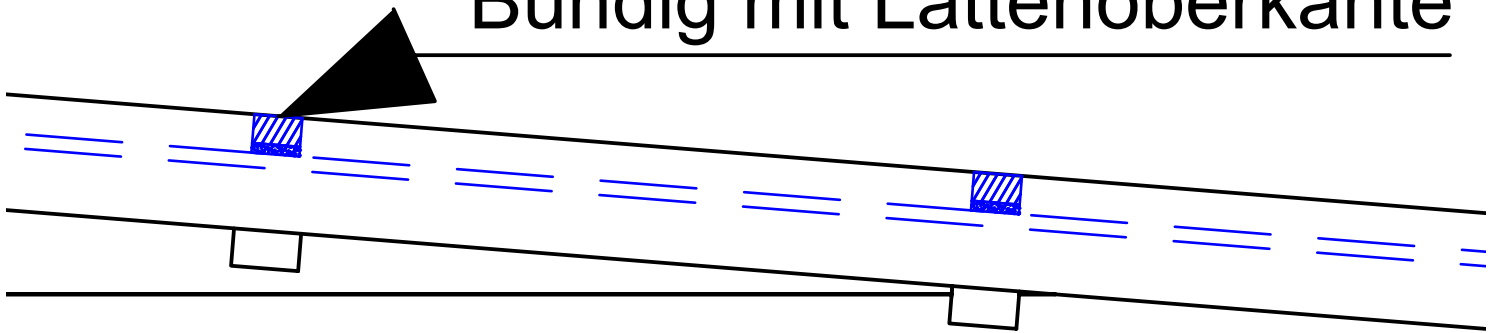

## 8.) Montage der Sichtblende an der Vorderseite

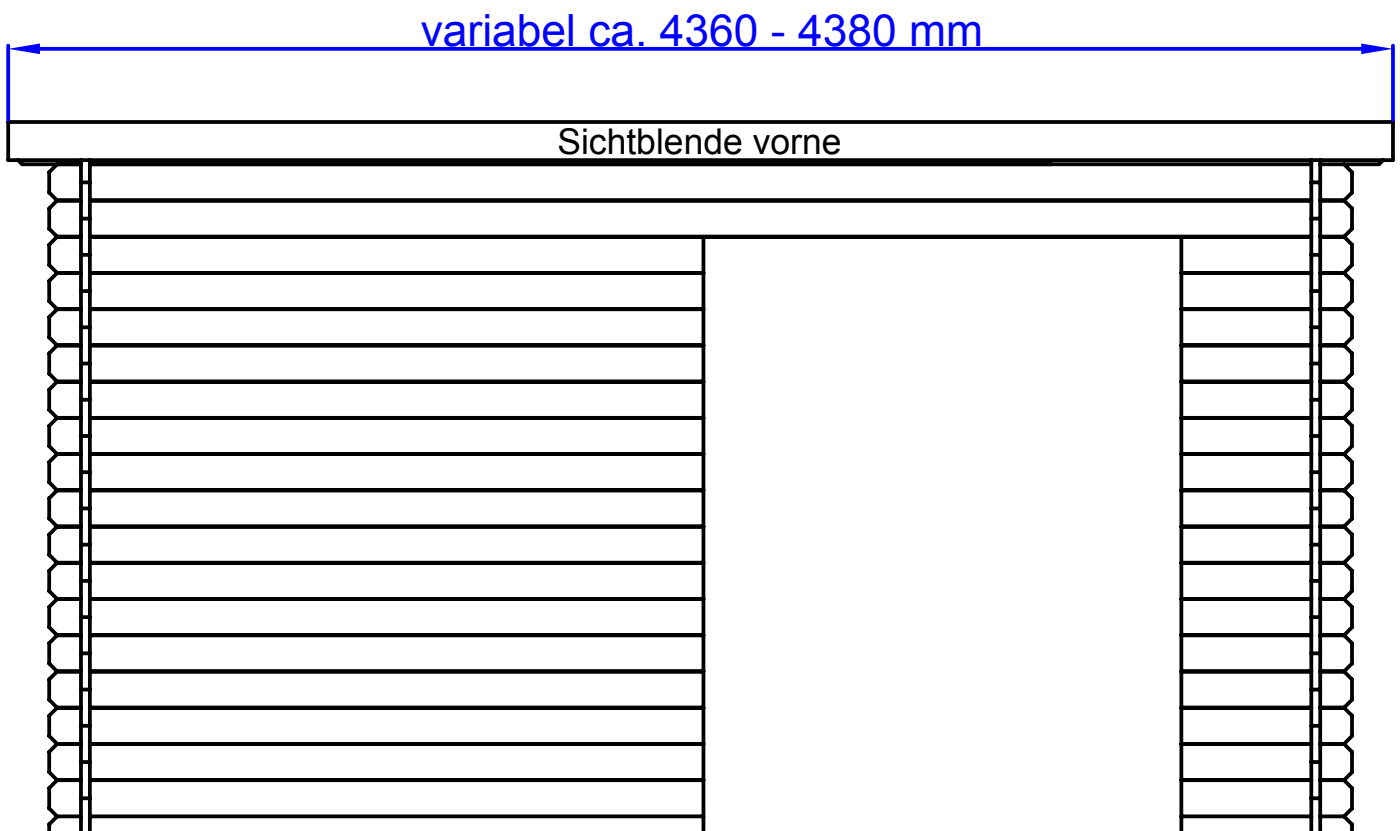

9.) Montageanleitung Dachpaket - Holzdach  
Gartenhaus Lugano 28 / 34 / 44

Gesamtlänge (rechts u

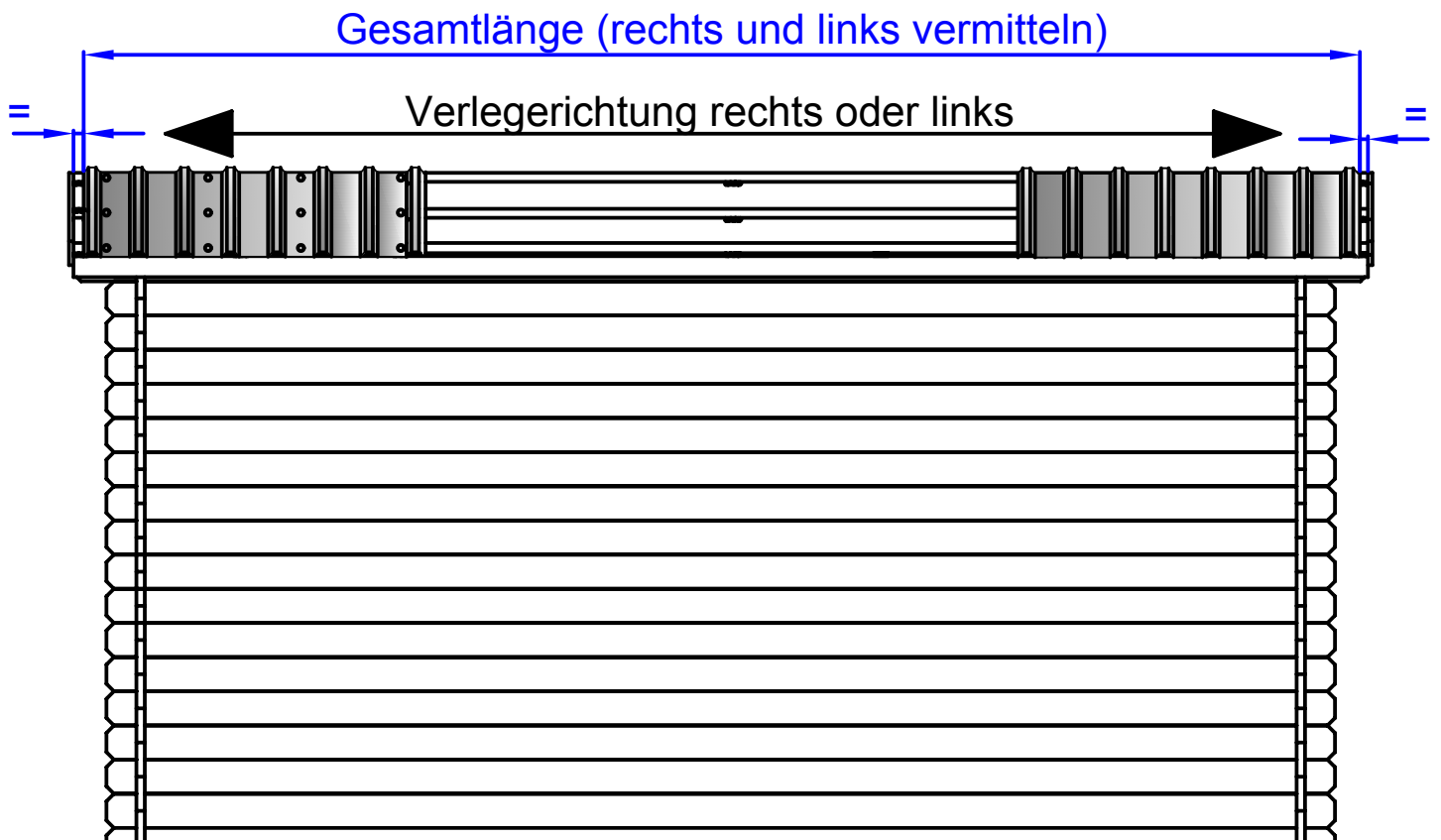
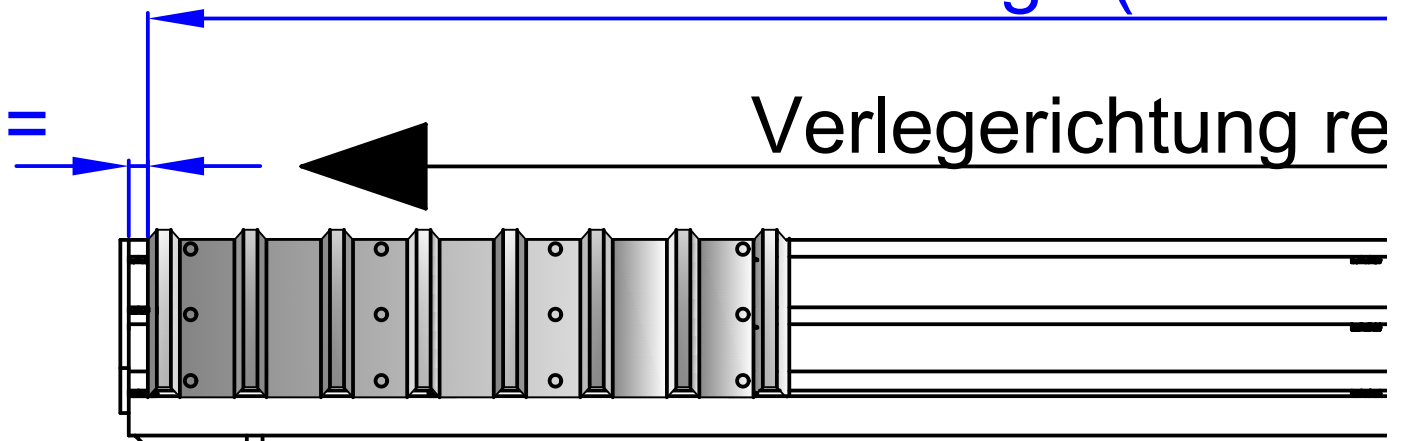



10.) Längenanpassung der Giebelblenden mit Blechschere erfolgt bauseitig, falls notwendig Gehrungsschnitt

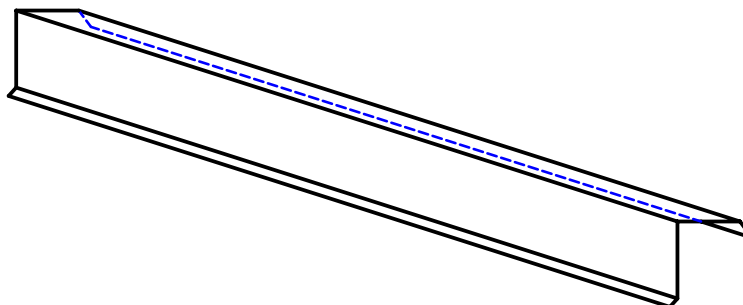
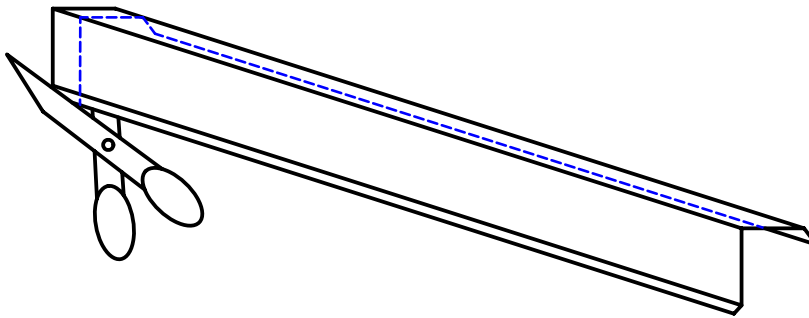
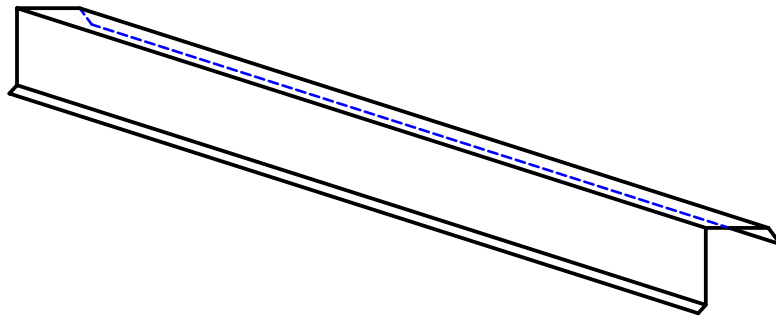

## Montageanleitung Dachpaket - Holzdach Gartenhaus Lugano 28 / 34 / 44

# 11.)

Montieren der Giebelbleche durch verschrauben  
mit Bohrschrauben Blech in Blech 4,8 x 20mm

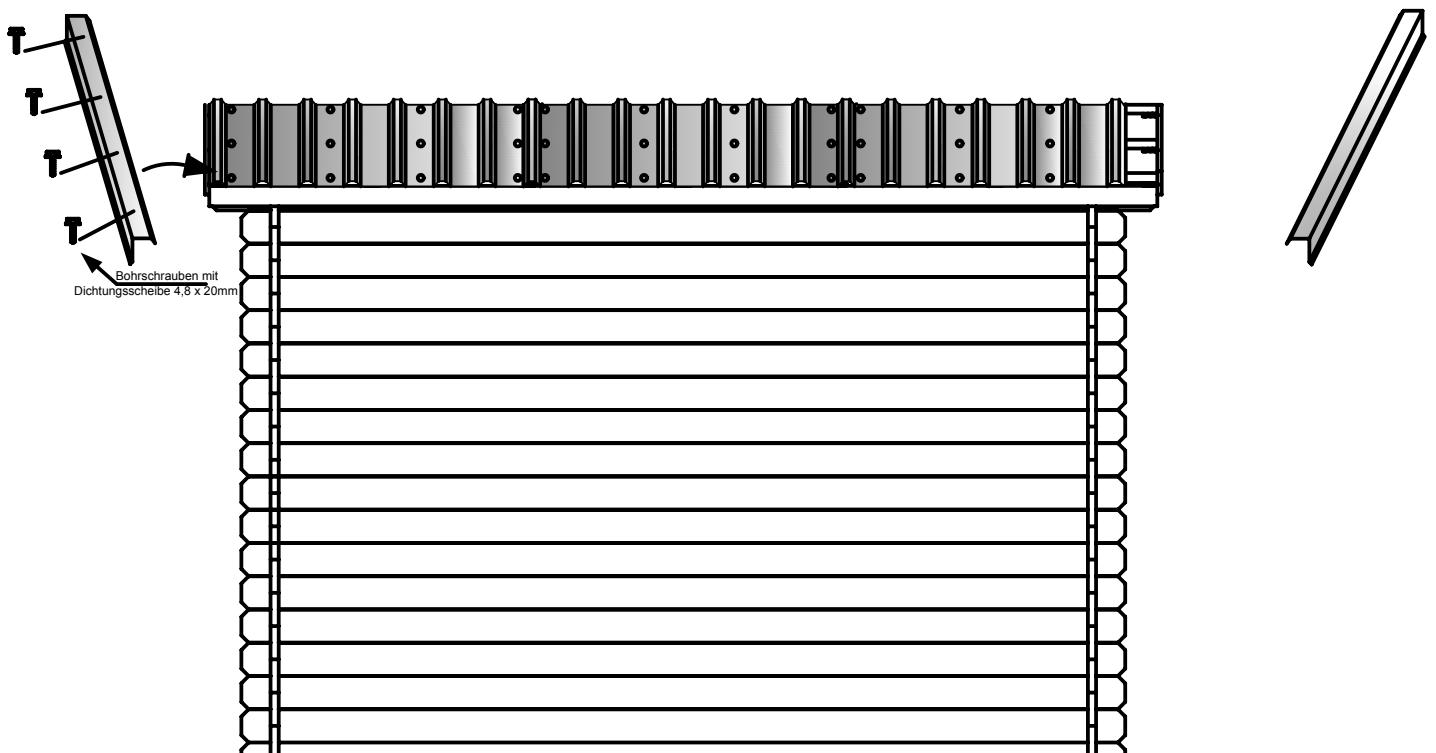
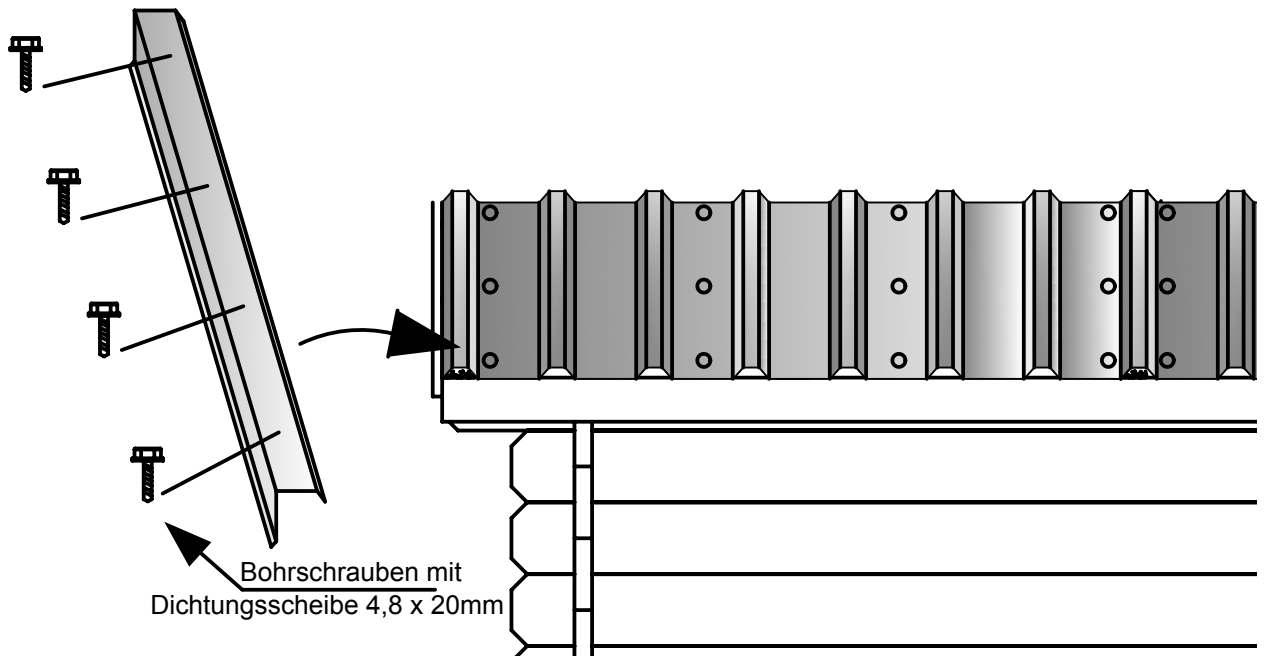

## Montageanleitung Dachpaket - Holzdach Gartenhaus Lugano 28 / 34 / 44

# 12.)

Montieren der Giebelbleche durch verschrauben  
mit Bohrschrauben Blech in Blech 4,8 x 20mm

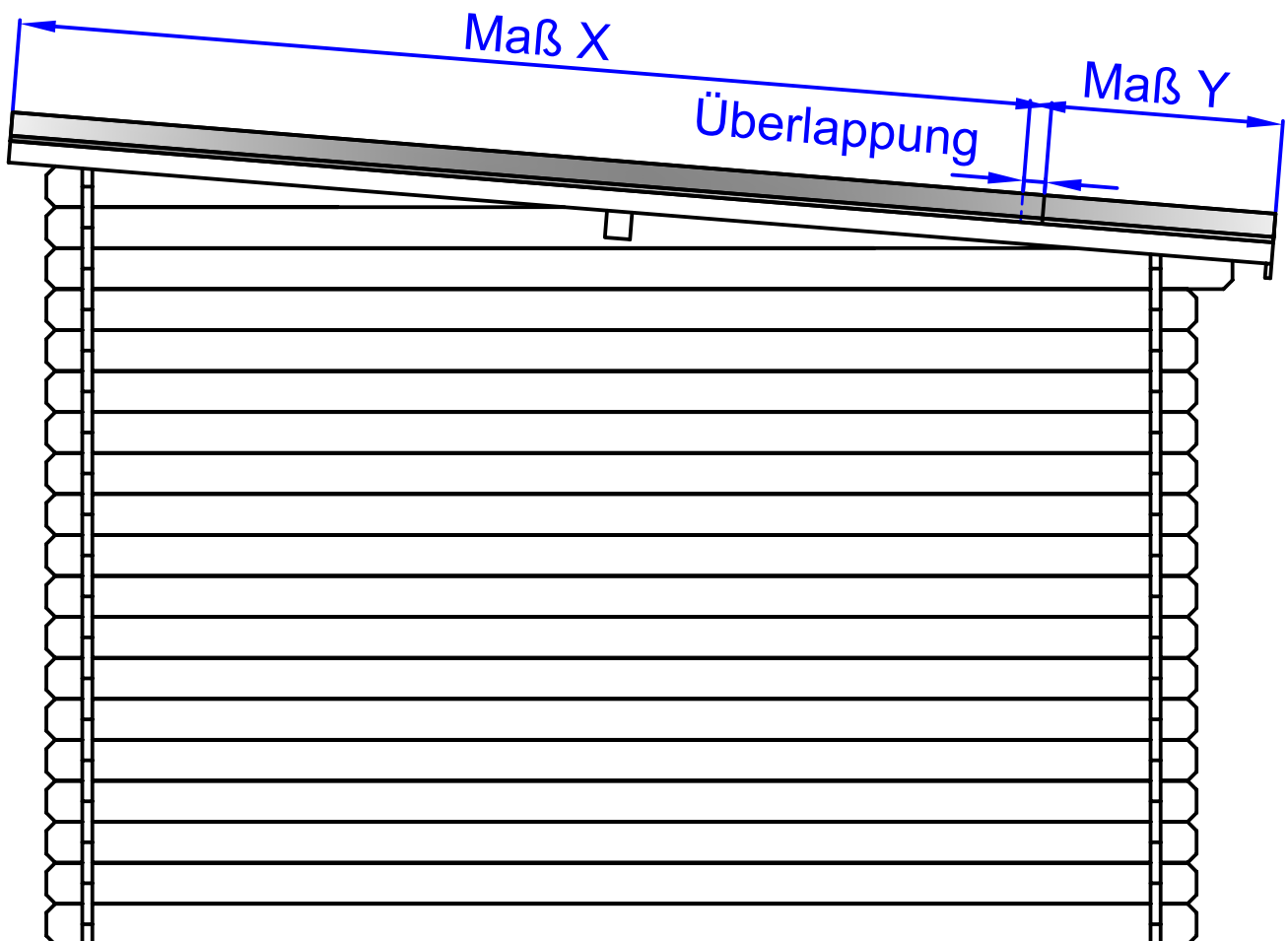

# 13.) Profilfüllermontage

Profilfüller oben zur Montage unter das Pultabschlussblech

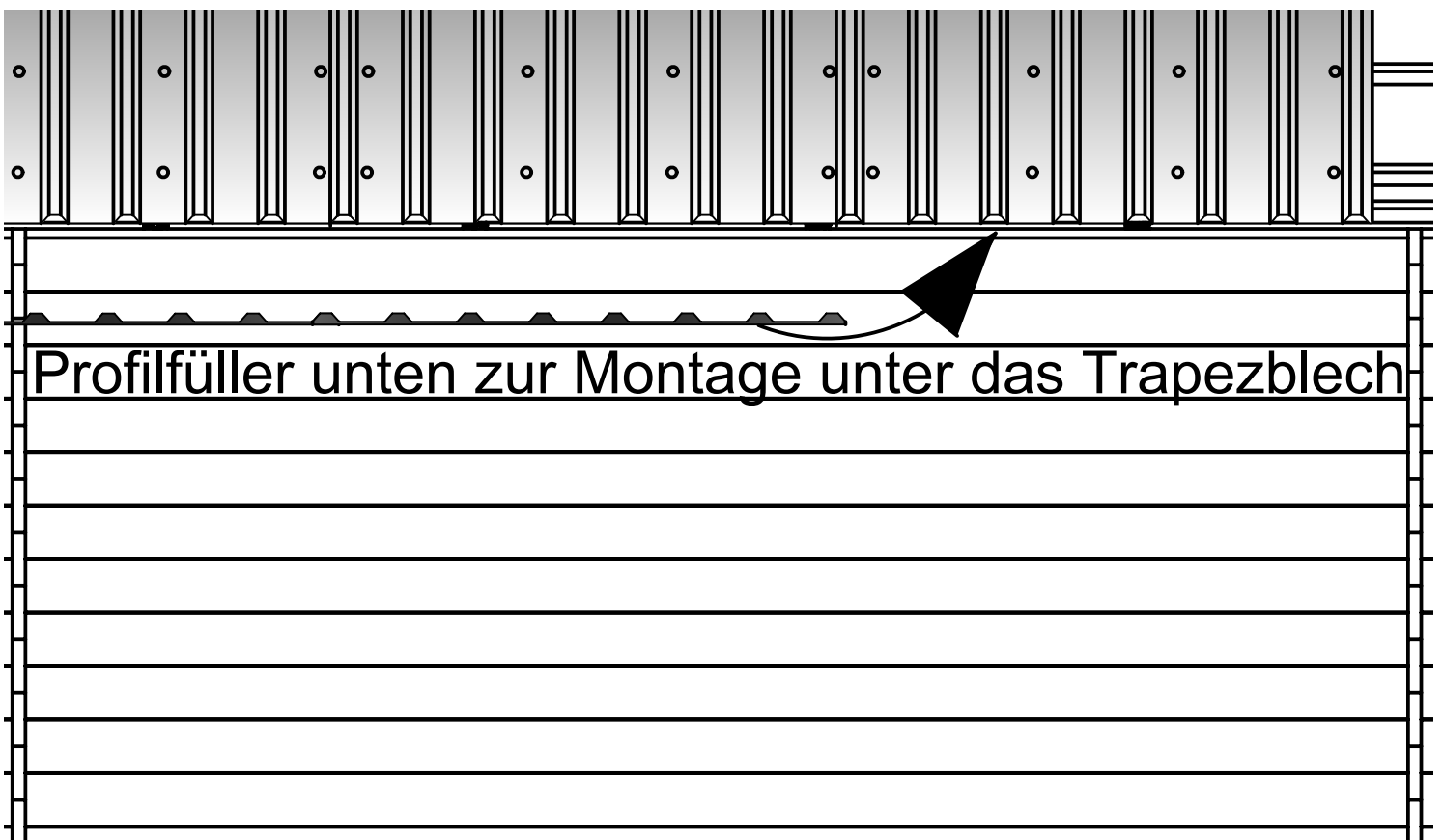
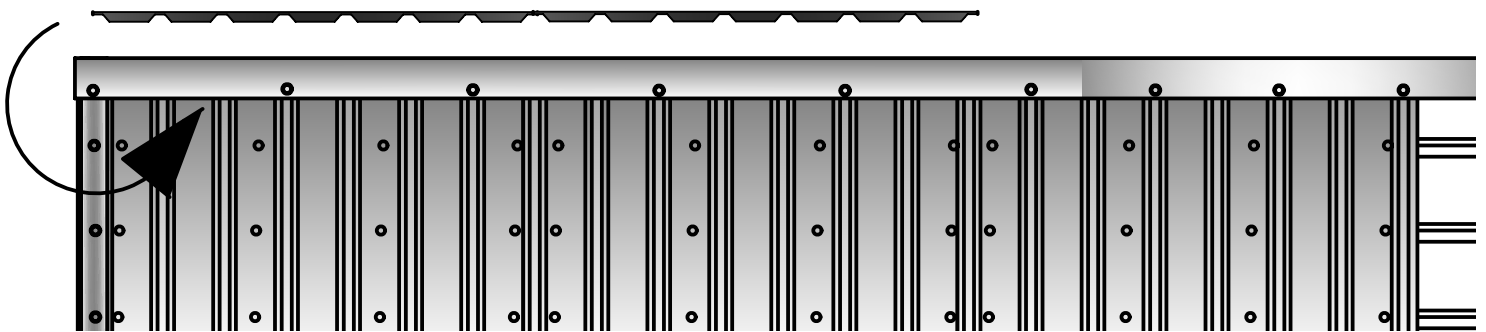

Montageanleitung Dachpaket - Holzdach 13.)  
Gartenhaus Lugano 28 / 34 / 44

## 14.) Pultabschlussblechmontage mit Bohrschrauben

Blech in Blech

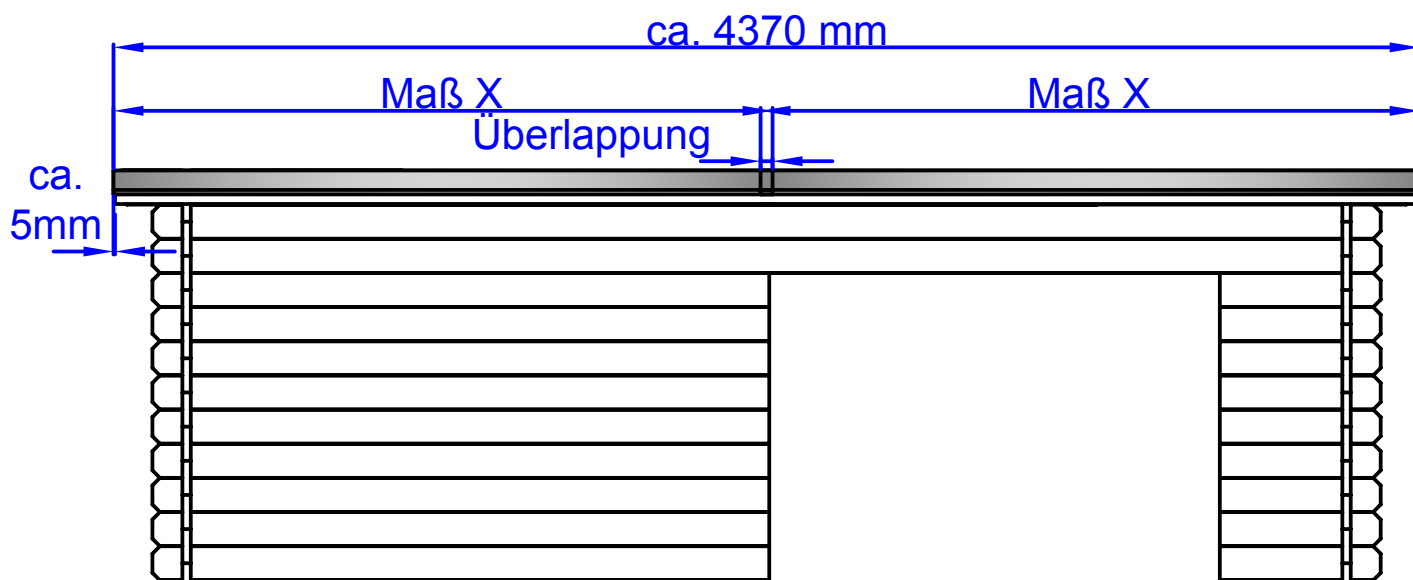
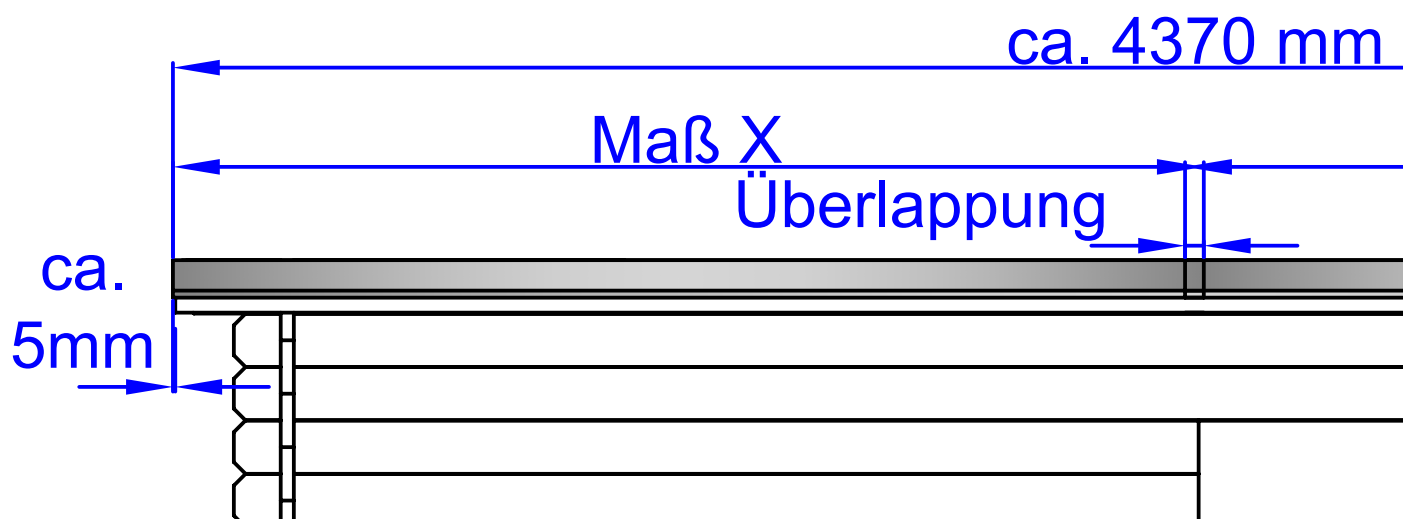

Montageanleitung Dachpaket - Holzdach  
Gartenhaus Lugano 28 / 34 / 44

**15.)** Pultabschlussblechmontage mit Bohrschrauben  
Blech in Blech

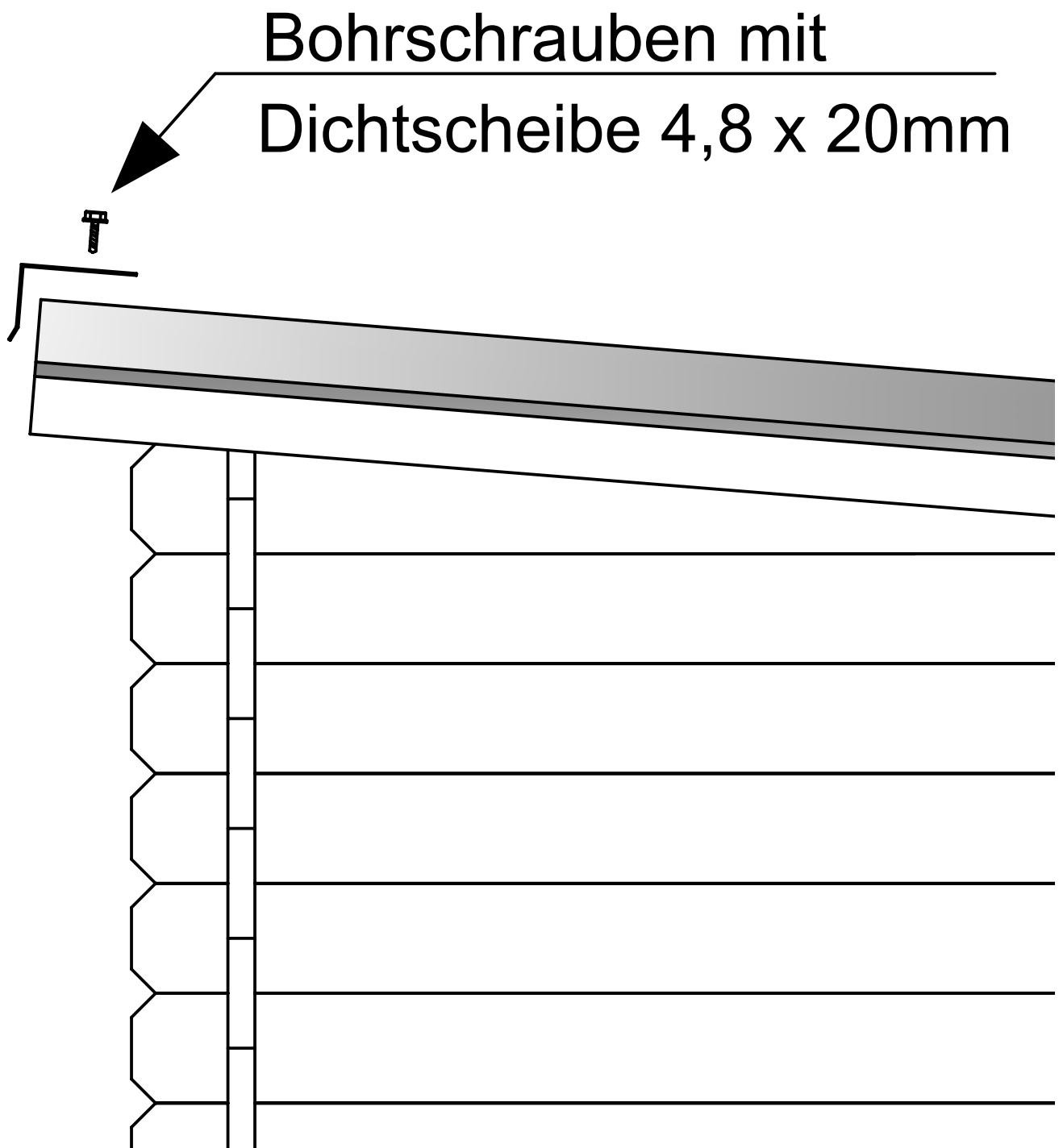

## Montageanleitung Dachpaket - Holzdach Gartenhaus Lugano 28 / 34 / 44

### 16.) Montage Lüftungsgitter mit Spenglerschrauben 4,5 x 25mm

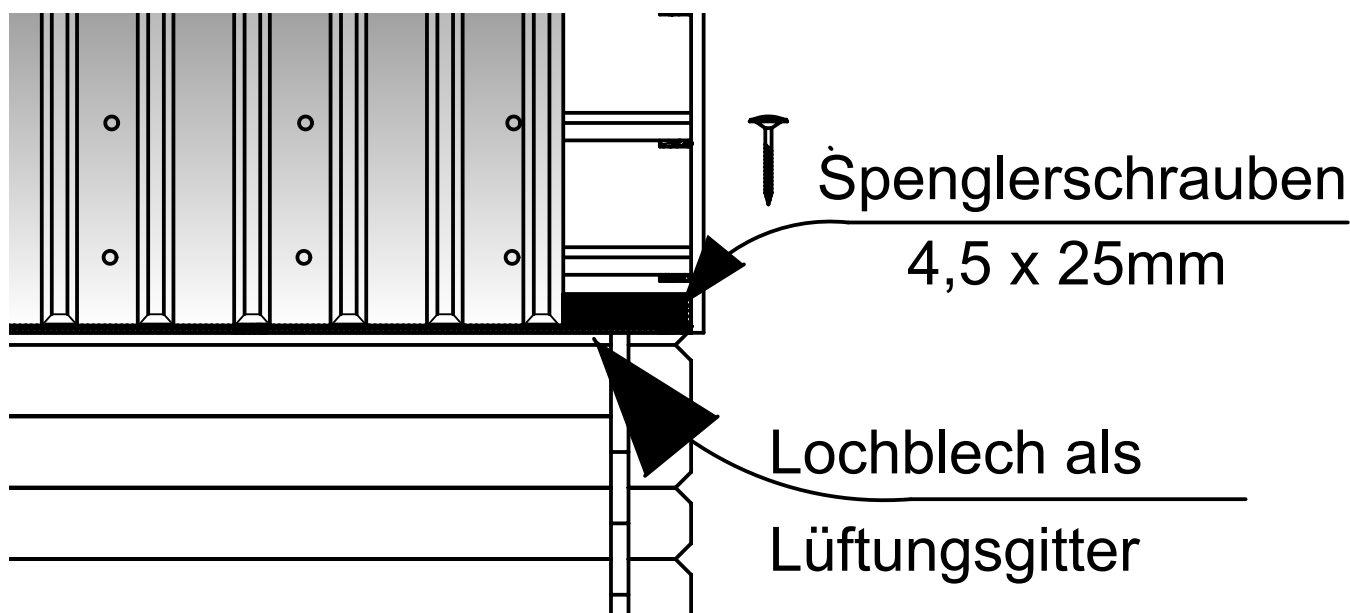
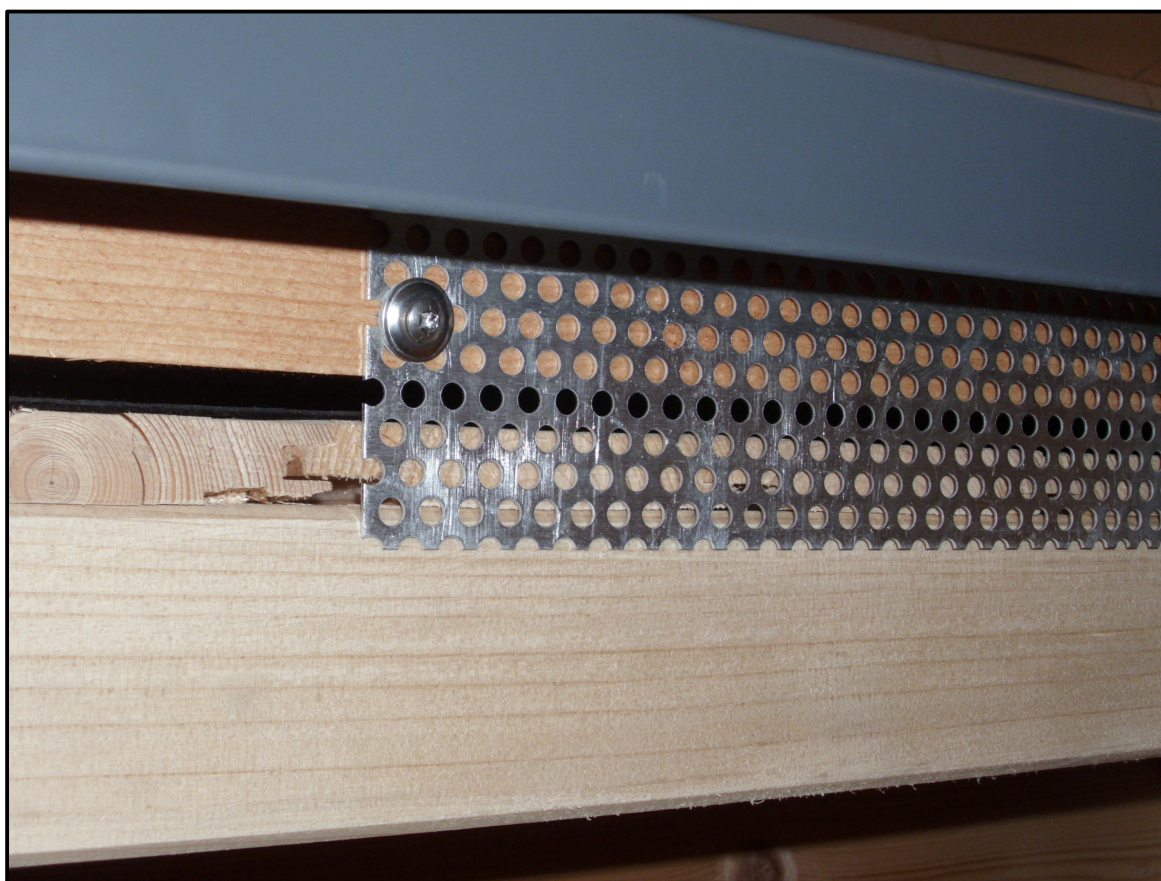

# Stückliste Lugano Holz + Blechdach

- 1-3.) 39 Stck. Softline Profilbretter 16 x 121 x 3600 mm.  
Längenzuschnitt erfolgt bauseitig!
- 4.) 2 Stck. Traufbretter Länge 4360 mm.
- 5.) 2 Rollen Dachpappe R333
- 6.) 7 Stck. Dachlatten ca. 30 x 50 x 4500mm Länge imprägniert.
- 6.) 1 Stück Re-Fix Granualtrole a 5,00 m (selbstklebend)  
Zuschnitt erfolgt bauseitig! zu ca. 56 Stck. Pads ca. 50 x 60 mm
- 7.) 2 Stck. Glattkantbrett (Holzblende) 18 x 120 x 3500 mm.  
Längenzuschnitt erfolgt bauseitig, falls nötig!
- 8.) 2 Stck. Glattkantbrett (Sichtblende Vorderseite) 18 x 120 x 4380 mm.  
Längenzuschnitt erfolgt bauseitig, falls nötig!
- 9.) 4 Stck. Trapezbleche 20/100 Länge 3550 mm x Stärke 0,5 mm
- 10-12.) 2 Stck. Giebelbleche ca.15 x 65 x 70 x 20 mm Länge 2500 mm  
2 Stck. Giebelbleche ca.15 x 65 x 70 x 20 mm Länge 1150 mm  
Zuschnitt erfolgt bauseitig, falls nötig!
- 13.) 4 Stck. Profilfüller 20/100 OBEN Länge 1075 mm
- 13.) 4 Stck. Profilfüller 20/100 UNTEN Länge 1075 mm
- 14-15.) 2 Stck. Pultabschlussblech ca.15 x 65 x 120mm Maß X = 2240 mm
- 16.) 3 Stck. Lochblech ALU Stärke1mm ca. B 60 x L 2000 mm  
Zuschnitt erfolgt bauseitig!

## Befestigungsmaterial:

- zu 1-3.) Spanplattenschrauben optional.
- zu 4;7;8.) 60 Stck. Spanplattenschrauben 4,0 x 40 mm.
- zu 5.) 0,5 kg Dachpappstifte 15 mm Länge.
- zu 6.) 60 Stck. Spanplattenschrauben 5,0 x 80 mm gelb verzinkt.
  
- zu 9.) 100 Stck. Bohrschrauben m.Dichts. 4,8 x 35mm
- zu 9-15.) 50 Stck. Bohrschrauben m.Dichts. 4,8 x 20mm
- zu 16.) 15 Stck. Spenglerschrauben V2A m. Dichts. 4,5 x 25mm  
1 Stck. Bit SW 8



# Fertigungszeichnung Kantenteile

Lugano Holz + Blechdach  
410 x 320 cm

2 Stück Länge 2500mm  
2 Stück Länge 1150mm  
( Z = 170mm )

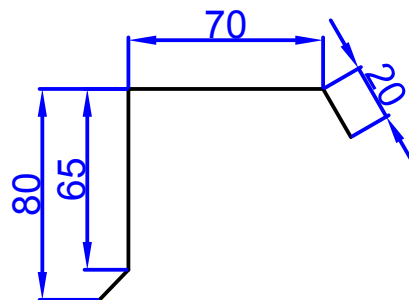

2 Stück Länge 2240mm  
( Z = 200mm )

