

Installation manual

Montageanleitung • Notice de montage • Istruzioni per il montaggio
Manual de montaje • Monteringsanvisning • Installatiegids • Asennusohje • Installationsmanual • Paigaldusjuhend

Element house EL16-2324-1

Elementhaus • Maison à modules • Casetta in elementi • Cobertizo • Redskapsbod • Element huis • Elementti
piharakennus • Friggebod • Elementmaja

Width 233 x Depth 239 cm









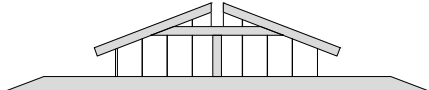
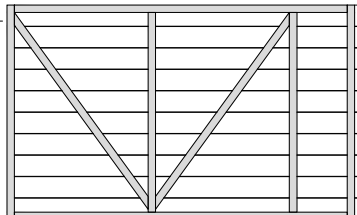
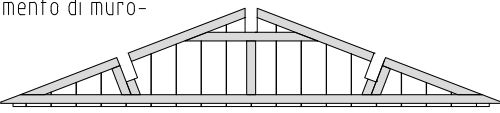
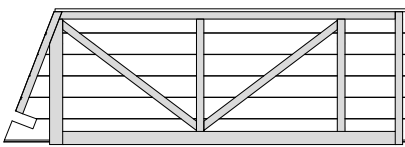
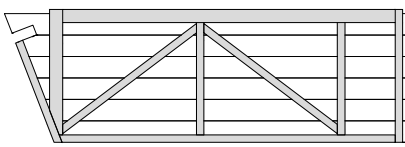

Breite/Tiefe • Largeur/Profondeur • Lunghezza/Profondità • Ancho/Profundidad • Bredd/Dybde • Breedte/Diepte •
Leveys/Pituus • Bredd/Längd • Laidus/pikkus

Log thickness 16 mm

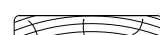

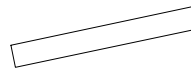

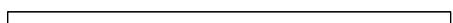
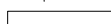

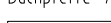

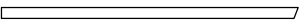
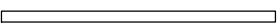

Bohlenstärke • Épaisseur des murs • Spessore delle pareti • Grosor de pared • Tykkelse • Wanddicke •
Seinän paksuus • Väggtjocklek • Seinapaksus



The producer shall have the right to make technical changes to the product • Technische Änderungen vorbehalten • Le
producteur réserve le droit d'effectuer des modifications techniques au produit • Il produttore mantiene il diritto di apportare
modifiche tecniche al prodotto • Reservado el derecho a modificaciones técnicas • Produsent forbeholder seg retten til å endre
tekniske egenskaper ved produktet • Alle rechten en technische wijzigingen voorbehouden • Valmistaja pidättää oikeuden tehdä
tuotteeseen teknisiä muutoksia • Tillverkaren har rätt att utföra tekniska förändringar för produkten • Tootja jätab endale õiguse
muuta toote tehnilisi omadusi

Pos	SPECIFICATION-STÜCKLISTE-NOMENCLATURE-ELEMENTI-ESPECIFICACIÓN EL16-2324-1	Pcs	Profile (mm)	Length (mm)
Wel-1	Wall element- Wandelement- Panneau du mur- Elemento di muro- Elemento pared 	1	48x408	1959
Wel-2	Wall element- Wandelement- Panneau du mur- Elemento di muro- Elemento pared 	6	48x1150	1884
Wel-3	Wall element- Wandelement- Panneau du mur- Elemento di muro- Elemento pared 	1	48x452	2300
Wel-4	Wall element- Wandelement- Panneau du mur- Elemento di muro- Elemento pared 	1	48x712	2155
Wel-5	Wall element- Wandelement- Panneau du mur- Elemento di muro- Elemento pared 	1	48x712	2155
AR1	Foundation- Fundament- Fondation- Fondazione- Vigas de cimentación 	6	32x40	2300
FB1-1	Floor board- Fussbodenbrett- Madrier du plancher - Tavola pavimento- Tabla de suelo 	28	89x16	2364
RB1-1	Roof board- Dachbrett- Madrier du toit- Tavola tetto- Tabla de tejado 	64	89x16	1470
EaE1-1	Eave edging- Dachrandbrett- Madrier en bordure du toit- Tavola bordo tetto- Tabla de valadizo 	4	16x95	1425
WP1	Wall panelling- Wandverkleidung- Revêtement du mur- Rivestimento di muro- Revestimiento de pared 	2	114x16	1884
FaB2-1	Facia board- Giebelblende- Écran frontal- Schermo frontone- Tabla de facia 	8	16x95	1505
RE2-1	Roof edge reinforcement- Dachrandleiste- Baguette en bordure du toit- Rinforzo bordo tetto- Refuerzo borde tejado 	2	32x40	1800
RE2-2	Roof edge reinforcement- Dachrandleiste- Baguette en bordure du toit- Rinforzo bordo tetto- Refuerzo borde tejado 	2	32x40	1050
PR1	Purlin- Dachpfette- Arbalétrier- Arcareccio- Correa  ∅	2	28x120	2400
PR2	Purlin- Dachpfette- Arbalétrier- Arcareccio- Correa  ∅	2	28x120	450
PR3	Purlin- Dachpfette- Arbalétrier- Arcareccio- Correa  ∅	4	28x120	2400
PR4	Purlin- Dachpfette- Arbalétrier- Arcareccio- Correa  ∅	4	28x120	450

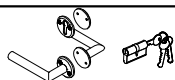
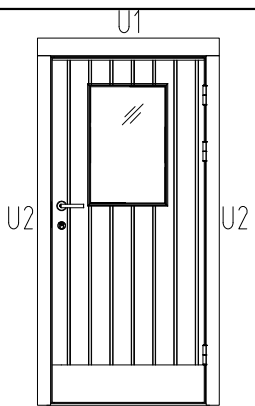
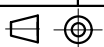

Pos	SPECIFICATION-STÜCKLISTE-NOMENCLATURE-ELEMENTI-ESPECIFICACIÓN EL16-2324-1	Pcs	Profile (mm)	Length (mm)
PR5	PurLin- Dachpfette- Arbalétrier- Arcareccio- Correa 	4	28x120	1425
CoB2	Covering board- Deckbrett- Madrier de couverture- Tavola di copertura- Llistón de cubierta 	4	70x19	1911
CoB1	Covering board- Deckbrett- Madrier de couverture- Tavola di copertura- Llistón de cubierta 	4	70x19	1764
WB1-1	Wind brace- Windbrett- Madrier contre le vent- Tavola vento- Tabla contra el viento 	4	16x45	1505
Fim	-Fixing kit- Befestigungsset- Moyens de fixation- Materiale di fissaggio- Kit de fijación	1		
QNU40x40x40Zn	L-iron- Winkel- Angle -Angolo- Angulo 40x40x40 	6		
QNA2 2x50Zn	Nail- Nagel- Clou- Chiodo- Clavo- 2.5x50mm 	370		
QKRPP3 5x40Zn	Screw- Schraube- Vis- Vite- Tornillo- 3.5x40mm 	130		
QKRPP4 5x50Zn	Screw- Schraube- Vis- Vite- Tornillo- 4.5x50mm 	180		
QKRPP4 5x70Zn	Screw- Schraube- Vis- Vite- Tornillo- 4.5x70mm 	90		
QKRYP5 x40ZnTX	Screw- Schraube- Vis- Vite- Tornillo- 5x40mm 	30		
QKRPP3 5x35Zn	Screw- Schraube- Vis- Vite- Tornillo- 3.5x35mm 	120		
QKRPP 5x90Zn	Screw- Schraube- Vis- Vite- Tornillo- 5x90mm 	14		
QKRPP 6x120Zn	Screw- Schraube- Vis- Vite- Tornillo- 6x120mm 	4		
QLIUY QULKAY-1 QULSI35x35-1		1		
	 U90-21-919P 870x1885x90 U1-19x95x1000 1pcs U2-19x70x1900 2pcs	1		
	Object name EL16-2324-1		Page	1/1

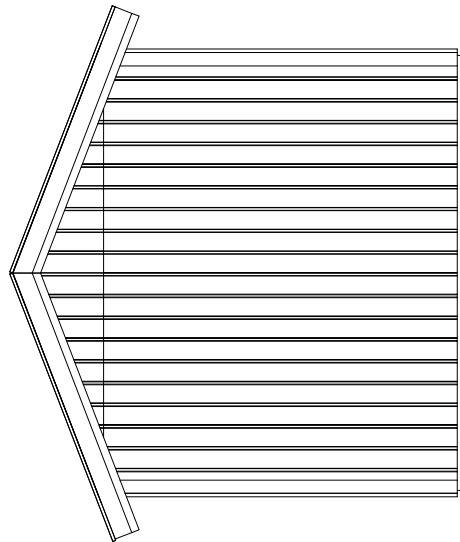
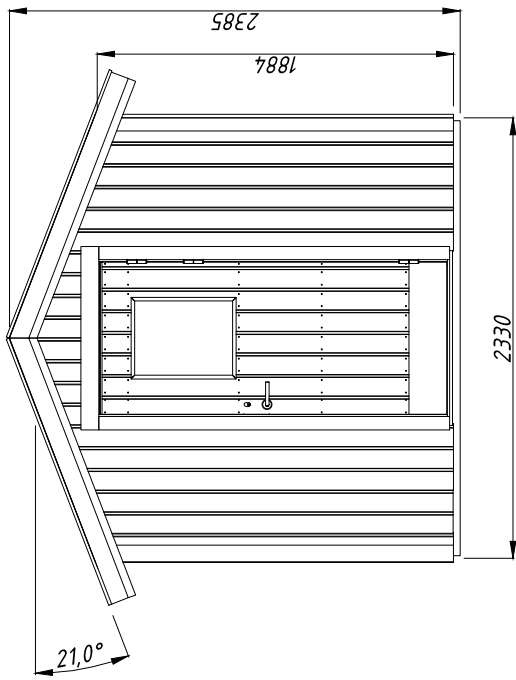
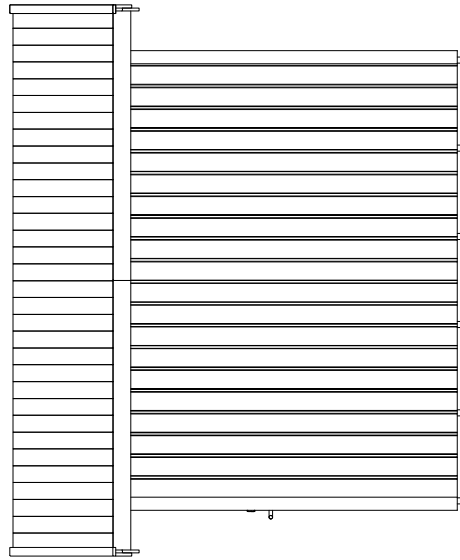
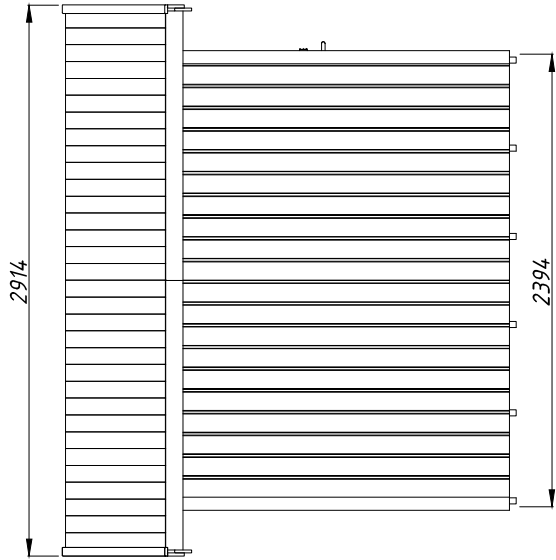

Object name	Drawing		Lucas 5.4	1:40
	Customer	Log		Paper A4
AS Palmako Naituse 25, Tartu 50409, Estonia tel. +372 73 55 530 fax. +372 73 55 544 www.palmako.com	Drawn by	862		
	Date	25.07.2019		Page 1

Palmako
LEMEIS GROUP

AR1

6 pcs

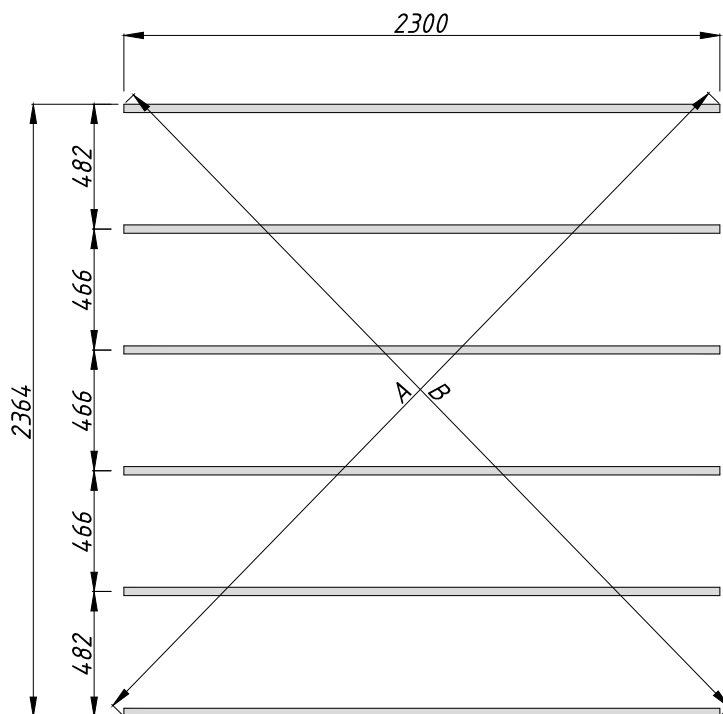
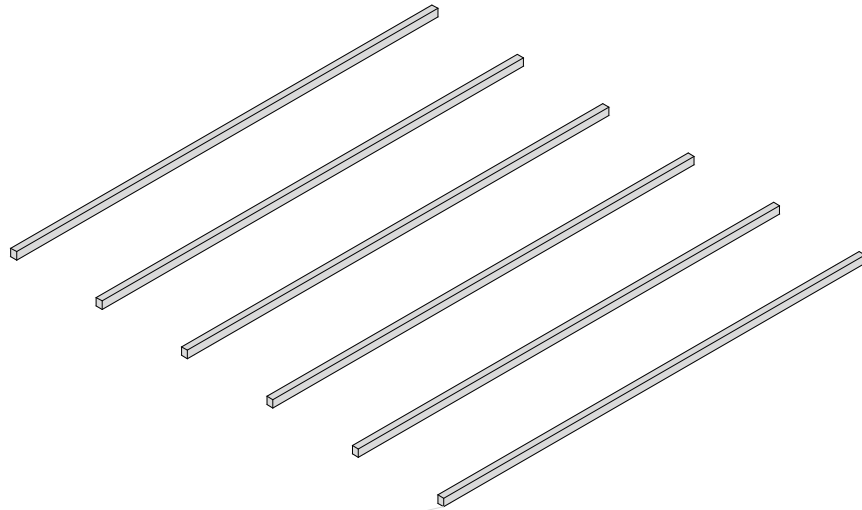
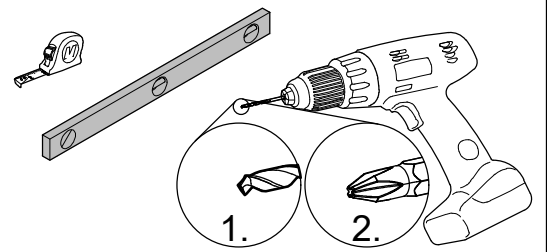

FB1-1 28 pcs
2,5x50 170 pcs

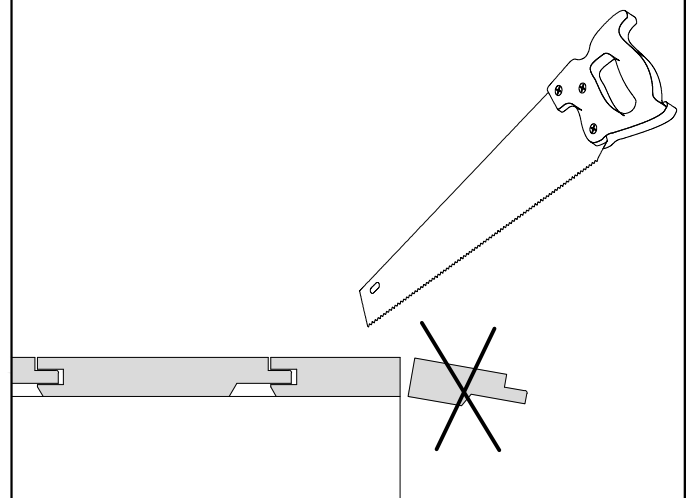
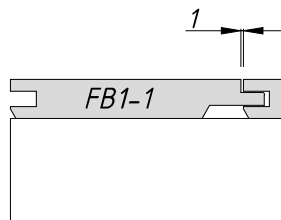
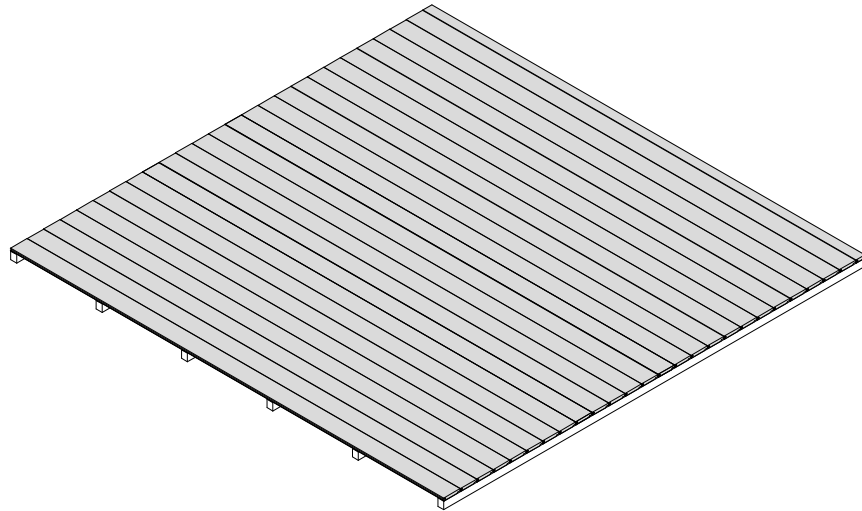
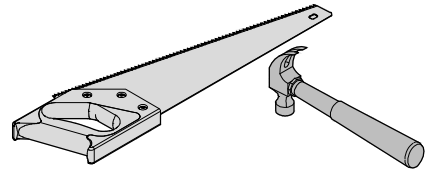

Wel-2 6 pcs
4,5x70 42 pcs

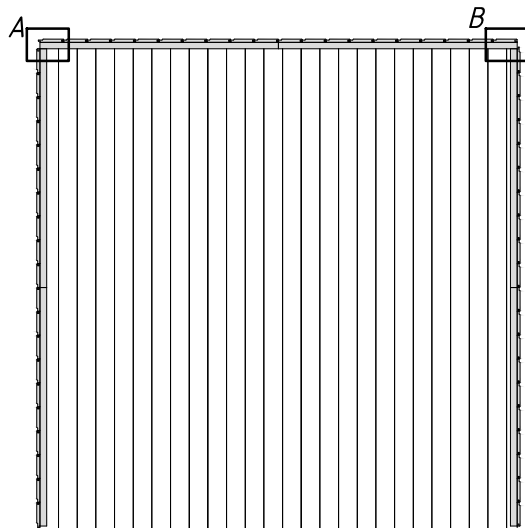
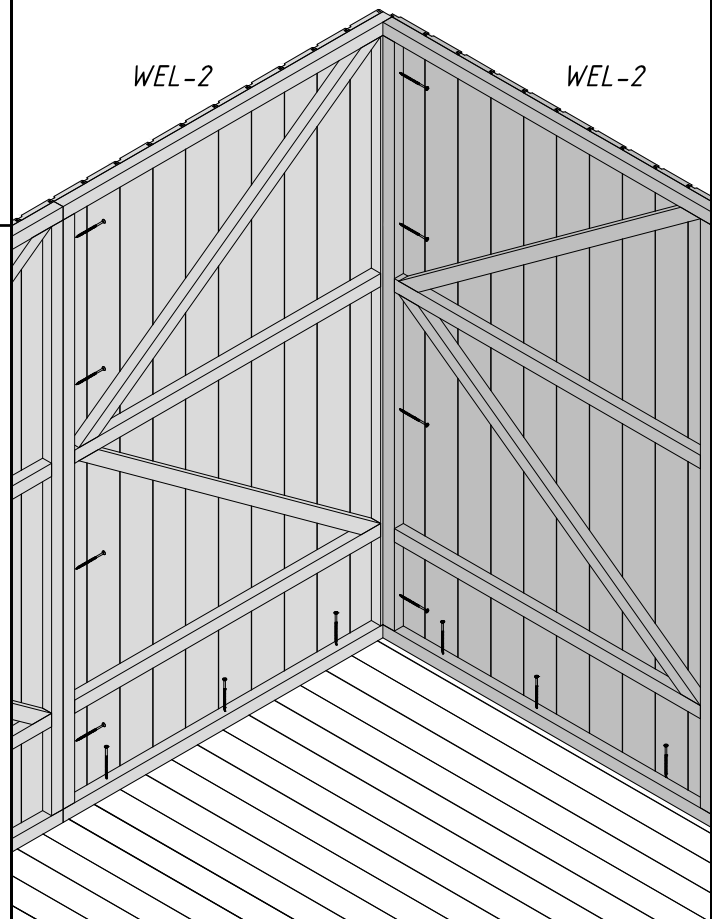
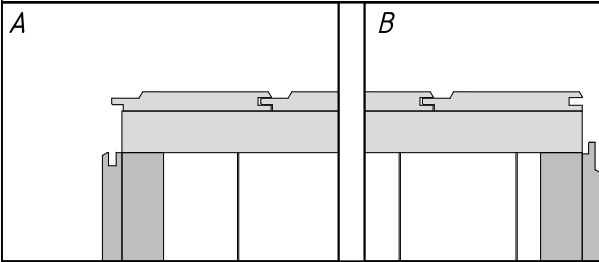
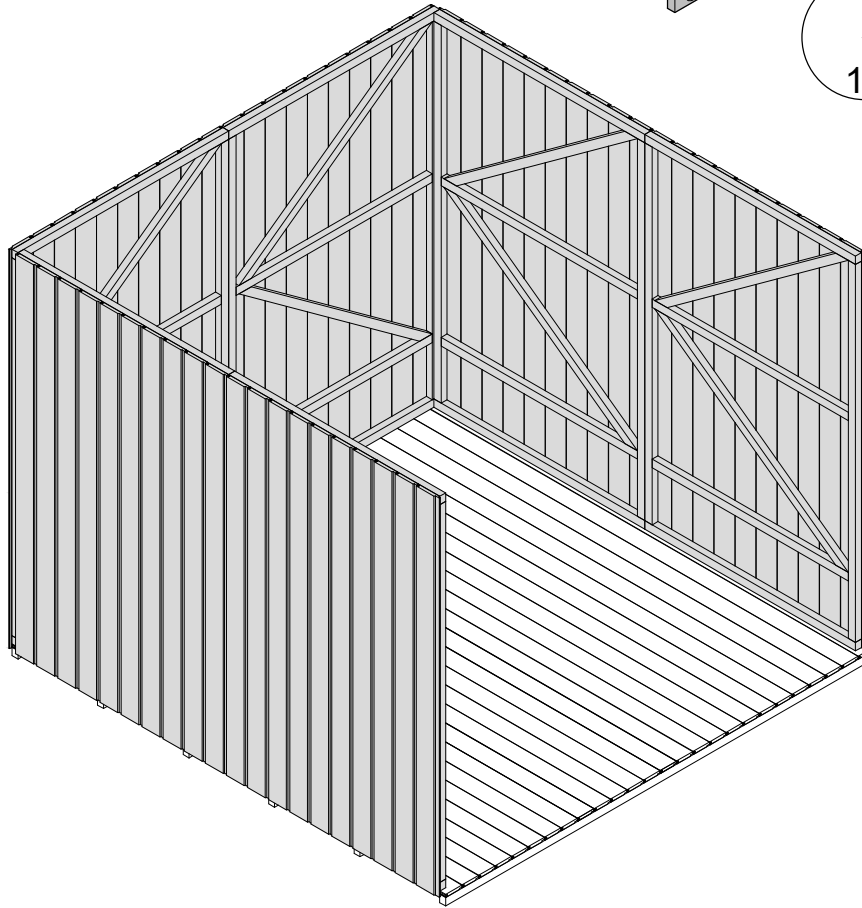
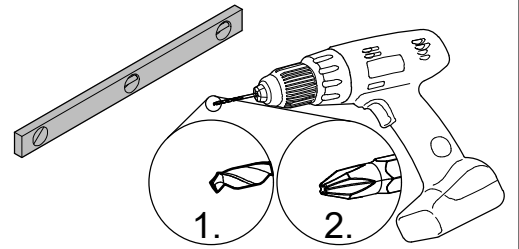
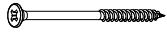

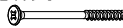
- Wel-1 1 pcs
- Wel-4 1 pcs
- Wel-5 1 pcs
- 3.5x40 4 pcs
-  5x90 2 pcs
-  6x120 4 pcs

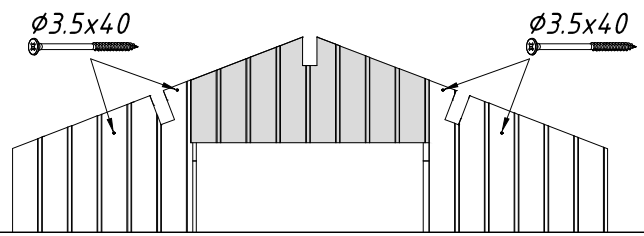
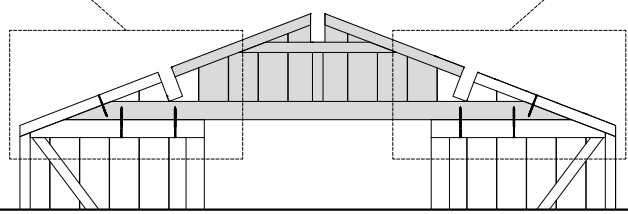
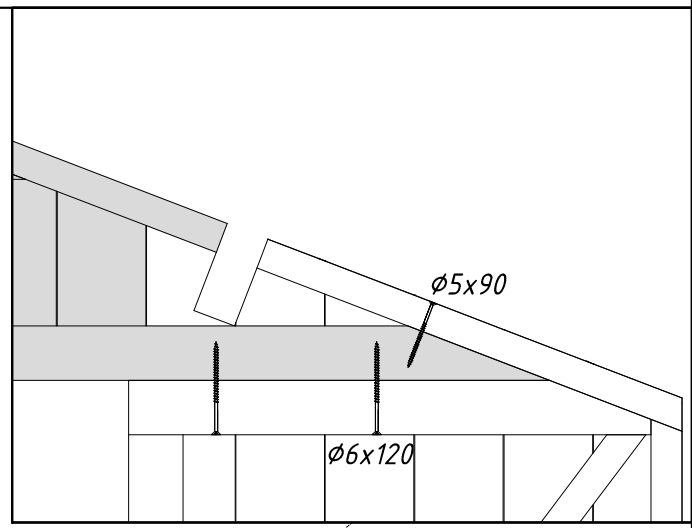
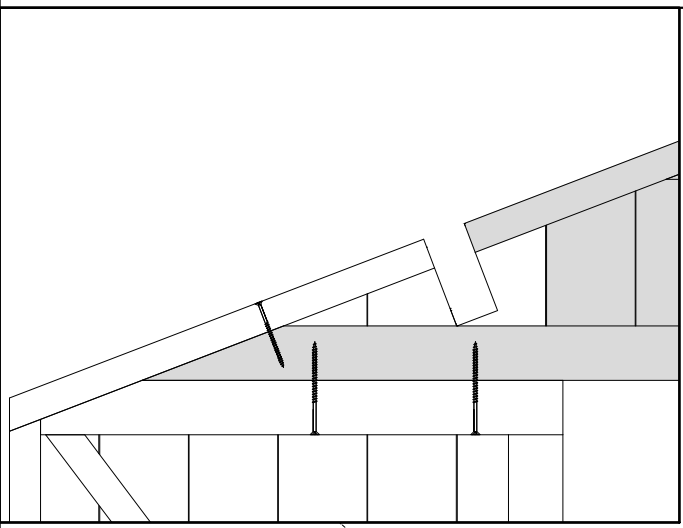
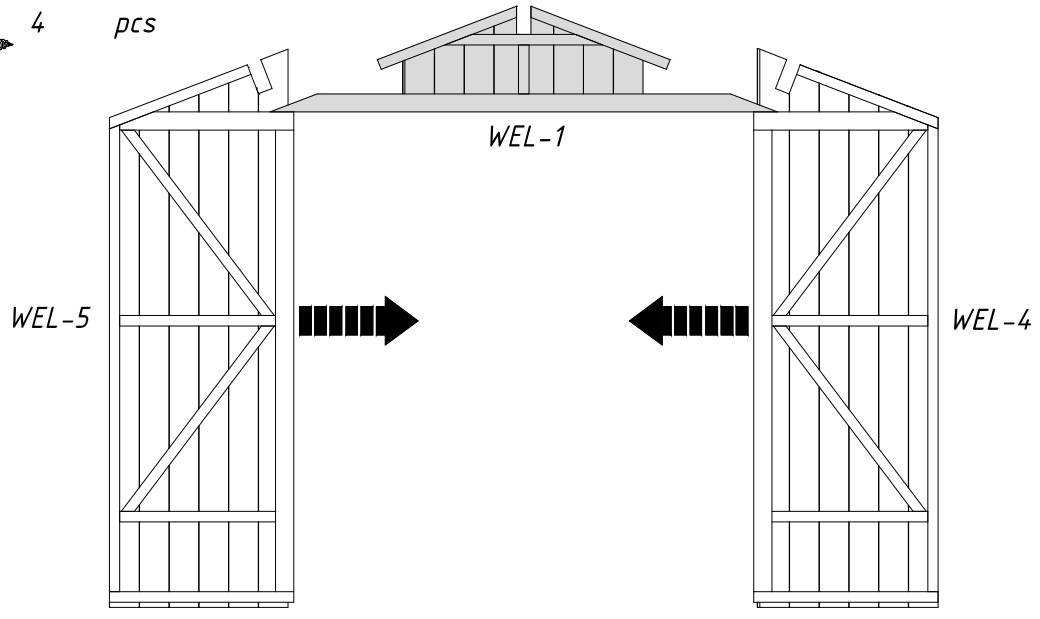
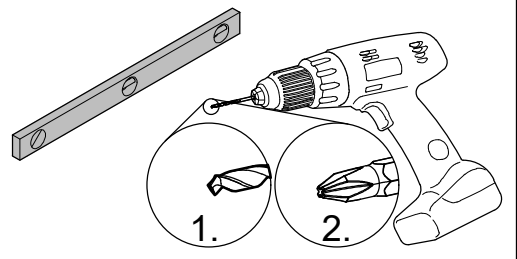



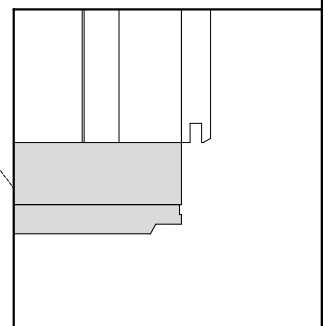
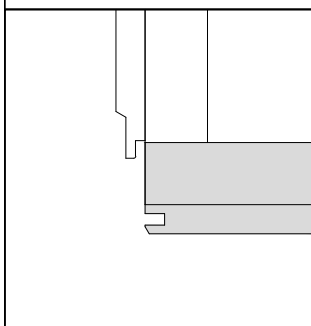
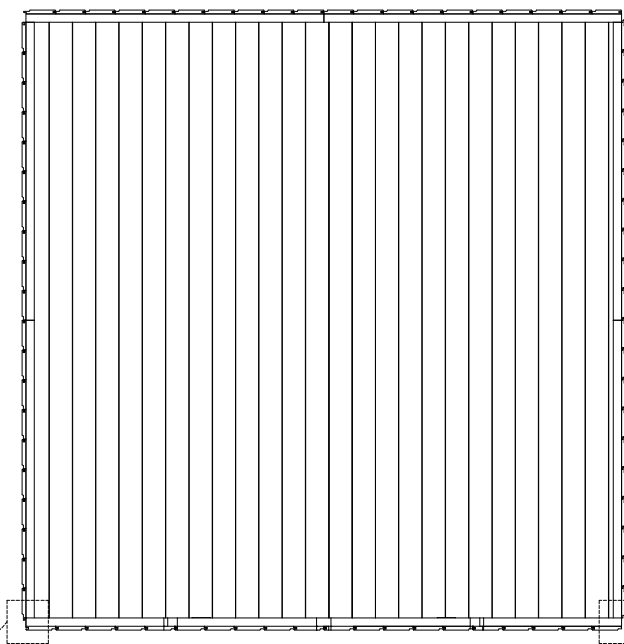
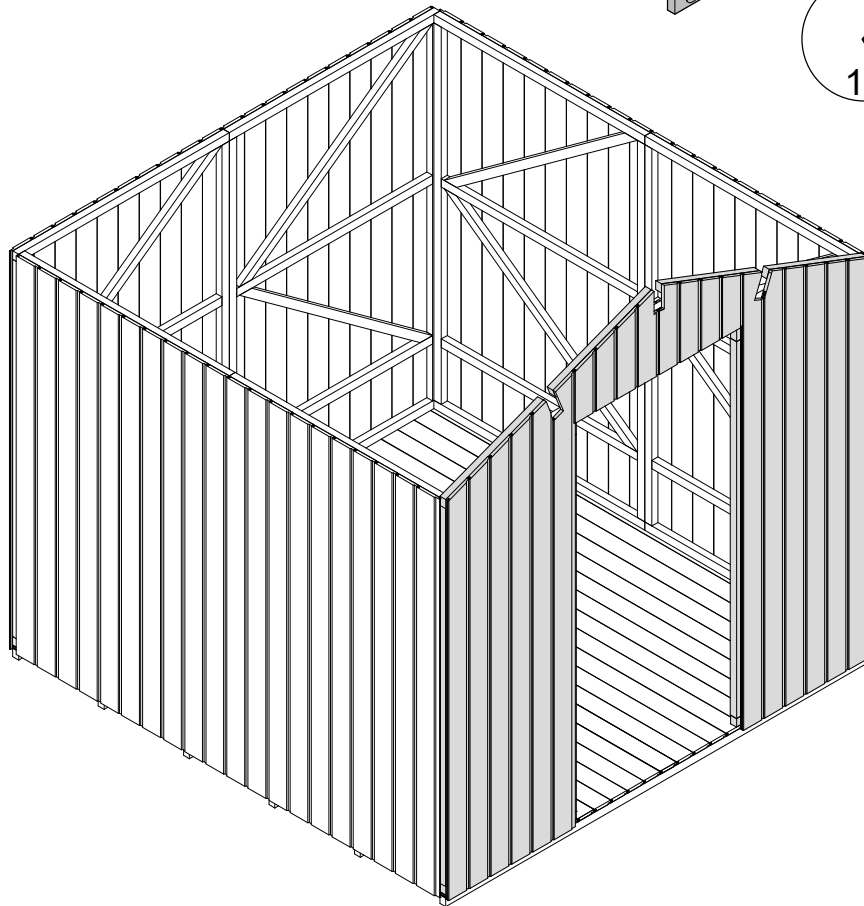
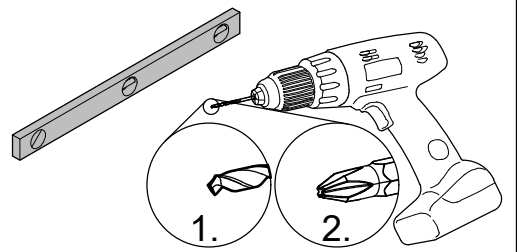

Wel-1/Wel-4/Wel-5
4.5x70 16 pcs

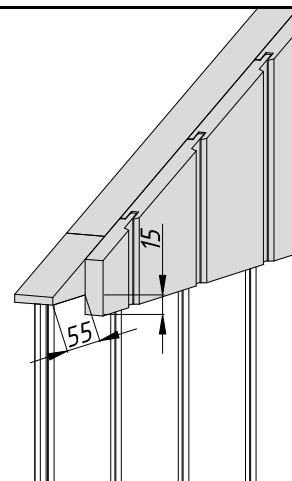
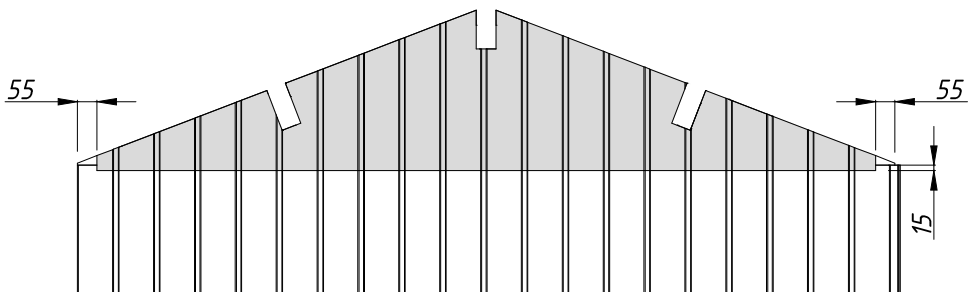
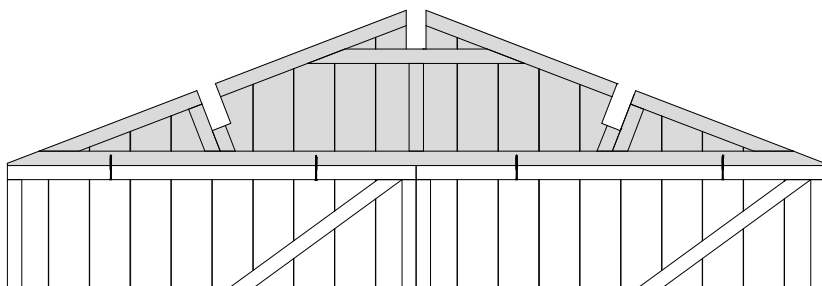
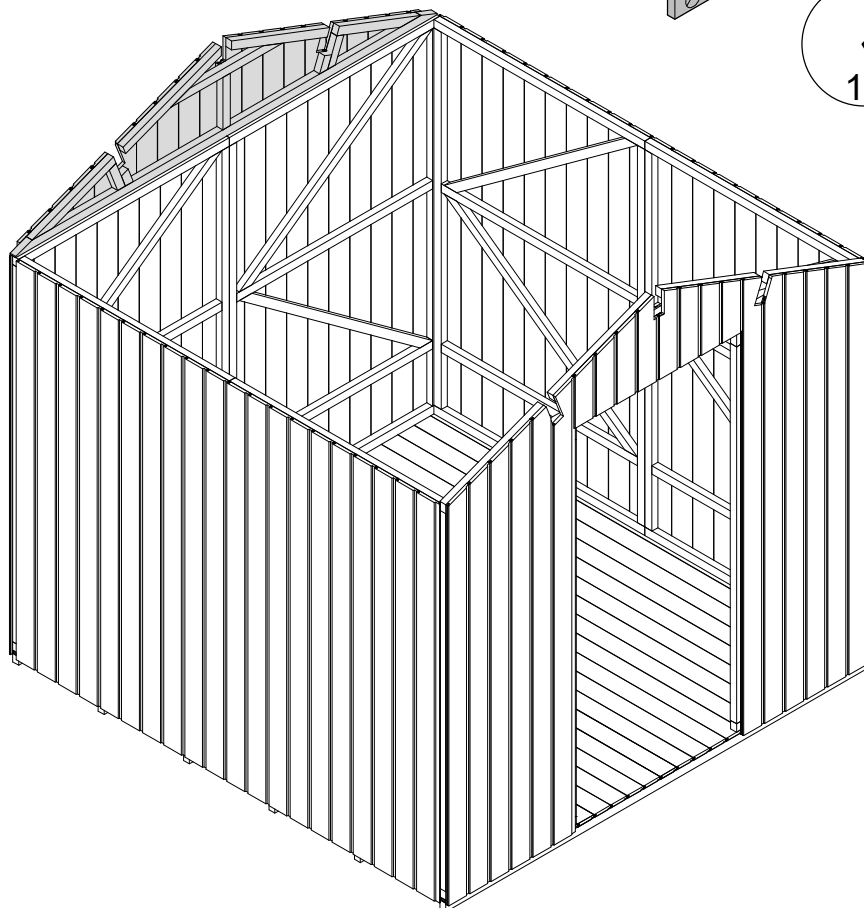
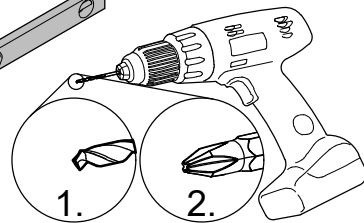
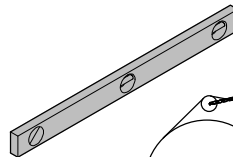
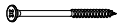

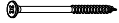
Wel-3 1 pcs
4.5x70 4 pcs



PR1+PR2	1	pcs	4.5x50		108	pcs
PR3+PR4	2	pcs				
PR5	4	pcs				
40x40x40	6	pcs				
5x40	24	pcs				
4.5x70	24	pcs				
5x90	12	pcs				

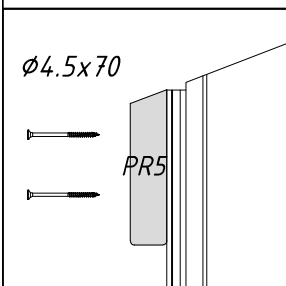
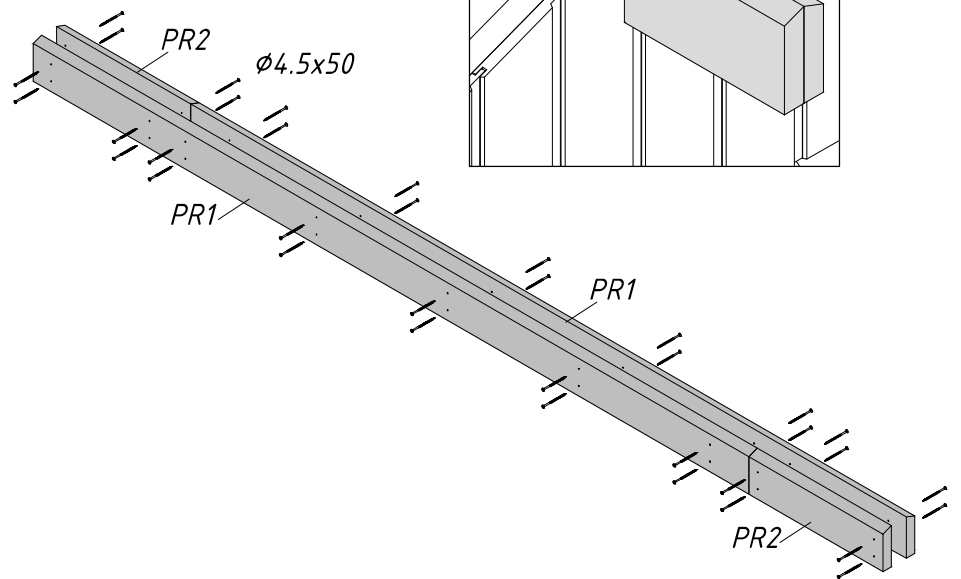
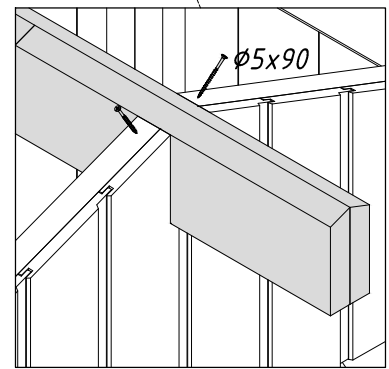
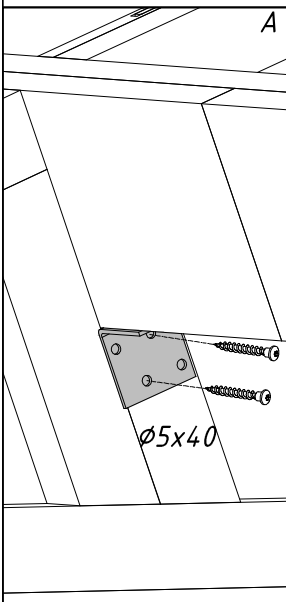
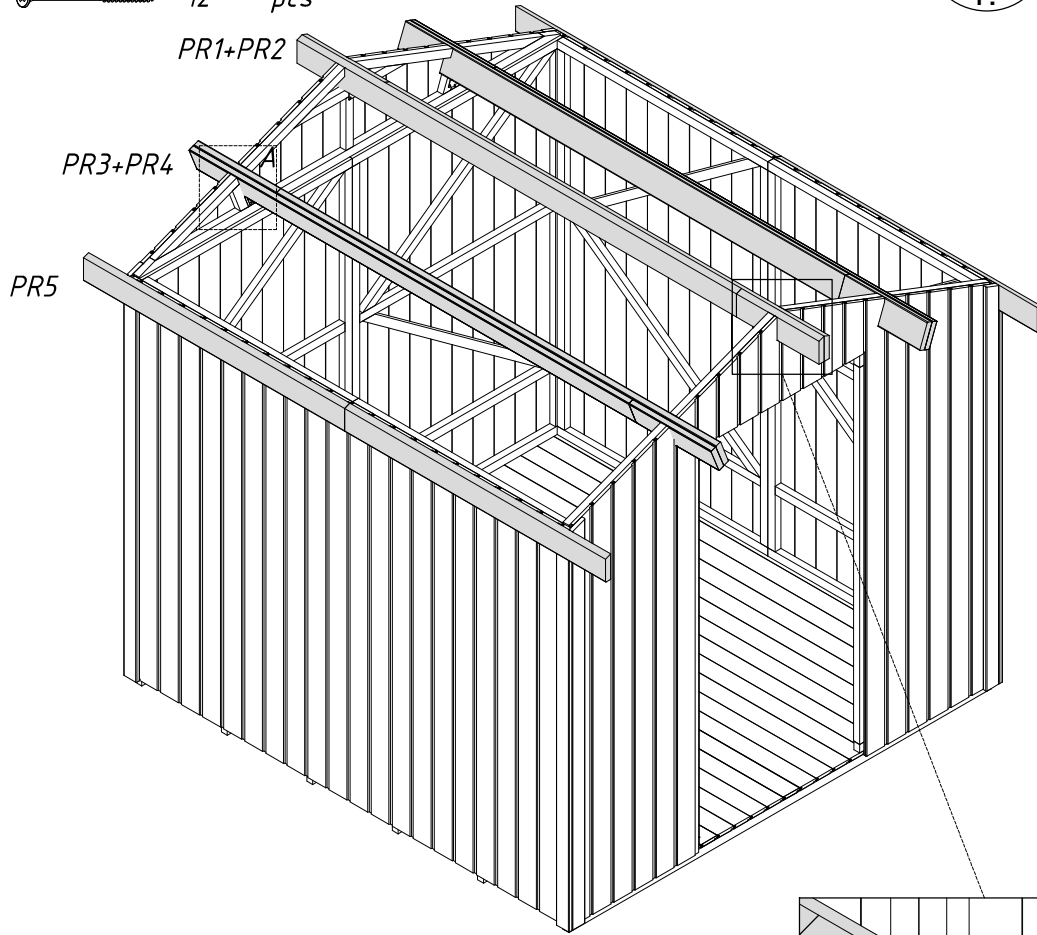
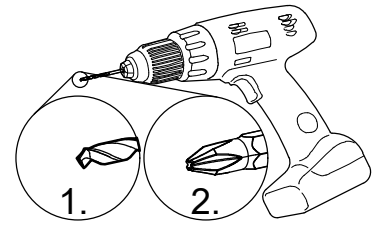

- WP1 2 pcs
- CoB1 4 pcs
- CoB2 4 pcs
- 3.5x40 20 pcs
- 4.5x50 48 pcs

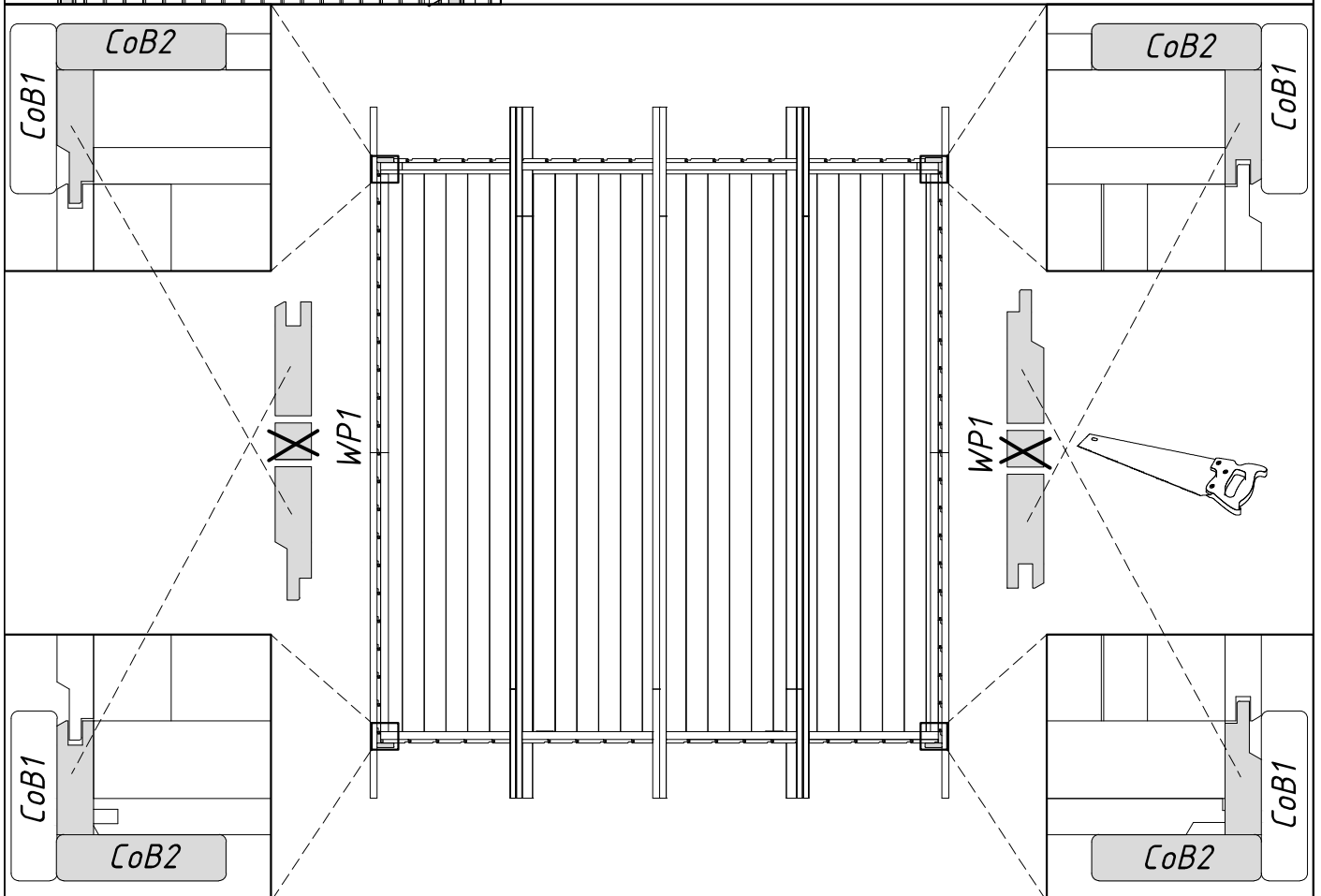
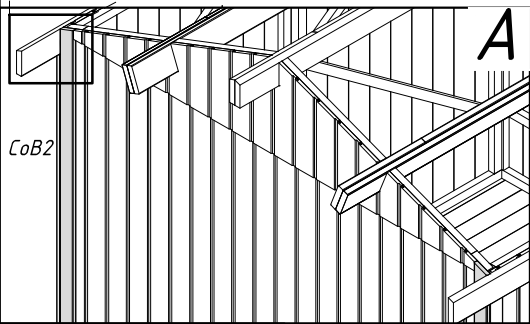
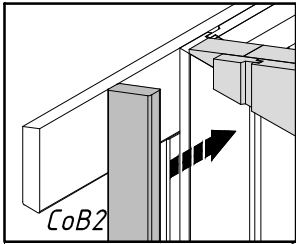
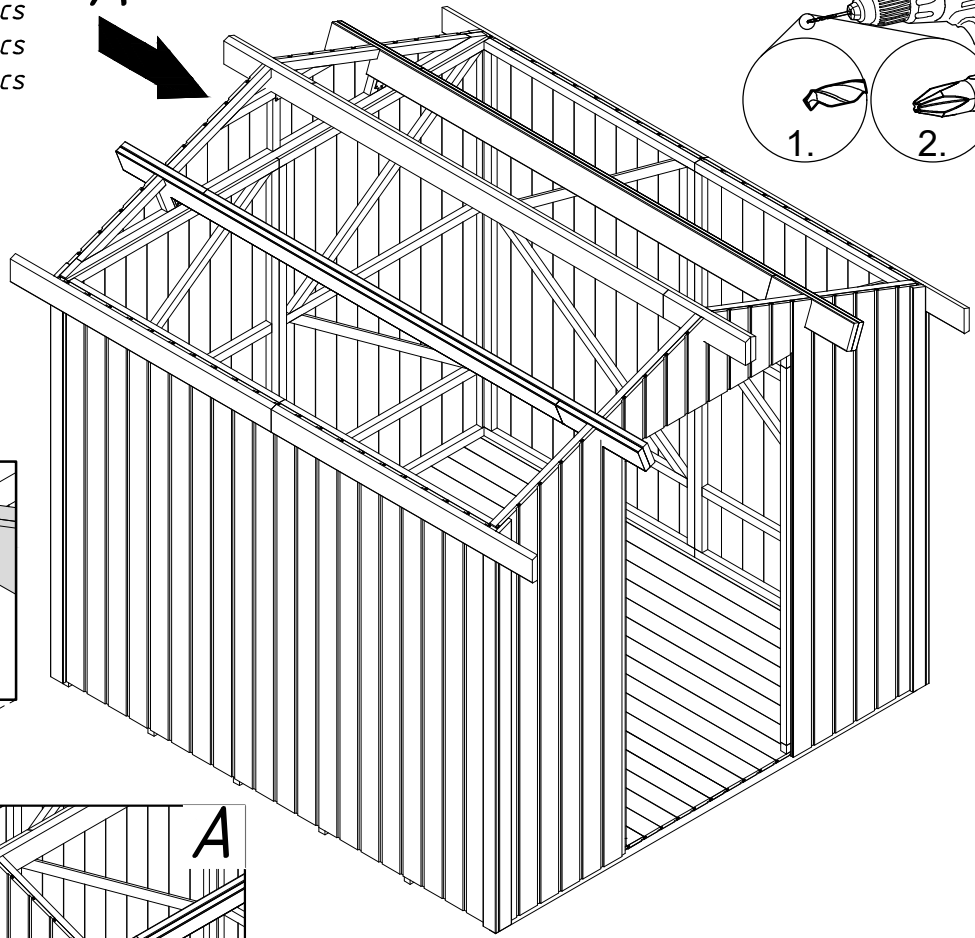
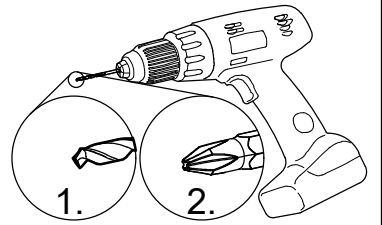

U90-21-919P

1 pcs

5x90

8 pcs

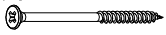

4.5x50

15 pcs

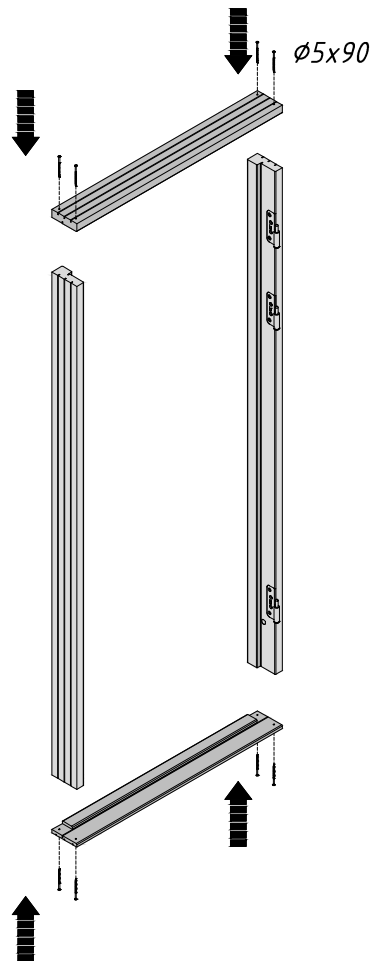
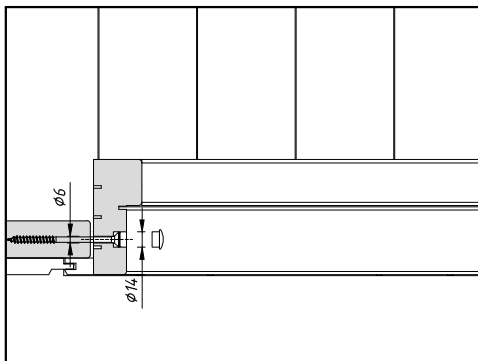
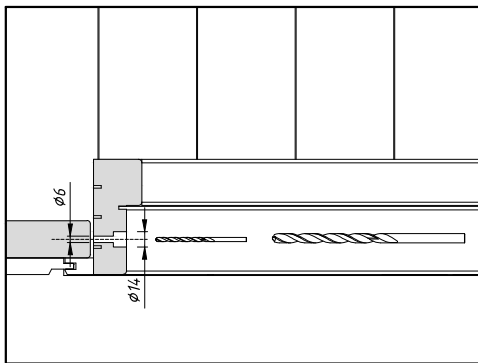
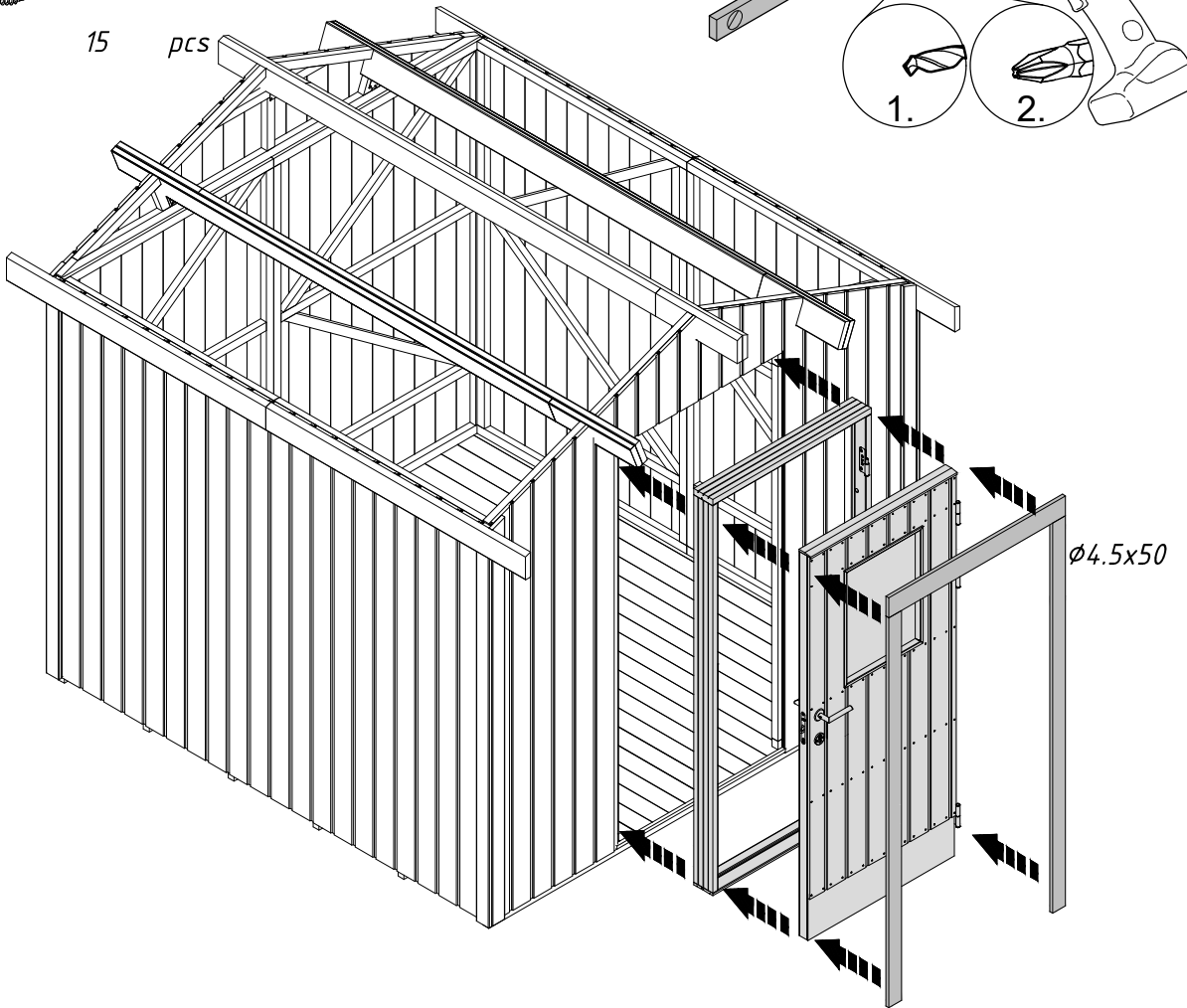
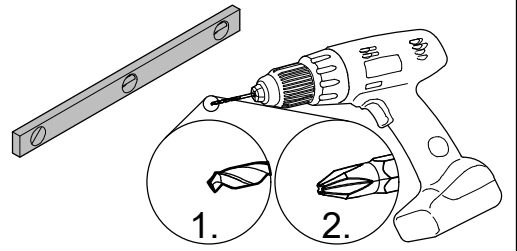
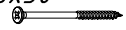

RB1-1 64 pcs
2,5x50 200 pcs

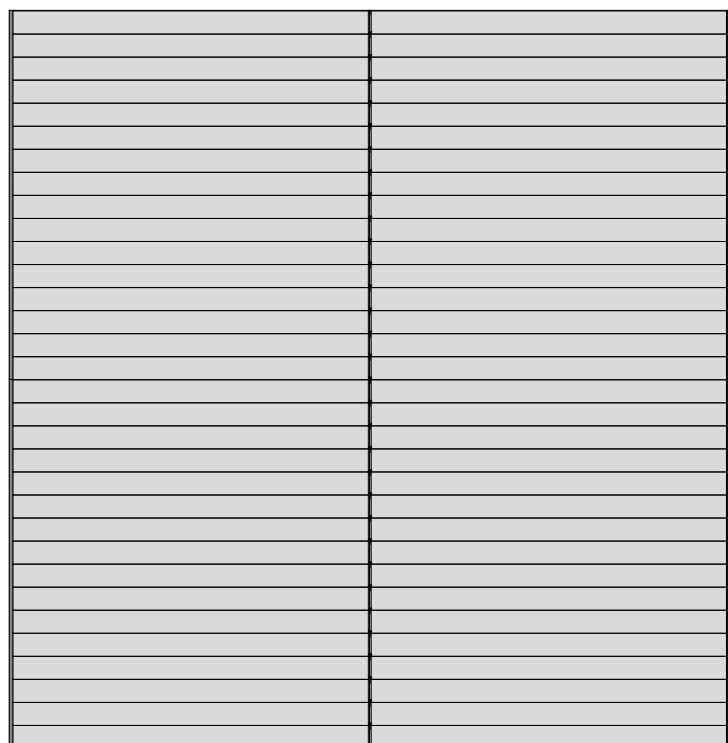
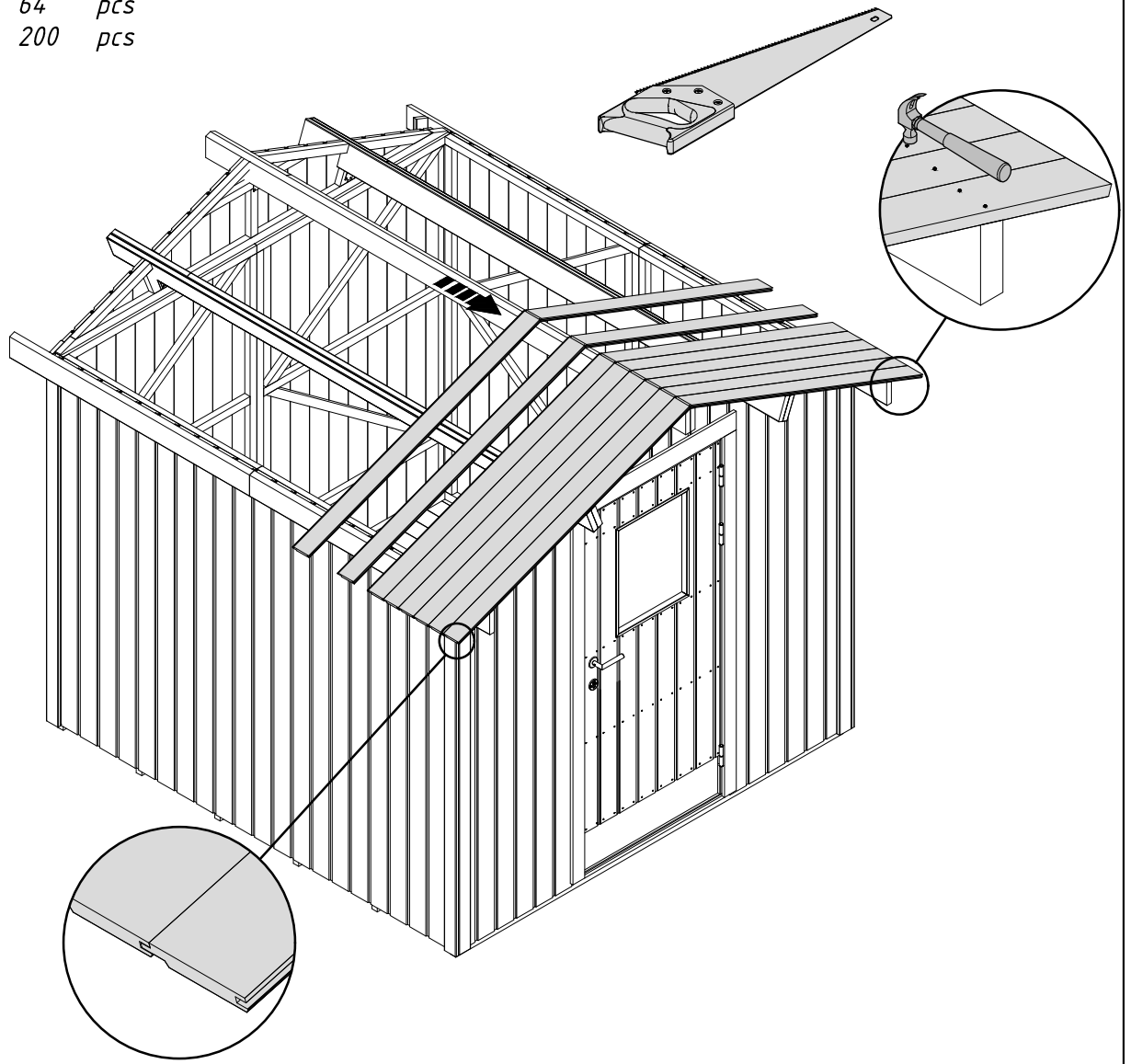

RE2-1 2 pcs
RE2-2 2 pcs
3,5x40 32 pcs

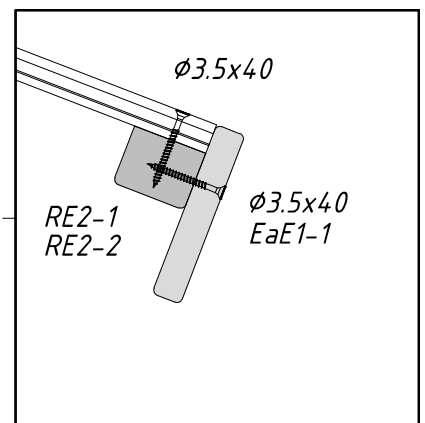
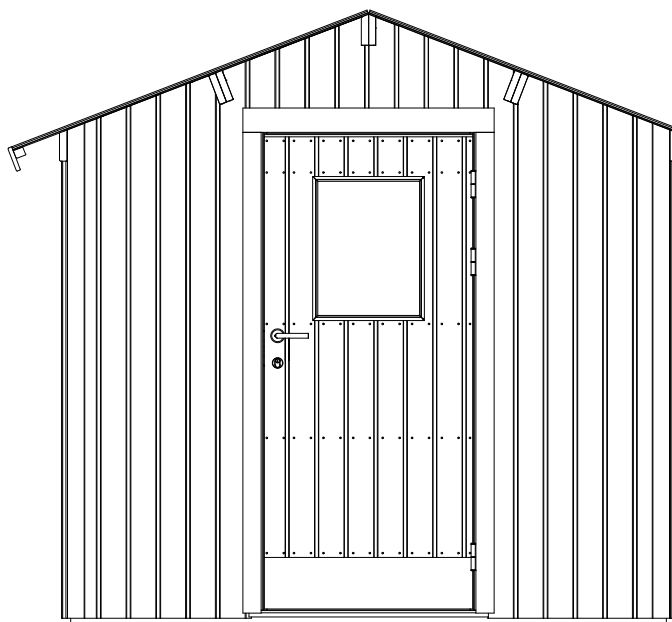
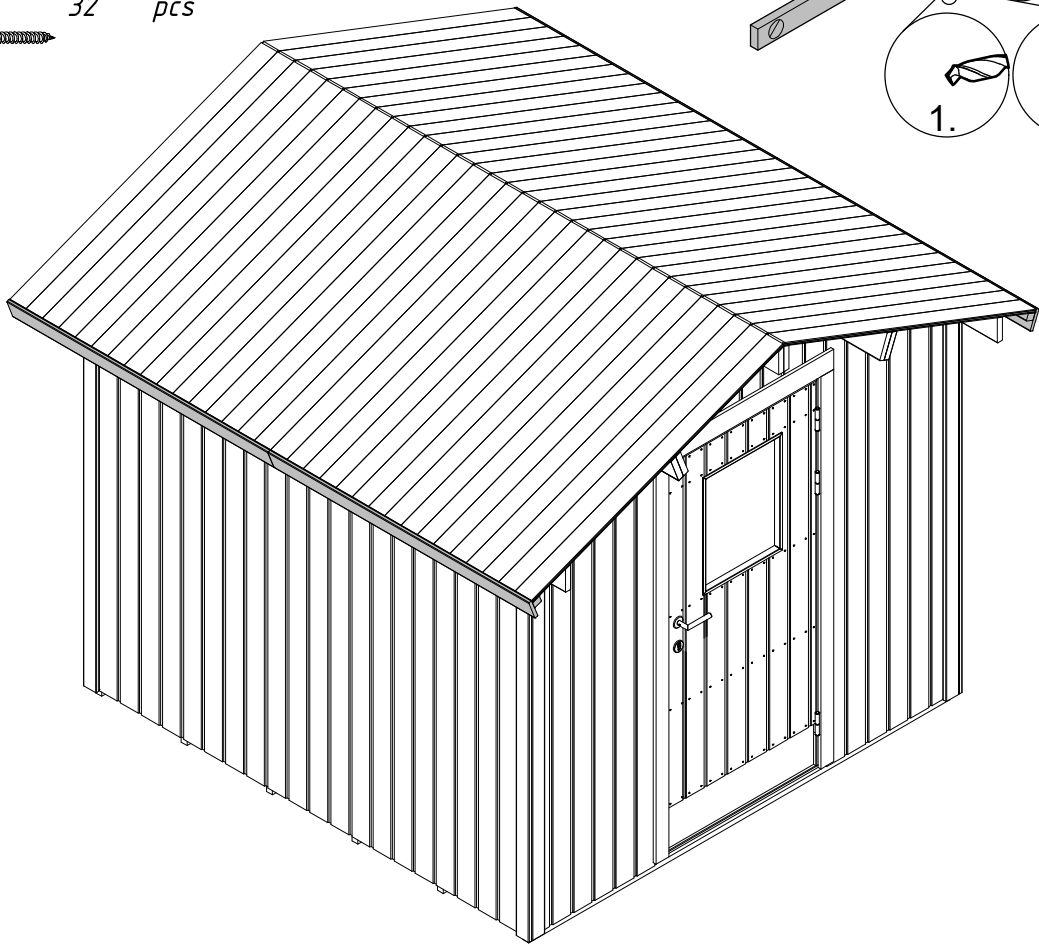
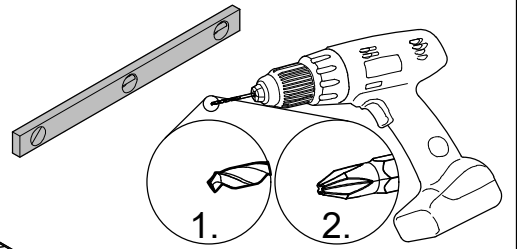

FaB2-1 8 pcs
WB1-1 4 pcs
3,5x40 64 pcs

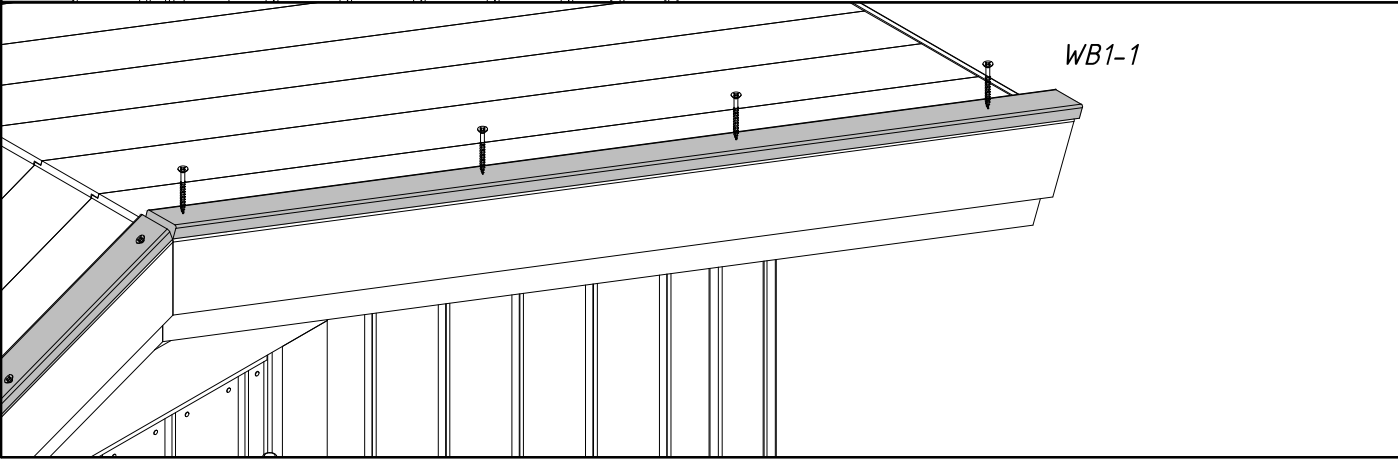
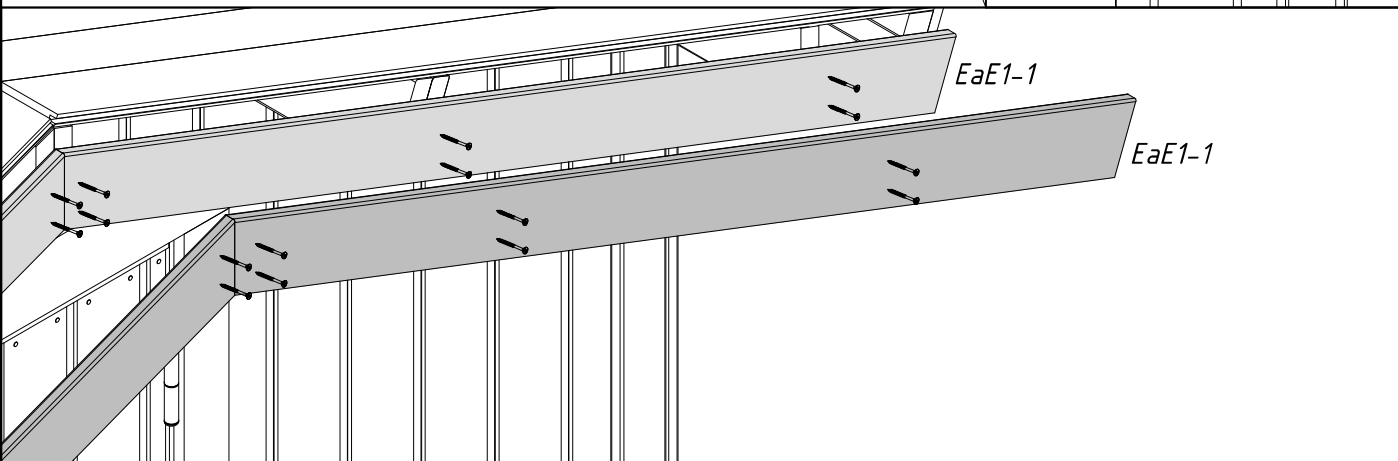
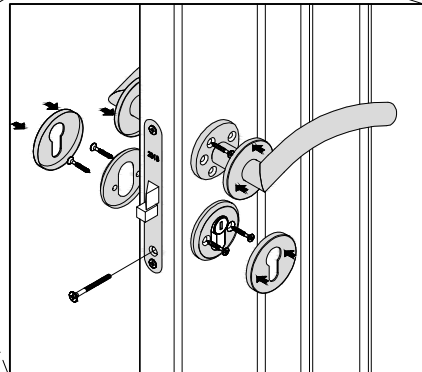
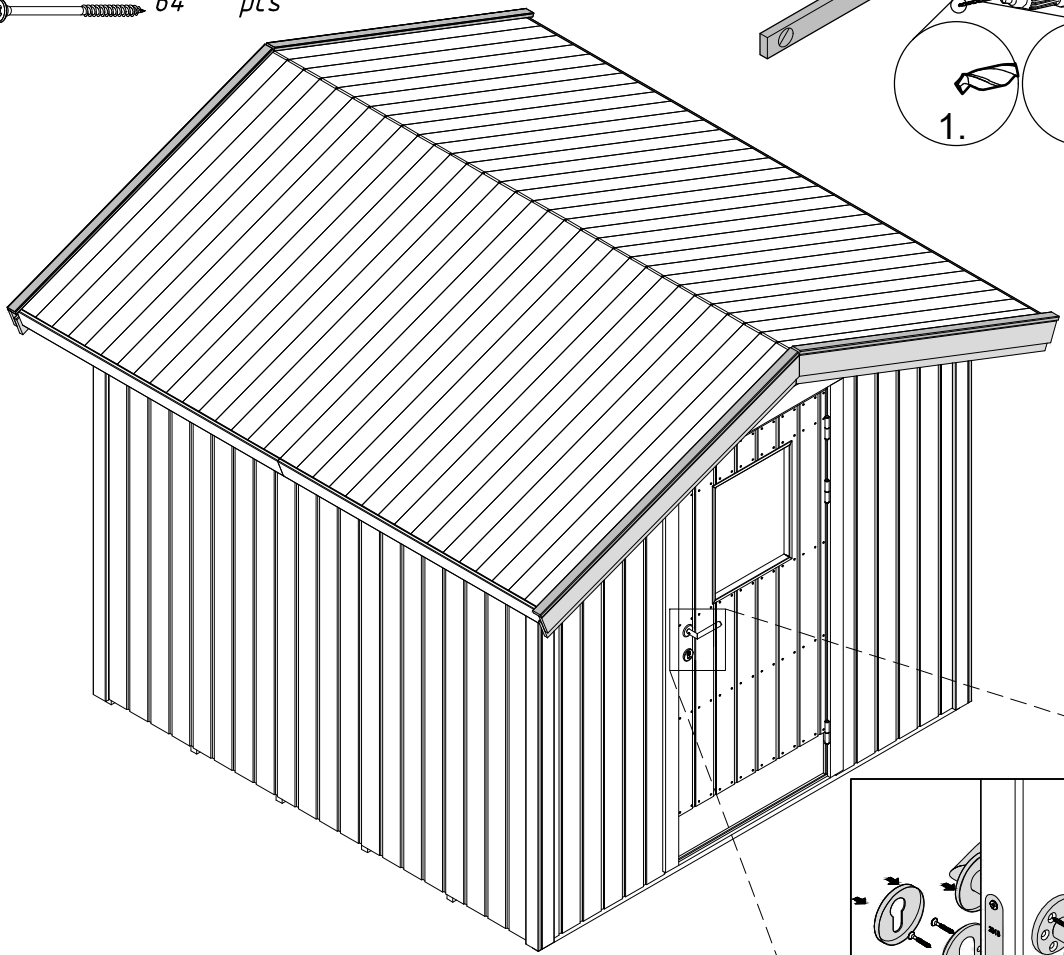
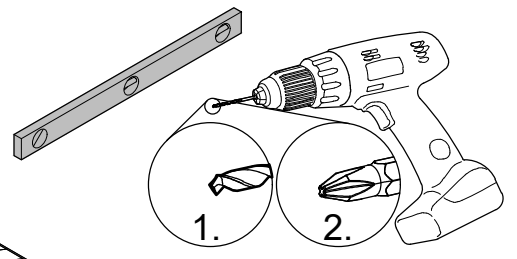



U90-21-919P

9x19

Palmako

LEMEKS GROUP

Näituse 25, 50409, Tartu, Estonia

Tel: +372 735 5530

Fax: +372 735 5544

www.palmako.ee

Palmako
LEMEKS GROUP

U90-21-919P

9x19



Note! Product that is used outdoors, needs to be painted before usage.

Notera! Produkt som används utomhus måste målas före användning.

Bemærk! Produkter, der anvendes udendørs, skal være malet før brug.

Merk! Produktet som skal brukes utendørs, må males før bruk.

Huomio! Ulkona käytettävät tuotteet täytyy värjätä ennen käyttöä.

Pane tähele! Kui toodet kasutatakse välitingimustes, tuleb seda enne kasutamist värvida.

Caps between window frame and door cladding needs to be filled with silicone before outdoors usage.

Håligheter mellan fönsterglaslist och träpanel behöver fyllas med fog innan utomhusanvändning.

Hulrum mellem vindue glas lister og paneler skal fyldes med fugemasse eller andet fyld før udendørs brug.

Hulrom mellom vindu glass listverk og trepanel må fylles med fugemasse eller annen fylling før utendørsbruk.

Välit ikkunankehysten ja oven laudoituksen välillä täytyy tasoittaa silikonilla ennen ulkokäyttöä.

Välitingimustes tuleb aknaraami ja ukse laudise vahel olevad vahed täita silikooniga.

TOOLS REQUIRED

VERKTYG SOM DU BEHÖVER

VERKTUJ, DU SKAL BRUGE

VERKTÜY SOM DU TRENGER

ASENNUKSESSA TARVITTAVAT TYÖKALUT

VAJALIKUD TÖÖRIISTAD

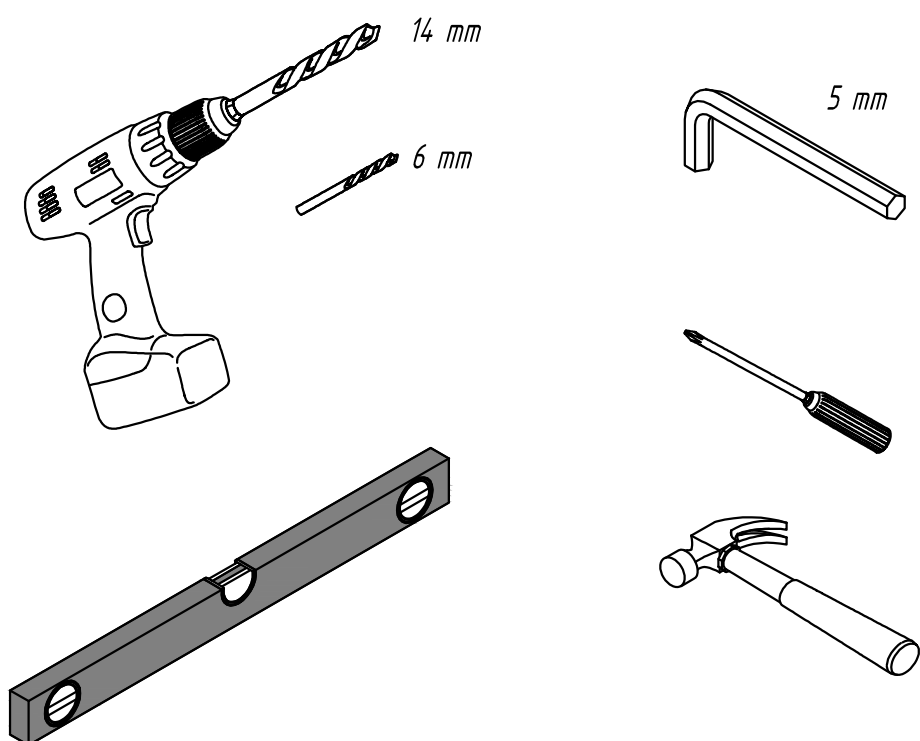

ACCESSORIES NOT INCLUDED

TILLBEHÖR SOM DU BEHÖVER

TILBEHØR, DER IKKE MEDFØLGER

TILBEHØR SOM IKKE FØLGER MED

ASENNUKSESSA TARVITTAVAT TARVIKKEET

PUUDUVAD LISAMATERJALID

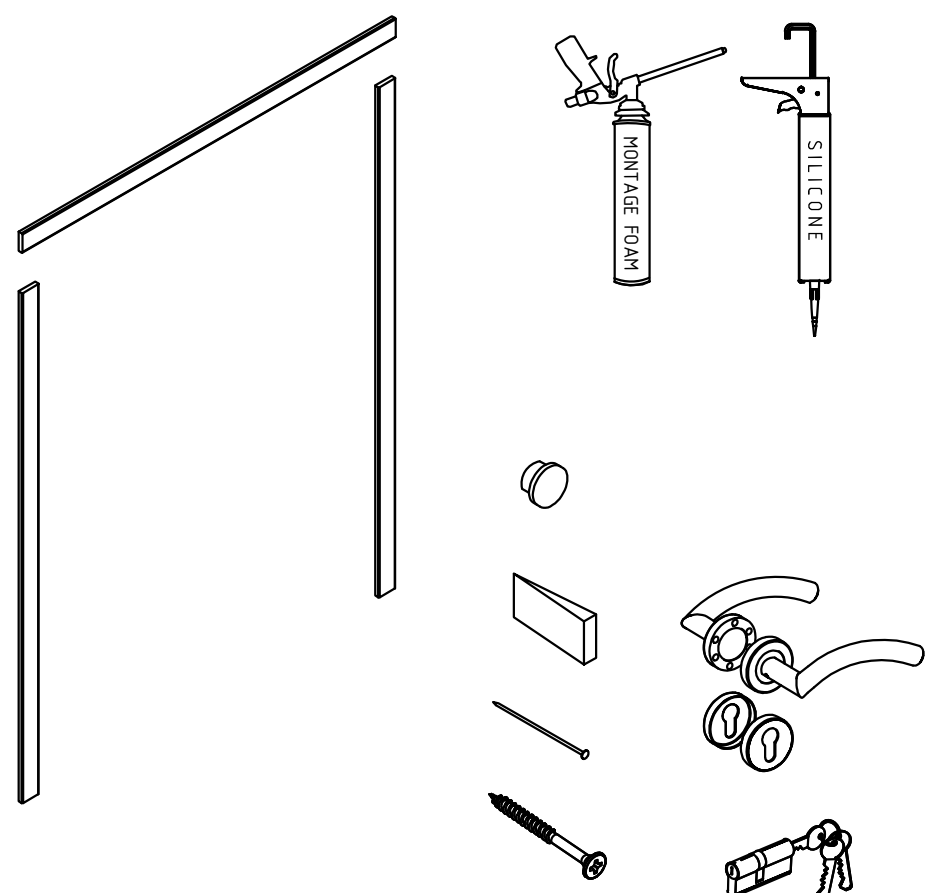

1

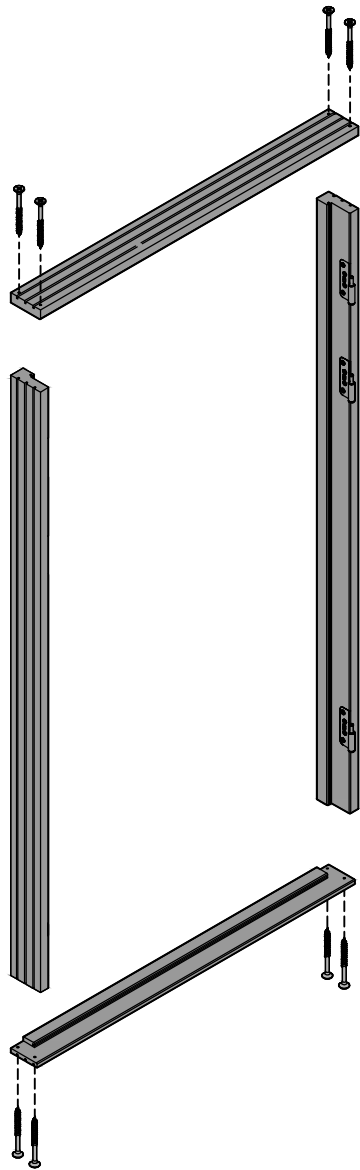

3

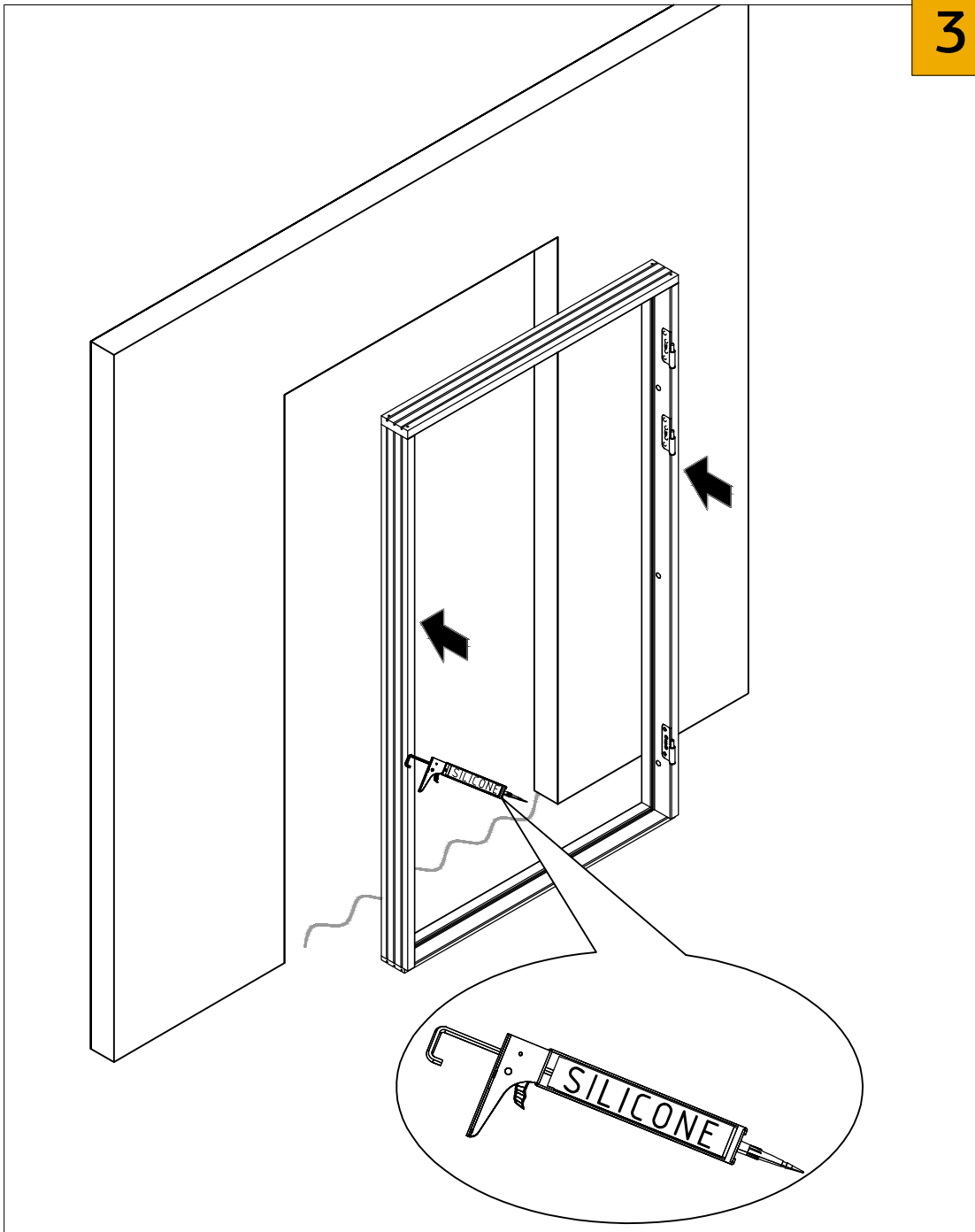

2

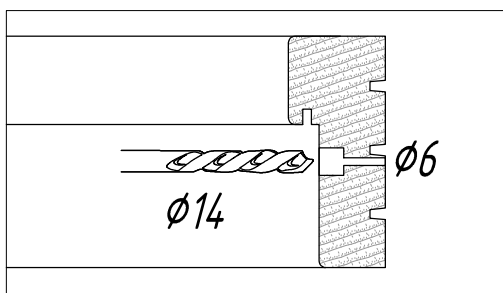
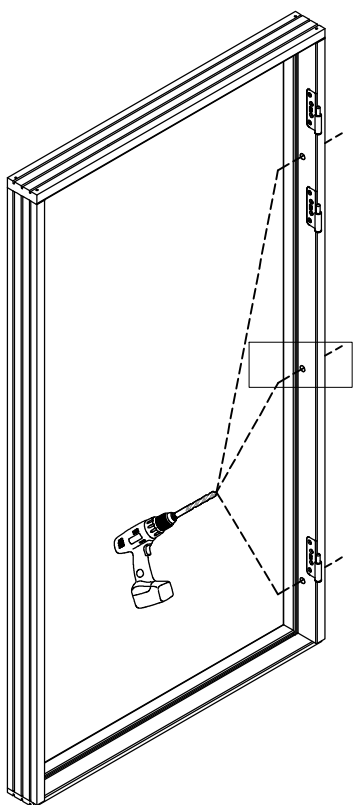

4

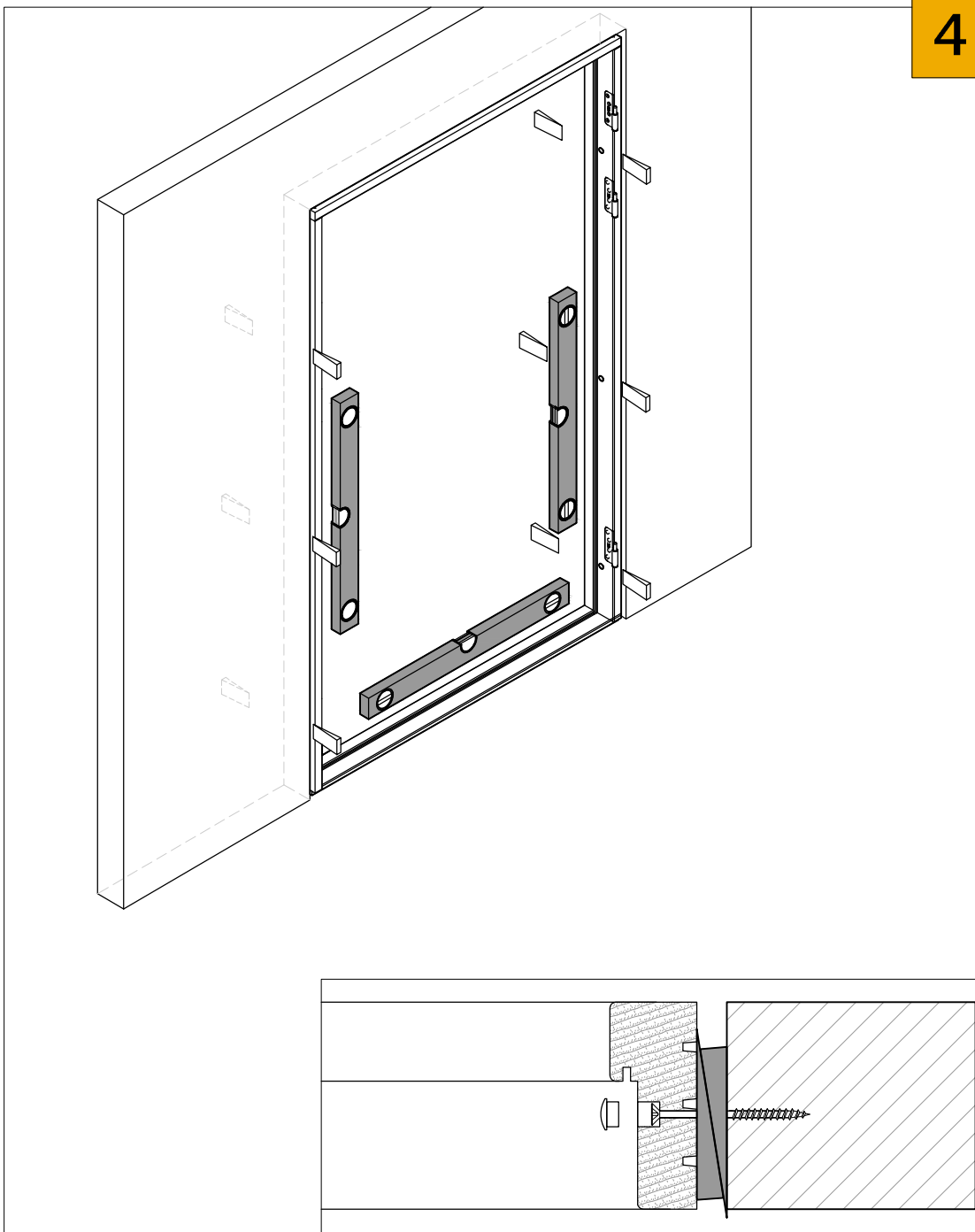

5

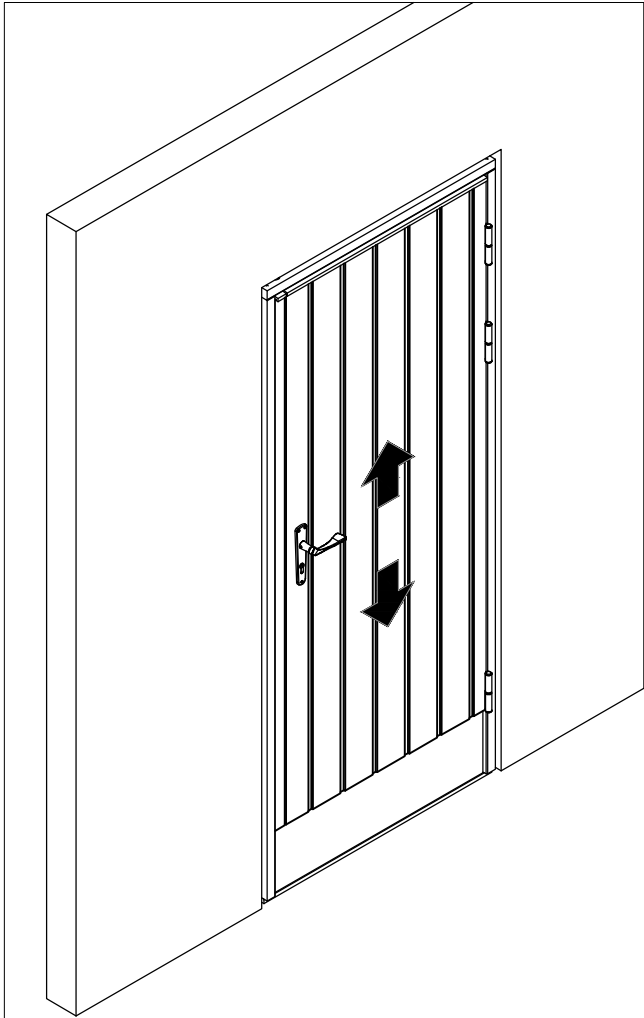

5a

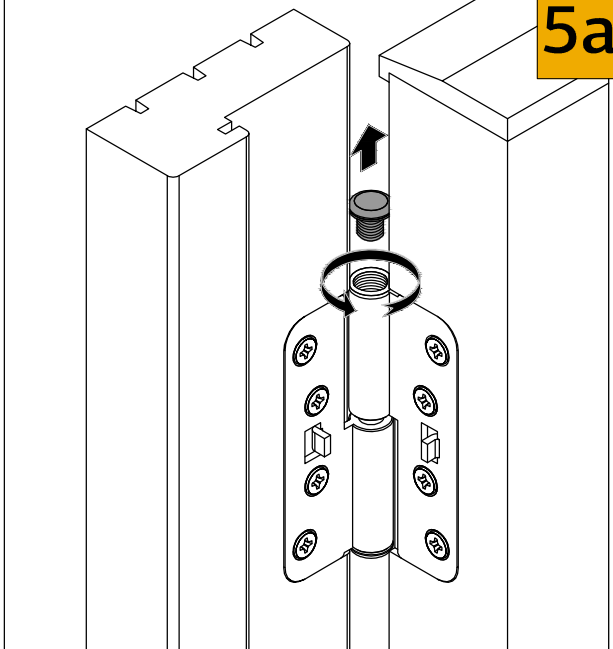

5b

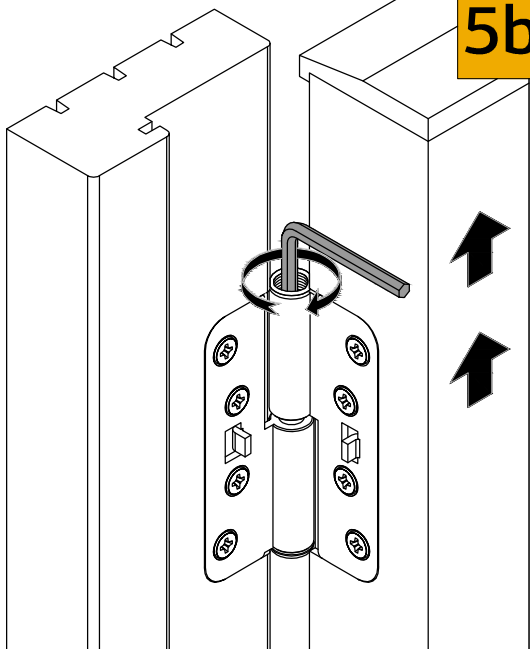

5c

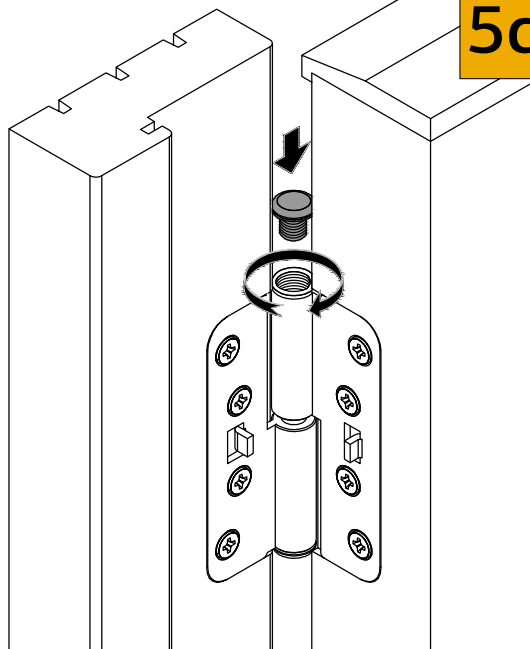

6

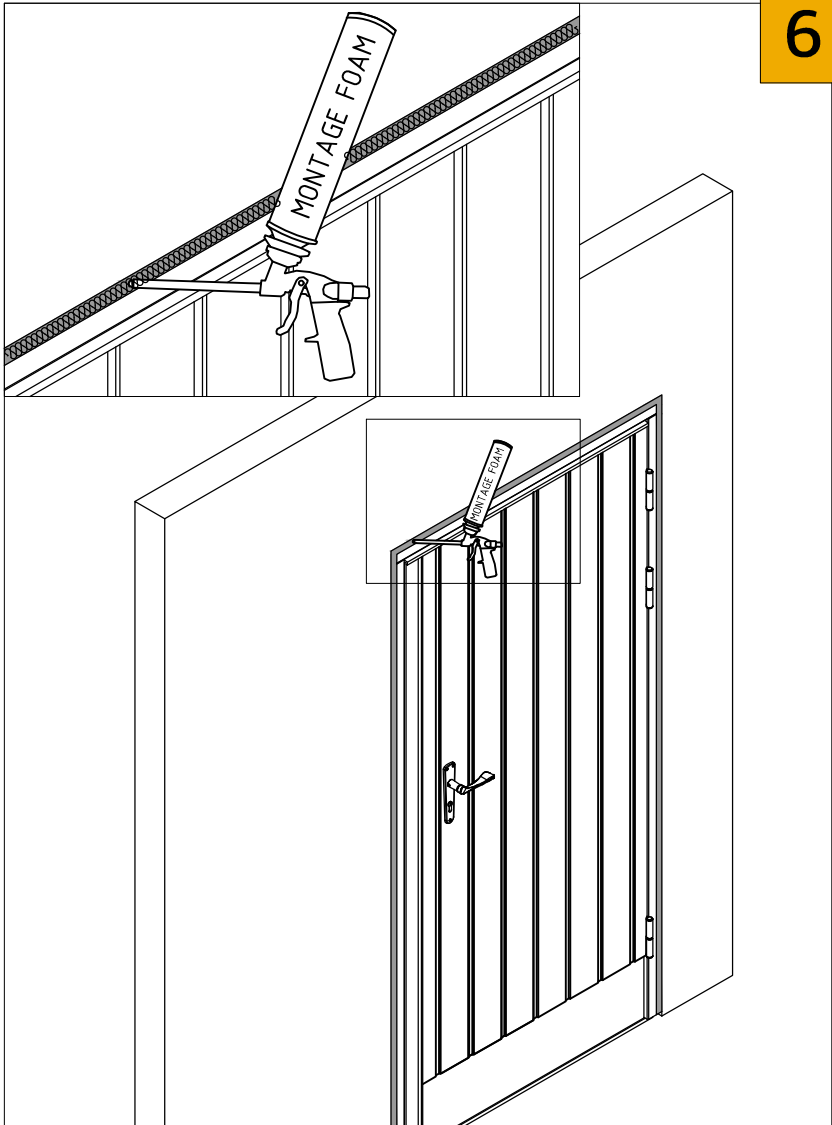

7

