

Installation manual

Montageanleitung • Notice de montage • Istruzioni per il montaggio • Manual de montaje • Monteringsanvisning •
Installatiegids • Montážní návod • Asennusohje • Installationsmanual

Log cabin FR44-4735-2

Blockhaus • Maisonnette en poutres • Casa di travi • Casa de jardin • Anneks • Tuinhuis • Zahradní domek •
Timmerstuga • Hirsimökki

Width 470 x Depth 350 cm











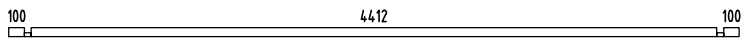
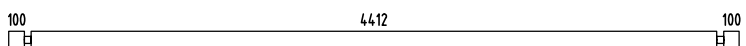
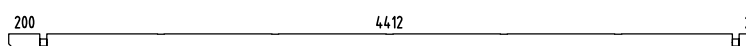
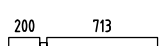

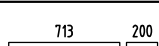
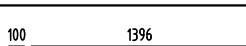
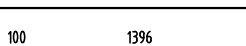

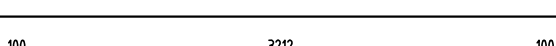
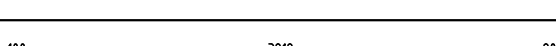
Breite/Tiefe • Largeur/Profondeur • Lunghezza/Profondità • Ancho/Profundidad • Bredde/Dybde • Breedte/Diepte
• Šířka/Hloubka • Leveys/Pituus • Bredd/Längd

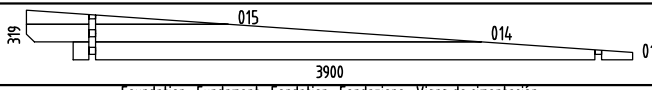
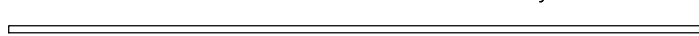
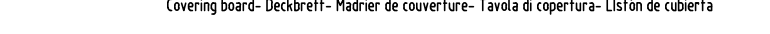
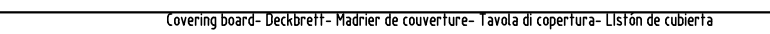
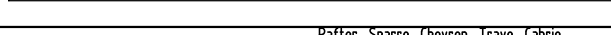







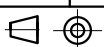

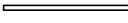















Log thickness 44 mm

Bohlenstärke • Épaisseur des murs • Spessore delle pareti • Grosor de pared • Tykkelse • Wanddicke • Tloušťka
stěny • Seinän paksuus • Väggtjocklek

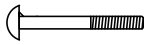

The producer shall have the right to make technical changes to the product • Technische Änderungen vorbehalten • Le
producteur réserve le droit d'effectuer des modifications techniques au produit • Il produttore mantiene il diritto di apportare
modifiche tecniche al prodotto • Reservado el derecho a modificaciones técnicas • Produsent forbeholder seg retten til å endre
tekniske egenskaper ved produktet • Alle rechten en technische wijzigingen voorbehouden • Výrobce si vyhrazuje právo na
technické změny výrobku • Valmistaja pidättää oikeuden tehdä tuotteeseen teknisiä muutoksia • Tillverkaren har rätt att utföra
tekniska förändringar för produkten

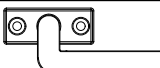
Pos	SPECIFICATION-STÜCKLISTE-NOMENCLATURE-ELEMENTI-ESPECIFICACIÓN "FR44-4735-2"	Pcs	Profile (mm)	Length (mm)
001		1	44x57	4700
002		18	44x114	4700
003		2	44x114	4900
004		2	44x114	957
005		8	44x114	691
006		2	44x114	957
007		2	44x57	1540
008		10	44x114	1540
009		22	44x114	530
010		22	44x114	305
011		34	44x114	3500
012		2	44x114	3600
WA-1		1		
WB-1		1		
AR1	Foundation- Fundament- Fondation- Fondazione- Vigas de cimentación 	7	70x45	4490
CoB1	Covering board- Deckbrett- Madrier de couverture- Tavola di copertura- Listón de cubierta 	1	19x120	4940
CoB2	Covering board- Deckbrett- Madrier de couverture- Tavola di copertura- Listón de cubierta 	2	19x95	4940
RoR1	Rafter- Sparre- Chevron- Trave- Cabrio 	5	44x140	3917
RoR2	Rafter- Sparre- Chevron- Trave- Cabrio 	4	44x140	200
FB2-1	Floor board- Fussbodenbrett- Madrier du plancher - Tavola pavimento- Tabla de suelo 	50	89x19	3205
RB2-1	Roof board- Dachbrett- Madrier du toit- Tavola tetto- Tabla de tejado 	44	89x19	980
RB2-2		44	89x19	3920
FaB6-1	Facia board- Giebelblende- Écran frontal- Schermo frontone- Tabla de facia 	4	19x95	3920
FIB2-1	Floor beading- Fussbodenleiste- Baguette du plancher- Listello pavimento- Listón de suelo 	7	19x19	2244
RE2-1	Roof edge reinforcement- Dachrandleiste- Baguette en bordure du toit- Rinforzo bordo tetto- Refuerzo borde tejado 	2	32x40	3210
QTI8-1	Seal- Gummidichtung- Joint d'isolation- Guarnizione- Burlete 	2	A44-81	3700
	Object name "FR44-4735-2"	Page 1/3		

Pos	SPECIFICATION-STÜCKLISTE-NOMENCLATURE-ELEMENTI-ESPECIFICACIÓN "FR44-4735-2"	Pcs	Profile (mm)	Length (mm)
QT18-2	Seal- Gummidichtung- Joint d'isolation- Guarnizione- Burlate 	1	TU44-81P	5500
Sla10-1	Slat- Leiste- Baguette- Llistello- Listón 	1	19x45	1620
StB1-1	Storm brace- Sturmleiste- Protection contre le vent- Antivento- Protector contra tormentas 	2	25x45	2050
StB1-2	Storm brace- Sturmleiste- Protection contre le vent- Antivento- Protector contra tormentas 	2	25x45	2250
Fim	-Fixing kit- Befestigungsset- Moyens de fixation- Materiale di fissaggio- Kit de fijación 	1	USE	
QPOYP8x 80Zn	Bolt -Schloss-schraube -Boulon- Bullone- Perno- M8x80mm PUP0 	8	StB1-x	
QULS130x 35	Cylinder- Zylinderschloss- Serrure a mortaiser- Serratura a cilindro- Bombin- 30.35 	1	TU44-81P	
QLIU KAPal	Door fittings- Türbeschlag- Ferrure- Ferramenta porta- Manilla puerta- QLIUKAPal 	1	TU44-81P	
QRV120Zn	Keeper- Schliessblech- Tole- Lamiera- Aldaba de candado 	1	TU44-81P	
QNA1 4x 40Me	Nail- Nagel- Clou- Chiodo- Clavo- 1.4x40mm 	40	FB2-1	
QNA2 2 x50Zn	Nail- Nagel- Clou- Chiodo- Clavo- 2.5x50mm 	380	FB2-1	
QNA3x70 Zn	Nail- Nagel- Clou- Chiodo- Clavo- 3x70mm 	450	RB2-1	
QMUKK8 Zn	Nut- Schraubenmutter- Écrou- Dado- Tuerca- M8mm 	8		
QKRPP2 _5x16Z n	Screw- Schraube- Vis- Vite- Tornillo- 2.5x16mm 	2		
QKRPP3x 20Zn	Screw- Schraube- Vis- Vite- Tornillo- 3x20mm 	28	TU44-81P; A44-81	
QKRPP4 _5x50Zn	Screw- Schraube- Vis- Vite- Tornillo- 4.5x50mm 	120	CoBx; FaBx; RE2-1;...	
QKRPP4 _5x70Zn	Screw- Schraube- Vis- Vite- Tornillo- 4.5x70mm 	20	001; 004; 006; 007	
QKRPP5x 90Zn	Screw- Schraube- Vis- Vite- Tornillo- 5x90mm 	24	TU44-81P; 005; 004	
QKRPP6x 120Zn	Screw- Schraube- Vis- Vite- Tornillo- 6x120mm 	8	RoR2+Wall	
QKRPP6x 180Zn	Screw- Schraube- Vis- Vite- Tornillo- 6x180mm 	10	RoR1+Wall	
QSE8x22 Zn	Washer- Dichtscheibe- Joint- Rondella- Arandela- 8x22mm 	8		
QLIA-P	Window fittings- Fenstergriff- Poigne de la fenêtre- Maniglia finestra- Manilla- QLIA-P 	1	A44-81	
QLIA-V	Window fittings- Fenstergriff- Poigne de la fenêtre- Maniglia finestra- Manilla- QLIA-V 	1	A44-81	
QFK240Z n	Window stop- Fensterfeststelle- Crémaillere- Fissativo finestra- Fijador de ventana- QFK240Zn 	2	A44-81	

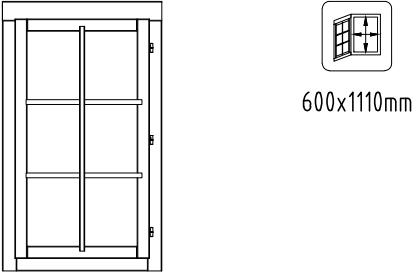
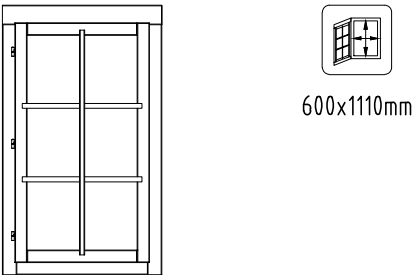
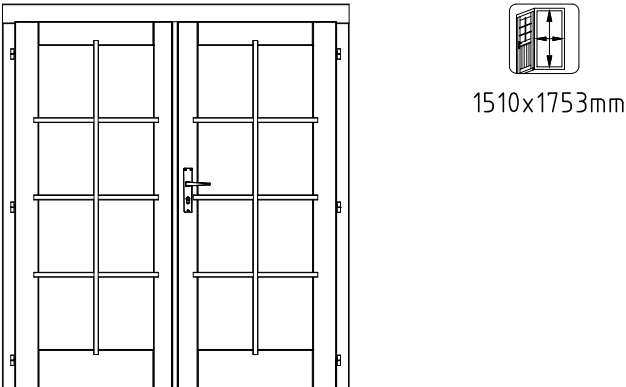
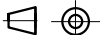

Pos	SPECIFICATION-STÜCKLISTE-NOMENCLATURE-ELEMENTI-ESPECIFICACIÓN "FR44-4735-2"	Pcs	
A44-81V	<p data-bbox="475 230 1043 259">Window - Fenster - Fenetre - Finestra-Ventana 700x1210</p> 	1	
A44-81P	<p data-bbox="475 633 1043 663">Window - Fenster - Fenetre - Finestra-Ventana 700x1210</p> 	1	
TU44-81 P	<p data-bbox="536 1037 983 1066">Door - Tür - Porte - Porta-Puerta 1610x1822</p> 	1	
	Object name "FR44-4735-2"	Page 3/3	

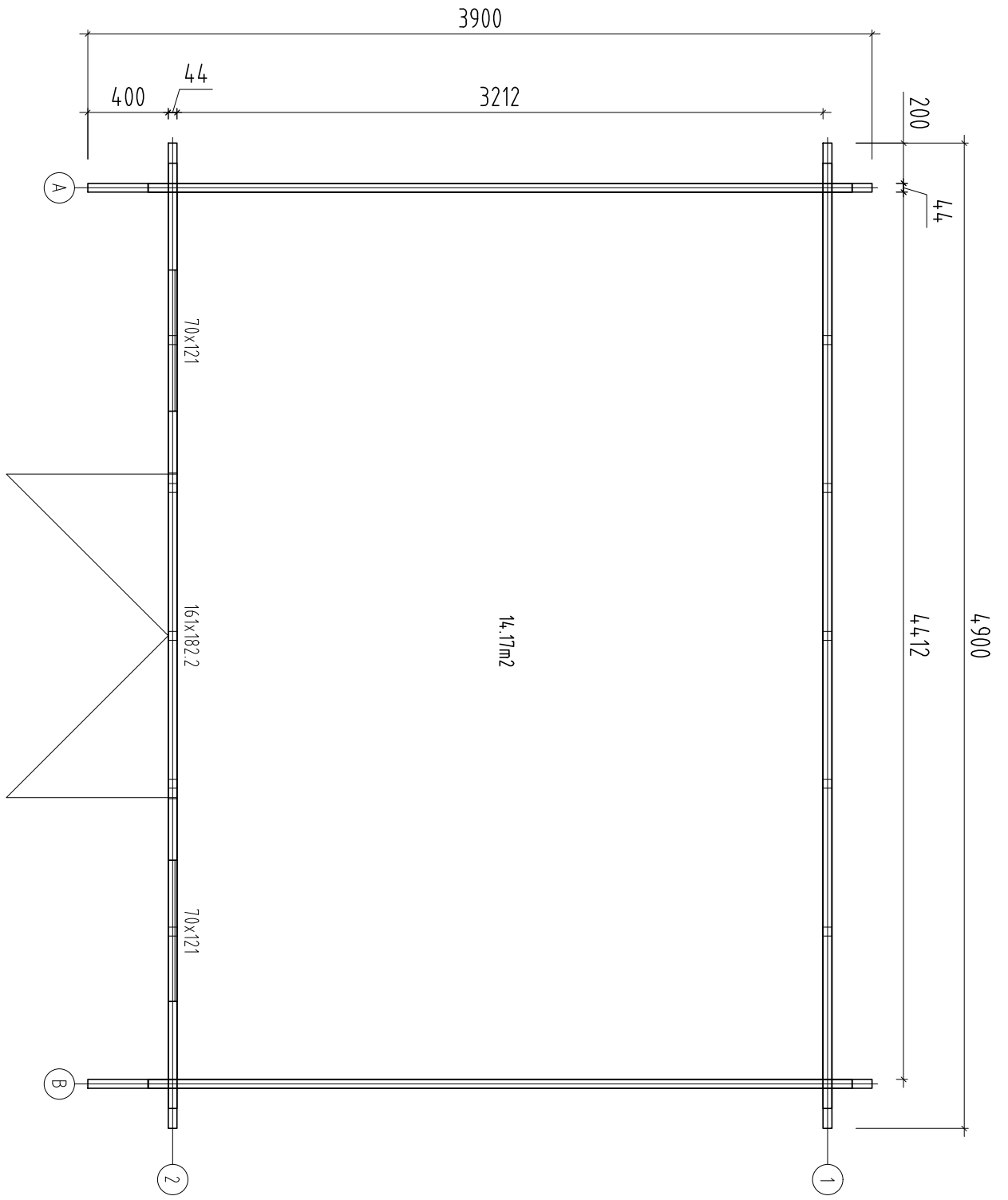

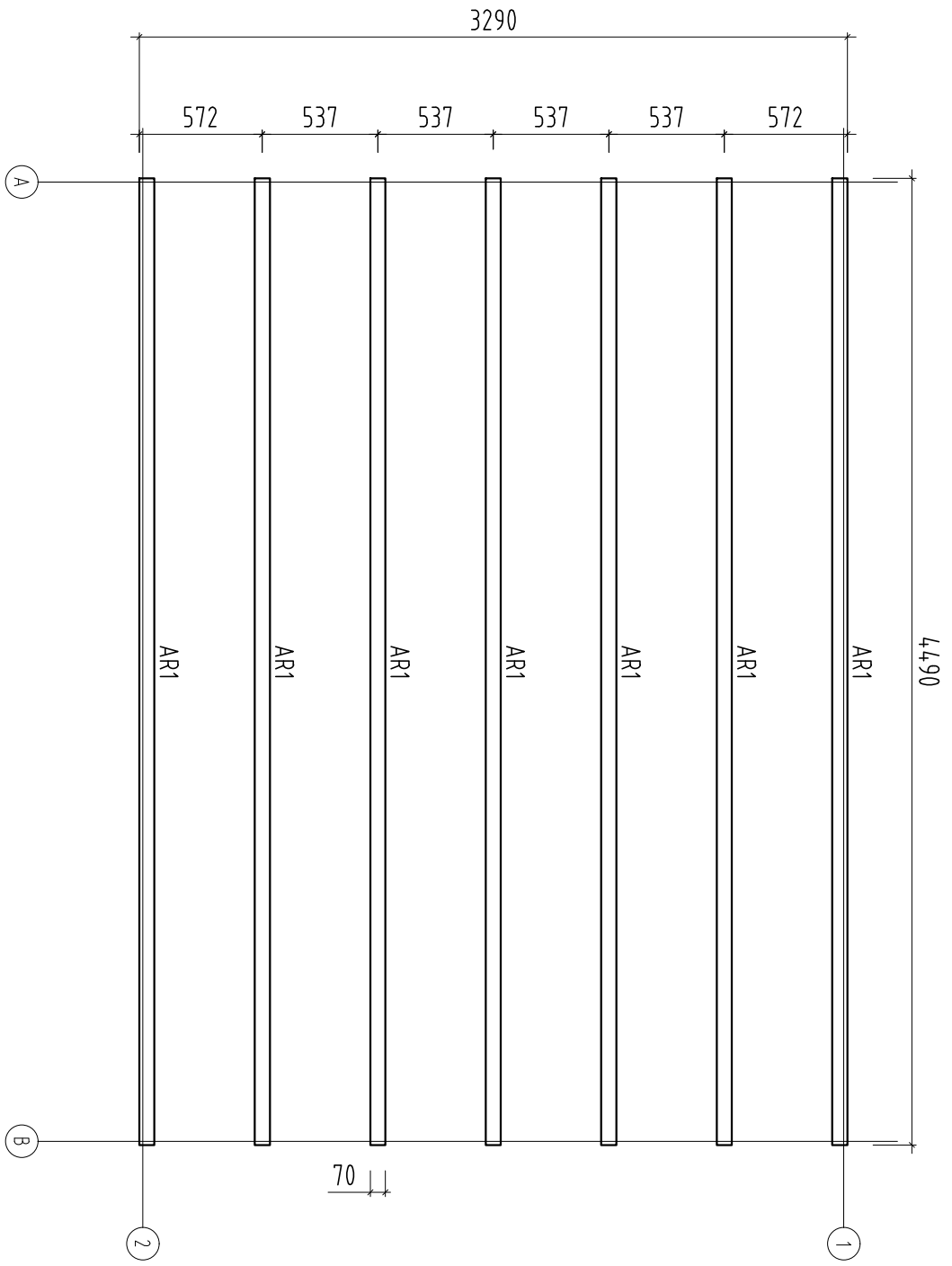

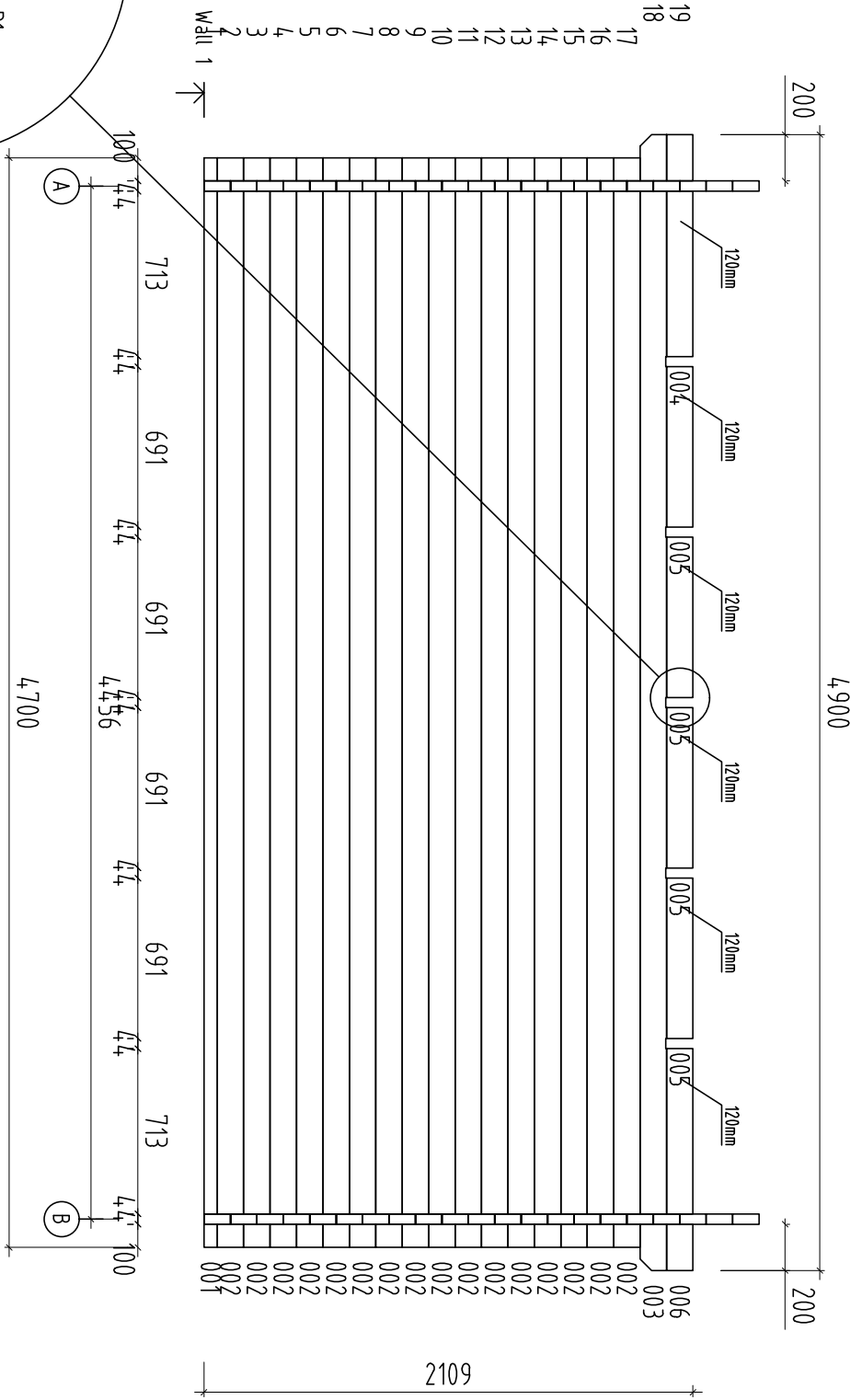
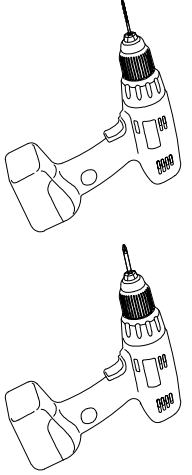
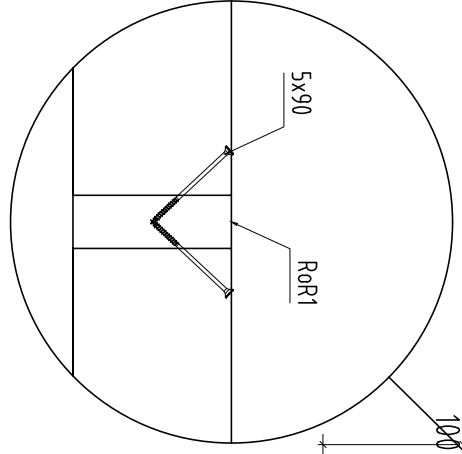

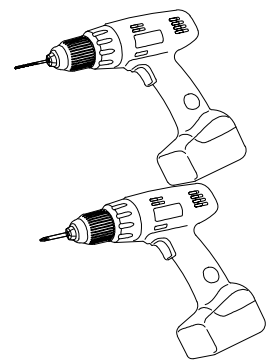
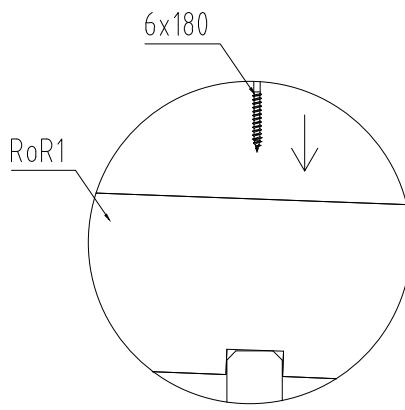
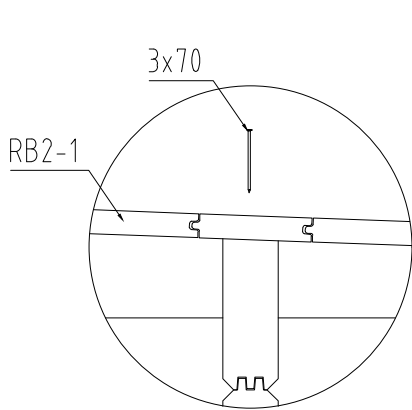
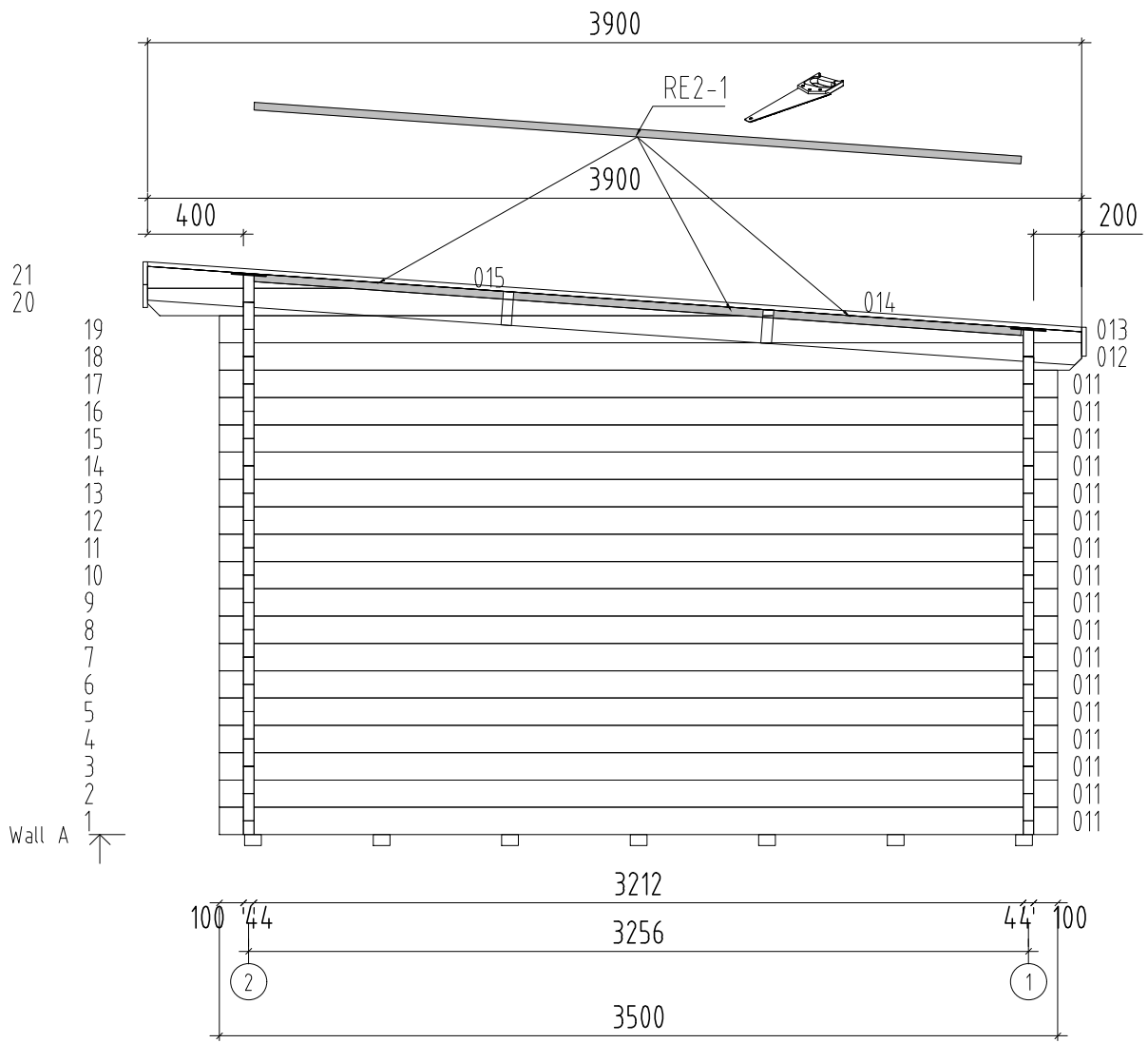

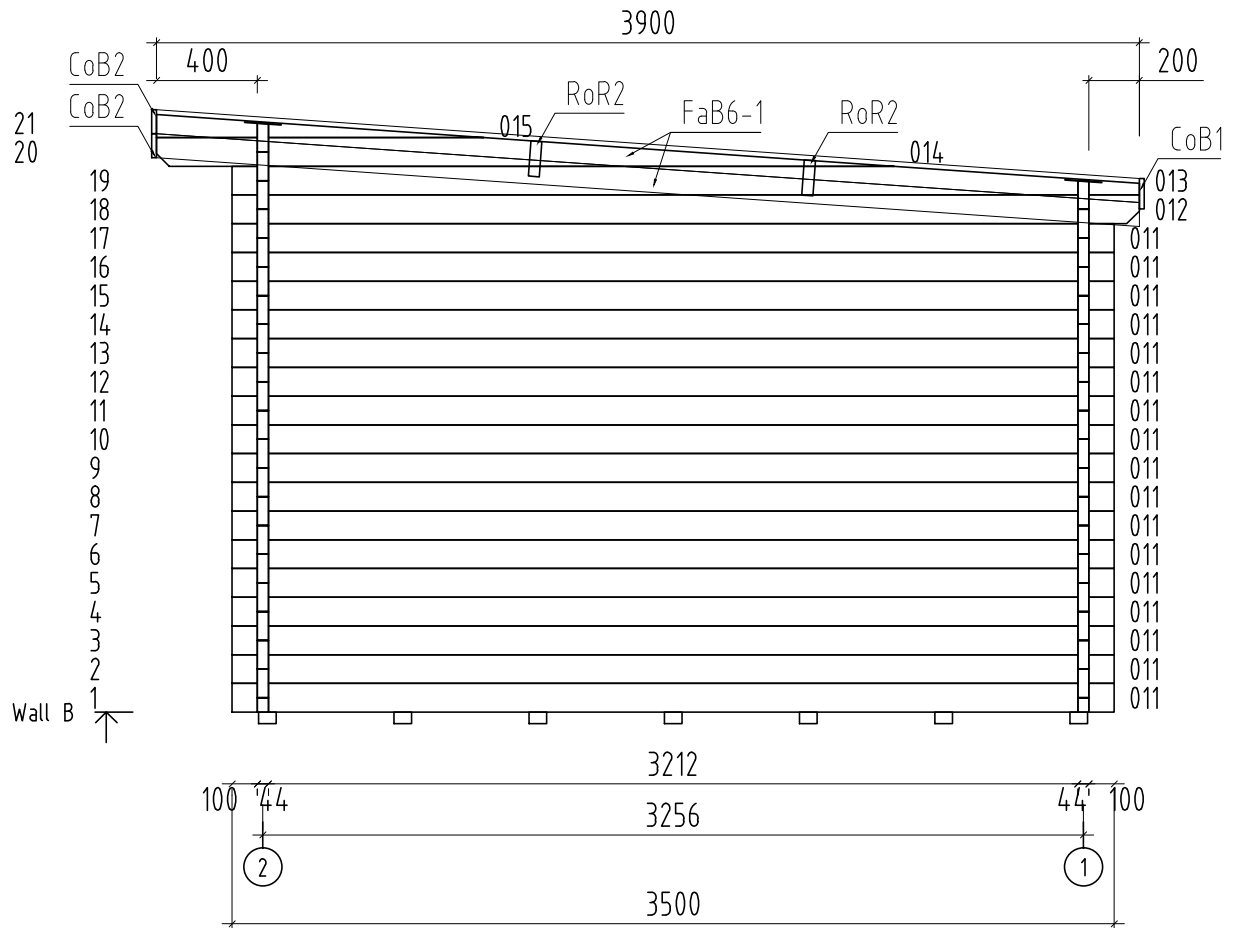

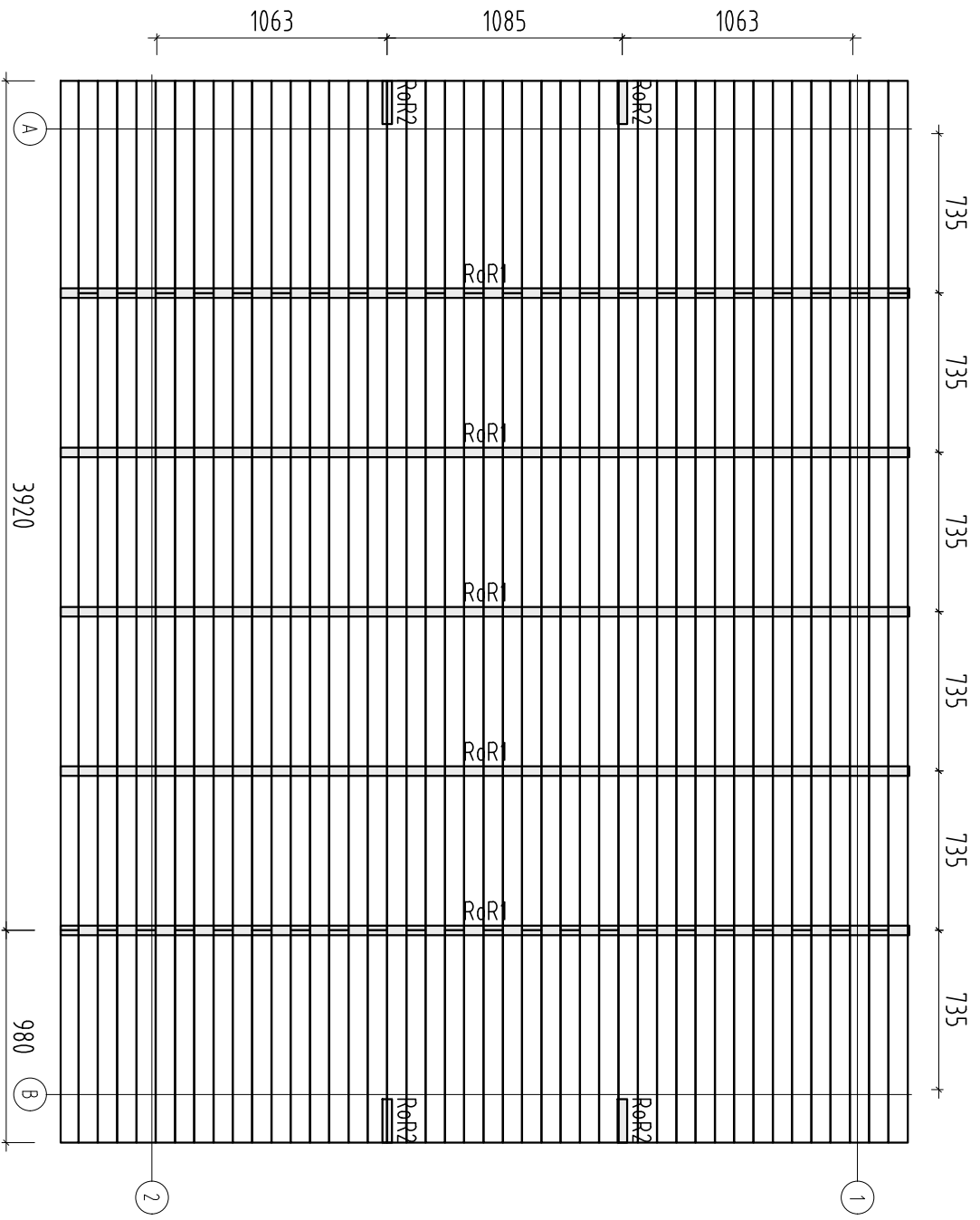

Rafter - Sparre - Chevron - Trave - Cabrio
 Roof board - Dachbrett - Madrier du toit - Tavola
 tetto - Tabla de tejado

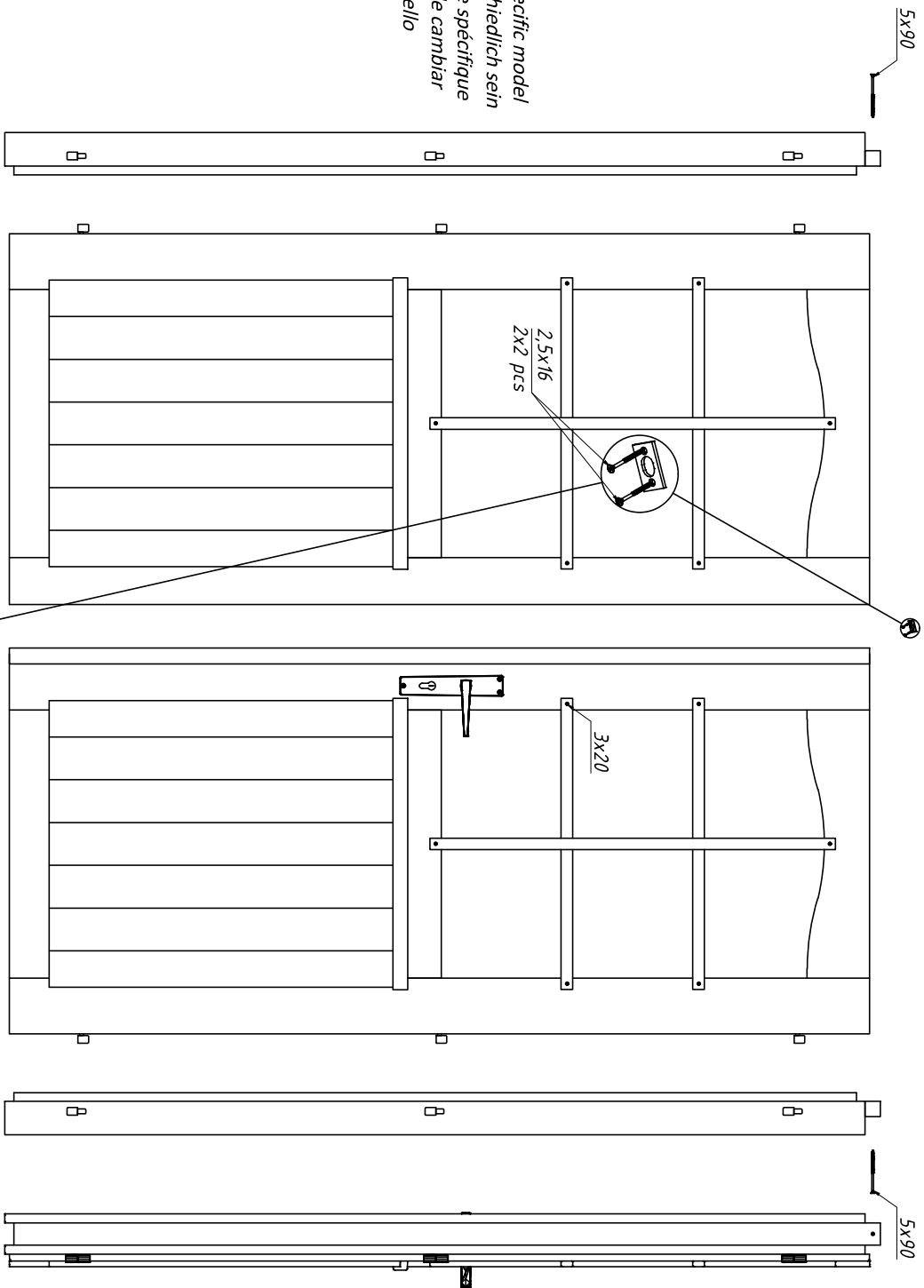
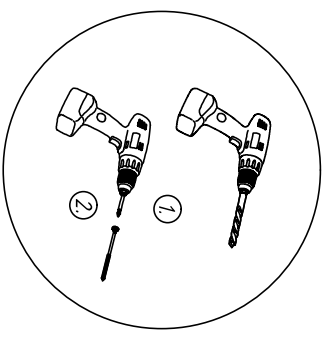
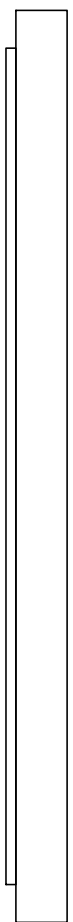
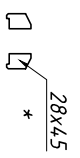
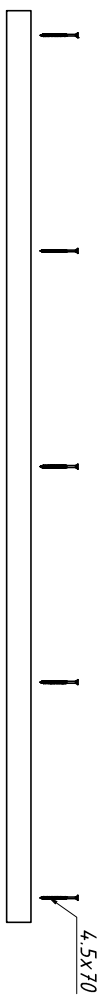

* The specification may vary depending on the specific model
 * Die Spezifikation können je nach Modell unterschiedlich sein
 * Les spécifications peuvent varier selon le modèle spécifique
 * Dependiendo del modelo, la especificación puede cambiar
 * Le specifiche possono variare a seconda del modello

