

PREPARE THE GROUND, UNWRAP THE PACKAGE,  
LAY OUT THE COMPONENTS, FIND THE TOOLS.

# BERGEN 40

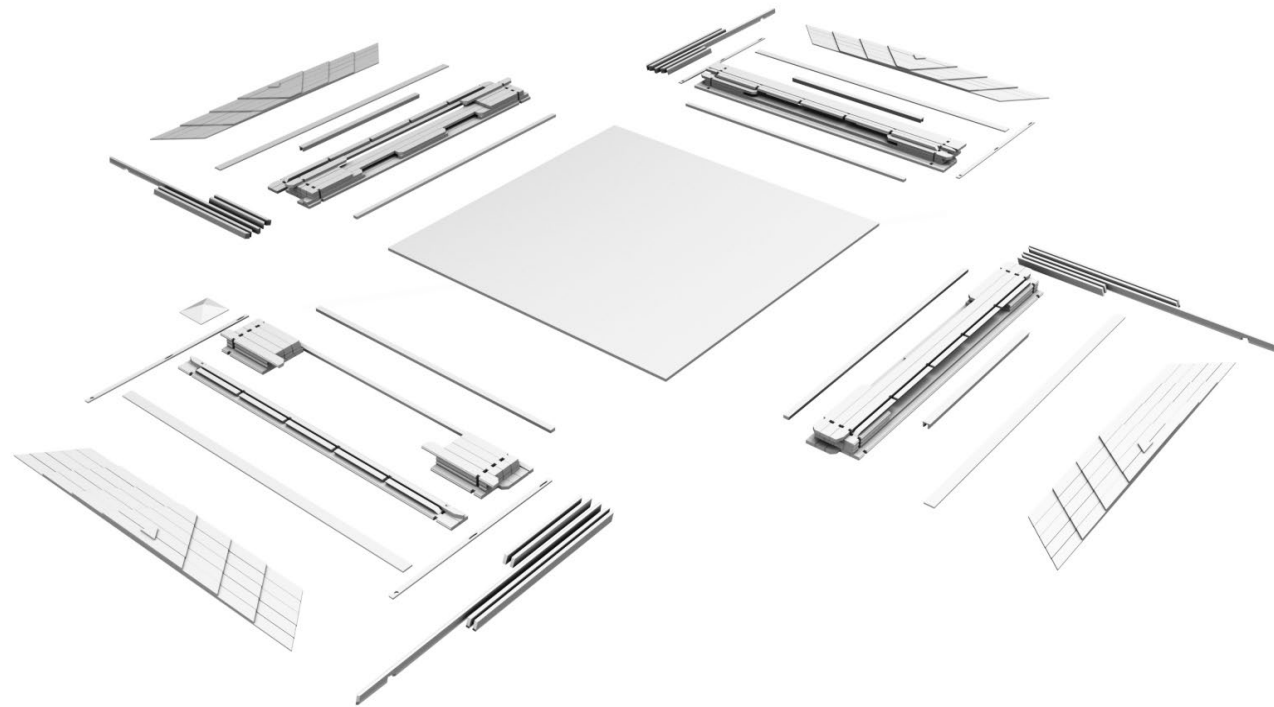
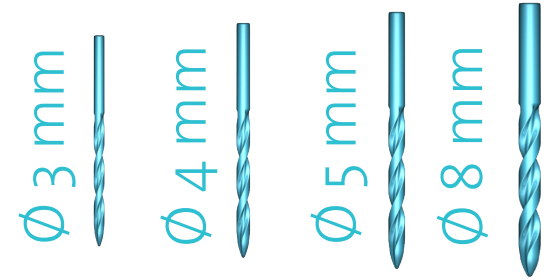
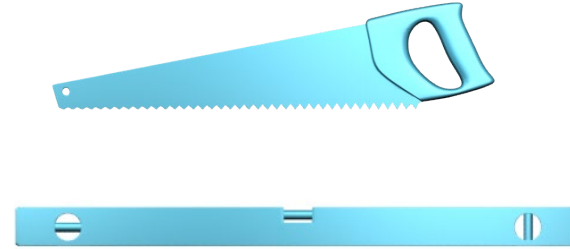
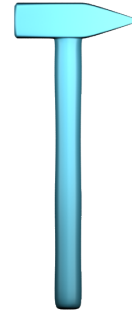
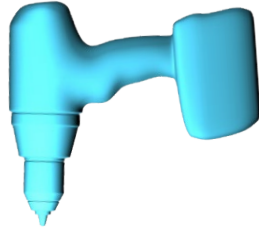
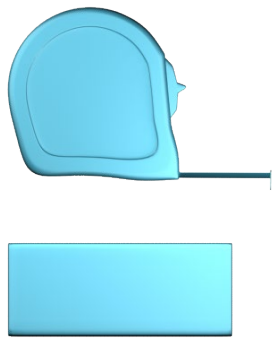

4x40 × 110

4x50 × 450

5x70 × 35

6x140 × 100

M8x70 × 12

LAY OUT THE FOUNDATION BEAMS AND SQUARE IT BY MEASURING FROM CORNER TO CORNER.

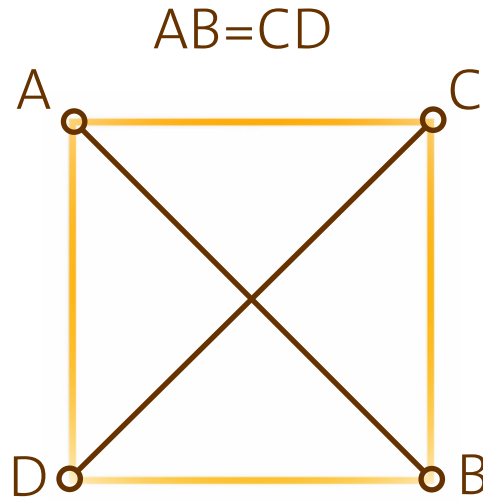
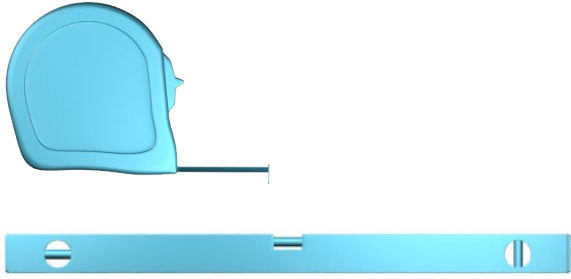

BERGEN 40

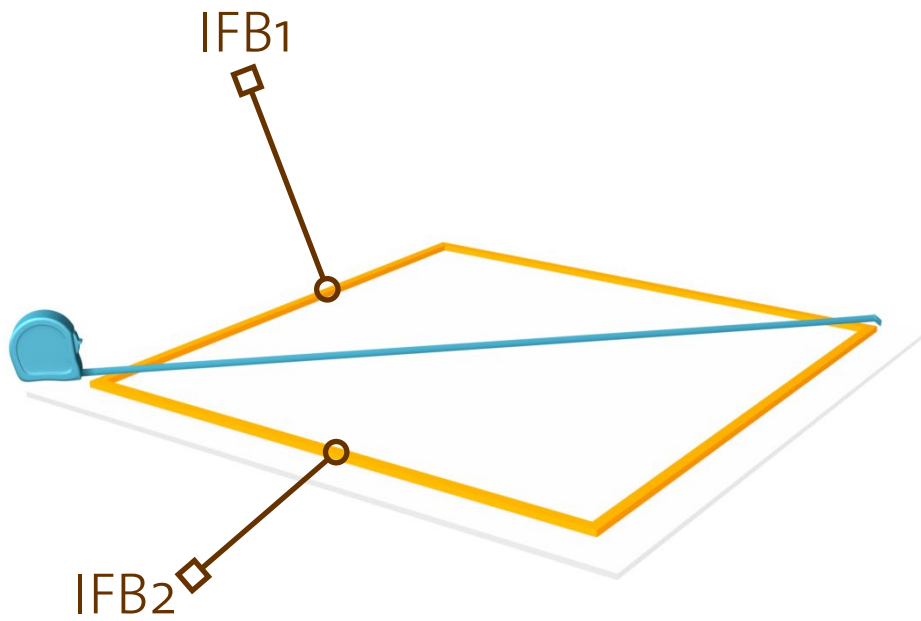
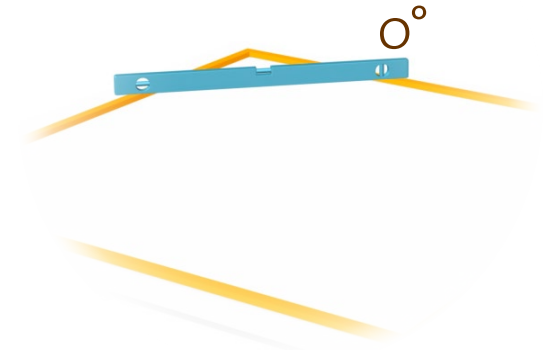

MAKE SURE THAT THE FOUNDATION IS INSTALLED ON A LEVEL SURFACE. CHECKING ALL DIRECTIONS, INCLUDING CORNER TO CORNER. 1%

ATTACH FOUNDATION BEAMS WITH SCREWS.

BERGEN 40

6x140 × 4  
Ø 5 mm

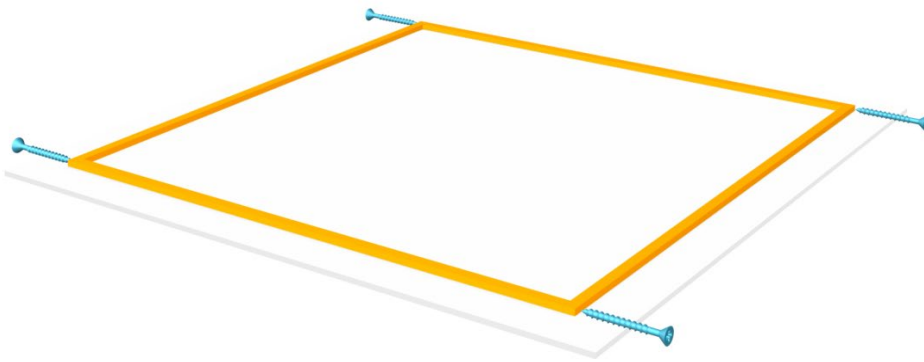
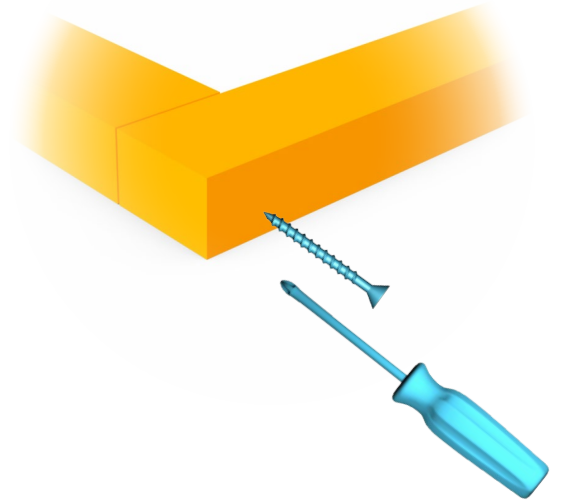
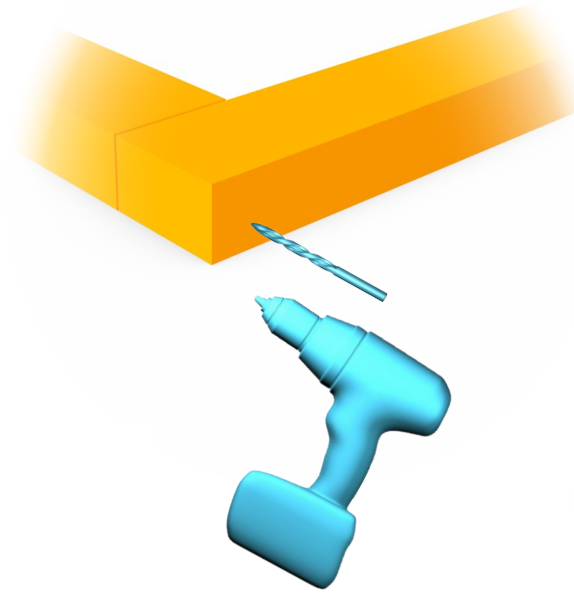

ATTACH LOGS TO THE FOUNDATION.

BERGEN 40

$5 \times 70 \times 6$   
 $6 \times 140 \times 10$   
 $\varnothing 4 \text{ mm}$   
 $\varnothing 5 \text{ mm}$

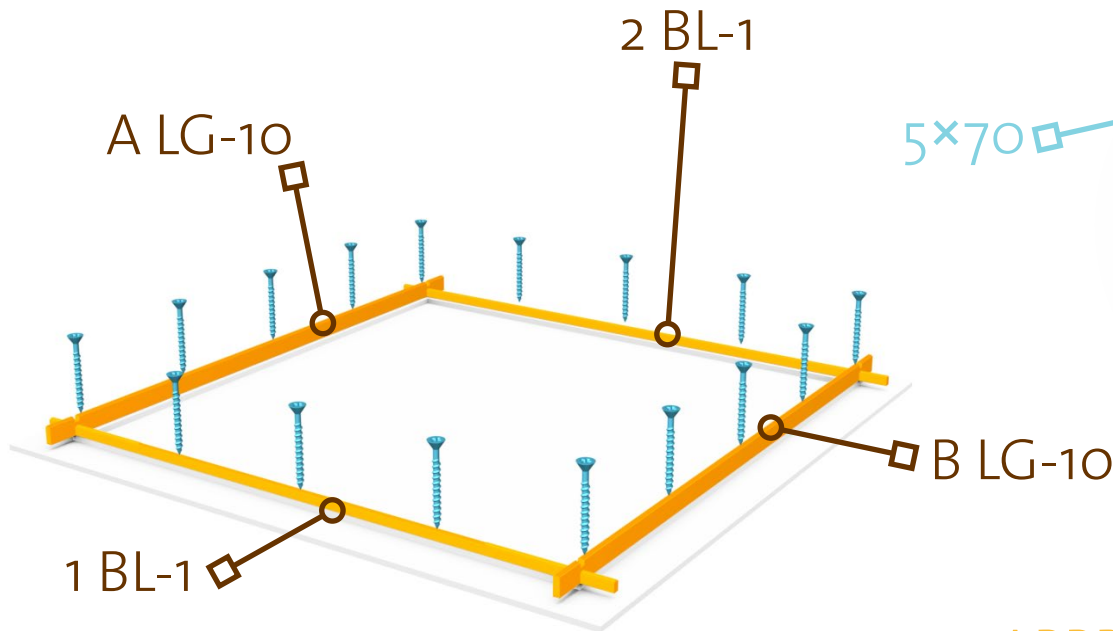
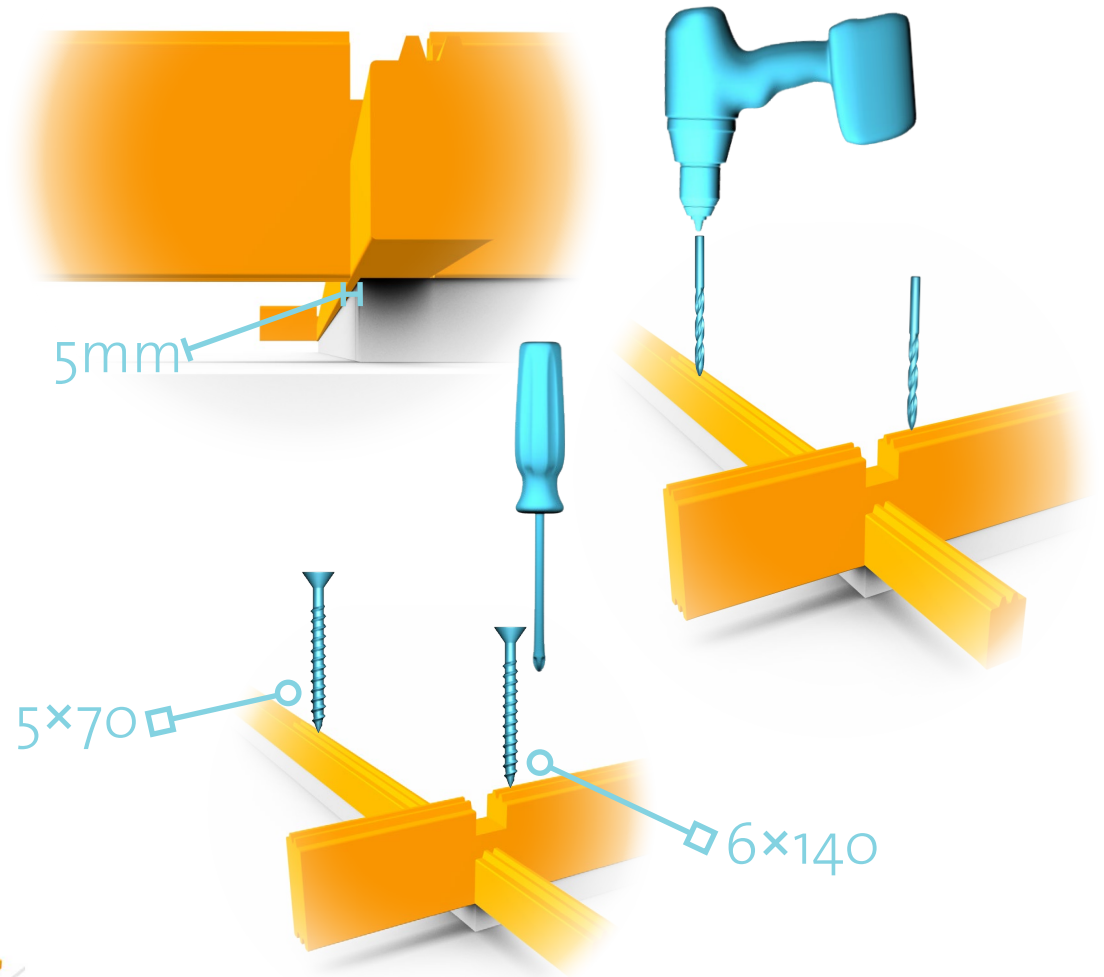

THE WALL LOGS WILL HANG OVER THE FOUNDATION BEAMS BY APPROXIMATELY 5MM. THIS OVERHANG IS DESIGNED AS A RAIN DRIP. 3%

ATTACH THE NEXT ROW OF WALL LOGS INTO THE BOTTOM LOGS WITH SCREWS.

- 5x70 × 4
- 6x140 × 5
- Ø 4 mm
- Ø 5 mm

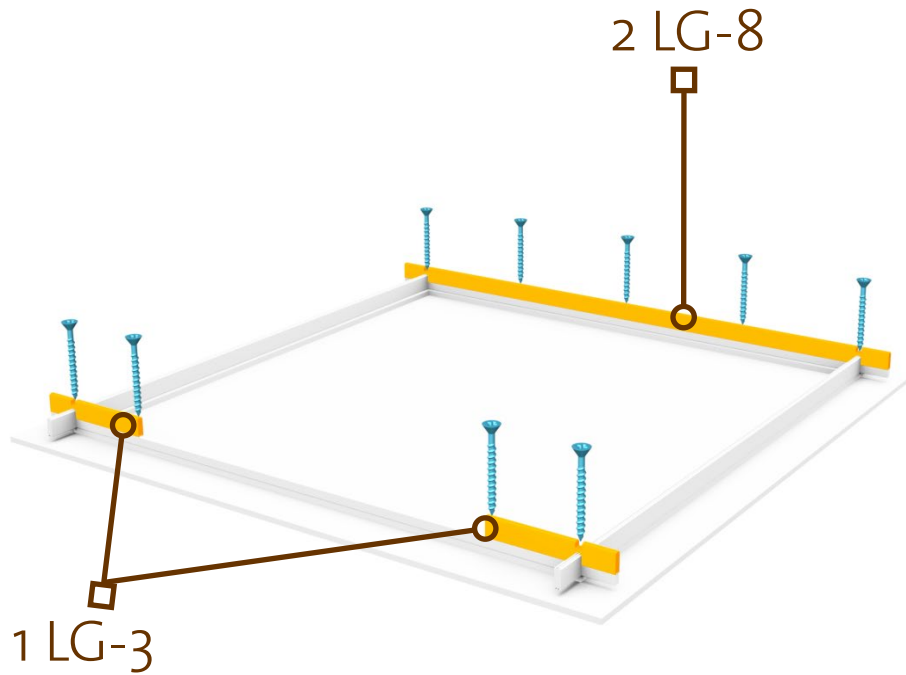
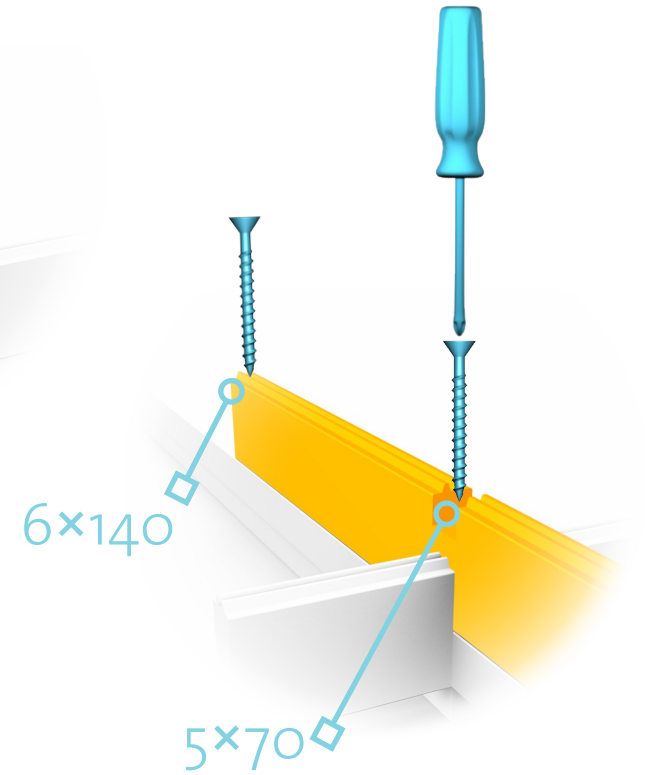
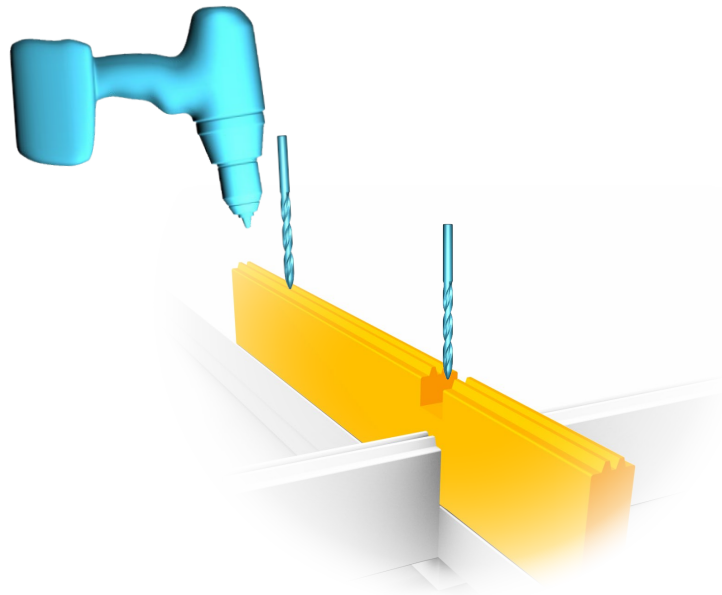

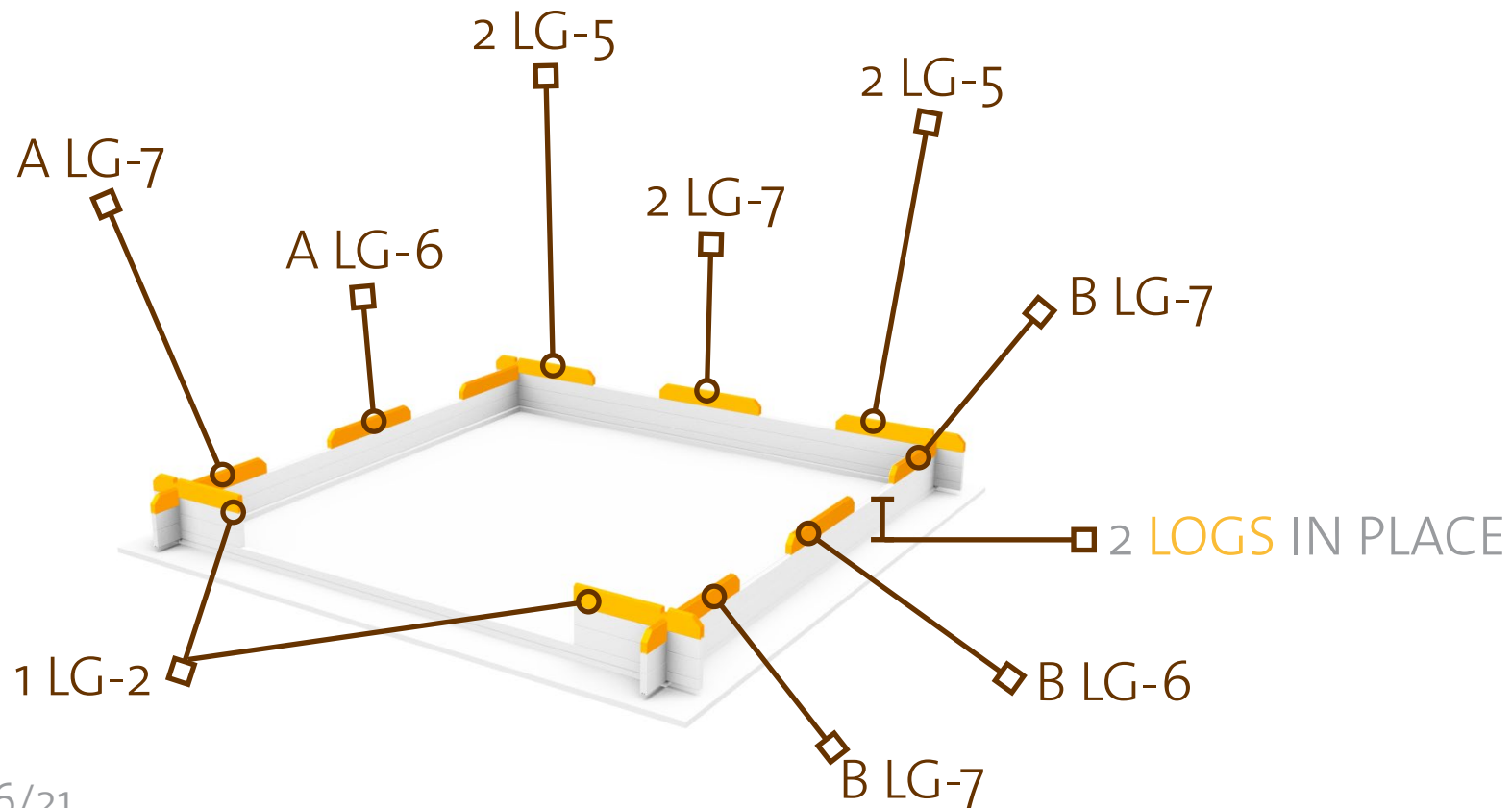

AFTER PLACING 3-4 ROWS OF WALL LOGS, TAP EACH WALL LOG IN PLACE USING A HAMMER AND THE HITBLOCK PROVIDED, TO TIGHTEN THE LOGS.

BERGEN 40

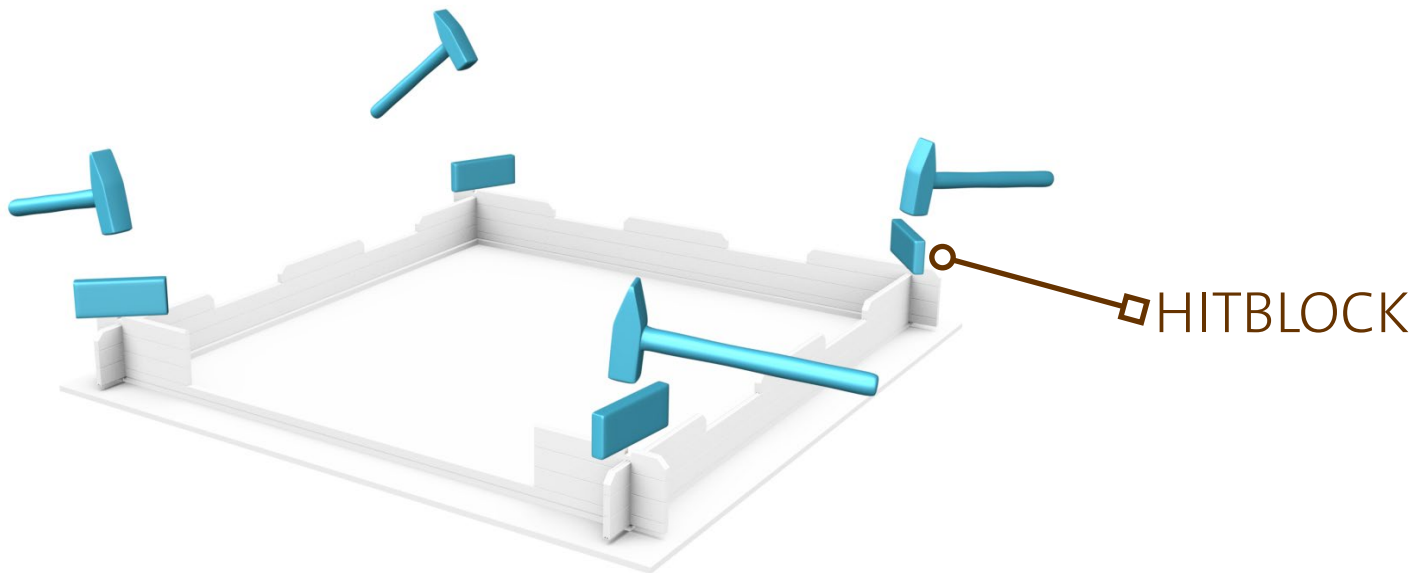

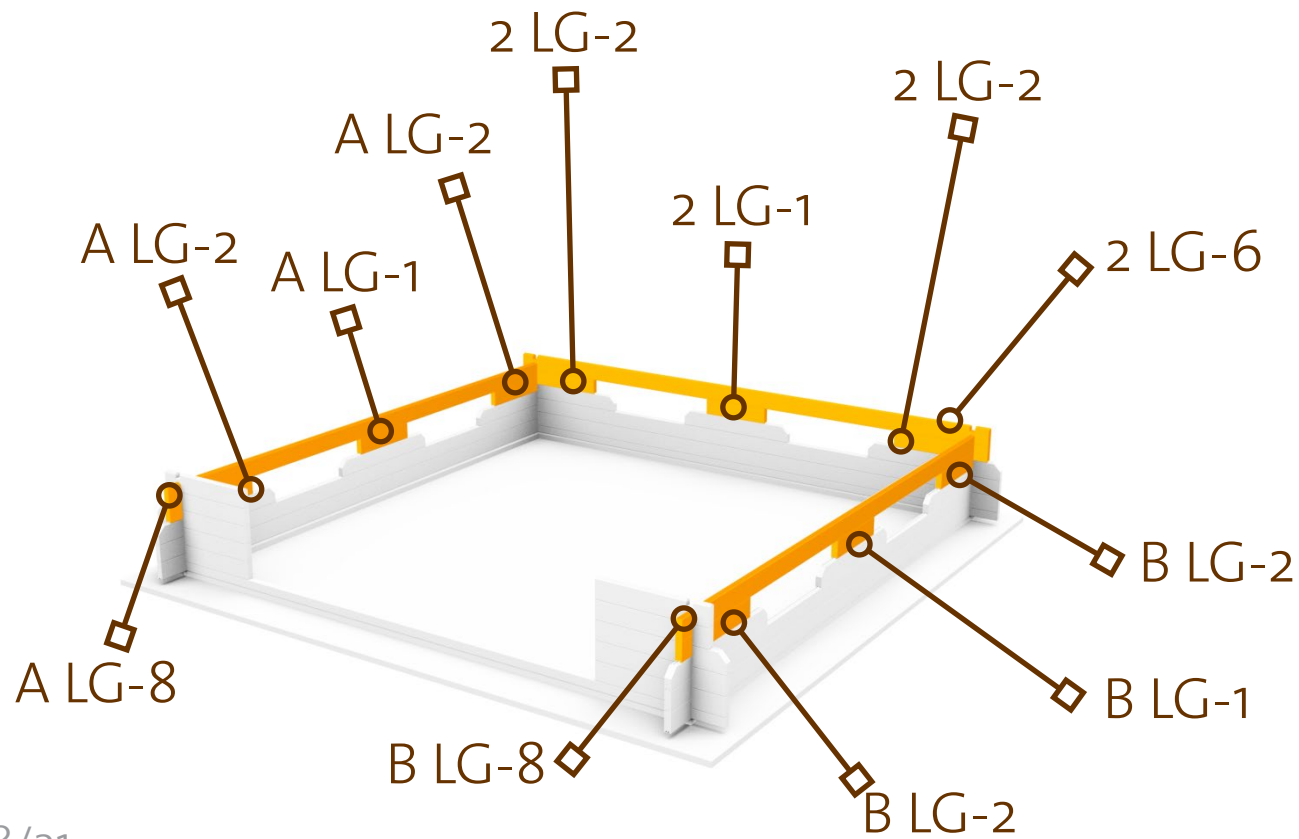



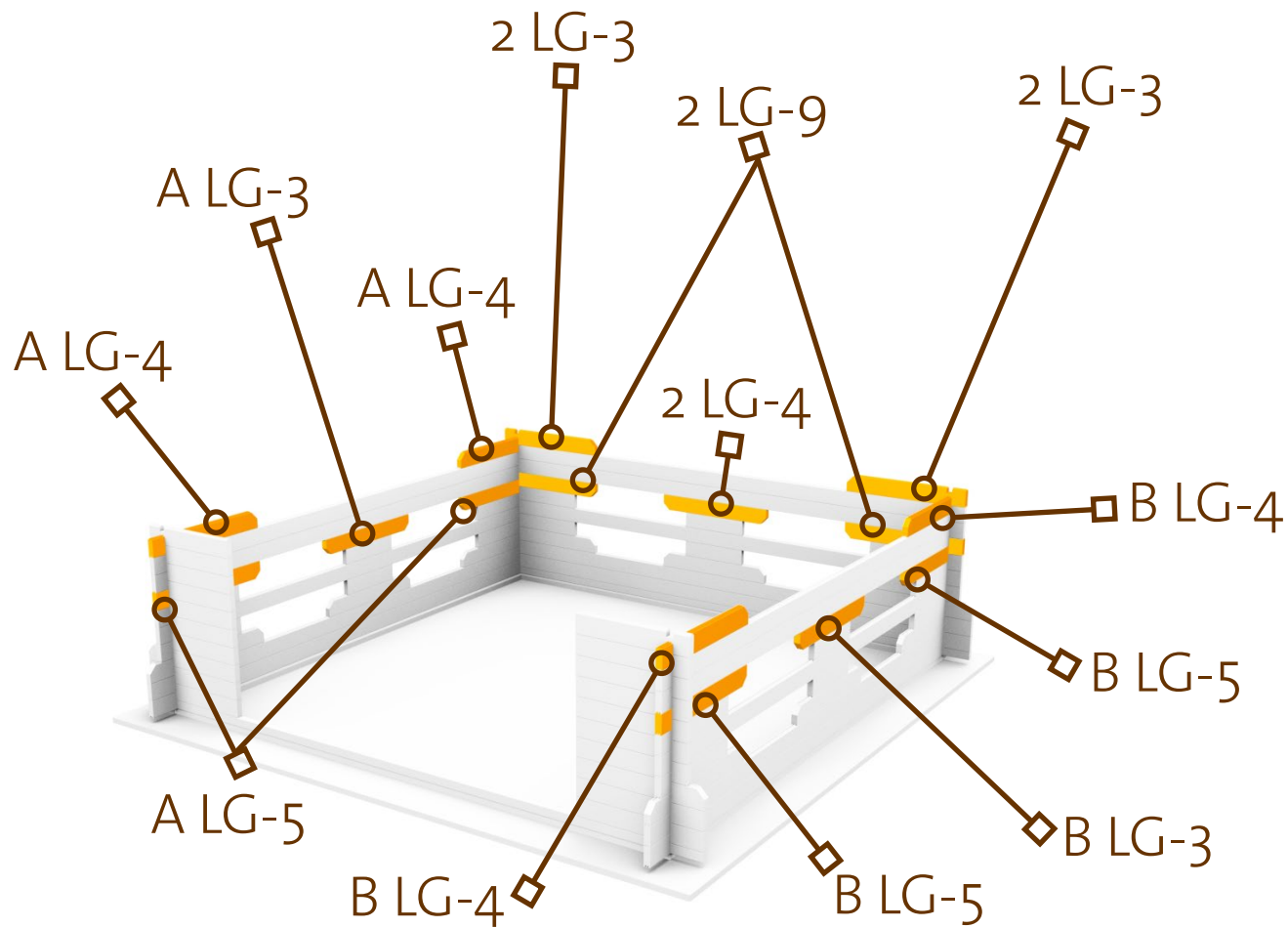

DON`T FORGET TO  
**TIGHTEN** THE LOGS AFTER  
EVERY 3-4 ROWS.

BERGEN 40

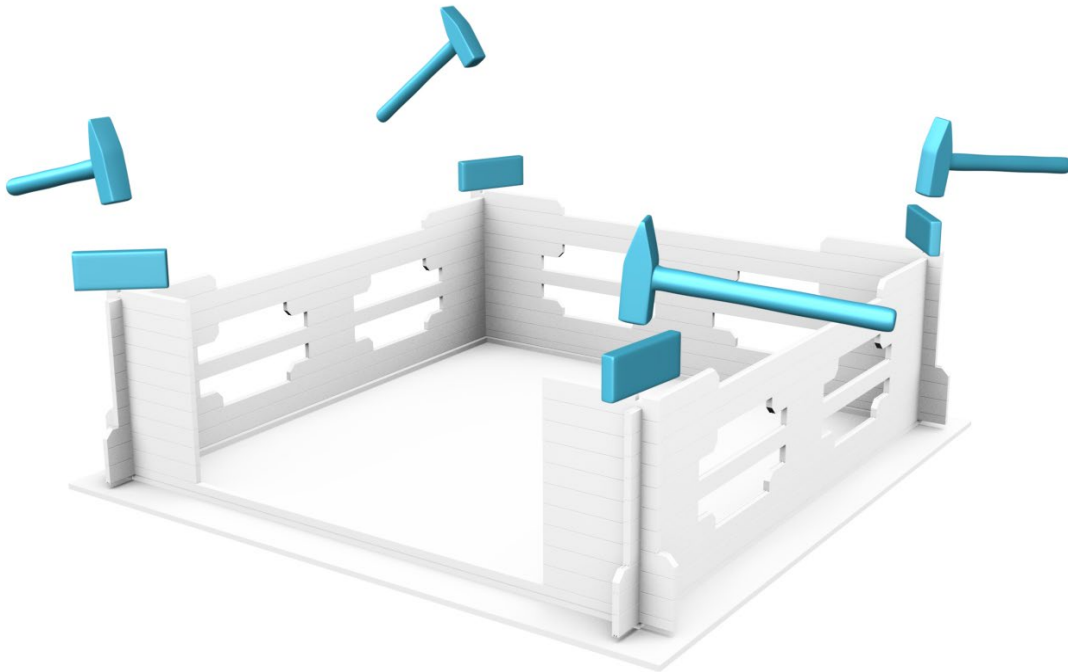

ATTACH **HANDRAILS** INTO WALL LOGS WITH SCREWS.

BERGEN 40

4x40 × 36  
Ø 3 mm

HR1

HR2

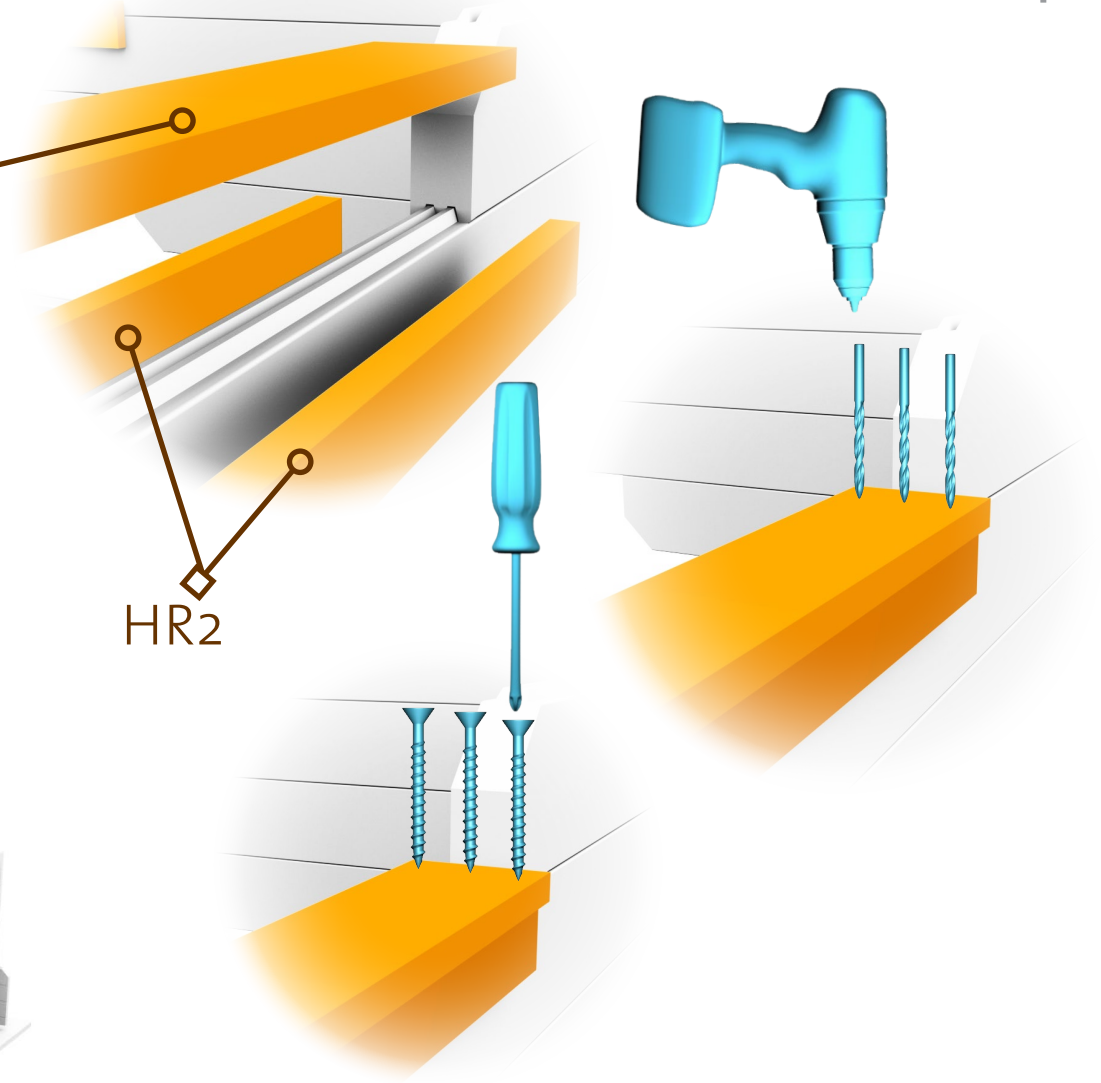
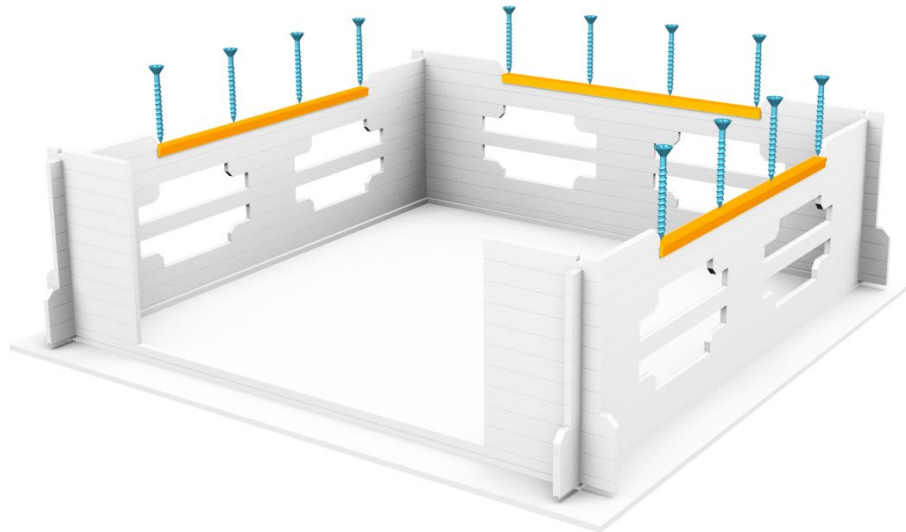

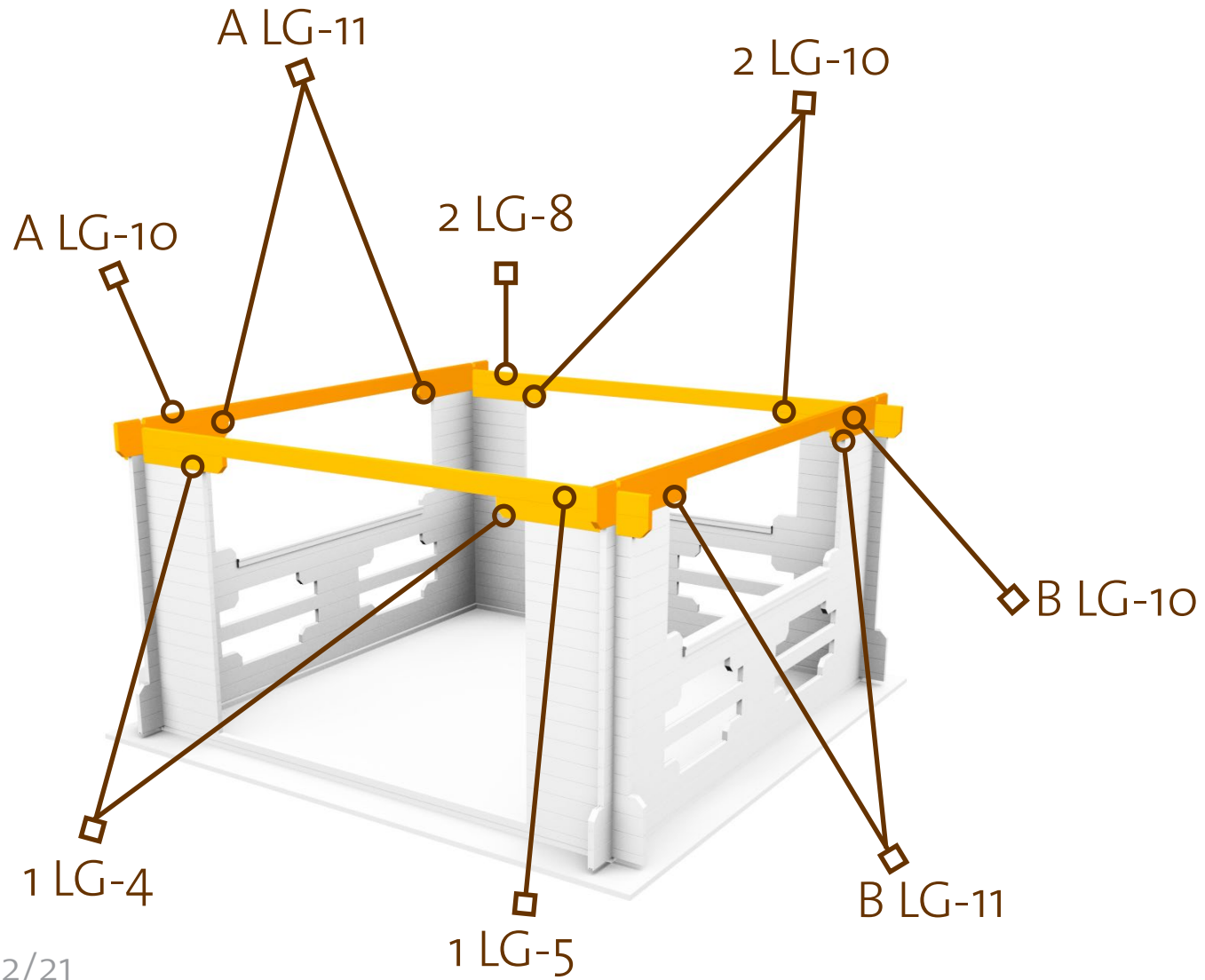

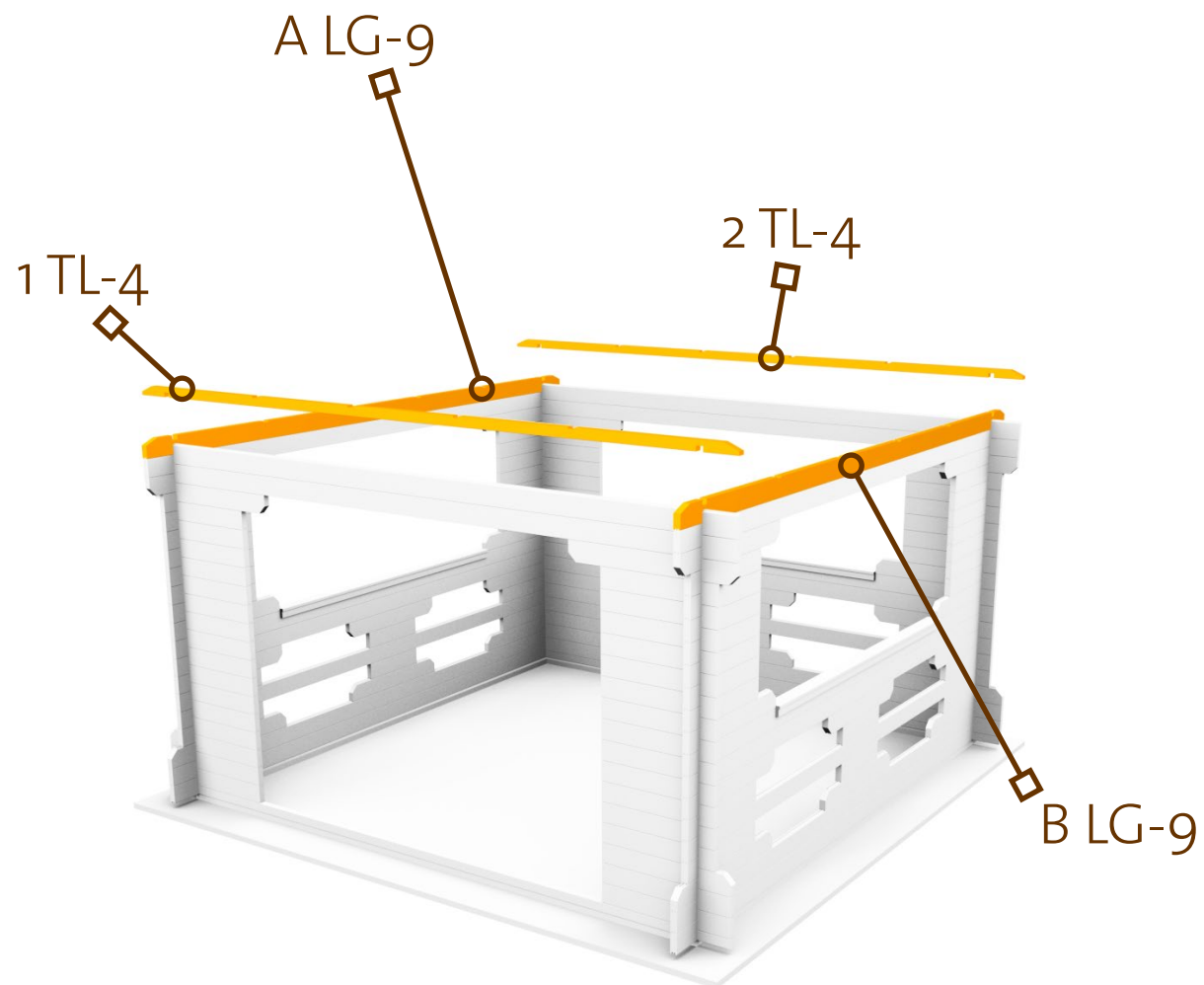

ATTACH TOP LOGS INTO WALL LOGS WITH SCREWS.

BERGEN 40

6x140 × 40

Ø 5 mm

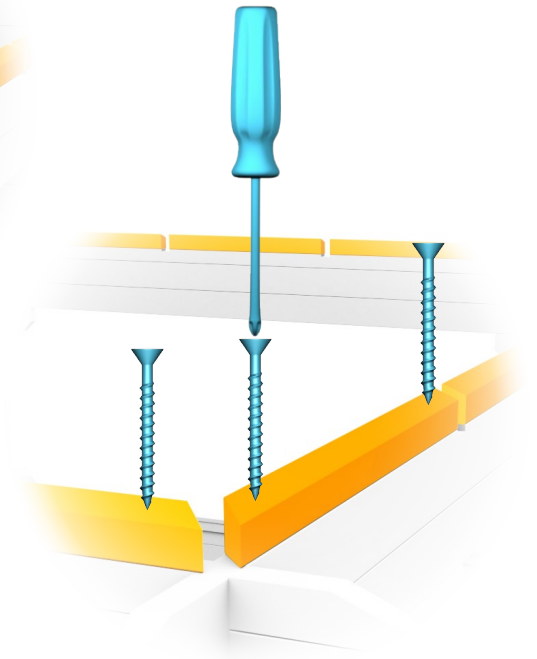
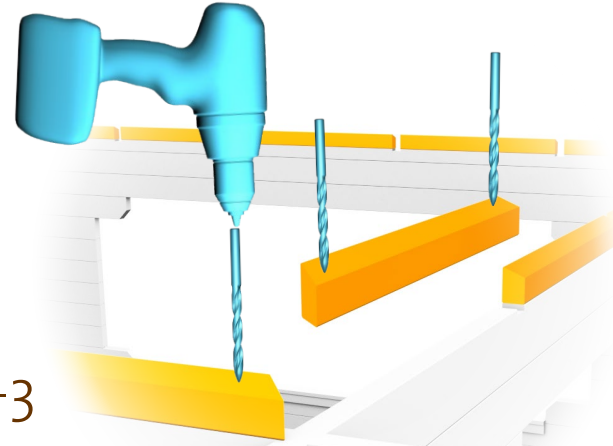
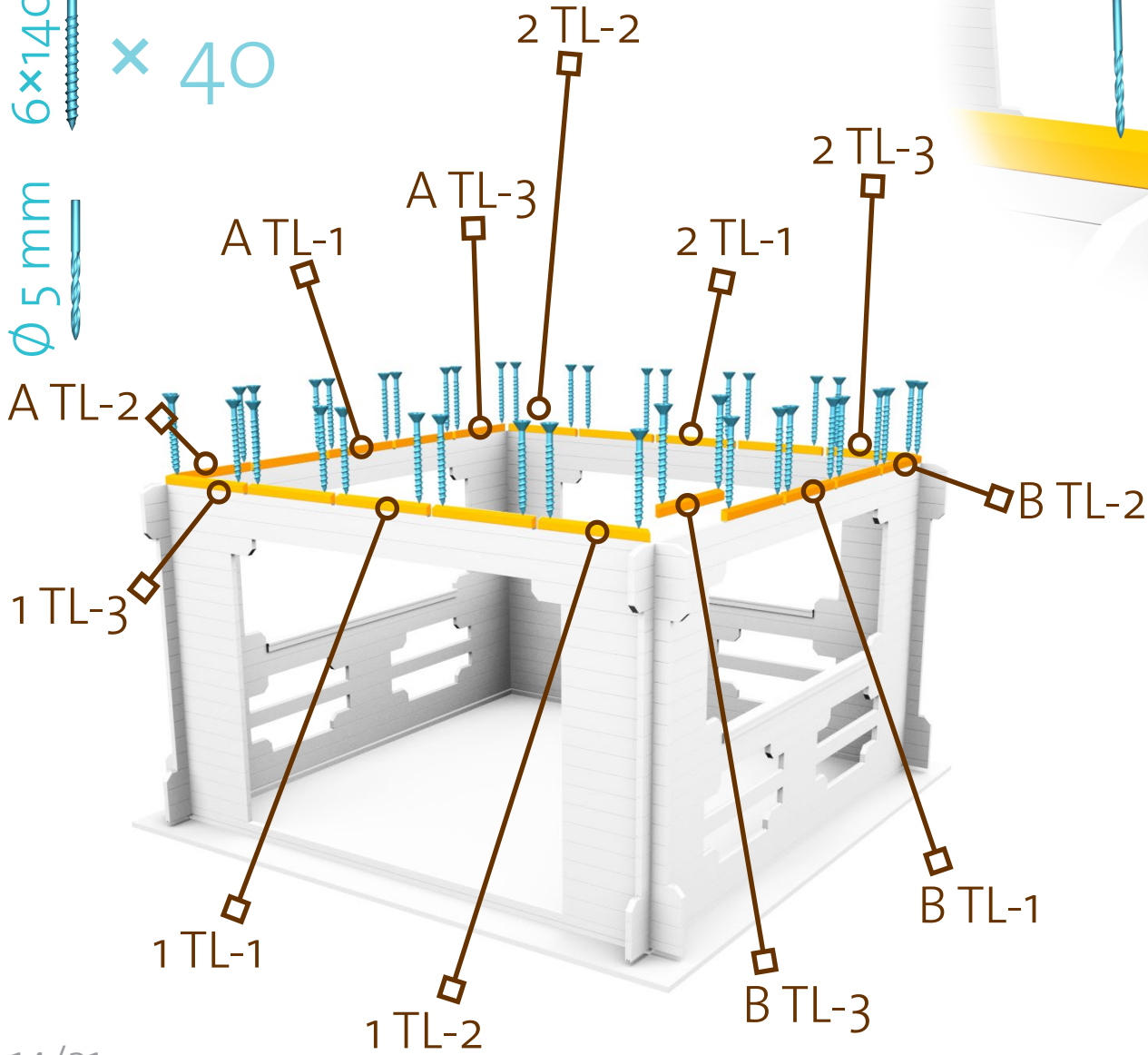

CONNECT THE ROOF PURLINS (RFR) WITH RD BEFORE INSTALLING THEM ON TOP OF THE CORNERS.

BERGEN 40

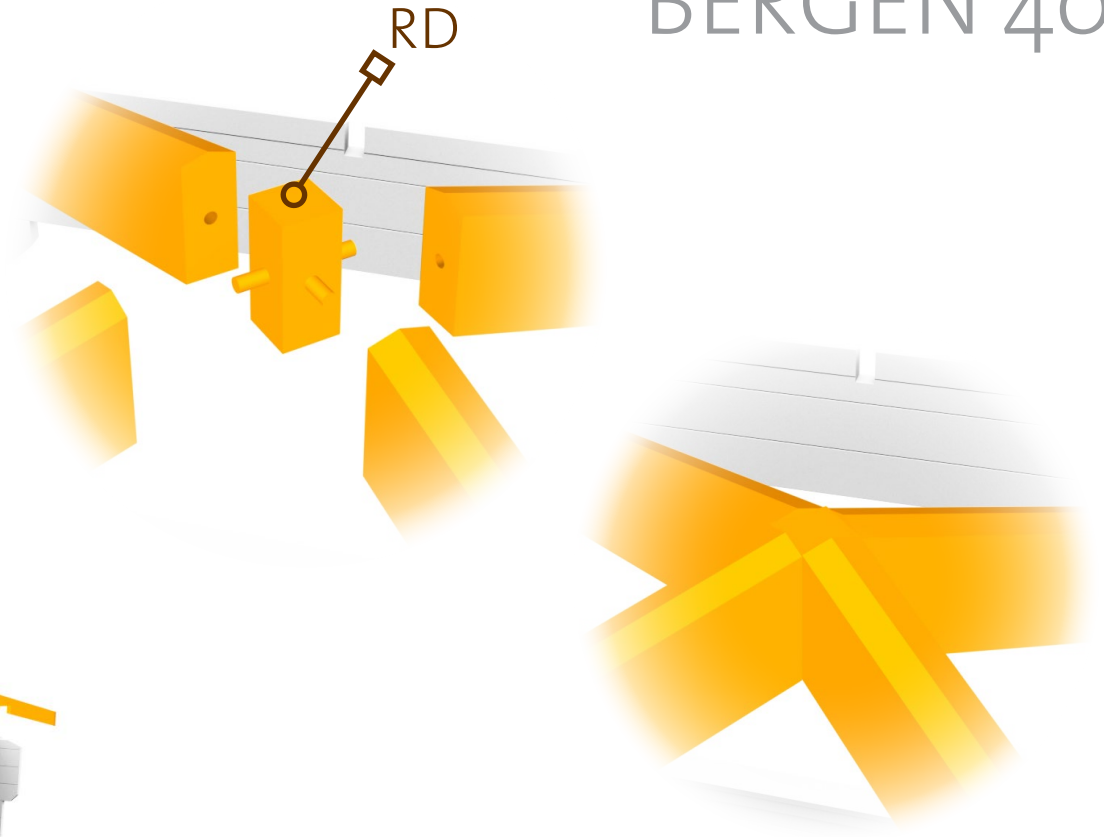
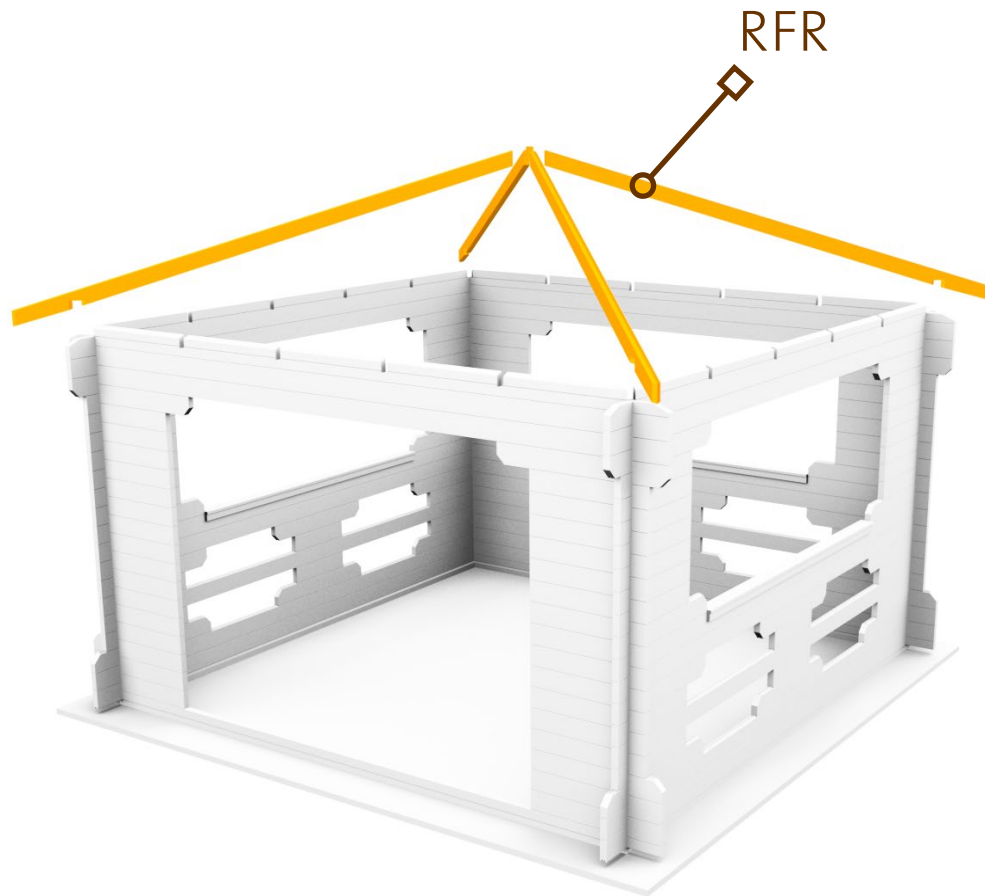



INSTALL THE **ROOF** PURLINS AND ATTACH THEM WITH SCREWS.

6x140 × 4  
Ø 5 mm

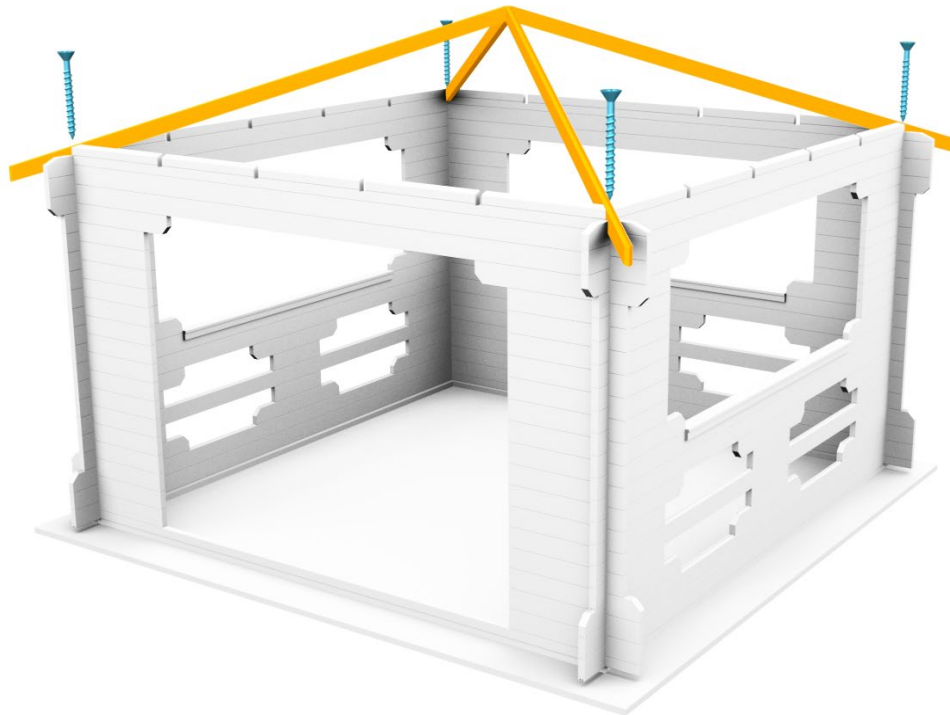

BERGEN 40

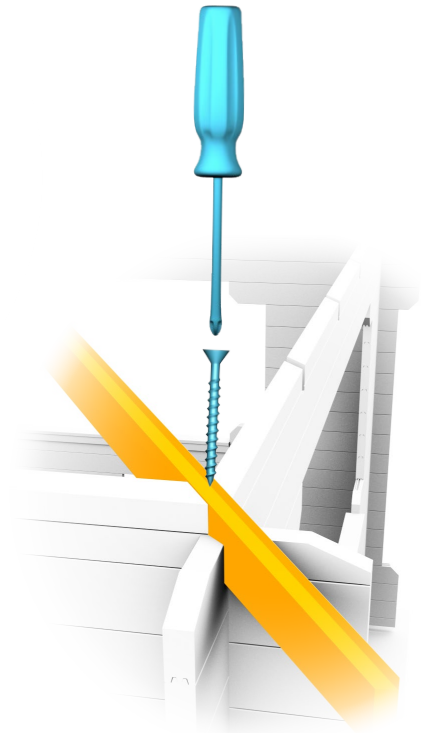



INSTALL THE **ROOF** PURLINS (RFB) AND ATTACH THEM WITH SCREWS.

BERGEN 40

$5 \times 70$   $\times 16$   $6 \times 140$   $\times 16$

$\Phi 4$  mm

$\Phi 5$  mm

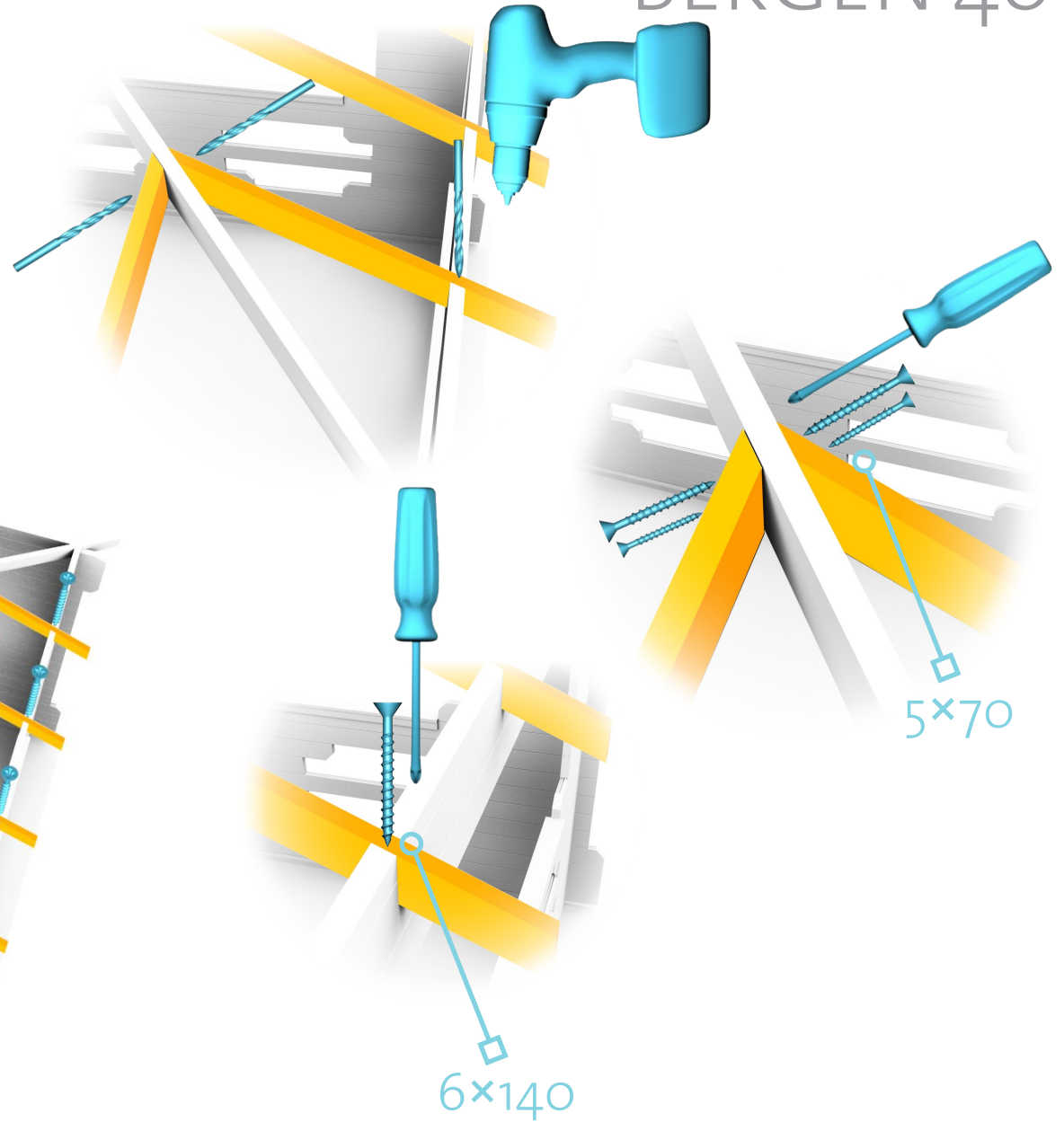
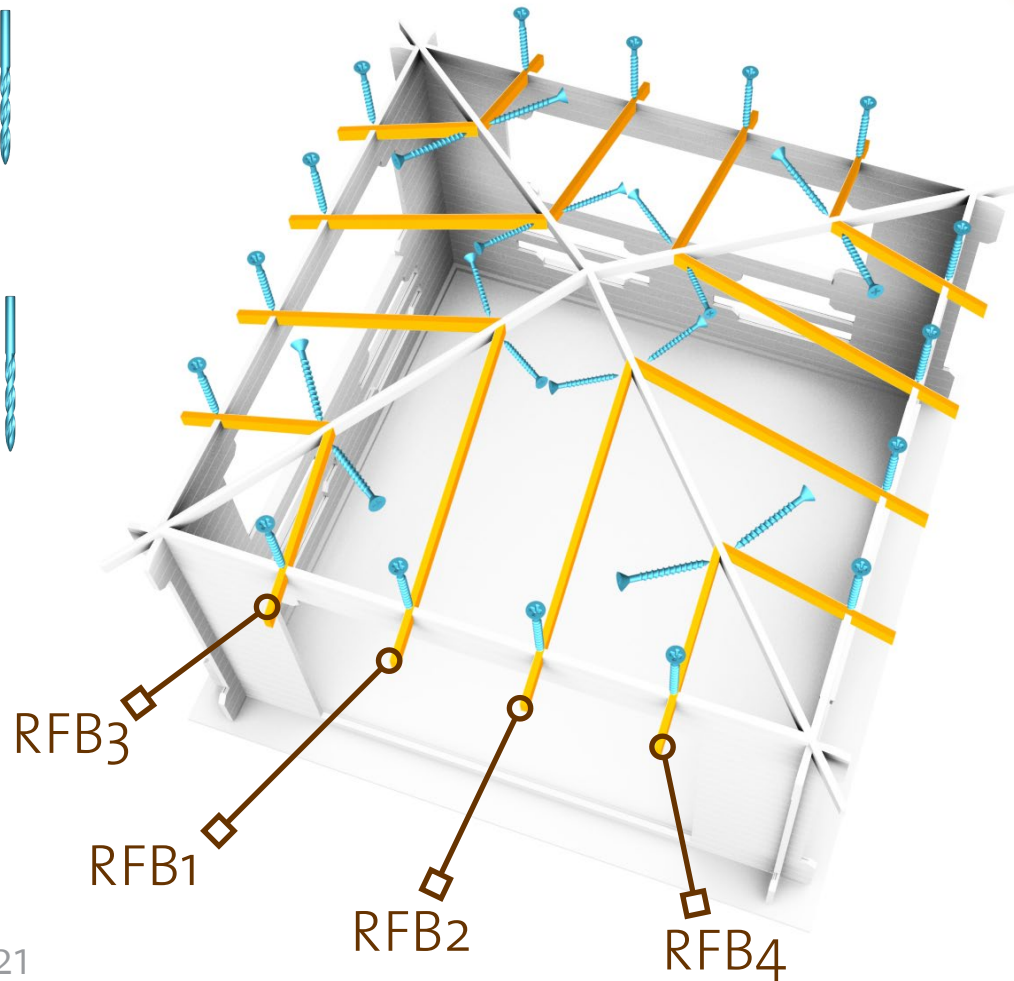

PLACE THE FIRST ROOFBOARD FLUSH WITH THE END OF THE PURLINS AND ATTACH WITH SCREWS

4x50 × 424



BERGEN 40

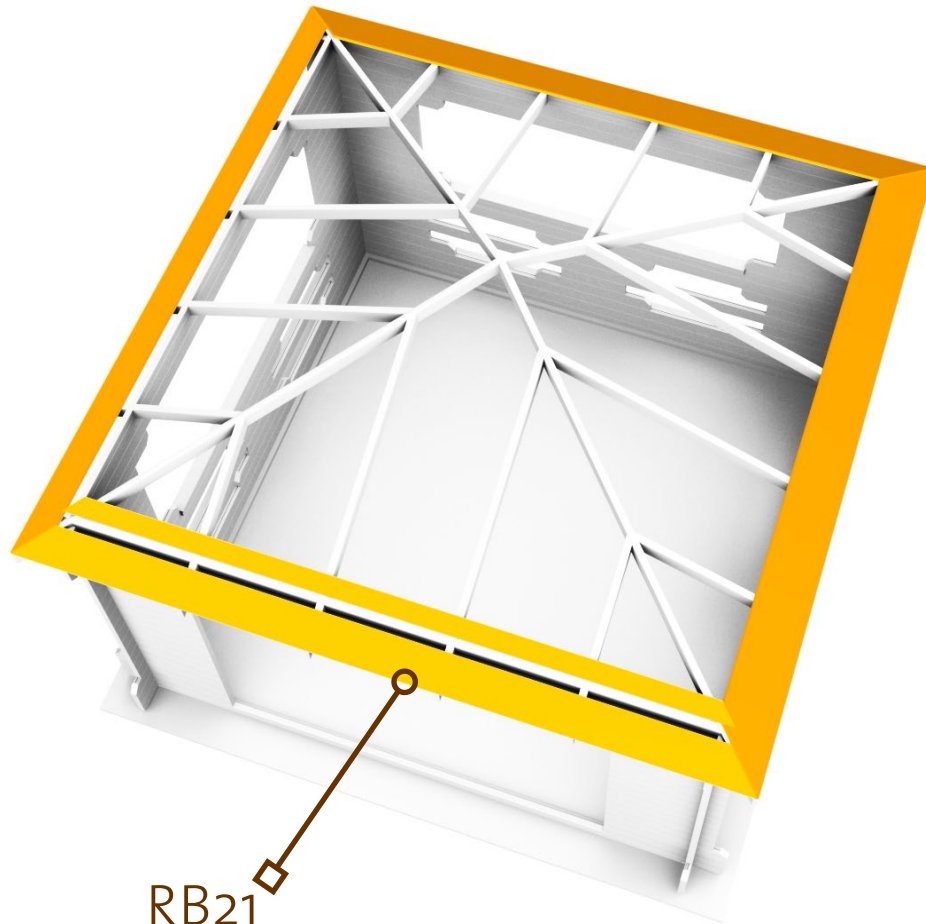
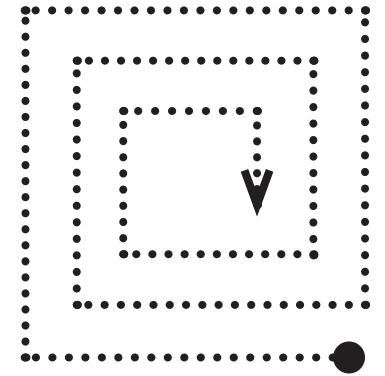

INSTALL THE ROOF TOP AND ATTACH IT WITH SCREWS. ATTACH FASCIA TRIMS INTO ROOFPURLINS.

BERGEN 40

4x40  
× 56

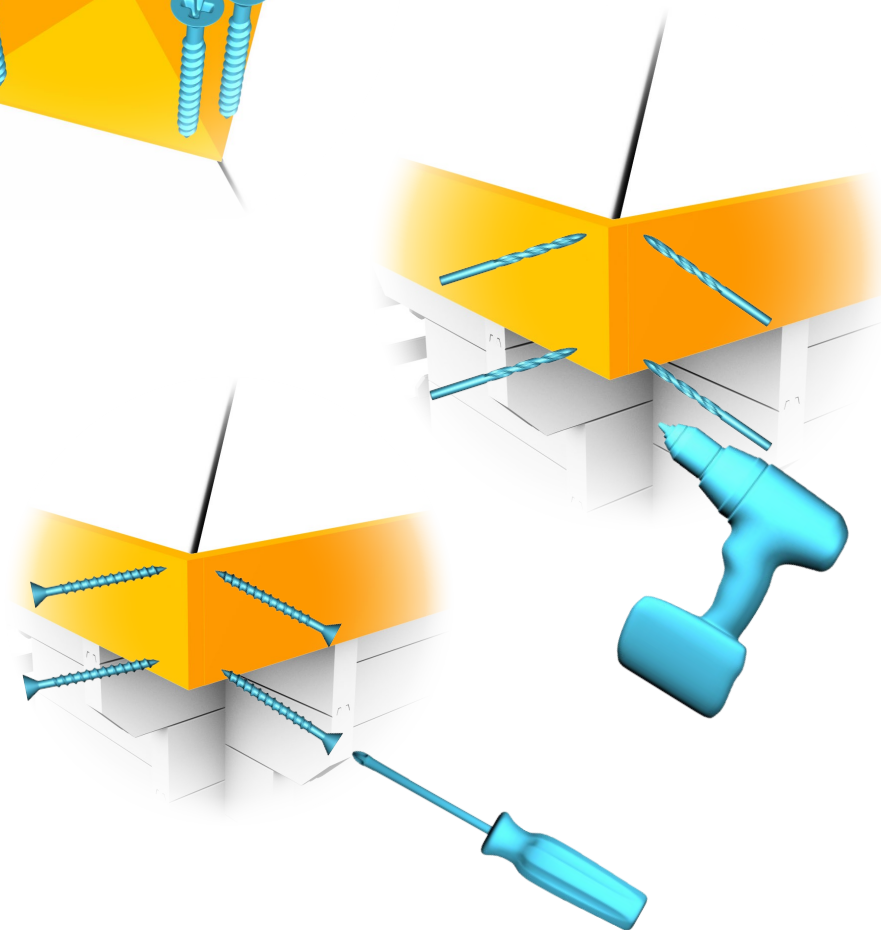
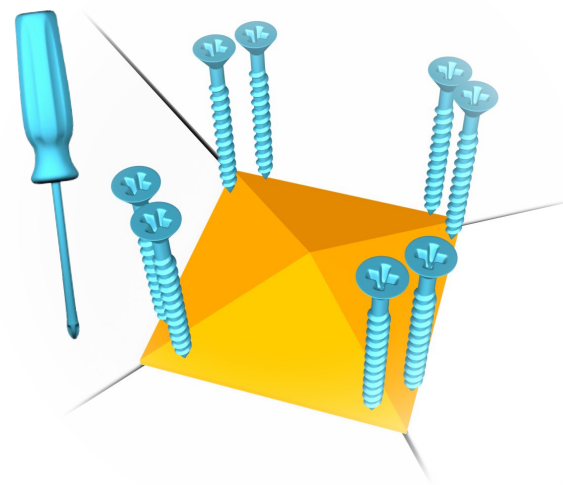
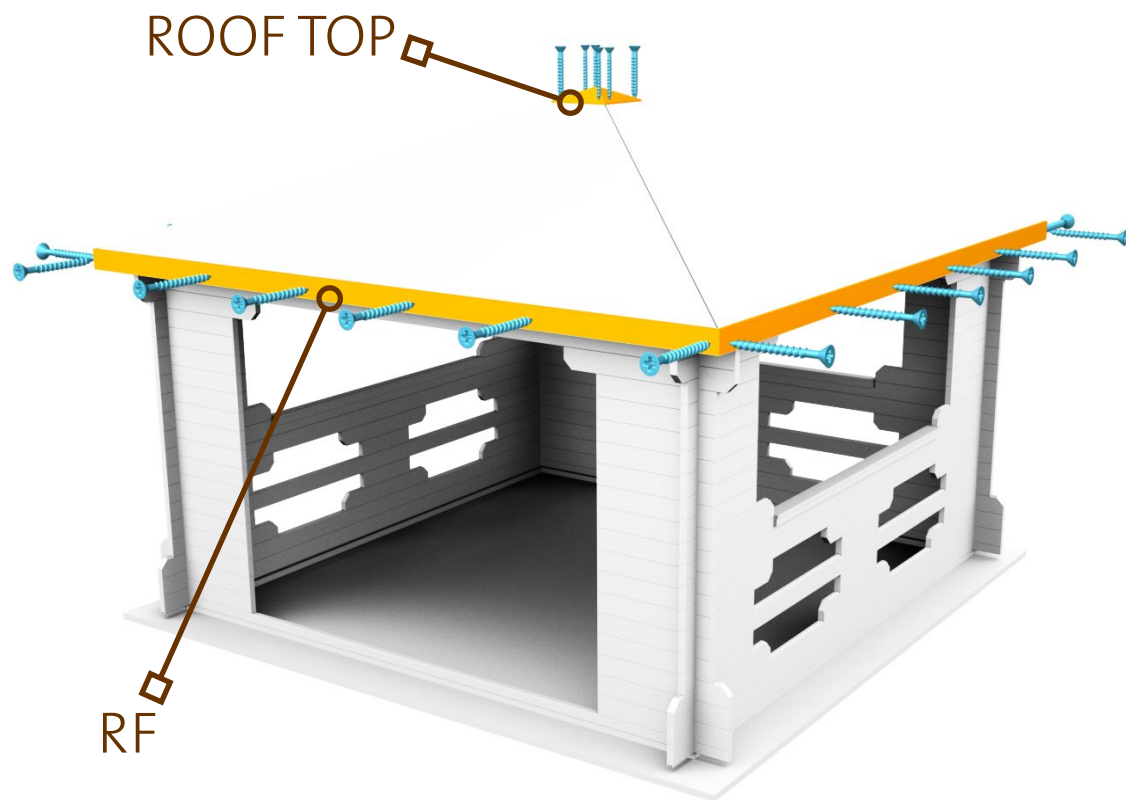

WINDBOARD CONNECTS BOTTOM LOG WITH THE TOP LOG. SAW THE WINDBOARD INTO THE RIGHT LENGTH. FOR THE TOP BOLT, DRILL 8MM HOLE THROUGH THE WINDBOARD.

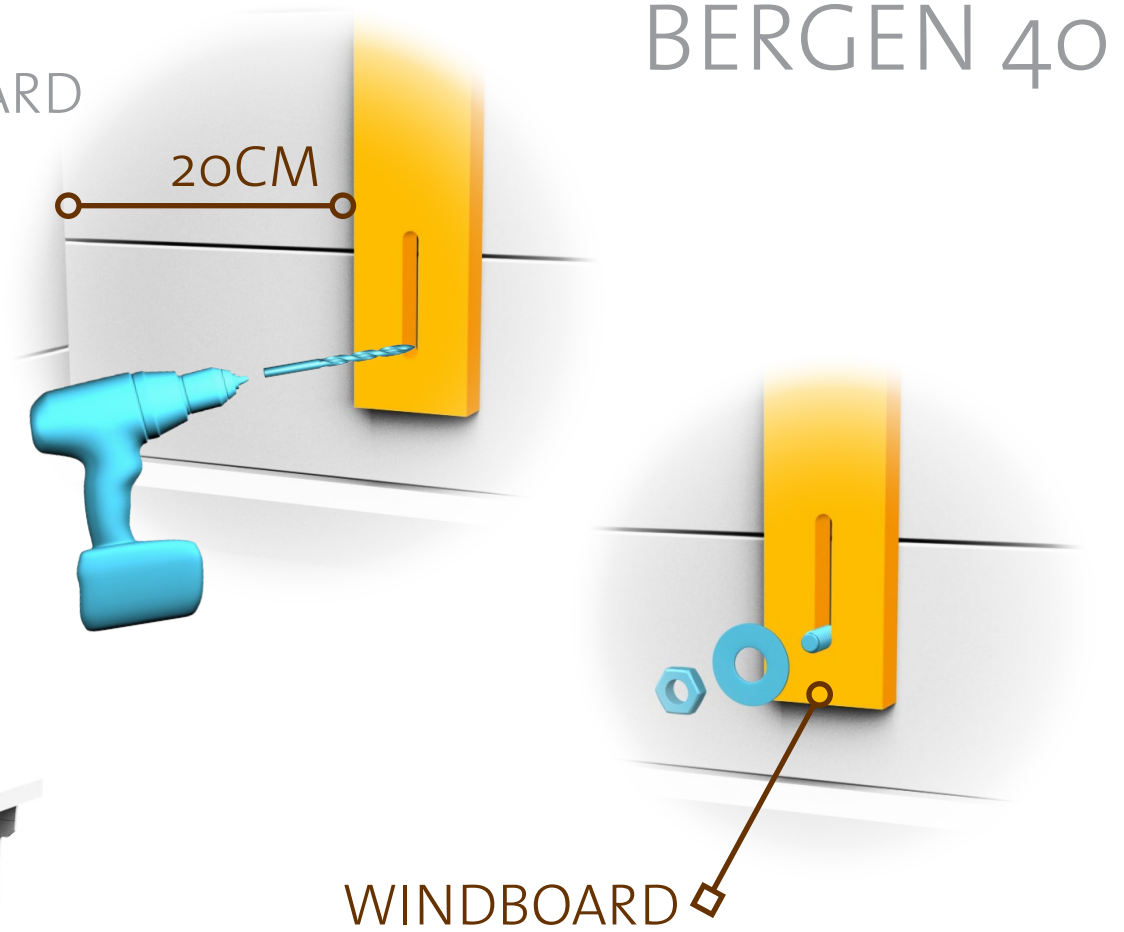
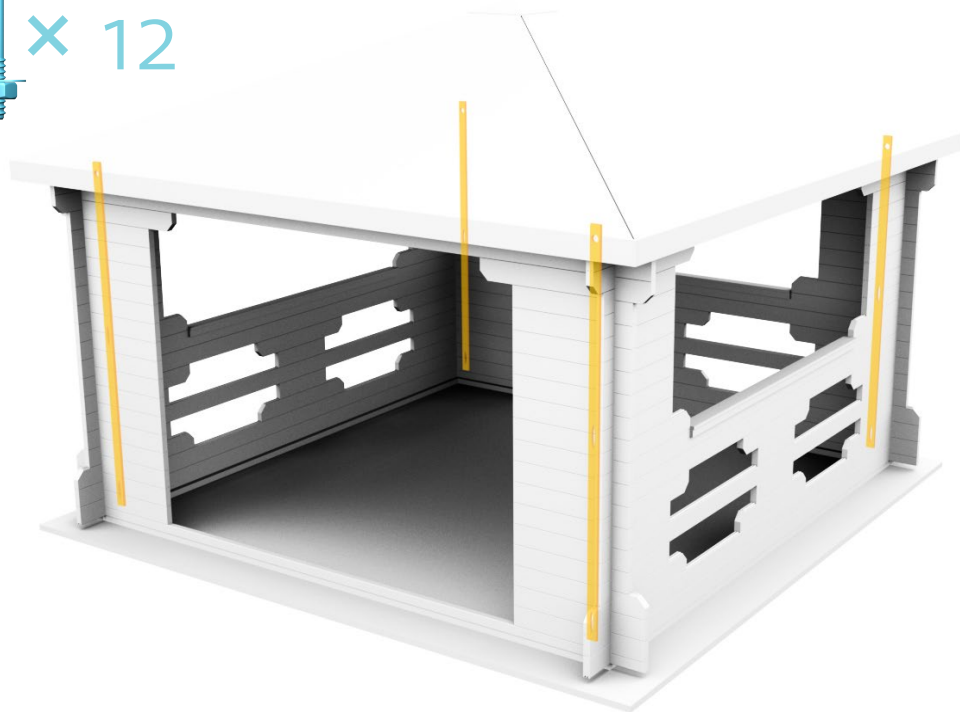
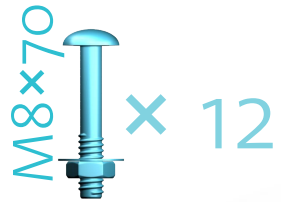
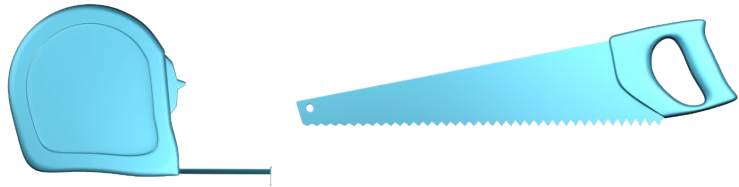

BERGEN 40

DRILL THROUGH THE WALL, HOLE MUST BE AT THE BOTTOM OF THE OVAL, ATTACH WITH BOLTS. 99%

WHEN THE HOUSE IS ASSEMBLED, YOU SHOULD COVER THE TIMBER WITH WOOD PROTECTIVE SEAL, PAINT OR STAIN AS SOON AS POSSIBLE TO AVOID DETERIORATION TO THE WOOD.

BERGEN 40

