

Installation manual

Montageanleitung • Notice de montage • Istruzioni per il montaggio • Manual de montaje • Monteringsanvisning •
Installatiegids • Montážní návod • Asennusohje • Installationsmanual • Paigaldusjuhend

Log cabin FR44-5540

Blockhaus • Maisonnette en poutres • Casa di travi • Casa de jardin • Anneks • Tuinhuis • Zahradní domek •
Timmerstuga • Hirsimökki • Freesprussmaja

Width 550 x Depth 400 cm







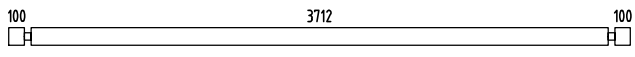
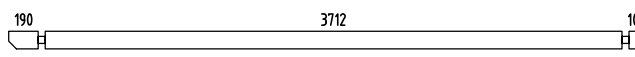
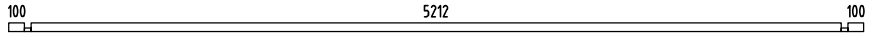
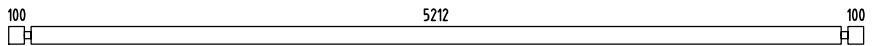
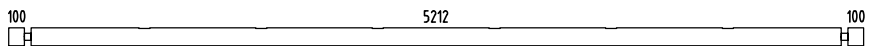
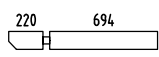
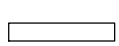
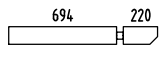
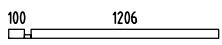
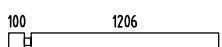
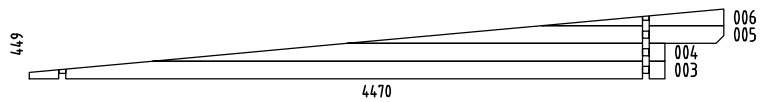
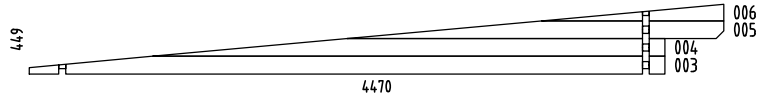
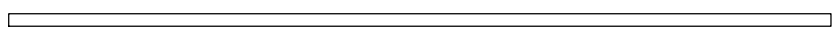
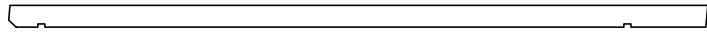

Breite/Tiefe • Largeur/Profondeur • Lunghezza/Profondità • Ancho/Profundidad • Bredde/Dybde • Breedte/Diepte
• Šířka/Hloubka • Leveys/Pituus • Bredd/Längd • Laidus/pikkus

Log thickness 44 mm







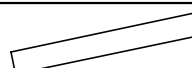

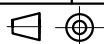







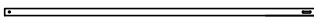

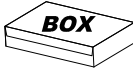
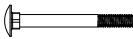
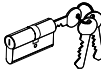

Bohlenstärke • Épaisseur des murs • Spessore delle pareti • Grosor de pared • Tykkelse • Wanddicke • Tloušťka
stěny • Seinän paksuus • Väggtjocklek • Seinapaksus

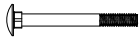





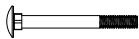
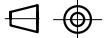

The producer shall have the right to make technical changes to the product • Technische Änderungen vorbehalten • Le
producteur réserve le droit d'effectuer des modifications techniques au produit • Il produttore mantiene il diritto di apportare
modifiche tecniche al prodotto • Reservado el derecho a modificaciones técnicas • Produsent forbeholder seg retten til å endre
tekniske egenskaper ved produktet • Alle rechten en technische wijzigingen voorbehouden • Výrobce si vyhrazuje právo na
technické změny výrobku • Valmistaja pidättää oikeuden tehdä tuotteeseen teknisiä muutoksia • Tillverkaren har rätt att utföra
tekniska förändringar för produkten • Tootja jätab endale õiguse muuta toote tehnilisi omadusi

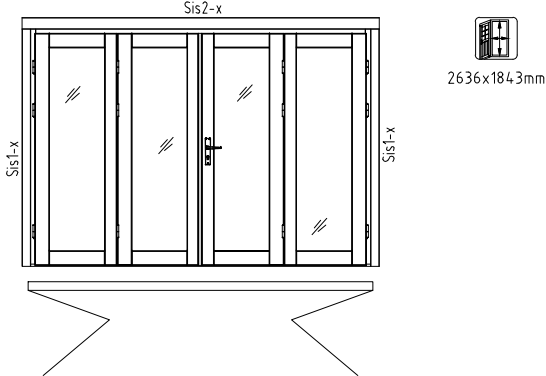
Pos	SPECIFICATION-STÜCKLISTE-NOMENCLATURE-ELEMENTI-ESPECIFICACIÓN FR44-5540	Pcs	Profile (mm)	Length (mm)
001		32	44x114	4000
002		2	44x114	4090
007		1	44x57	5500
008		16	44x114	5500
009		2	44x114	5500
010		2	44x114	958
011		10	44x114	681
012		2	44x114	958
013		2	44x57	1350
014		34	44x114	1350
W1-1		1		
W2-1		1		
AR1	Foundation- Fundament- Fondation- Fondazione- Vigas de cimentación 	8	60x80	5290
RoR2	Rafter- Sparre- Chevron- Trave- Cabrio 	6	70x140	4497
RoR1	Rafter- Sparre- Chevron- Trave- Cabrio 	6	44x140	220
FB2-1	Floor board- Fussbodenbrett- Madrier du plancher - Tavola pavimento- Tabla de suelo 	59	89x19	3707
RB2-1	Roof board- Dachbrett- Madrier du toit- Tavola tetto- Tabla de tejado 	51	89x19	4000
RB2-2	Roof board- Dachbrett- Madrier du toit- Tavola tetto- Tabla de tejado 	51	89x19	1740
EaE6-1	Eave edging- Dachrandbrett- Madrier en bordure du toit- Tavola bordo tetto- Tabla de valadizo 	1	19x120	2520
EaE6-2	Eave edging- Dachrandbrett- Madrier en bordure du toit- Tavola bordo tetto- Tabla de valadizo 	1	19x120	3260
EaE5-1	Eave edging- Dachrandbrett- Madrier en bordure du toit- Tavola bordo tetto- Tabla de valadizo 	2	19x95	2520
EaE5-2	Eave edging- Dachrandbrett- Madrier en bordure du toit- Tavola bordo tetto- Tabla de valadizo 	2	19x95	3260
FaB6-1	Facia board- Giebelblende- Écran frontal- Schermo frontone- Tabla de facia 	4	19x95	4505



Pos	SPECIFICATION-STÜCKLISTE-NOMENCLATURE-ELEMENTI-ESPECIFICACIÓN FR44-5540	Pcs	Profile (mm)	Length (mm)	
FIB2-1	Floor beading- Fussbodenleiste- Baguette du plancher- Llistello pavimento- Listón de suelo		7	19x19	2606
RE2-1	Roof edge reinforcement- Dachrandleiste- Baguette en bordure du toit- Rinforzo bordo tetto- Refuerzo borde tejado		2	32x40	3720
Sis1-1	Side slat- Randleiste- Baguette en bordure- Llistón de borde- Llistello bordo		4	19x70	1917
Sis2-1	Side slat- Randleiste- Baguette en bordure- Llistón de borde- Llistello bordo		2	19x95	2892
Sla11-1	Slat- Leiste- Baguette- Llistello- Listón		1	19x58	2800
StB1-1	Storm brace- Sturmleiste- Protection contre le vent- Antivento- Protector contra tormentas		2	25x45	1900
StB1-2	Storm brace- Sturmleiste- Protection contre le vent- Antivento- Protector contra tormentas		2	25x45	2250
WG1-1	Water gutter- Wasserleiste- Rejet d'eau- Protección de lluvia- Protezione dalla pioggia		1	19x33	3100
Fim	-Fixing kit- Befestigungsset- Moyens de fixation- Materiale di fissaggio- Kit de fijación		1	USE	
QPOYP8x80Zn	Bolt -Schloss-schraube -Boulon- Bullone- Perno- M8x80mm PUP0		8	StB1-x	
QULSI30x35	Cylinder- Zylinderschloss- Serrure a mortaiser- Serratura a cilindro- Bombin- 30.35		1	TU44-90P	
QLIU KAPal	Door fittings- Türbeschlag- Ferrure- Ferramenta porta- Manilla puerta- QLIUKAPal		1	TU44-90P	
QNA1 4x40Me	Nail- Nagel- Clou- Chiodo- Clavo- 1.4x40mm		50	FIB2-1	
QNA2 2x50Zn	Nail- Nagel- Clou- Chiodo- Clavo- 2.5x50mm		1100	FB2-1; RB2-x	
QMUKK8Zn	Nut- Schraubenmutter- Écrou- Dado- Tuerca- M8mm		8		
QKRPP3 5x40Zn	Screw- Schraube- Vis- Vite- Tornillo- 3.5x40mm		170	EaEx-x; FaB6-1; RE2-1; ...	
QKRPP4 5x50Zn	Screw- Schraube- Vis- Vite- Tornillo- 4.5x50mm		40	TU44-90P	
QKRPP4 5x70Zn	Screw- Schraube- Vis- Vite- Tornillo- 4.5x70mm		60	007; 013; W1-1; W2-1 WG1-1	
QKRPP5x90Zn	Screw- Schraube- Vis- Vite- Tornillo- 5x90mm		38	TU44-90P (8) 010; 011; 012	
QKRPP6x120Zn	Screw- Schraube- Vis- Vite- Tornillo- 6x120mm		12	RoR1+Wall	
QKRPP6x180Zn	Screw- Schraube- Vis- Vite- Tornillo- 6x180mm		12	RoR2	
QSE8x22Zn	Washer- Dichtscheibe- Joint- Rondella- Arandela- 8x22mm		8		
	Object name FRB44-5540			Page 2/3	

Pos	SPECIFICATION-STÜCKLISTE-NOMENCLATURE-ELEMENTI-ESPECIFICACIÓN FR44-5540	Pcs	Profile (mm)	Length (mm)
TU44-90 P	Door - Tür - Porte - Porta-Puerta 2790x1936 	1		
QHA150Z n	Hook- Haken- Crochet- Ganzio- Pestillo QHA150Zn 	2	TU44-90P +WALL	
QT110x12 -1	Seal- Dichtung- Joint d'isolation- Guarnizione- Burlete- QT110x12 	1		25000
QT15_5x 9VA-1	Seal- Gummidichtung- Joint d'isolation- Guarnizione- Burlete- QT15_5x9VA 	1		4100
QNU20 x20x40	L-iron- Winkel- Angle -Angolo- Angulo 20x20x40 	2	WALL B Pos.008	
QKRYP5 x40ZnTX	Screw- Schraube- Vis- Vite- Tornillo- 5x40mm 	4		



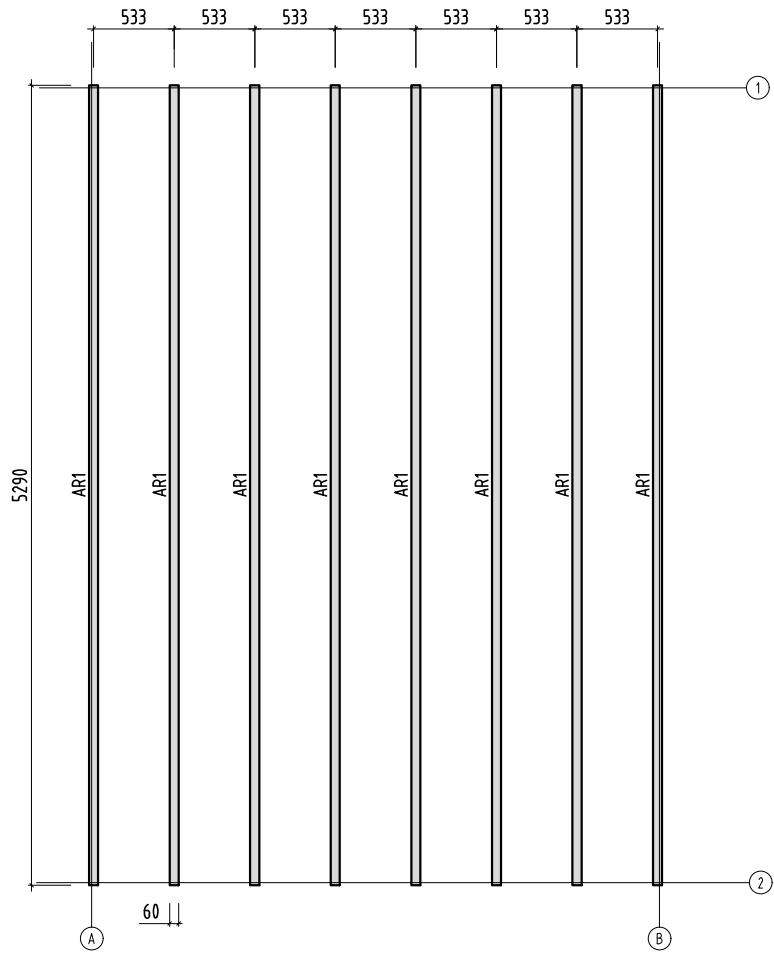

H = 1.500 m
TOTAL: 19.35 m²

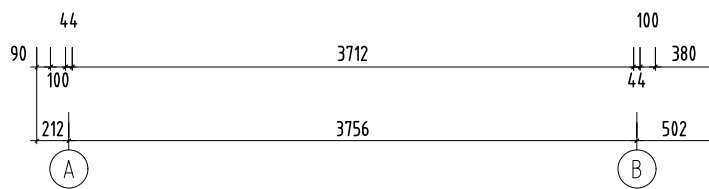
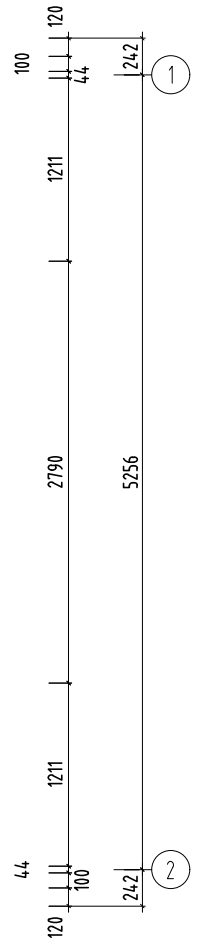
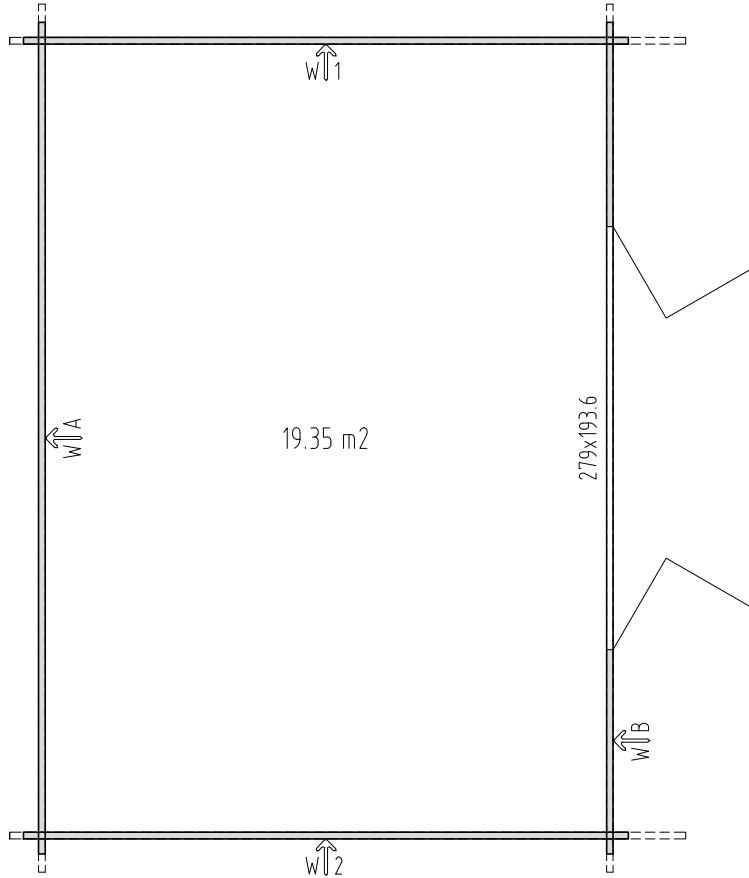
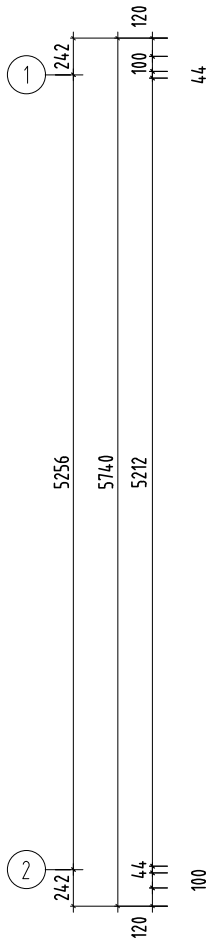
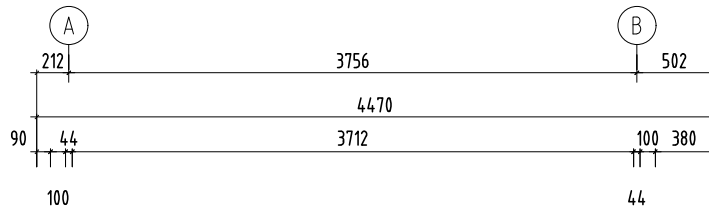

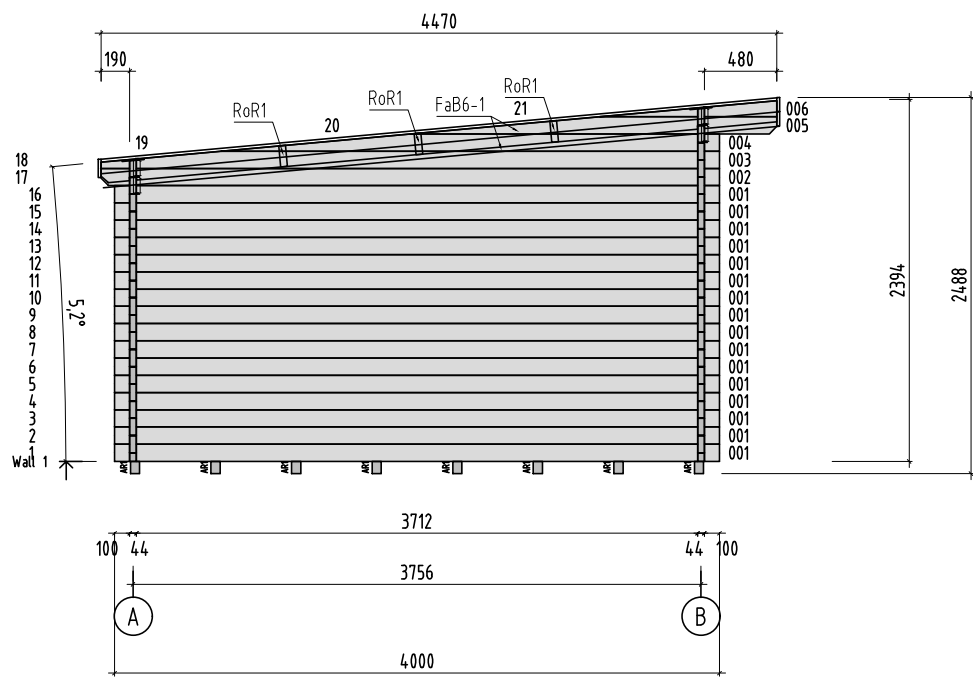
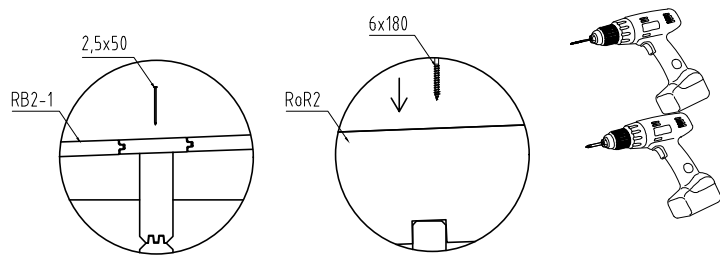

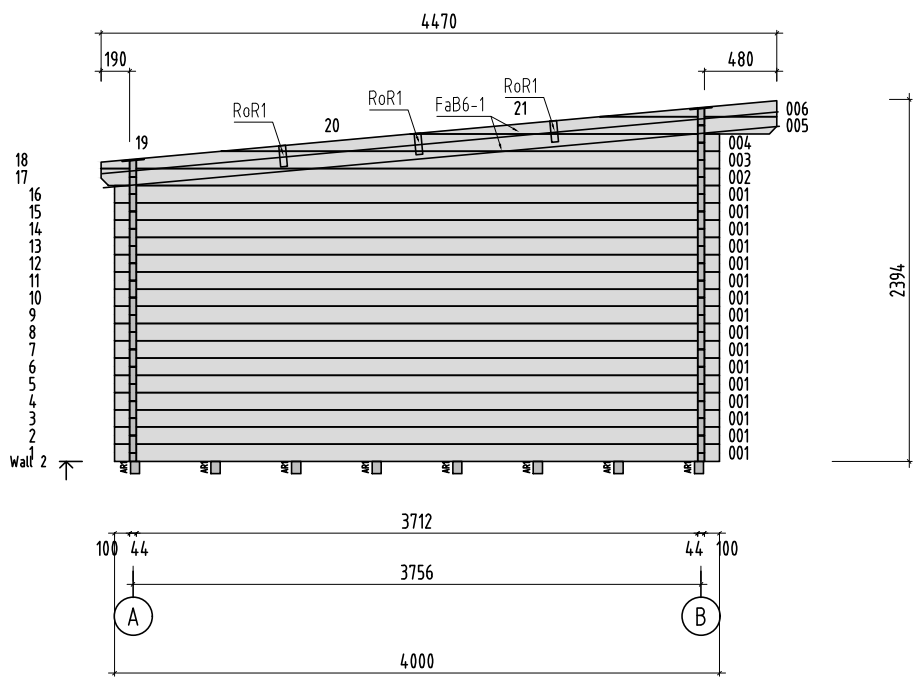

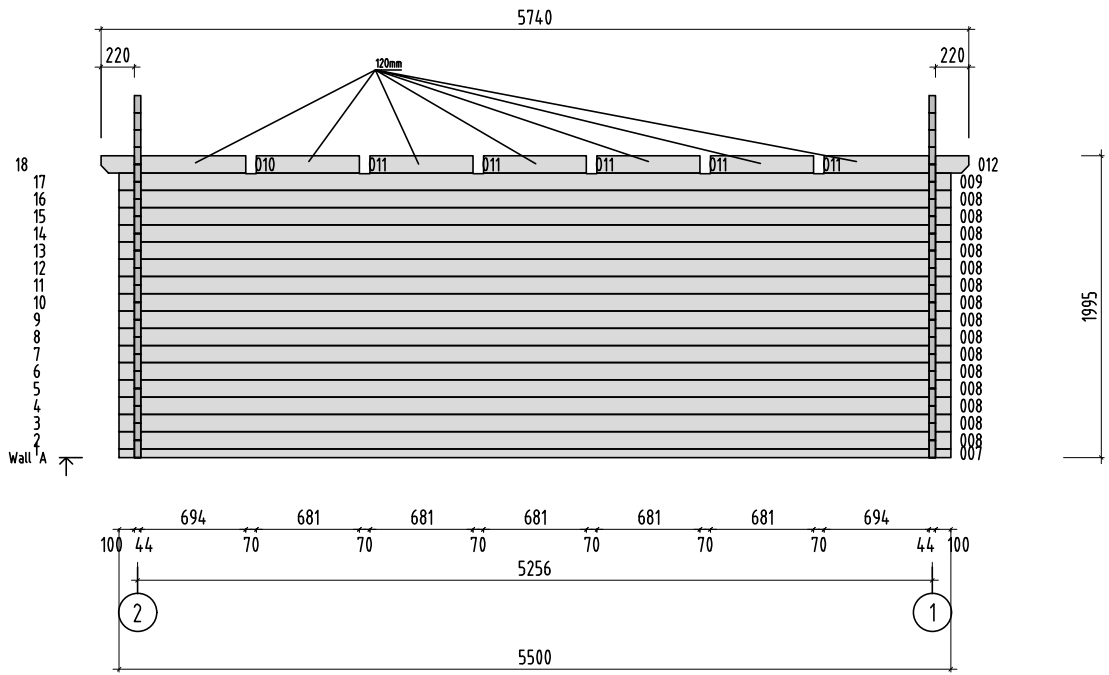
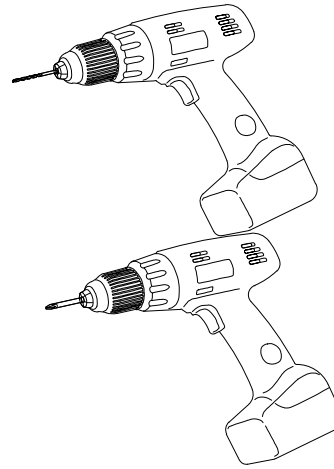
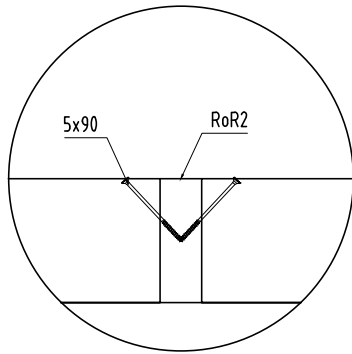

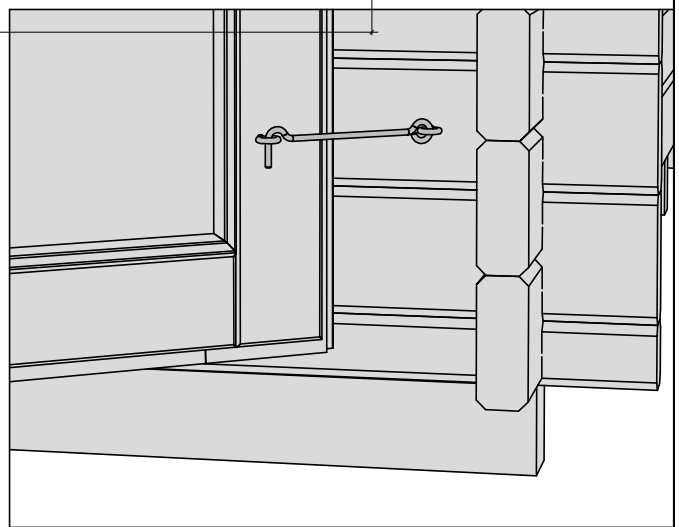
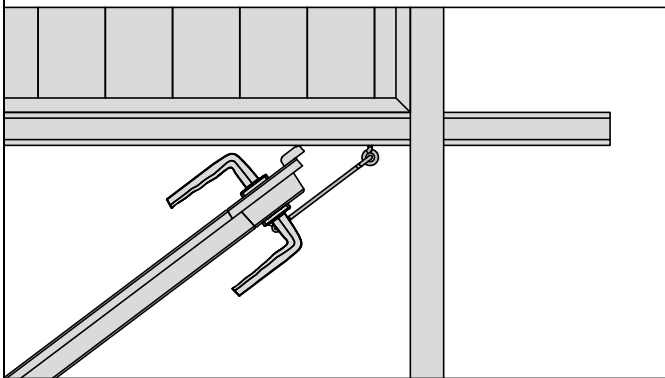
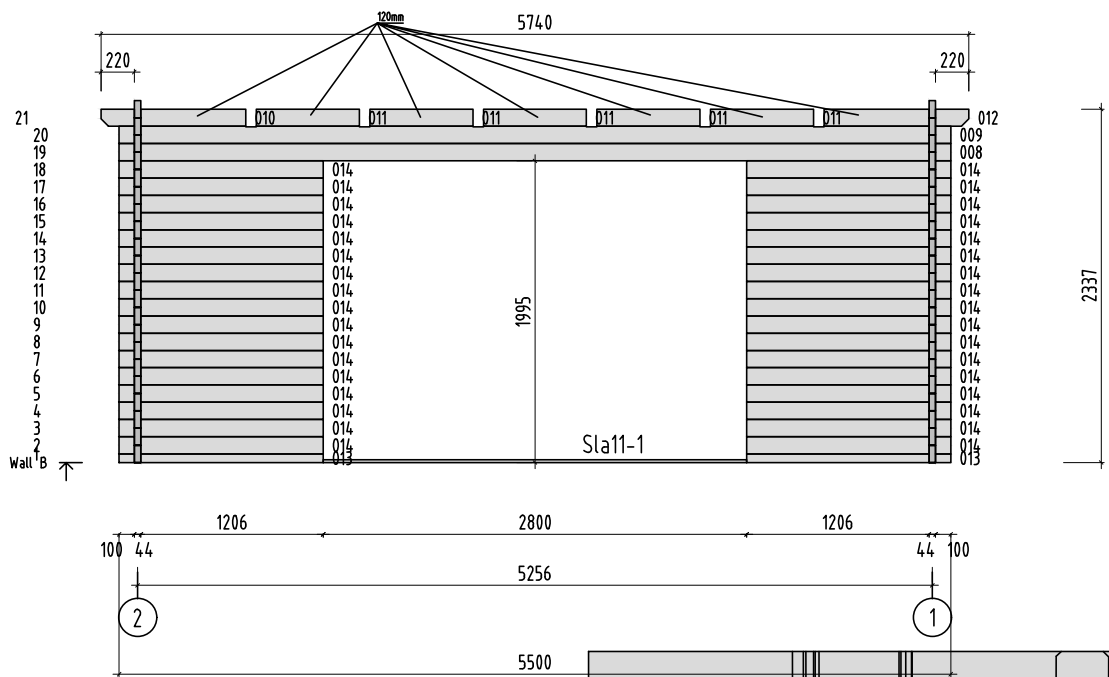

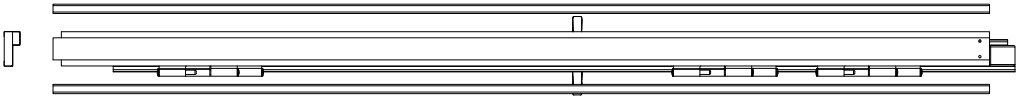
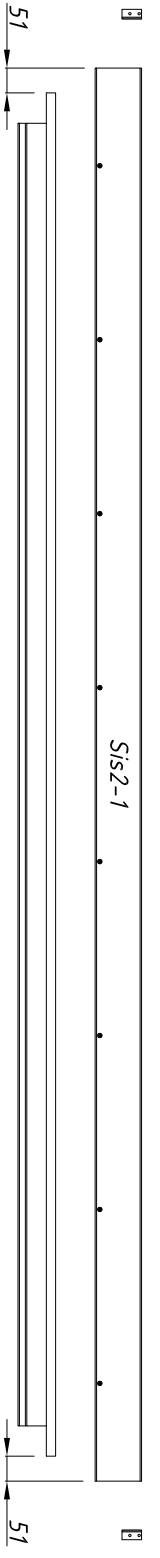
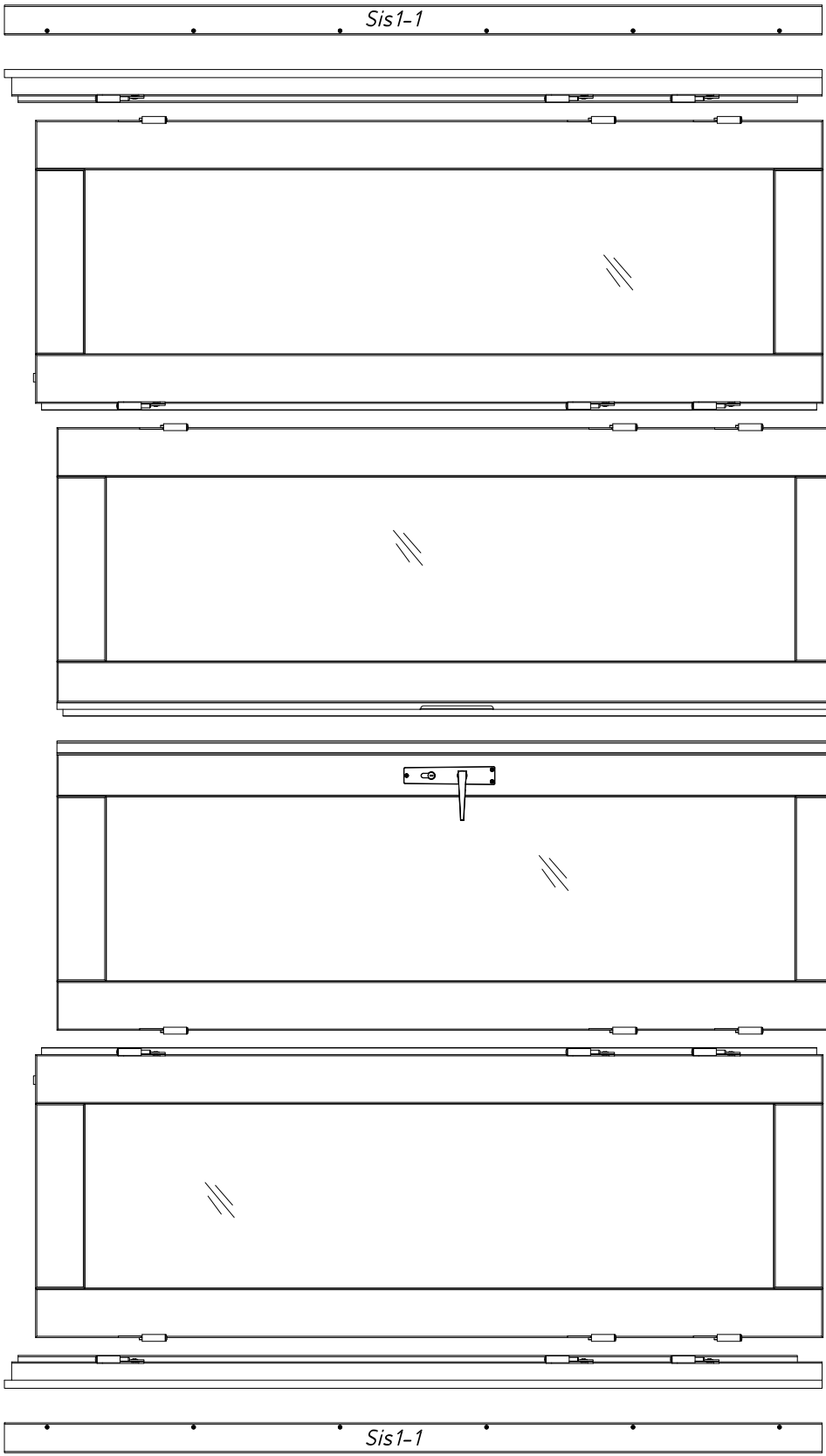
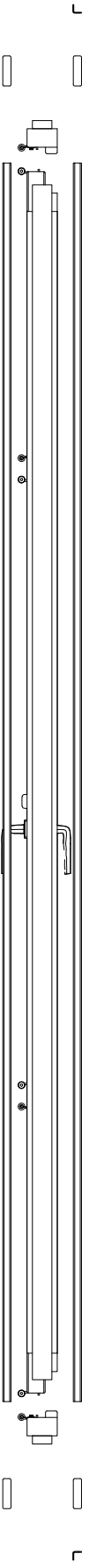

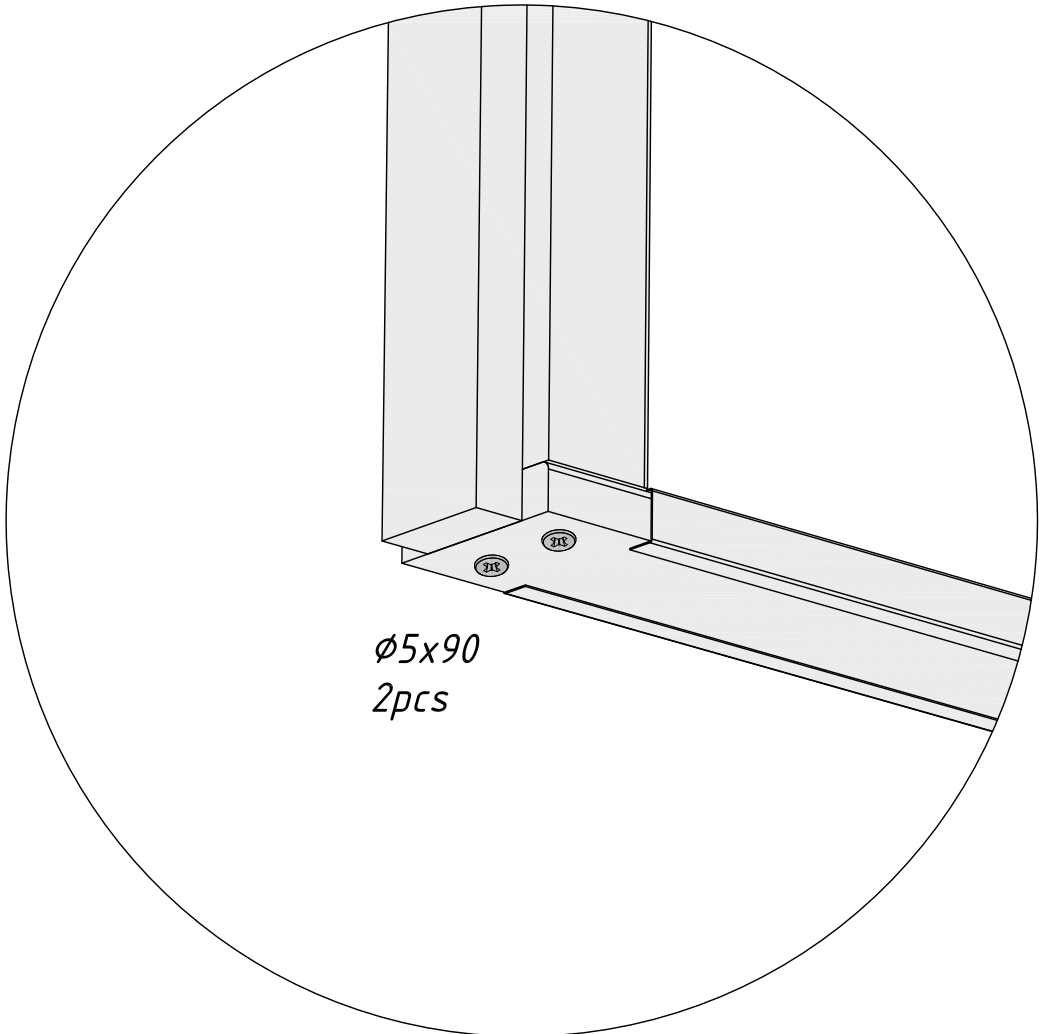
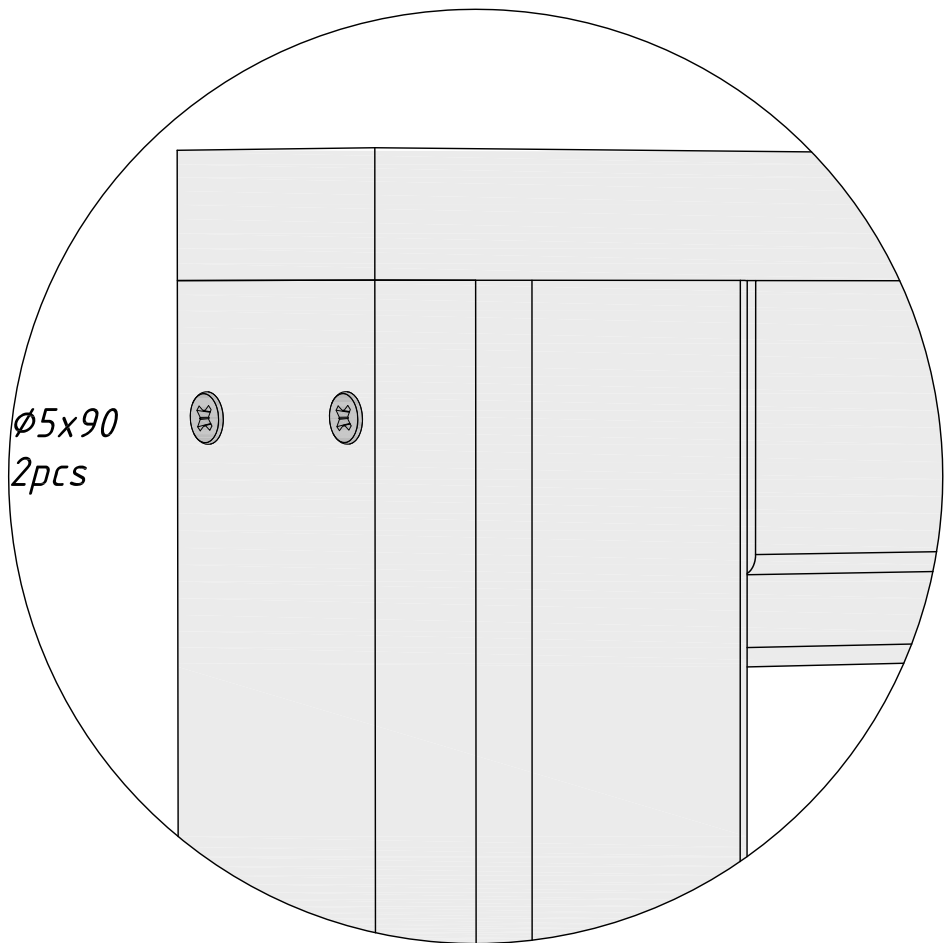

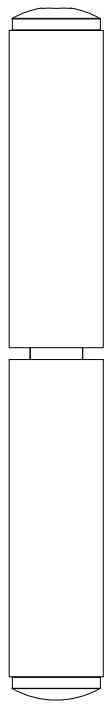
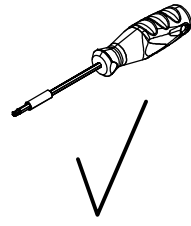
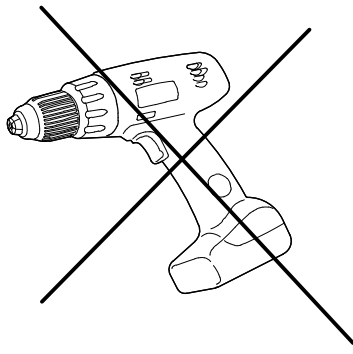

1.

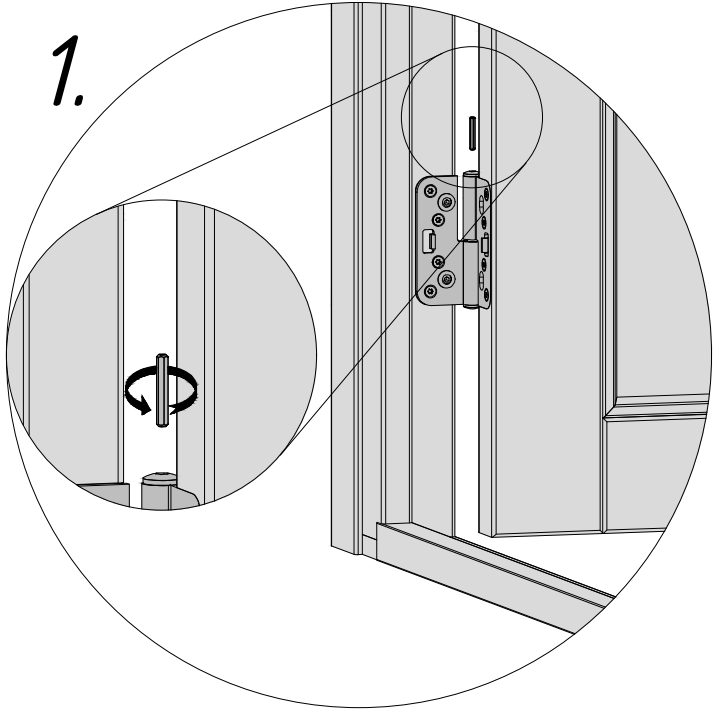

2.

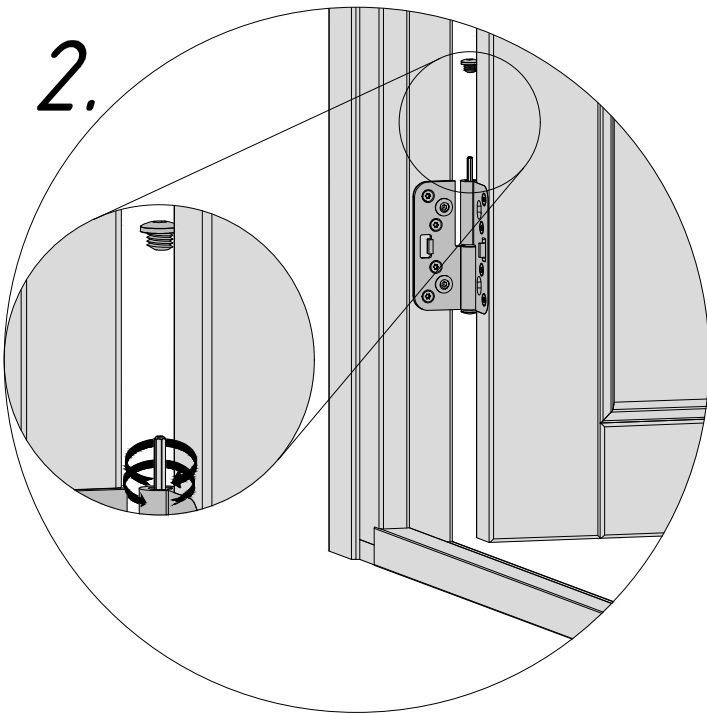

3.

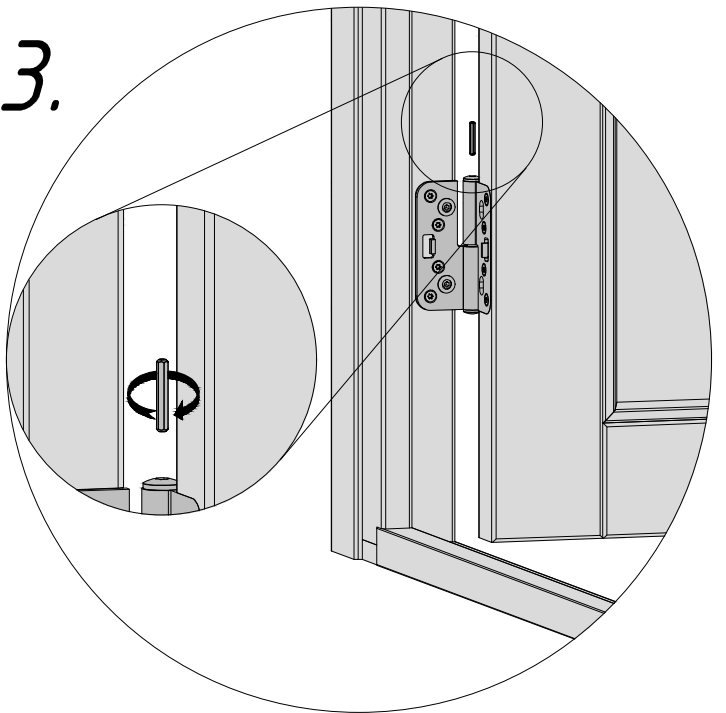

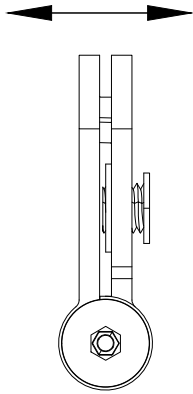
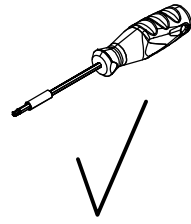
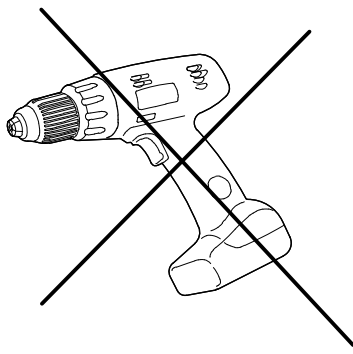

1.

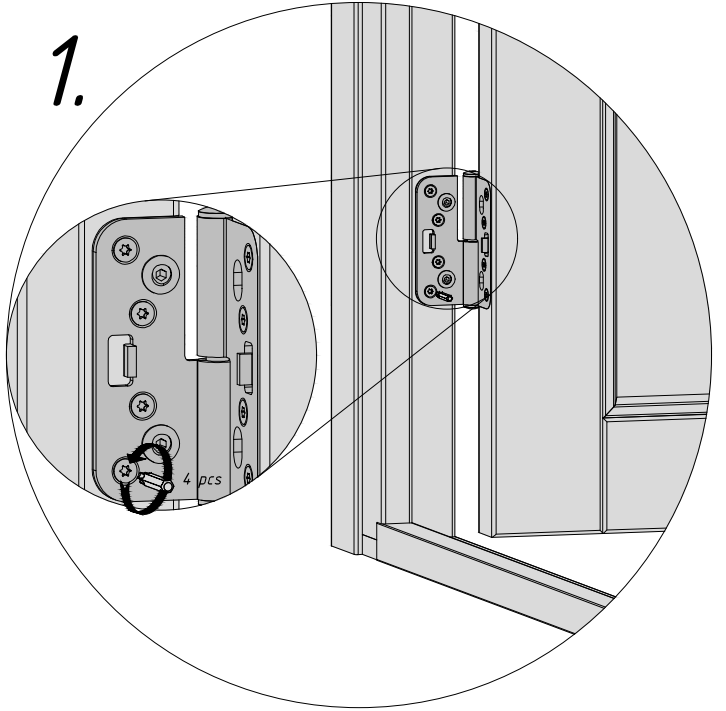

2.

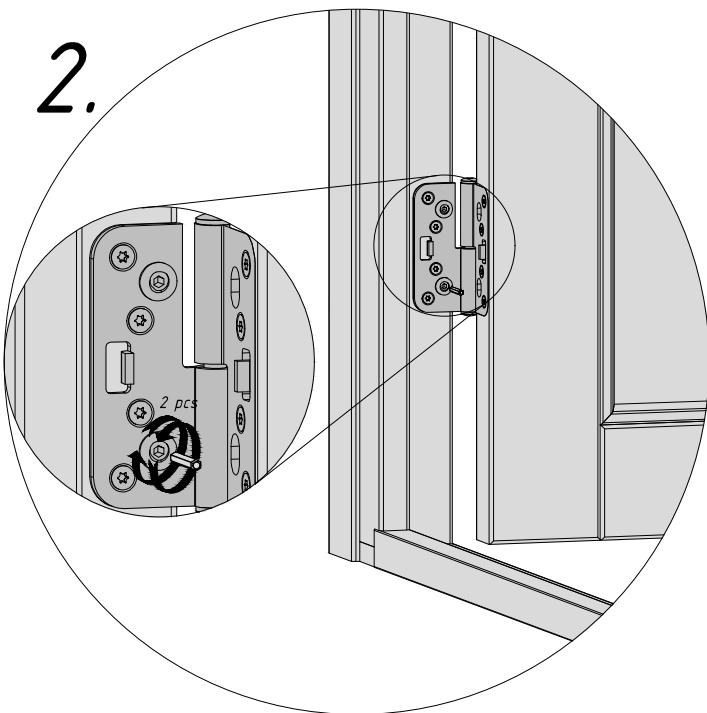

3.

