

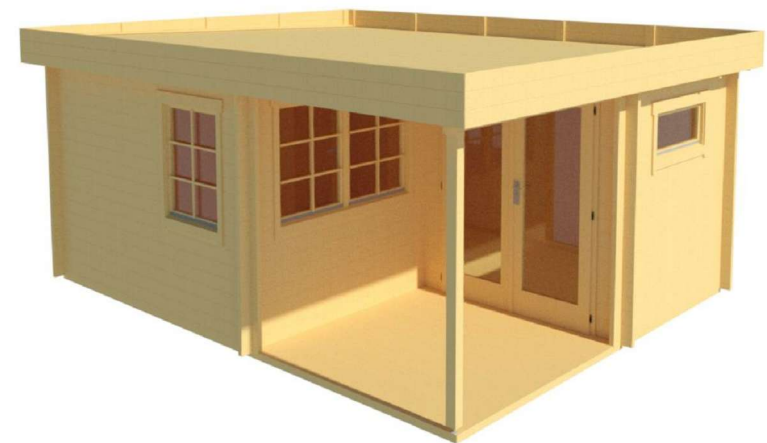

# Indigo 40 (480x380)

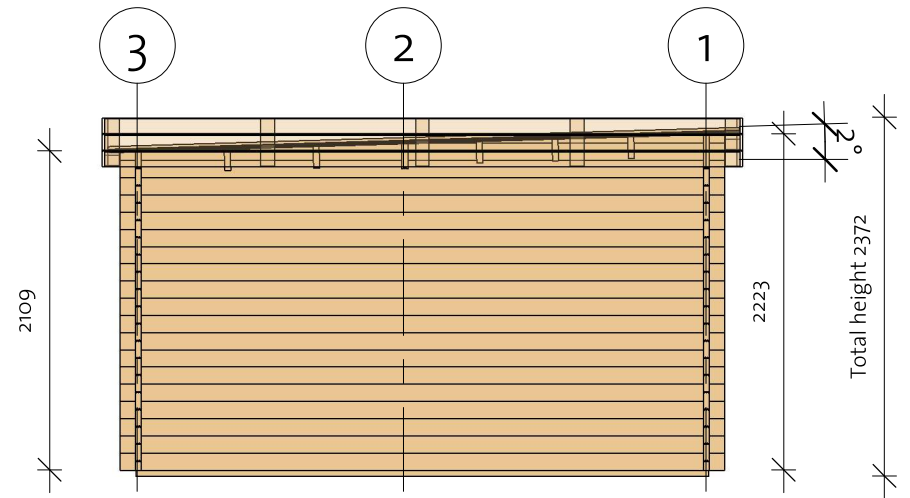
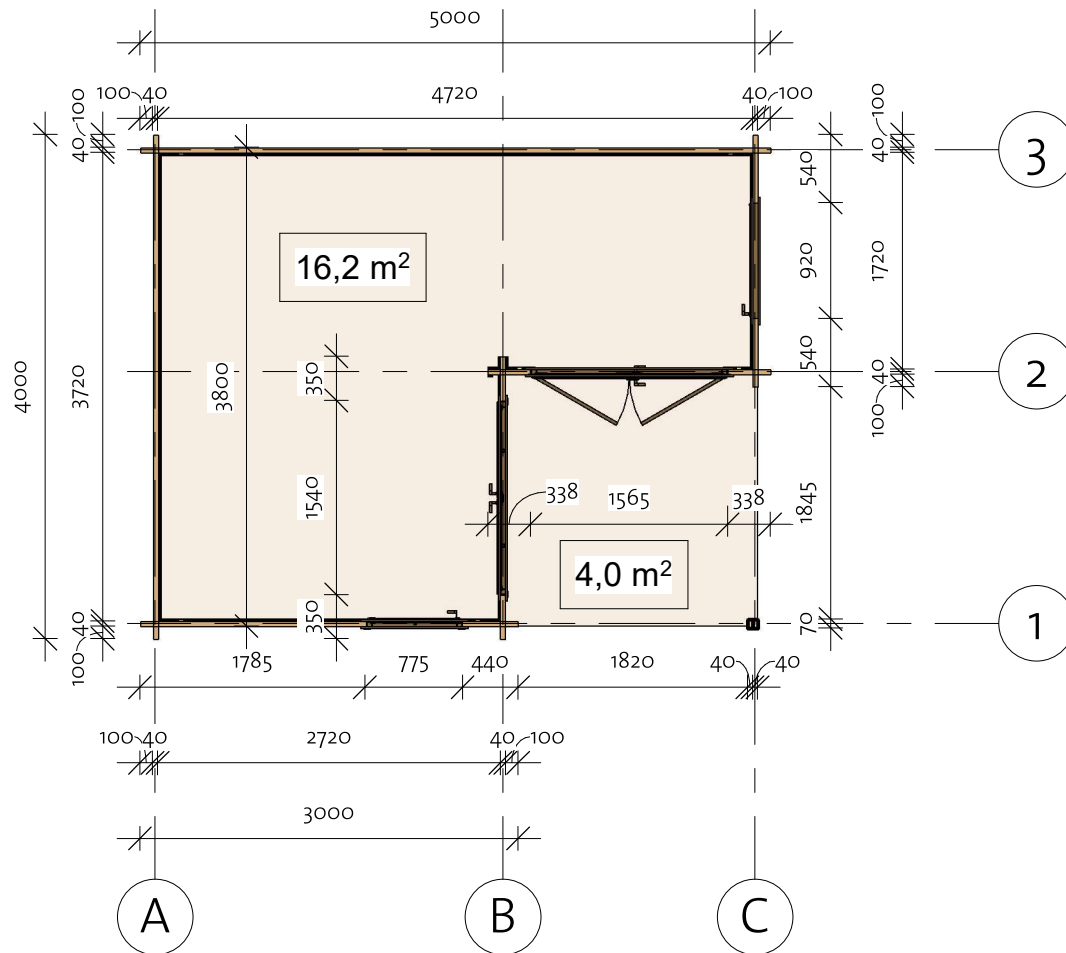
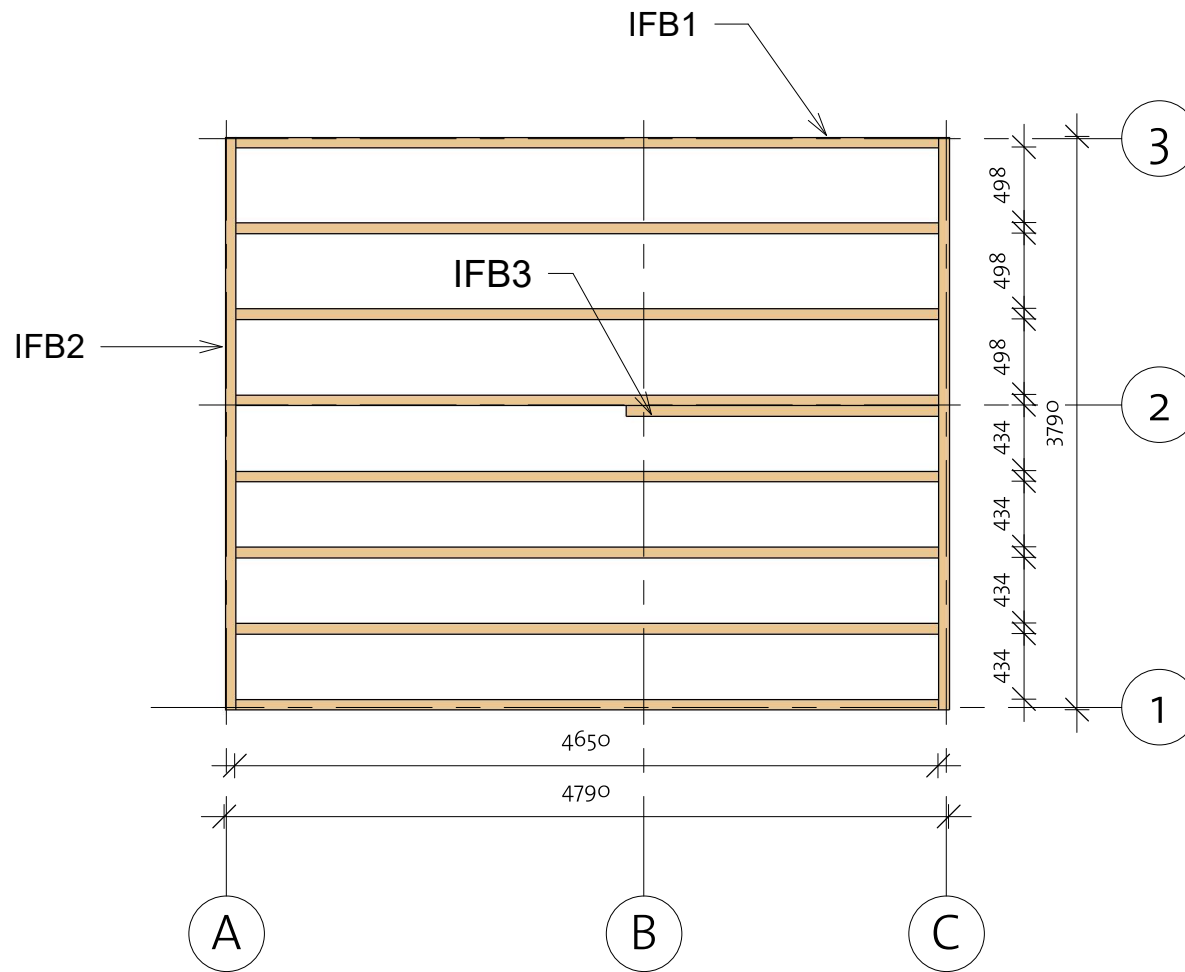

# Indigo 40 (480x380)

Foundation



Impregnated foundation beams				
Mark	Type	Profile	Count	Length
IFB1	IFB 70x40		8	4650
IFB2	IFB 70x40		2	3790
IFB3	IFB 70x40		1	2065



# Indigo 40 (480x380)

Floor Plan

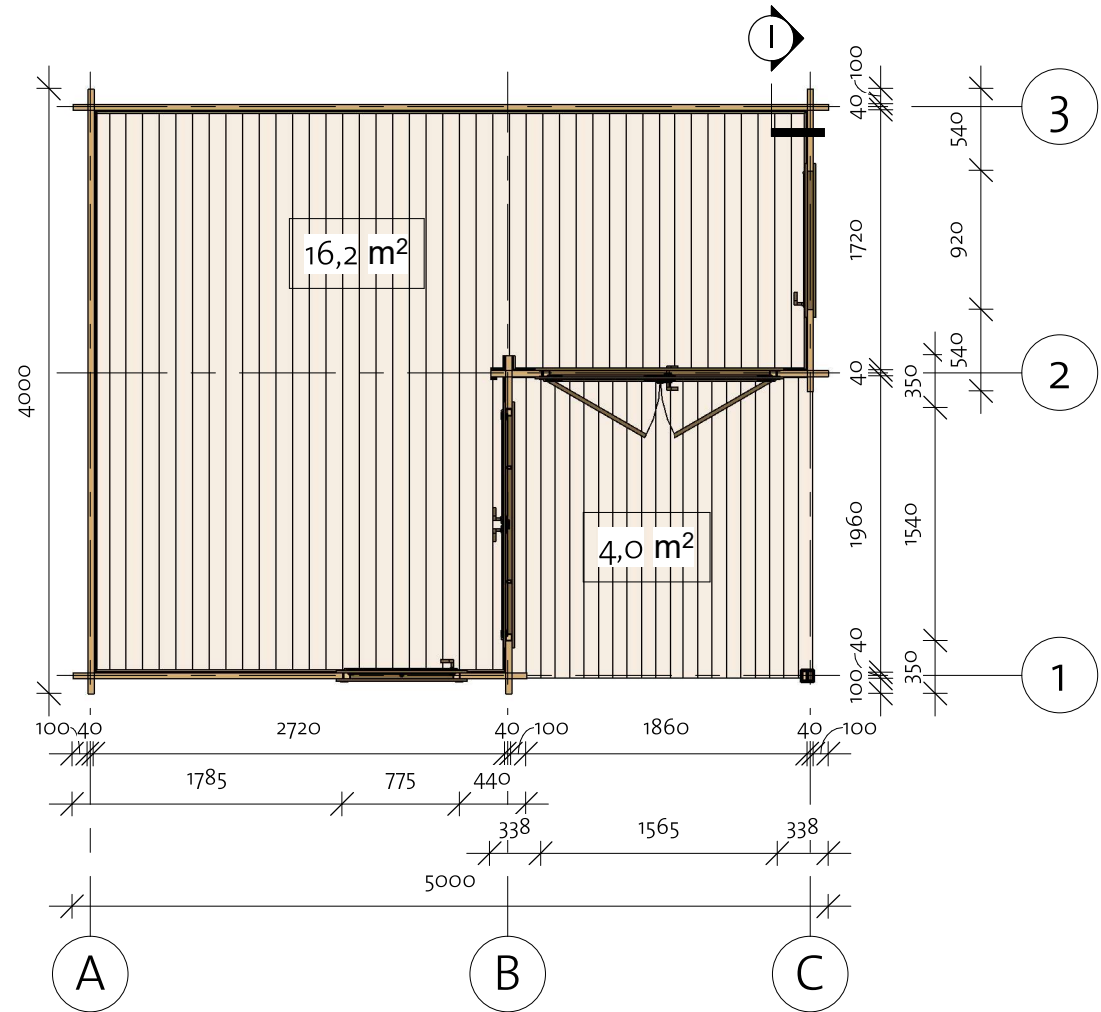
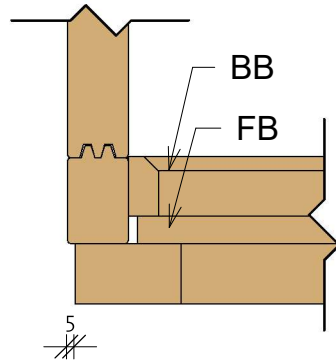
① Baseboard



Floor Schedule				
Mark	Type	Profile	Count	Length

FB1	FB 18x110		19	1749
FB2	FB 18x110		26	3714
FB3	TB 18x95		22	1989

BB	BB 20x40		4	4800
----	----------	---	---	------

# Indigo 40 (480x380)

Wall 1

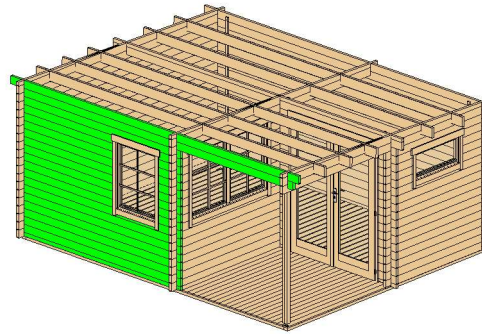

Wall 1			
Mark	Profile	Count	Cut Length

1BL-1	40x57	1	2972
1LG-1	40x114	9	412
1LG-2	40x114	9	1785
1LG-3	40x114	8	2972
1LG-4	40x114	1	5000
1TL-1	40x114	1	5200

Log Profile Wall 1	
Profile	Profile

40x57	
40x114	
40x114	

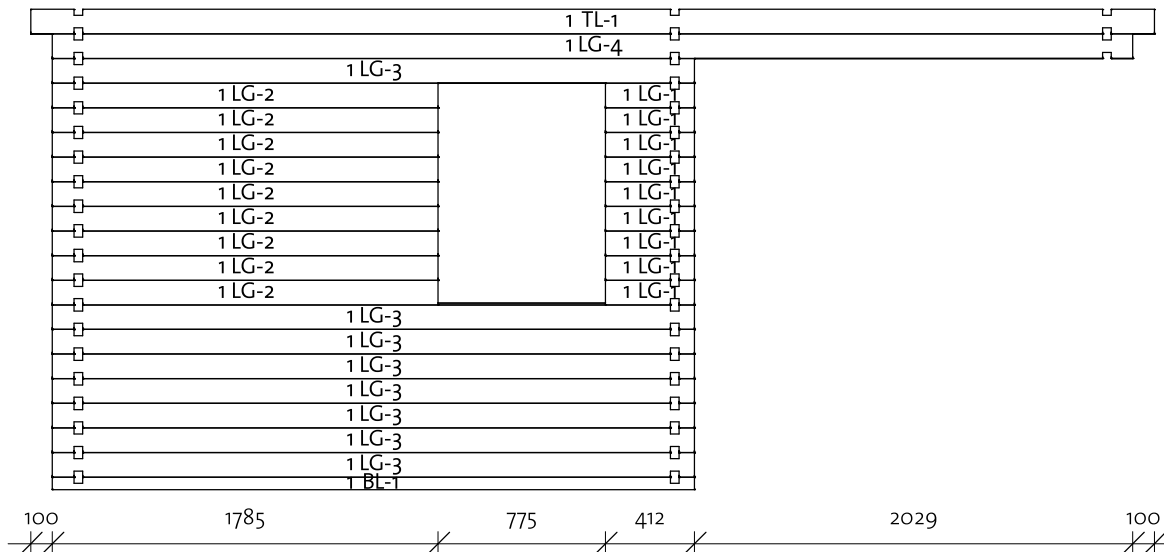

# Indigo 40 (480x380)

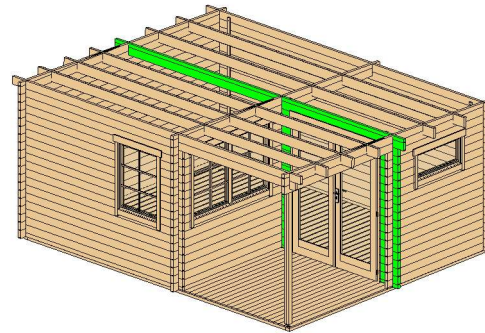

Wall 2



Wall 2			
Mark	Profile	Count	Cut Length

2BL-1	40x57	2	338
2LG-1	40x114	34	338
2LG-2	40x114	1	5200
2TL-1	40x53	1	5200

Log Profile Wall 2	
Profile	Profile

40x57	
40x114	
40x53	

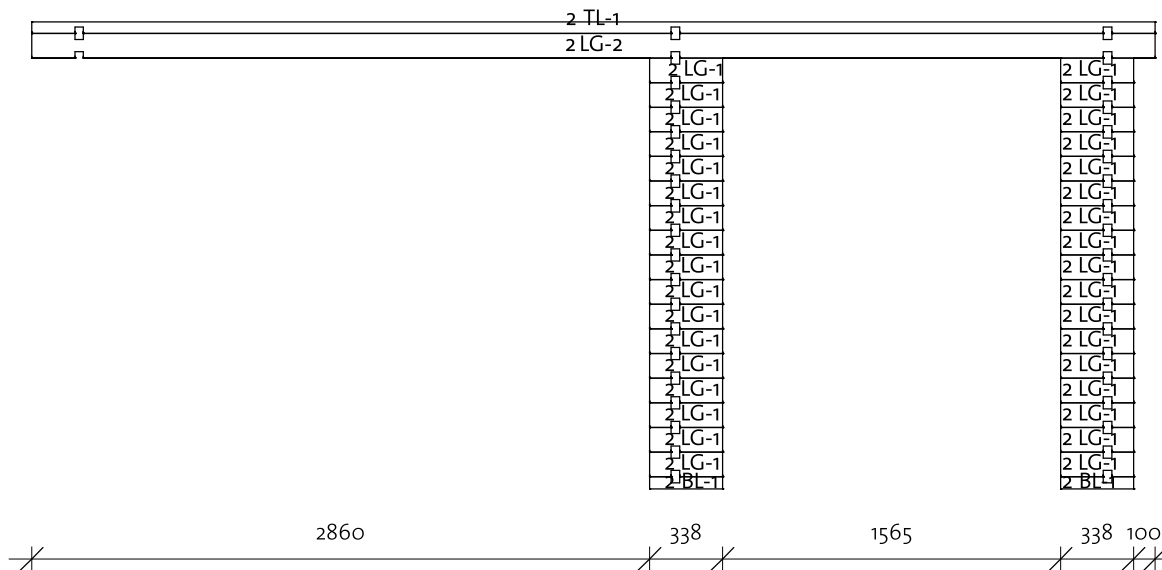

# Indigo 40 (480x380)

Wall 3

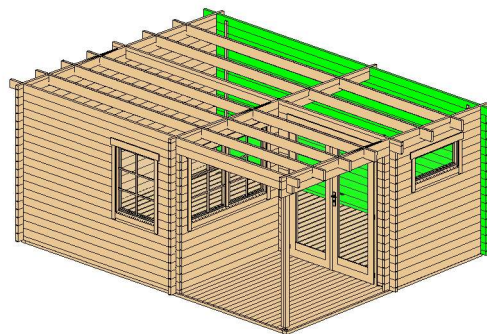

Wall 3			
Mark	Profile	Count	Cut Length

3BL-1	40x57	1	5000
3LG-1	40x114	16	5000
3LG-2	40x114	1	5000
3LG-3	40x114	1	5200

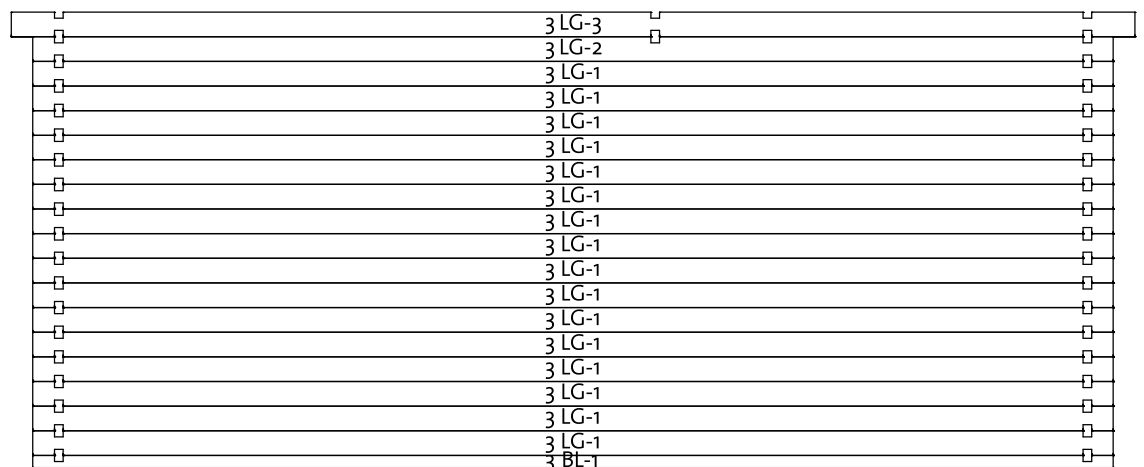

Log Profile Wall 3	
Profile	Profile

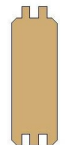
40x57	
40x114	

# Indigo 40 (480x380)

Wall A

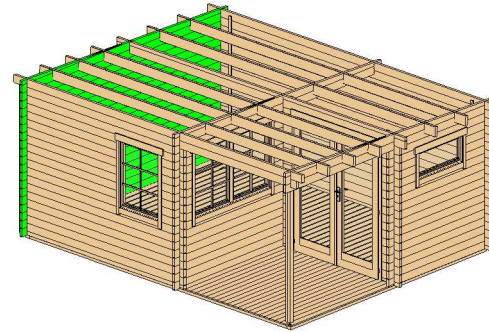

Wall A			
Mark	Profile	Count	Cut Length

ALG-1	40x114	17	4000
ALG-2	40x114	1	4000
ALG-3	40x114	1	4000
ALG-4	40x114	1	1957

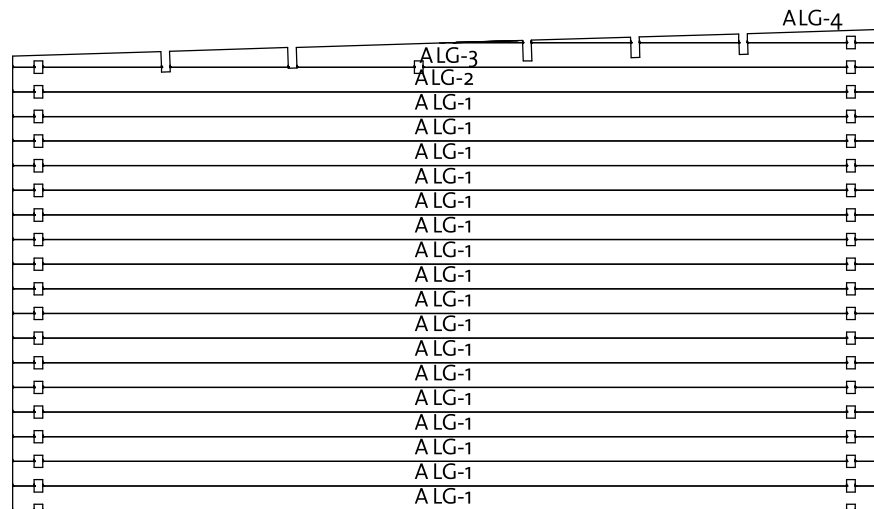

Log Profile Wall A	
Profile	Profile

40x114	
--------	--

# Indigo 40 (480x380)

Wall B

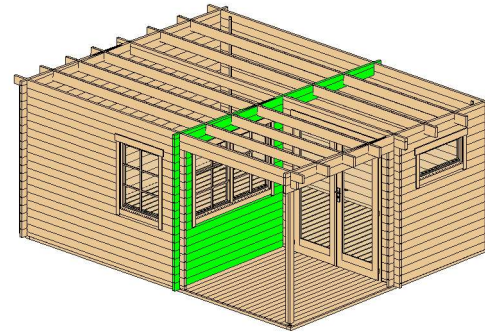

Wall B			
Mark	Profile	Count	Cut Length

BLG-1	40X114	18	350
BLG-2	40X114	1	1957
BLG-3	40X114	8	2240
BLG-4	40X114	1	4000
BLG-5	40X114	1	4000

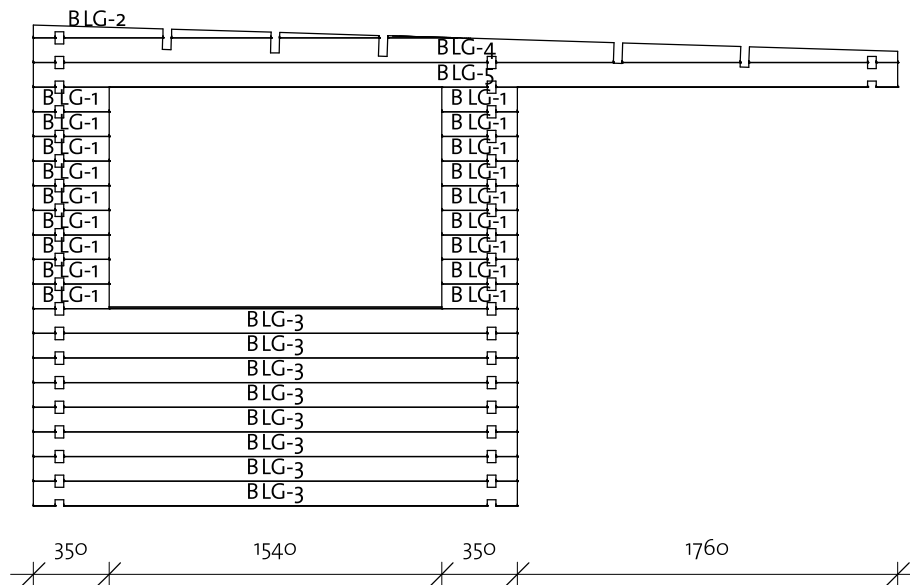

Log Profile Wall B	
Profile	Profile

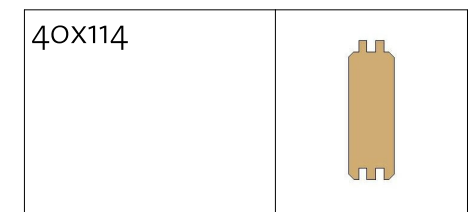



# Indigo 40 (480x380)

Wall C

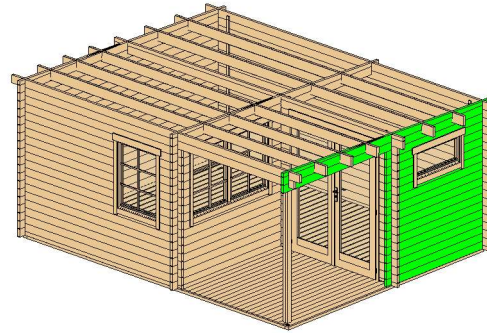

Wall C			
Mark	Profile	Count	Cut Length

CLG-1	40X114	8	540
CLG-2	40X114	1	1957
CLG-3	40X114	13	2000
CLG-4	40X114	1	4000
CLG-5	40X114	1	4000

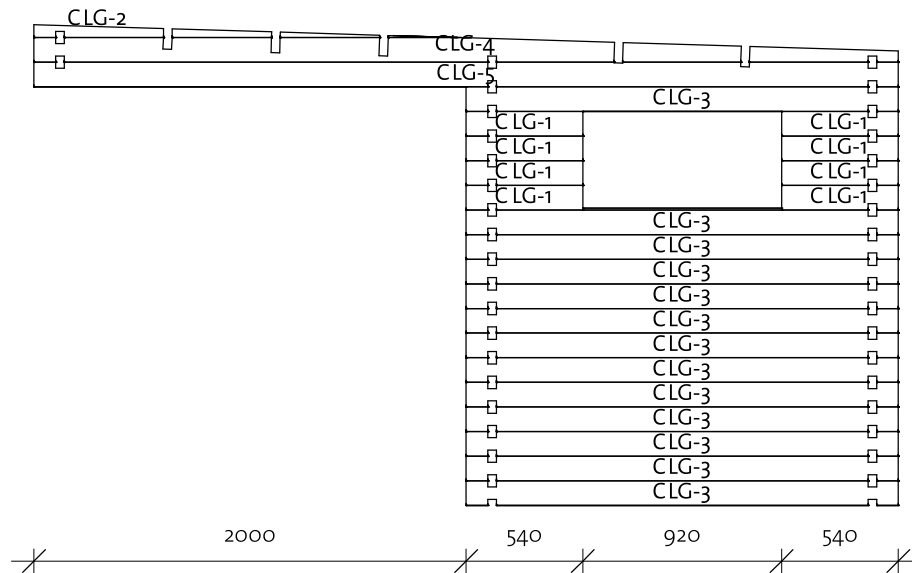

Log Profile Wall C	
Profile	Profile



40X114	
--------	--

# Indigo 40 (480x380)

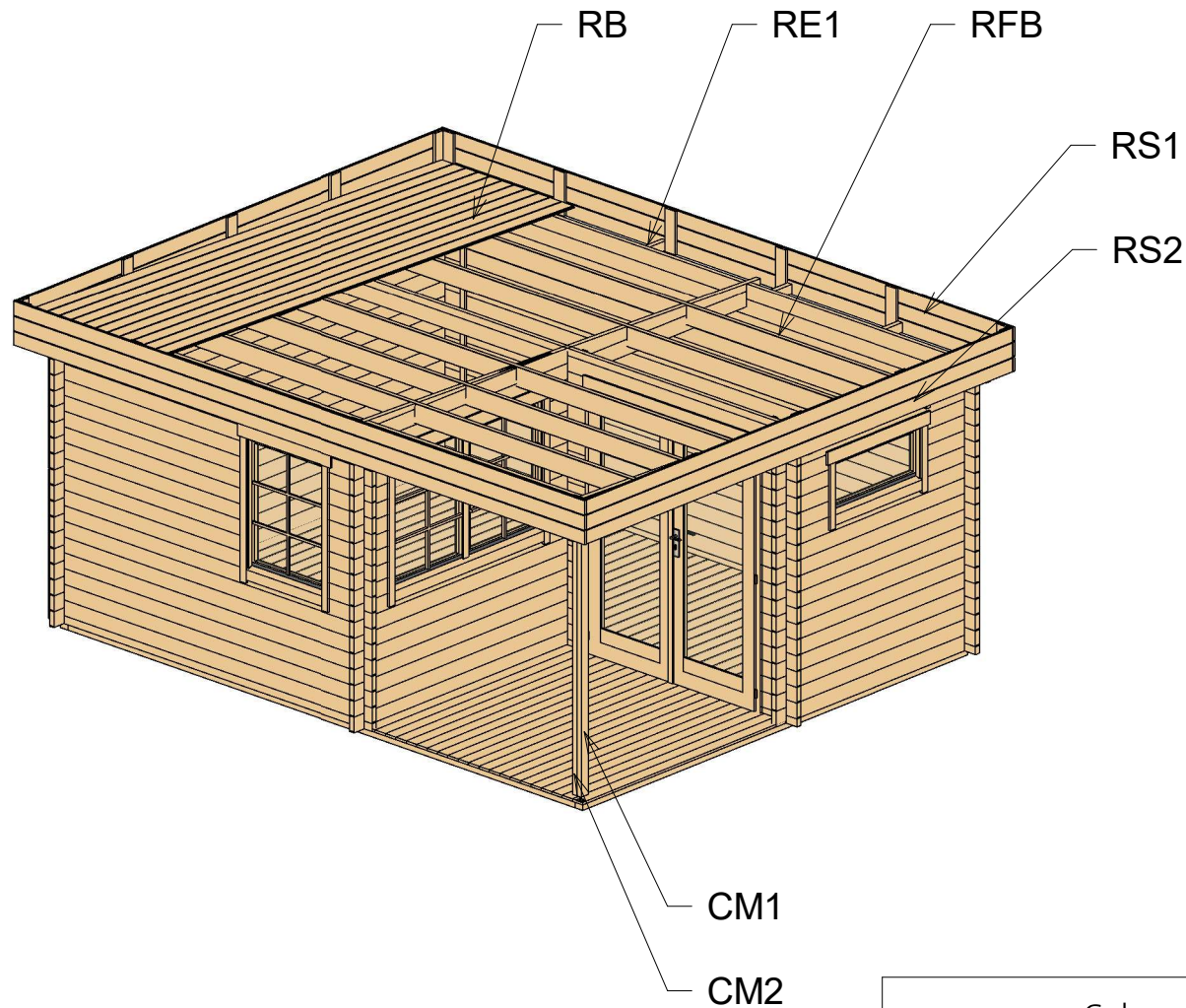
Roof 1

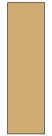

Roof				
Mark	Type	Profile	Count	Length

RB	18x110		49	4170
RE1	40x70		8	200
RFB	Beam 40x143		5	5200

Columns			
Mark	Profile	Count	Length

CM1	Post 70x40	1	1875
CM2	Post 70x40	1	1932

Roof Side Schedule		
Type	Length	Count

RS1	5098	2
RS2	3560	2

# Indigo 40 (480x380)

Roof 2

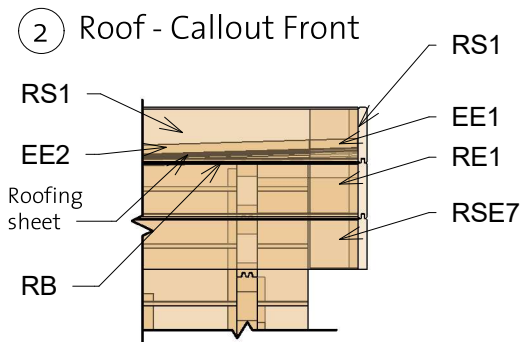
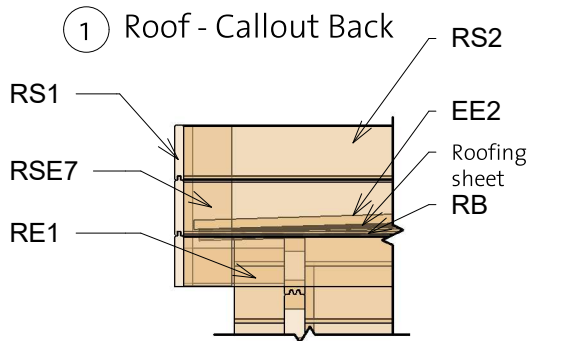
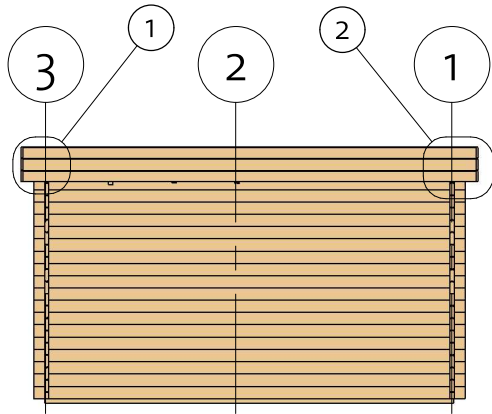

Fascia Schedule				
Mark	Type	Profile	Count	Length
EE1	Eave Edging 18x95		1	5200
EE2	Eave Edging 18x95		2	4085

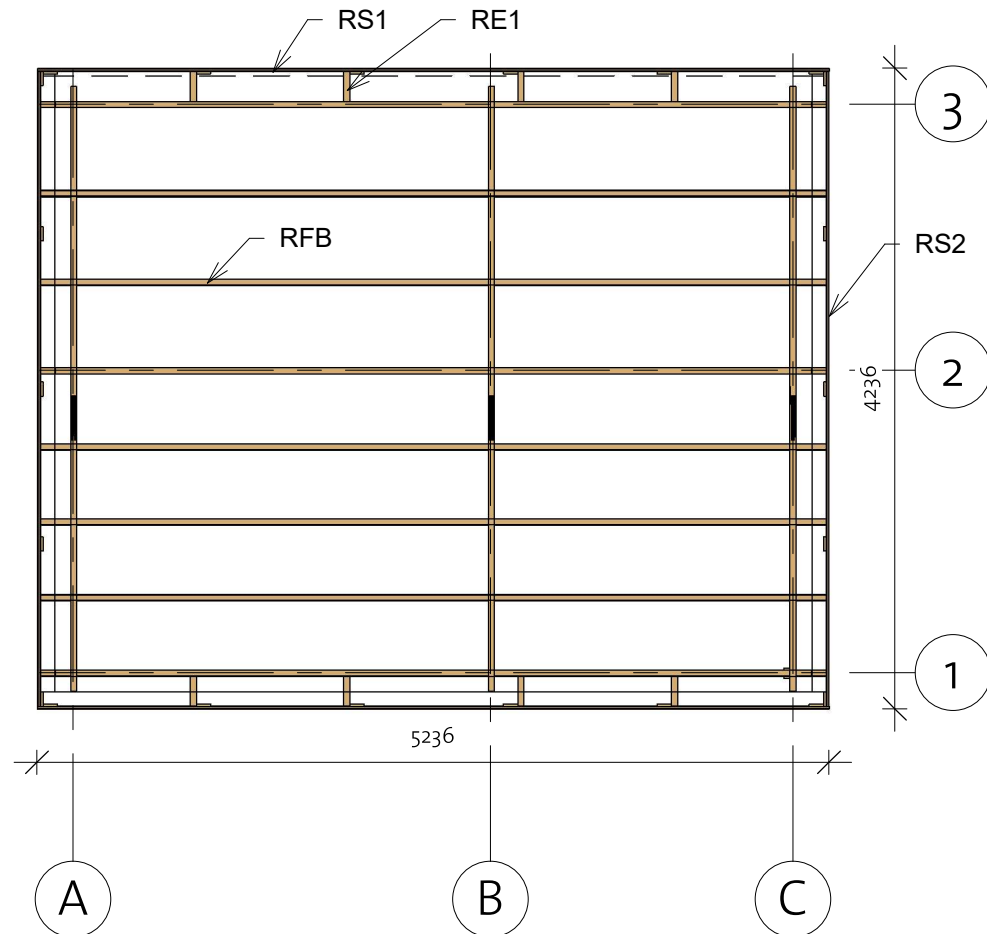

# Indigo 40 (480x380)

Extras

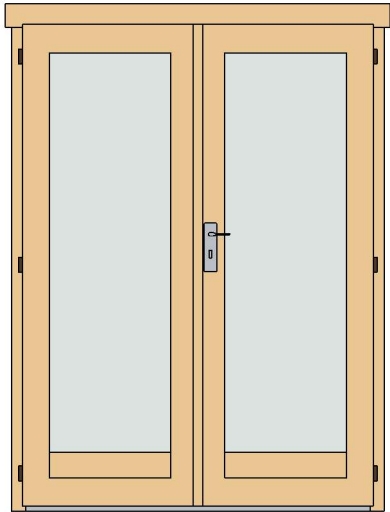

Door Schedule				
Mark	Type	Width	Height	Count
CDD19 R	Classic double door 19, full glass right	1550	1955	1
DB	Door beam 1425 mm	40	12	3

Window Schedule				
Mark	Type	Width	Height	Count
CDW1	Classic double window 1	1530	990	1
CW1R	Classic window 1 right	765	990	1
CW7L	Classic window 7, full glass left	915	420	1

Fasteners & Extras		
Name	Type	Count

Hitblock	300-400 mm	
Bolts	M8 x 70	18
Screws	5,0 x 70	30
Screws	6,0 x 140	42
Nails	1,4 x 40	42
Screws	4,0 x 40	140
Screws	4,0 x 50	880

Type	Count	Length
------	-------	--------

Adjustable post foot face based	1	45
Windboard 18x40	6	2200



WCB6	Windows Crossbar 6	--	--	3
------	--------------------	----	----	---

