

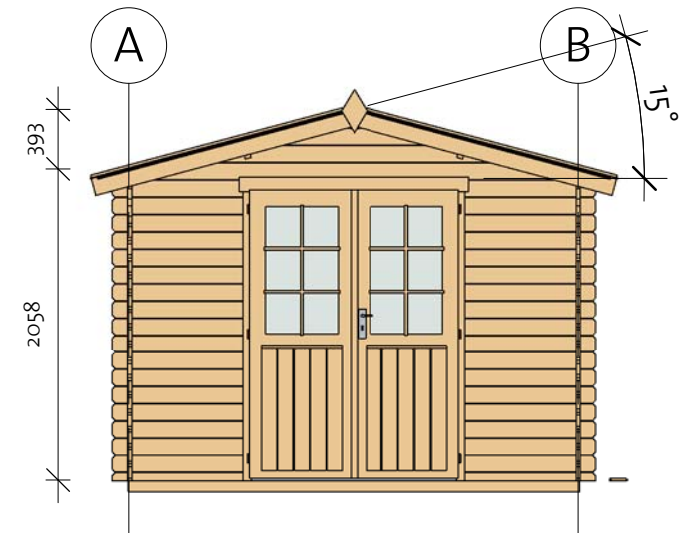

# KENLY 28 (3000x2300)

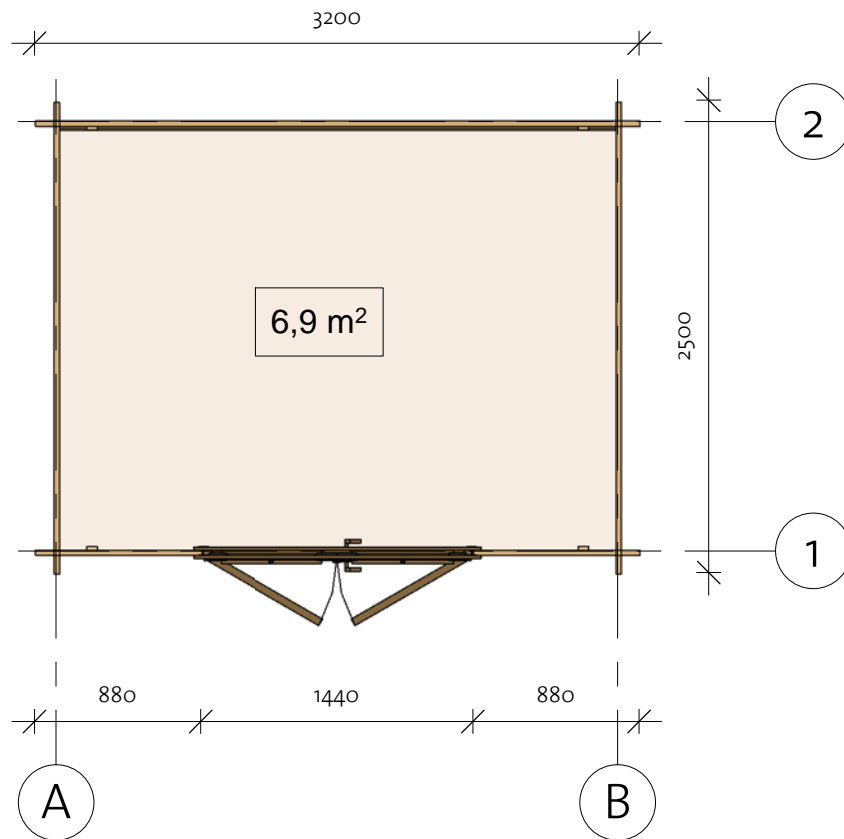
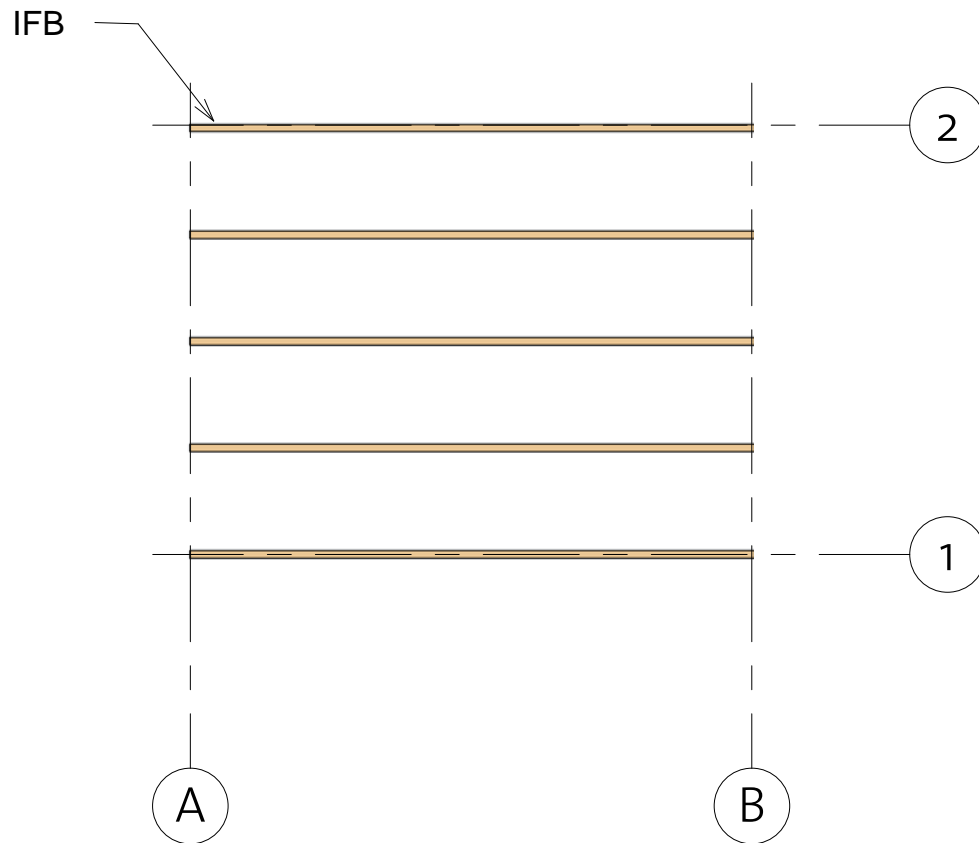

# KENLY 28 (300X230)

Foundation



Impregnated foundation beams				
Mark	Type	Profile	Count	Length
IFB	IFB 40X70		5	2990



# KENLY 28 (300X230)

Floor Plan

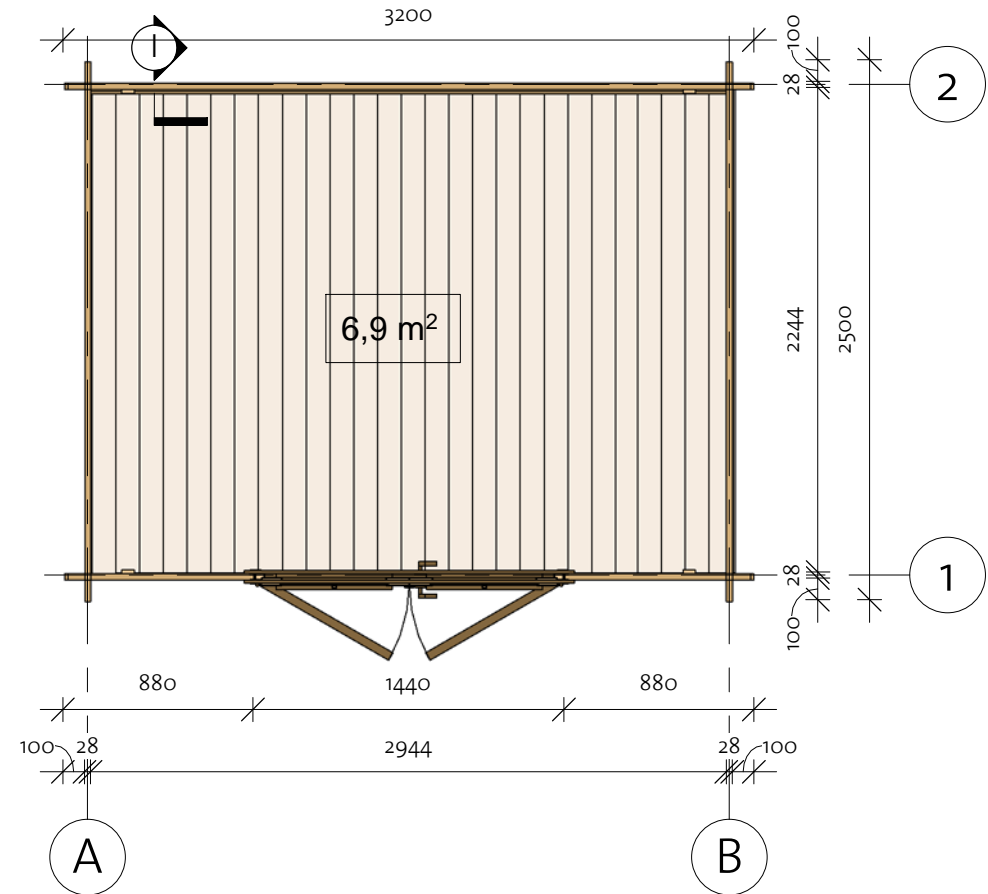
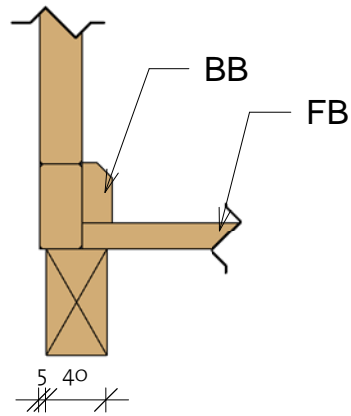
① Baseboard



Floor Schedule

Mark	Type	Profile	Count	Length
FB	FB 18x110		28	2241
BB1	BB 20x40		2	3000
BB2	BB 20x40		2	2300

# KENLY 28 (300X230)

Wall 1

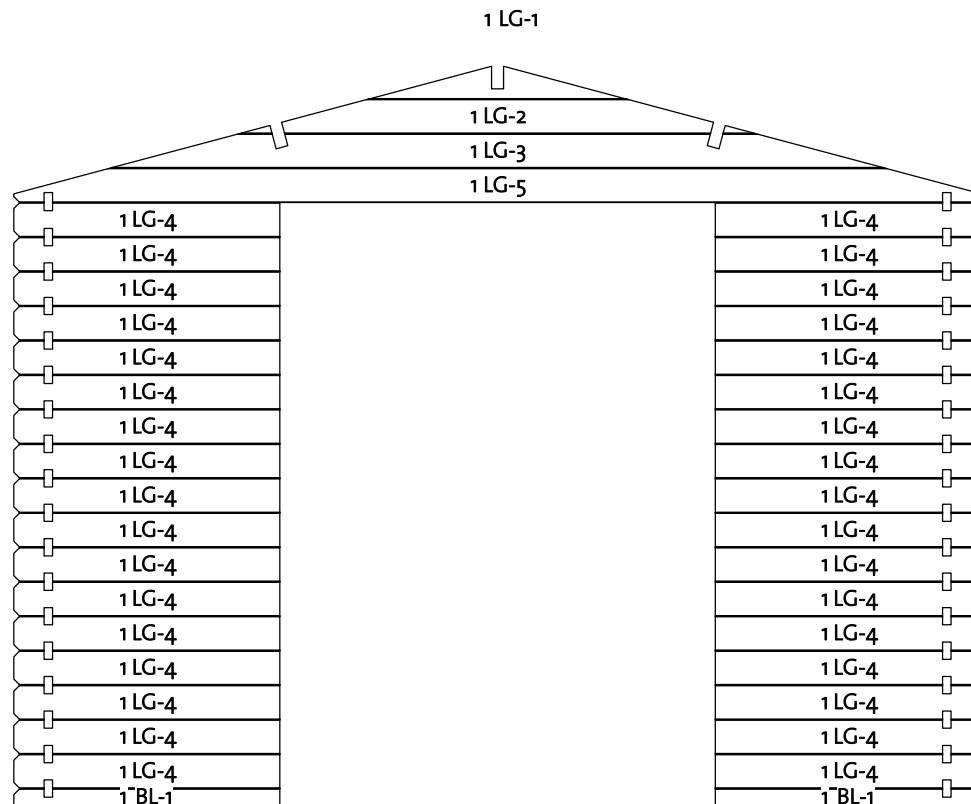
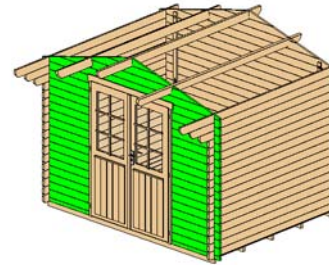



Wall 1			
Mark	Profile	Count	Cut Length

1BL-1	28x57	2	880
1LG-1*	28x114	1	855
1LG-2*	28x114	1	1709
1LG-3*	28x114	1	2562
1LG-4	28x114	34	880
1LG-5*	28x114	1	3200

\*Gable-delivered premounted

Log Profile Wall 1	
Profile	Profile

28x57	
28x114	

# KENLY 28 (300X230)

Wall 1

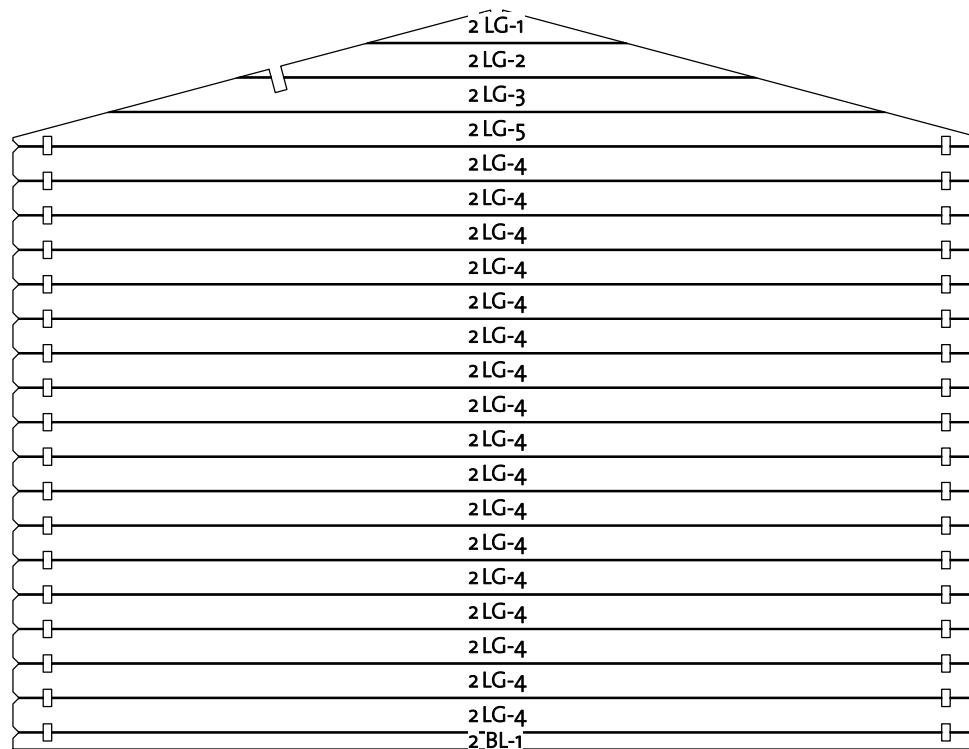
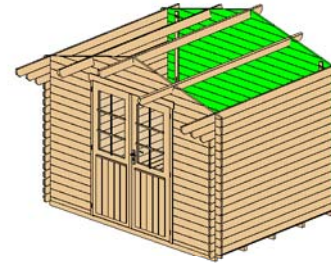



Wall 2			
Mark	Profile	Count	Cut Length

2BL-1	28x57	1	3200
2LG-1*	28x114	1	855
2LG-2*	28x114	1	1709
2LG-3*	28x114	1	2562
2LG-4	28x114	17	3200
2LG-5*	28x114	1	3200

\*Gable-delivered premounted

Log Profile Wall 2	
Profile	Profile

28x57	
28x114	

# KENLY 28 (300X230)

Wall 1

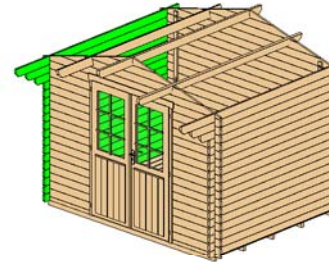

Wall A			
Mark	Profile	Count	Cut Length

ALG-1	28x114	15	2500
ALG-2	28x114	1	2675
ALG-3	28x114	1	2850
ATL-1	28x120	1	3150

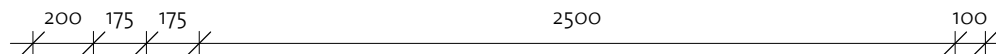
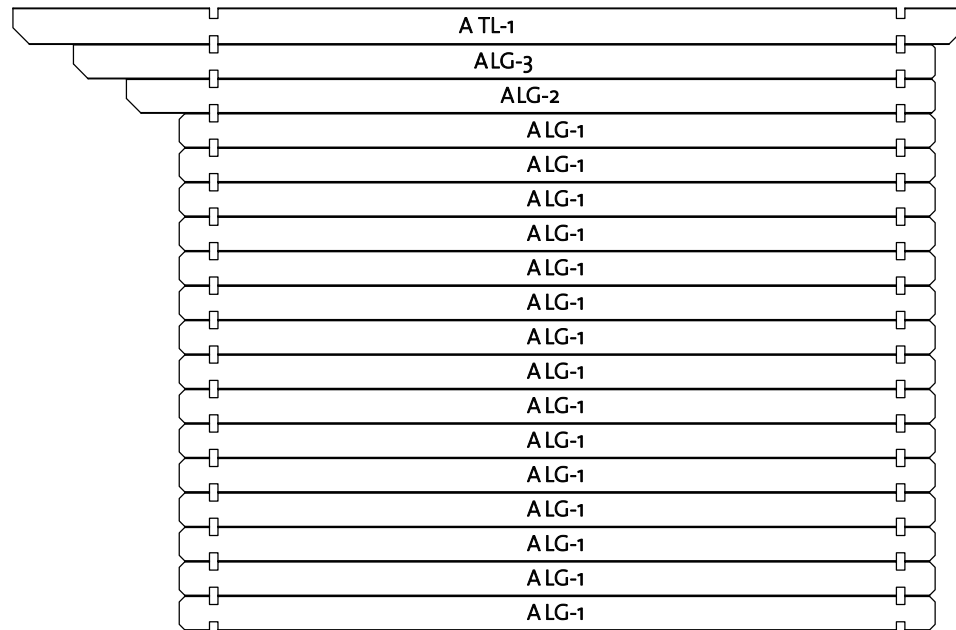

Log Profile Wall A	
Profile	Profile

28x114	
28x120	

# KENLY 28 (300X230)

Wall 1

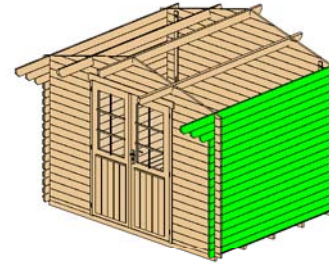

Wall B			
Mark	Profile	Count	Cut Length

BLG-1	28x114	15	2500
BLG-2	28x114	1	2675
BLG-3	28x114	1	2850
BTL-1	28x120	1	3150

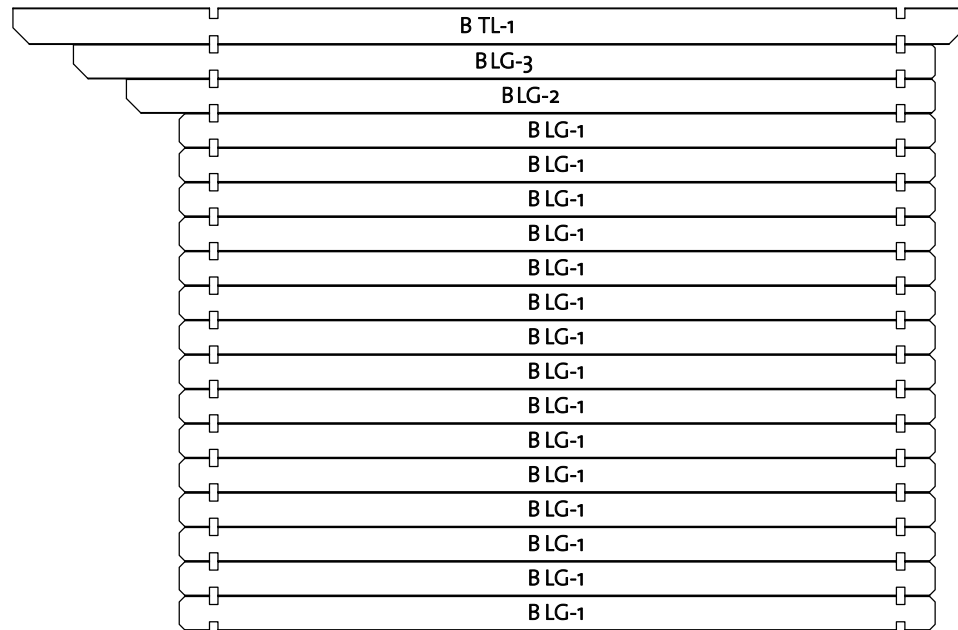

Log Profile Wall B	
Profile	Profile

28x114	
28x120	

# KENLY 28 (300X230)

Roof 1

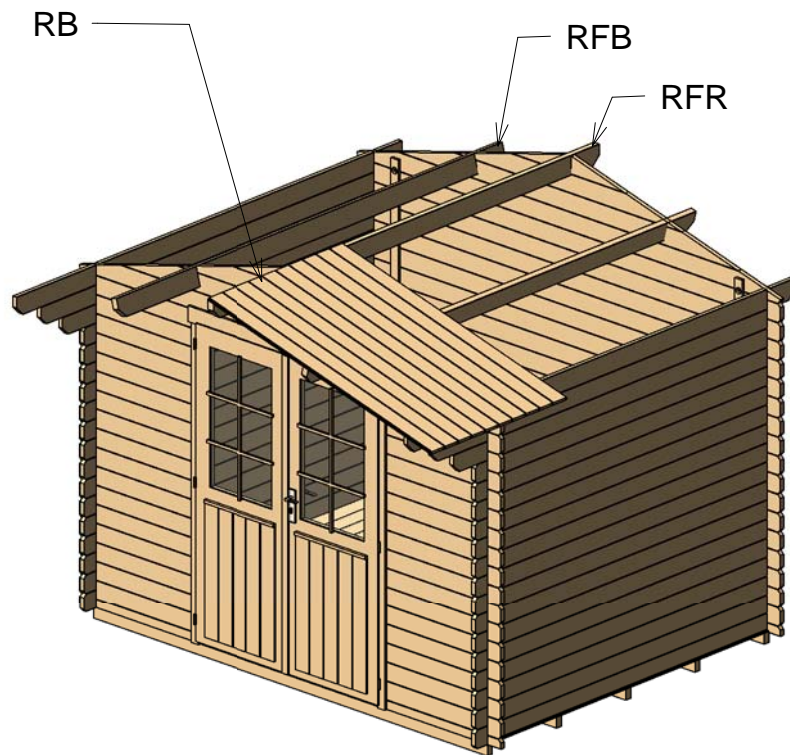

RFR / RFB1 / RFB2				
Mark	Type	Profile	Count	Length

RFB	Beam 40X120		2	3150
-----	----------------	---	---	------

RFR	Beam 40X120		1	3150
-----	----------------	---	---	------

Roof				
Mark	Type	Profile	Count	Length

RB	18x110		60	1755
----	--------	---	----	------



# KENLY 28 (300X230)

Roof 2

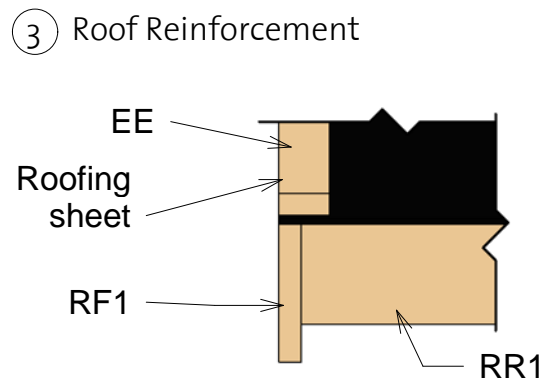
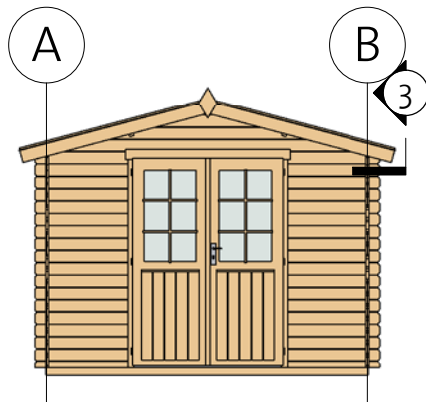
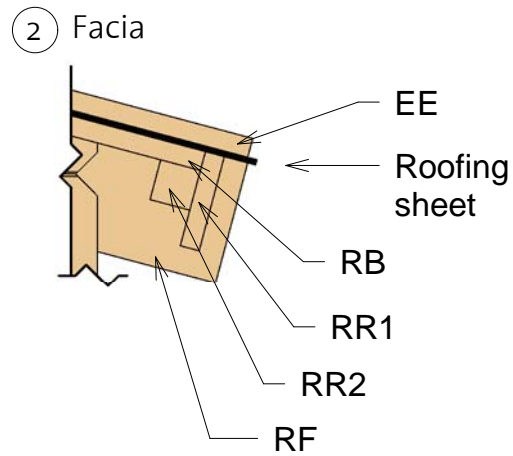
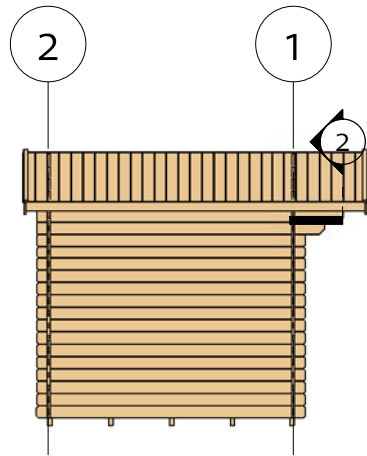

Fascia Schedule				
Mark	Type	Profile	Count	Length
EE	Eave Edging 18x40		4	1800
RF	Roof Fascia 18x115		4	1800
RR1	Roof reinforcement 18x90		2	3150
RR2	Roof reinforcement 38x38		2	3150

# KENLY 28 (300X230)

Extras



Door Schedule				
Mark	Type	Width	Height	Count
BDD1R	Basic double door 1 right	1425	1955	1
DCB6	Door Crossbar 6	--	--	2



Type	Count	length
------	-------	--------

Windboard 18x40	4	2200
-----------------	---	------

Fasteners/Extras		
	Type	Count

Hitblock	300-400 mm	
Screws	5,0 x 70	10
Bolts	M8 x 60	12
Screws	6,0 x 140	30
Nails	1,4 x 40	30
Screws	4,0 x 40	70
Screws	4,0 x 50	340

Family	Count
--------	-------

Romb	2
------	---





# KENLY 28 (300X230)

## List of all items 1

### Impregnated foundation beams

Mark	Type	Profile	Count	Length
IFB	IFB 40x70		5	2990





### Floor Schedule

Mark	Type	Profile	Count	Length
FB	FB 18x110		28	2241
BB1	BB 20x40		2	3000
BB2	BB 20x40		2	2300



### Roof

Mark	Type	Profile	Count	Length
RB	18x110		60	1755

### Fascia Schedule

Mark	Type	Profile	Count	Length
EE	Eave Edging 18x40		4	1800
RF	Roof Fascia 18x115		4	1800
RR1	Roof reinforcement 18x90		2	3150
RR2	Roof reinforcement 38x38		2	3150

### RFR / RFB1 / RFB2

Mark	Type	Profile	Count	Length
RFB	Beam 40x120		2	3150
RFR	Beam 40x120		1	3150

# KENLY 28 (300x230)

## List of all items 2

Wall 1			
Mark	Profile	Count	Cut Length

1BL-1	28x57	2	880
1LG-1*	28x114	1	855
1LG-2*	28x114	1	1709
1LG-3*	28x114	1	2562
1LG-4	28x114	34	880
1LG-5*	28x114	1	3200

Wall 2			
Mark	Profile	Count	Cut Length

2BL-1	28x57	1	3200
2LG-1*	28x114	1	855
2LG-2*	28x114	1	1709
2LG-3*	28x114	1	2562
2LG-4	28x114	17	3200
2LG-5*	28x114	1	3200

\*Gable-delivered premounted



Wall A			
Mark	Profile	Count	Cut Length

ALG-1	28x114	15	2500
ALG-2	28x114	1	2675
ALG-3	28x114	1	2850
ATL-1	28x120	1	3150

Wall B			
Mark	Profile	Count	Cut Length

BLG-1	28x114	15	2500
BLG-2	28x114	1	2675
BLG-3	28x114	1	2850
BTL-1	28x120	1	3150

Log Profiles	
Profile	Profile

28x57	
28x114	

Log Profiles	
Profile	Profile

28x120	
--------	---