

Installation manual

Montageanleitung • Notice de montage • Istruzioni per il montaggio • Manual de montaje • Monteringsanvisning • Installatiegids • Montážní návod • Asennusohje • Installationsmanual • Instrukcja instalacji • Paigaldusjuhend

Log cabin FR28-3829

Blockhaus • Maissonnette en poutres • Casa di travi • Casa de jardin • Anneks • Tuinhuis • Zahradní domek • Timmerstuga • Hirsimökki • Dom z bali • Freesprussmaja

Width 380 x Depth 296 cm







Breite/Tiefe • Largeur/Profondeur • Lunghezza/Profondità • Ancho/Profundidad • Bredde/Dybde • Breedte/Diepte • Šířka/Hloubka • Leveys/Pituus • Bredd/Längd • Szerokość/Głębokość • Laius/pikkus

Log thickness 28 mm

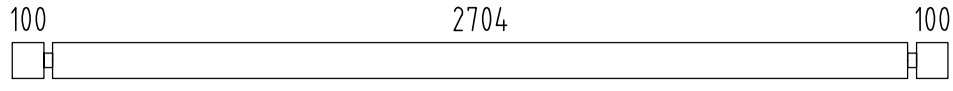
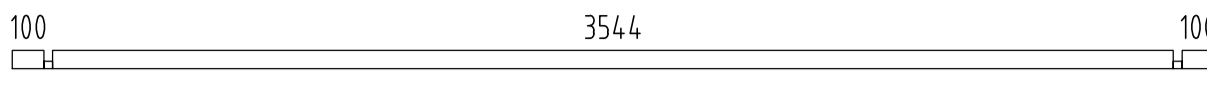
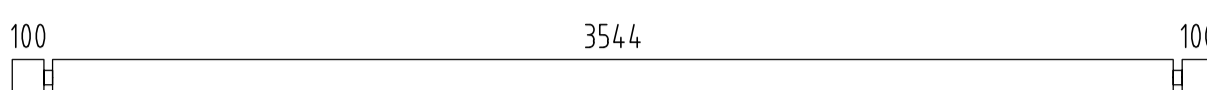
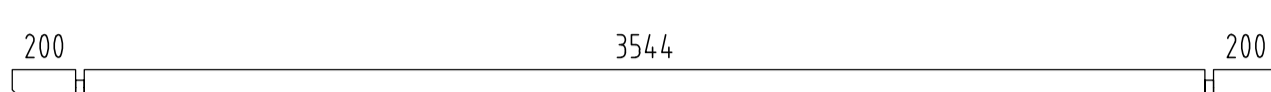
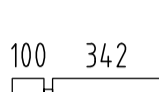
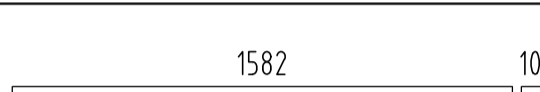
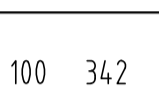
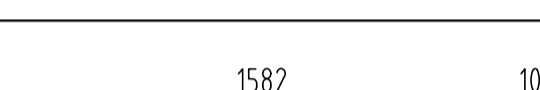
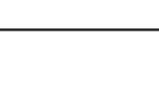
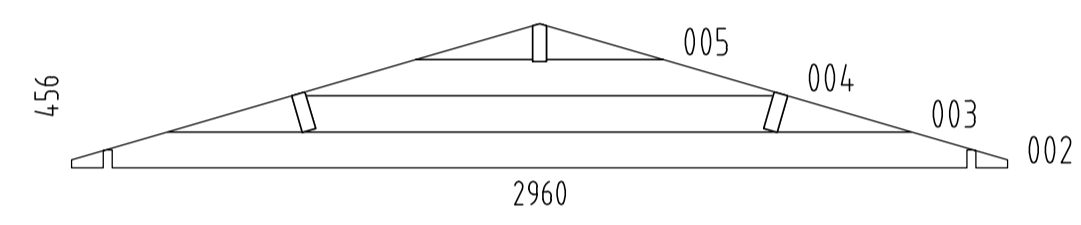
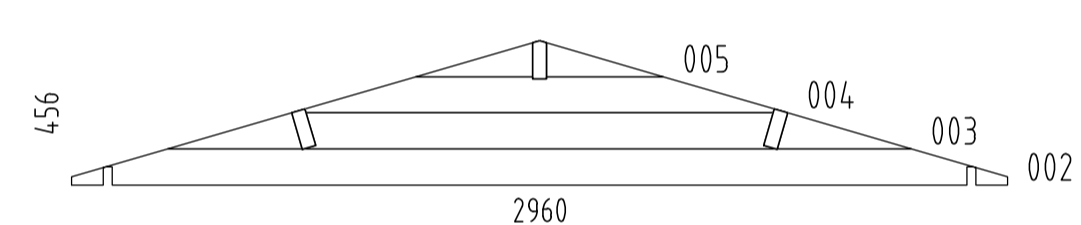
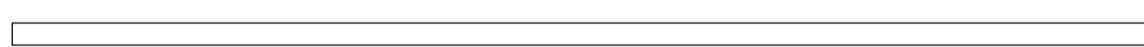

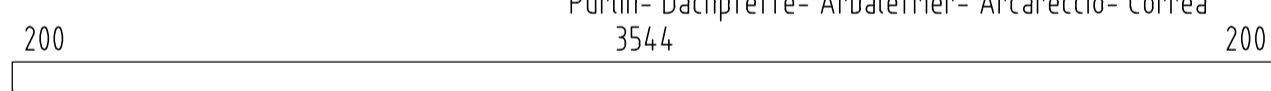
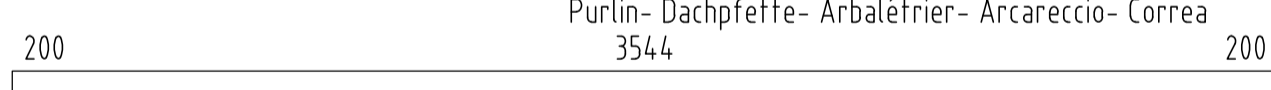

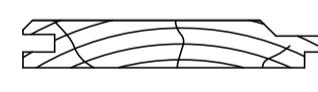
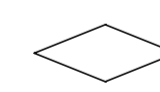
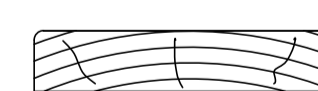
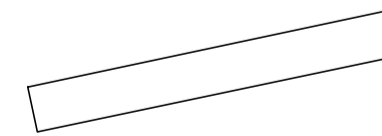

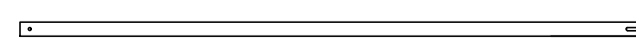

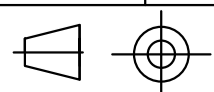

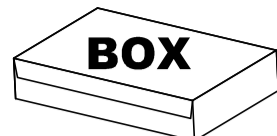
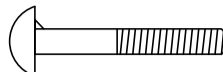
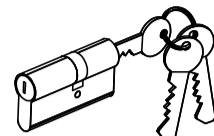
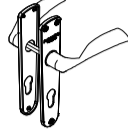

Bohlenstärke • Épaisseur des murs • Spessore delle pareti • Grosor de pared • Tykkelse • Wanddicke • Tloušťka stěny • Seinän paksuus • Väggtjocklek • Grubość ścian • Seinapaksus

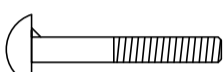

The producer shall have the right to make technical changes to the product • Technische Änderungen vorbehalten • Le producteur réserve le droit d'effectuer des modifications techniques au produit • Il produttore mantiene il diritto di apportare modifiche tecniche al prodotto • Reservado el derecho a modificaciones técnicas • Produsent forbeholder seg retten til å endre tekniske egenskaper ved produktet • Alle rechten en technische wijzigingen voorbehouden • Výrobce si vyhrazuje právo na technické změny výrobku • Valmistaja pidättää oikeuden tehdä tuotteeseen teknisiä muutoksia • Tillverkaren har rätt att utföra tekniska förändringar för produkten • Producent zastrzega sobie prawo do dokonywania zmian technicznych produktu • Tootja jätab endale õiguse muuta toote tehnilisi omadusi

Pos	SPECIFICATION-STÜCKLISTE-NOMENCLATURE-ELEMENTI-ESPECIFICACIÓN FR28-3829	Pcs	Profile (mm)	Length (mm)
001		36	28x114	2960
006		1	28x57	3800
007		18	28x114	3800
008		2	28x114	4000
009		1	28x57	470
010		1	28x57	1710
011		27	28x114	470
012		5	28x114	1710
013		11	28x114	465
W1-1		1		
W2-1		1		
AR1	Foundation- Fundament- Fondation- Fondazione- Vigas de cimentación 	6	45x70	3590
Sl1	Slat- Leiste- Baguette- Listello- Listón 	1	19x28	1620
PR1	Purlin- Dachpfette- Arbalétrier- Arcareccio- Correa 	2	44x140	4000
PR2	Purlin- Dachpfette- Arbalétrier- Arcareccio- Correa 	1	44x140	4000
FB2-1	Floor board- Fussbodenbrett- Madrier du plancher - Tavola pavimento- Tabla de suelo 	40	89x19	2698
RB1-1	Roof board- Dachbrett- Madrier du toit- Tavola tetto- Tabla de tejado 	90	89x16	1750
Dia-1	Diamond- Deckbrett- Madrier- Tavola di copertura- Rombo 	2	19x140	300
EaE1-1	Eave edging- Dachrandbrett- Madrier en bordure du toit- Tavola bordo tetto- Tabla de valadizo 	2	16x95	4000
FaB3-1	Facia board- Giebelblende- Écran frontal- Schermo frontone- Tabla de facia 	4	16x120	1770
FLB2-1	Floor beading- Fussbodenleiste- Baguette du plancher- Listello pavimento- Listón de suelo 	5	19x19	2744
RE2-1	Roof edge reinforcement- Dachrandleiste- Baguette en bordure du toit- Rinforzo bordo tetto- Refuerzo borde tejado 	2	32x40	4000
StB1-1	Storm brace- Sturmleiste- Protection contre le vent- Antivento- Protector contra tormentas 	4	25x45	2050

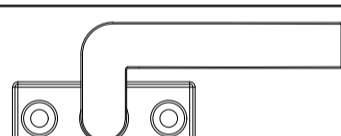
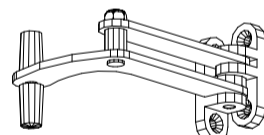
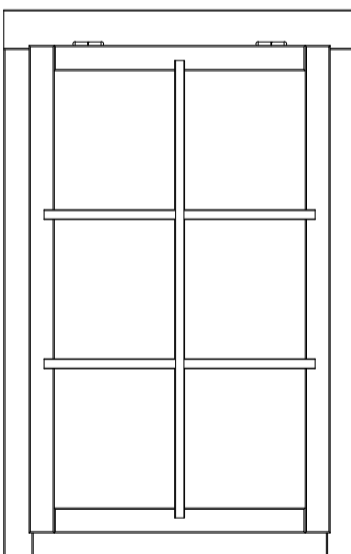
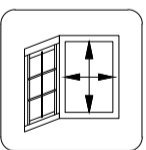

Pos	SPECIFICATION-STÜCKLISTE-NOMENCLATURE-ELEMENTI-ESPECIFICACIÓN FR28-3829	Pcs	Profile (mm)	Length (mm)
Fim	-Fixing kit- Befestigungsset- Moyens de fixation- Materiale di fissaggio- Kit de fijación		1	USE
QPOYP 8x60Zn	Bolt -Schloss-schraube -Boulon- Bullone- Perno- M8x60mm PUP0		8	StB1-1
QULSI 30x35	Cylinder- Zylinderschloss- Serrure a mortaiser- Serratura a cilindro- Bombin- 30.35		1	TU28-16P
QLIU KAPal	Door fittings- Türbeschlag- Ferrure- Ferramenta porta- Manilla puerta- QLIUKAPal		1	TU28-16P
QRV1 20Zn	Keeper- Schliessblech- Tole- Lamiera- Aldaba de candado- 120Zn		1	TU28-16P
QNA1 4x40Me	Nail- Nagel- Clou- Chiodo- Clavo- 1.4x40mm		40	FIB2-1
QNA2 2x50Zn	Nail- Nagel- Clou- Chiodo- Clavo- 2.5x50mm		520	FB2-1; RB1-1
QMUK K8Zn	Nut- Schraubenmutter- Écrou- Dado- Tuerca- M8mm		8	
QKRPP2 _5x16Zn	Screw- Schraube- Vis- Vite- Tornillo- 2.5x16mm Zn		2	
QKRPP3 _5x40Zn	Screw- Schraube- Vis- Vite- Tornillo- 3.5x40mm		80	EaE; Dia; FaB; RE
QKRPP 3x20Zn	Screw- Schraube- Vis- Vite- Tornillo- 3x20mm		22	A28-22Y; TU28-16P
QKRPP4 _5x70Zn	Screw- Schraube- Vis- Vite- Tornillo- 4.5x70mm		25	SlA-1; 006; 008; 009; 010
QKRPP 5x90Zn	Screw- Schraube- Vis- Vite- Tornillo- 5x90mm		16	TU28-16P; PRx
QSE8 x22Zn	Washer- Dichtscheibe- Joint- Rondella- Arandela- 8x22mm		8	
QLIA-P	Window fittings- Fenstergriff- Poigne de la fenêtre- Maniglia finestra- Manilla- QLIA-P		1	A28-22Y
QFK1 40Zn	Window stop- Fensterfeststelle- Crémaillere- Fissativo finestra- Fijador de ventana- QFK140Zn		1	A28-22Y
A28-22Y	Window - Fenster - Fenetre - Finestra-Ventana 765x1210   665x1110mm	1		

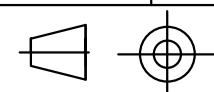

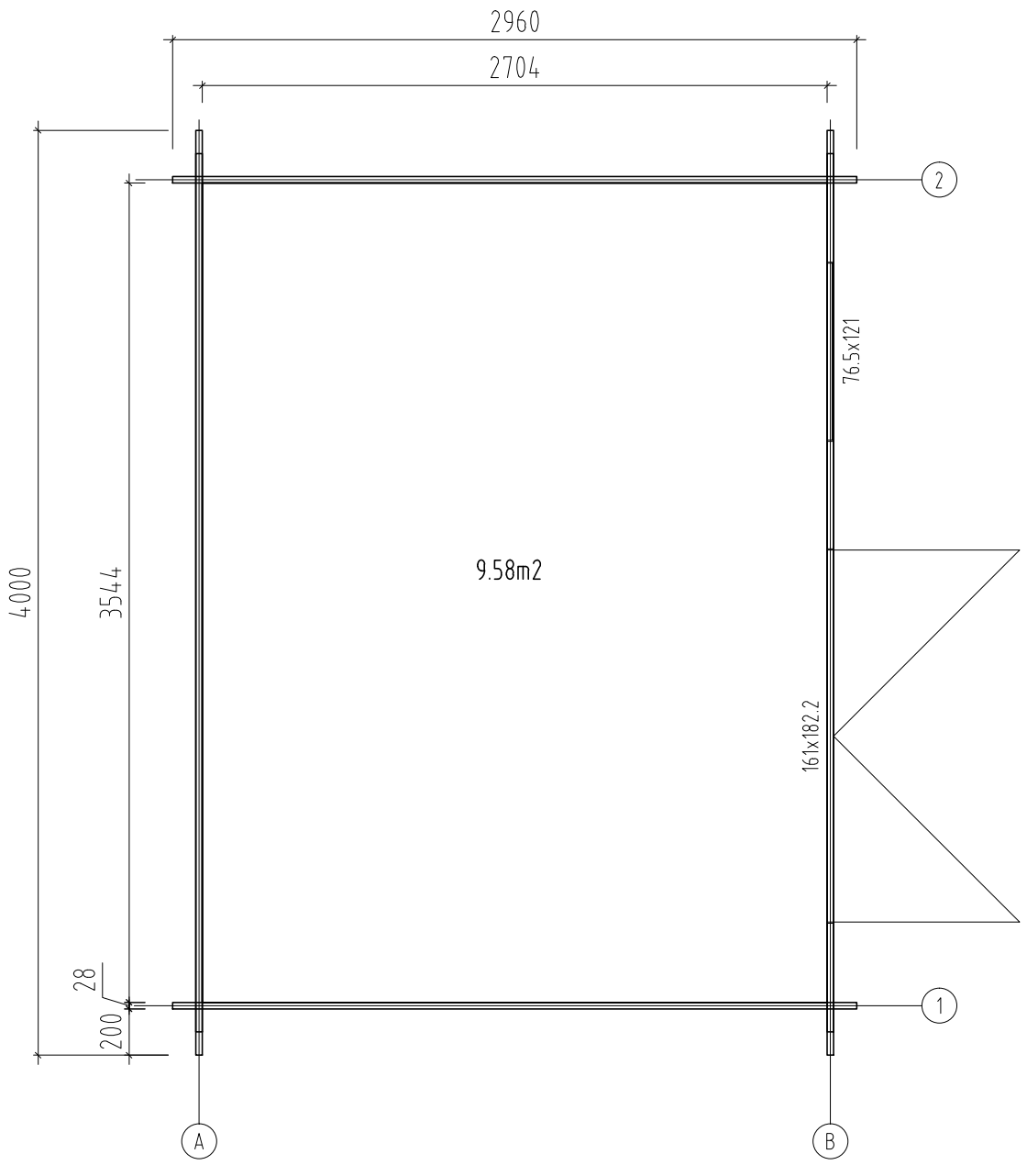

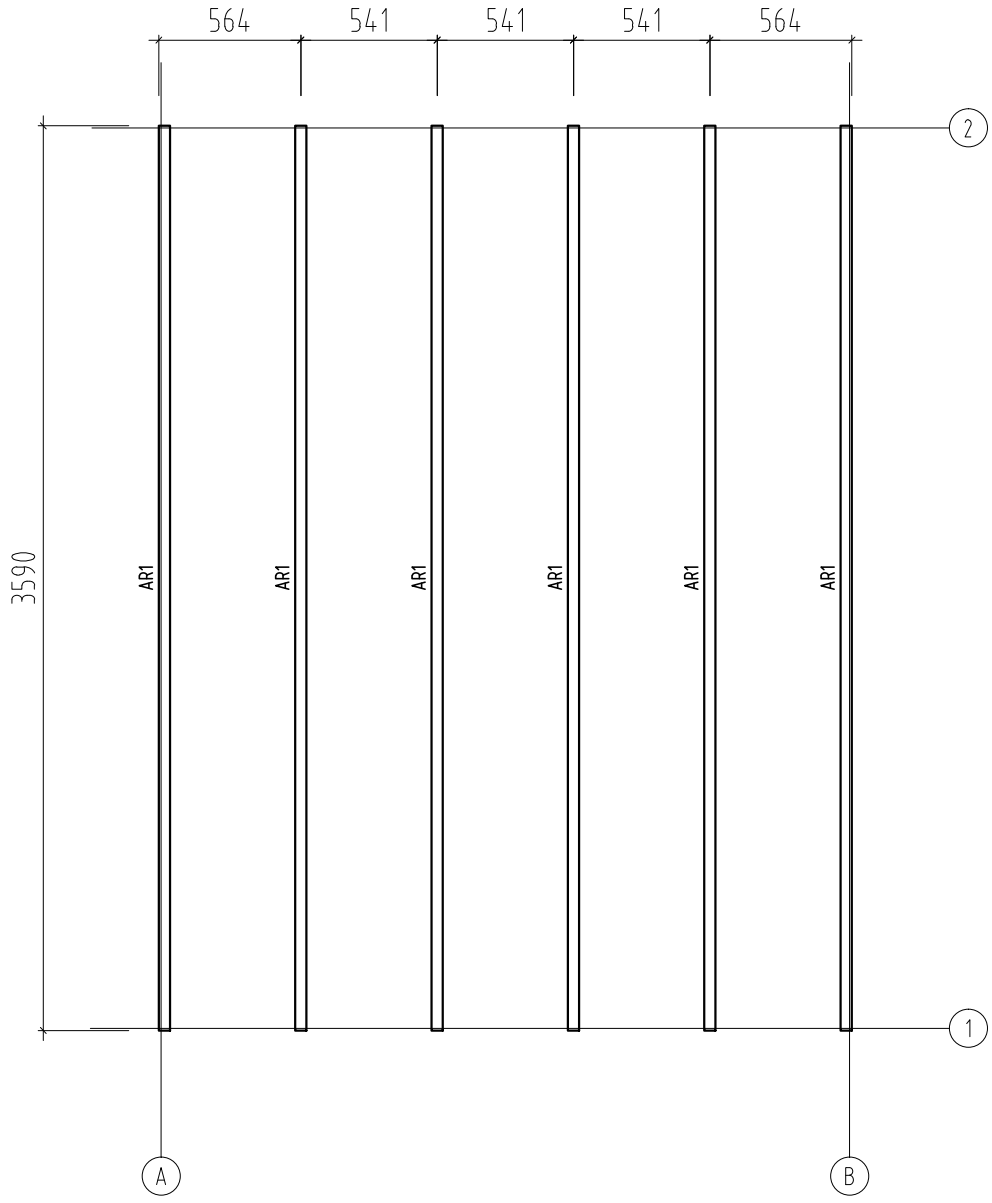

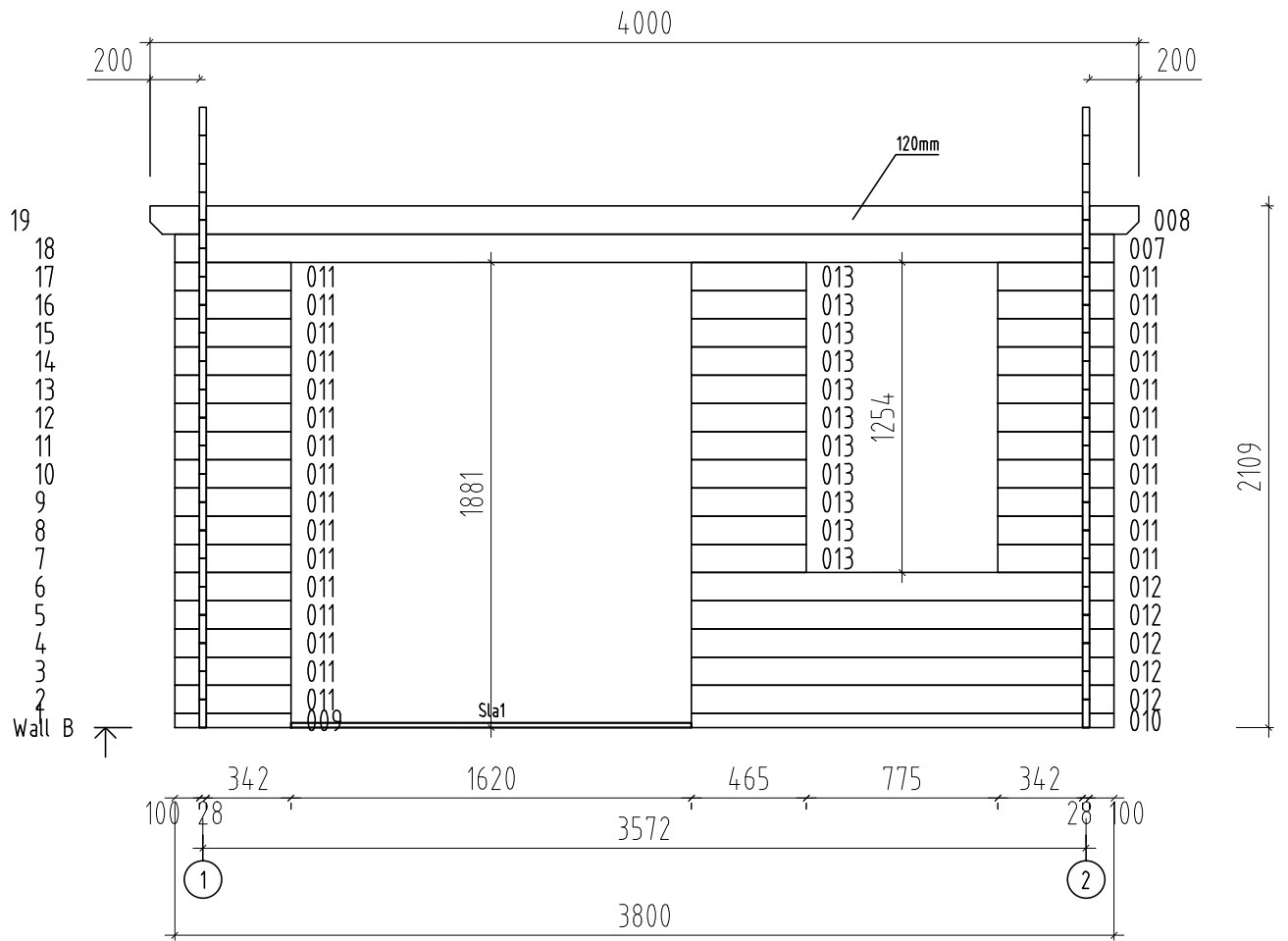

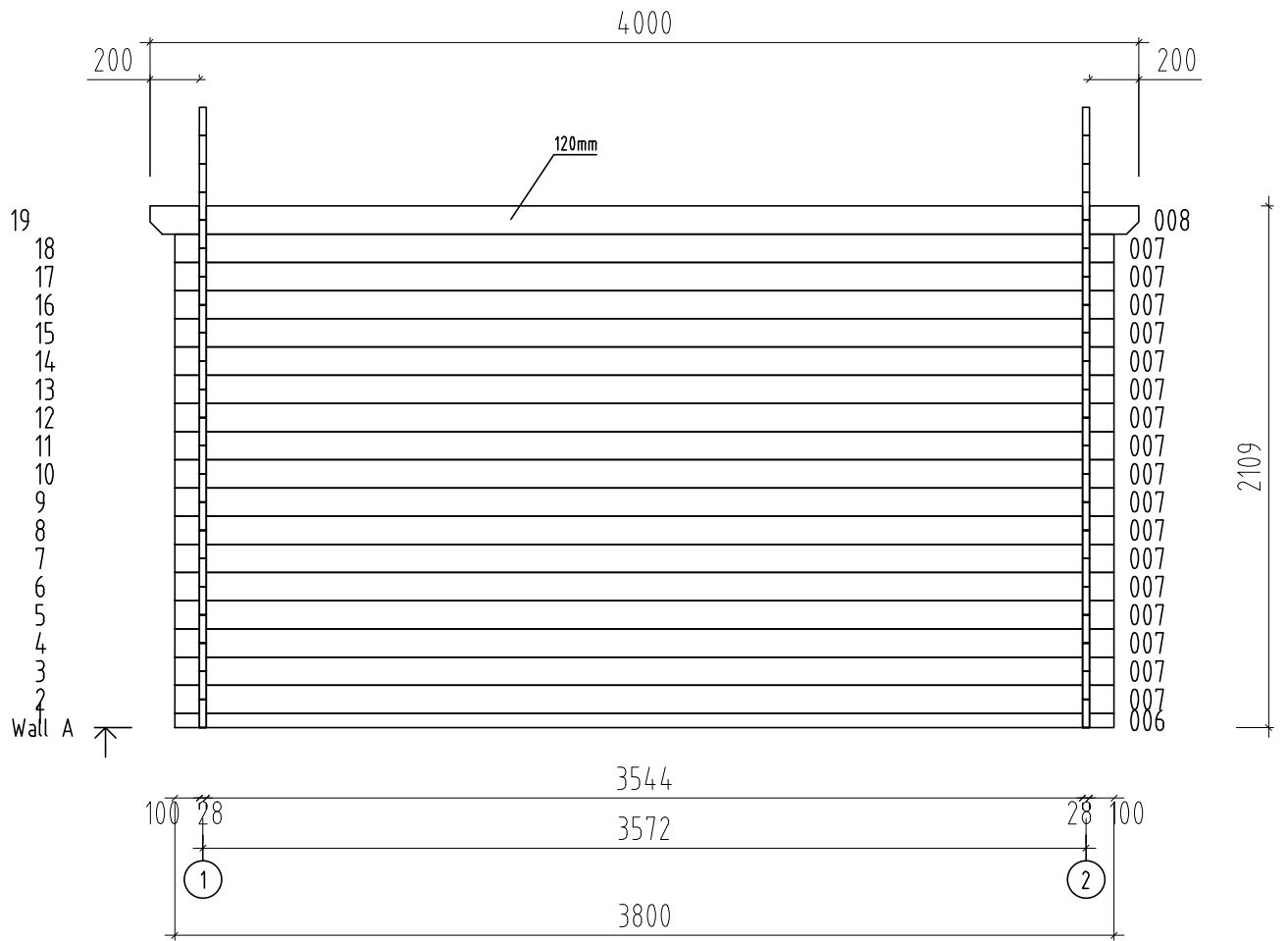

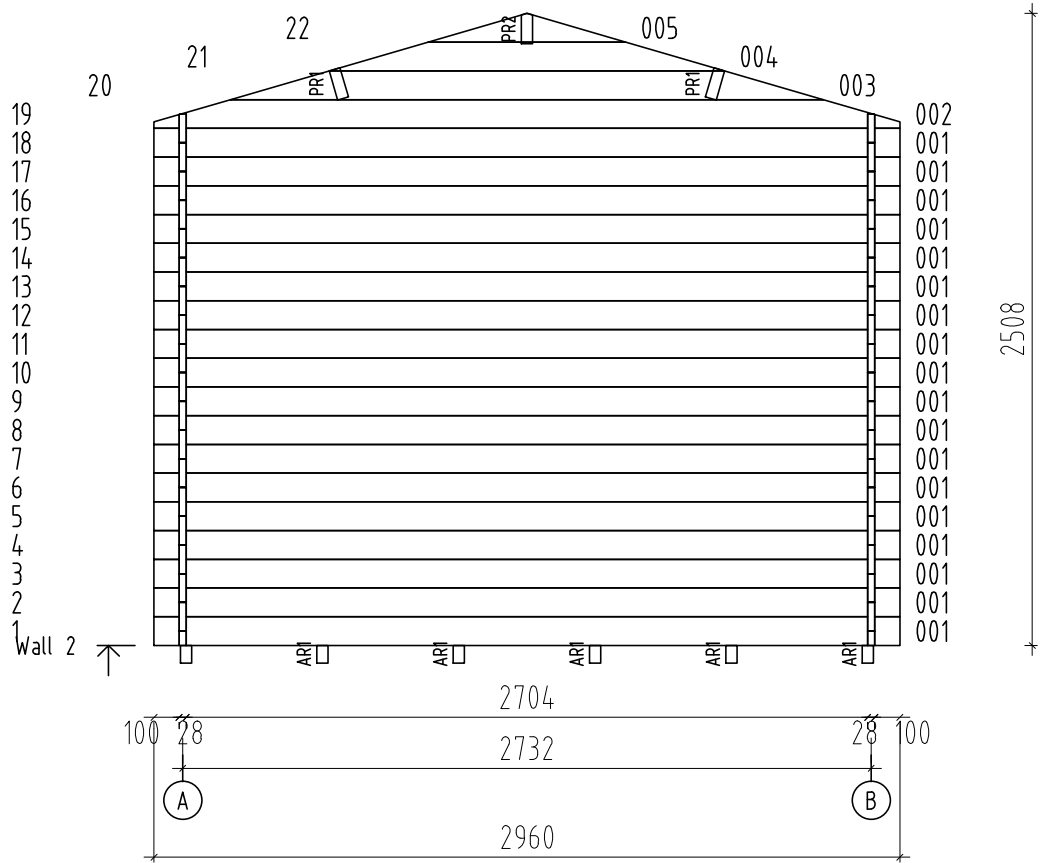

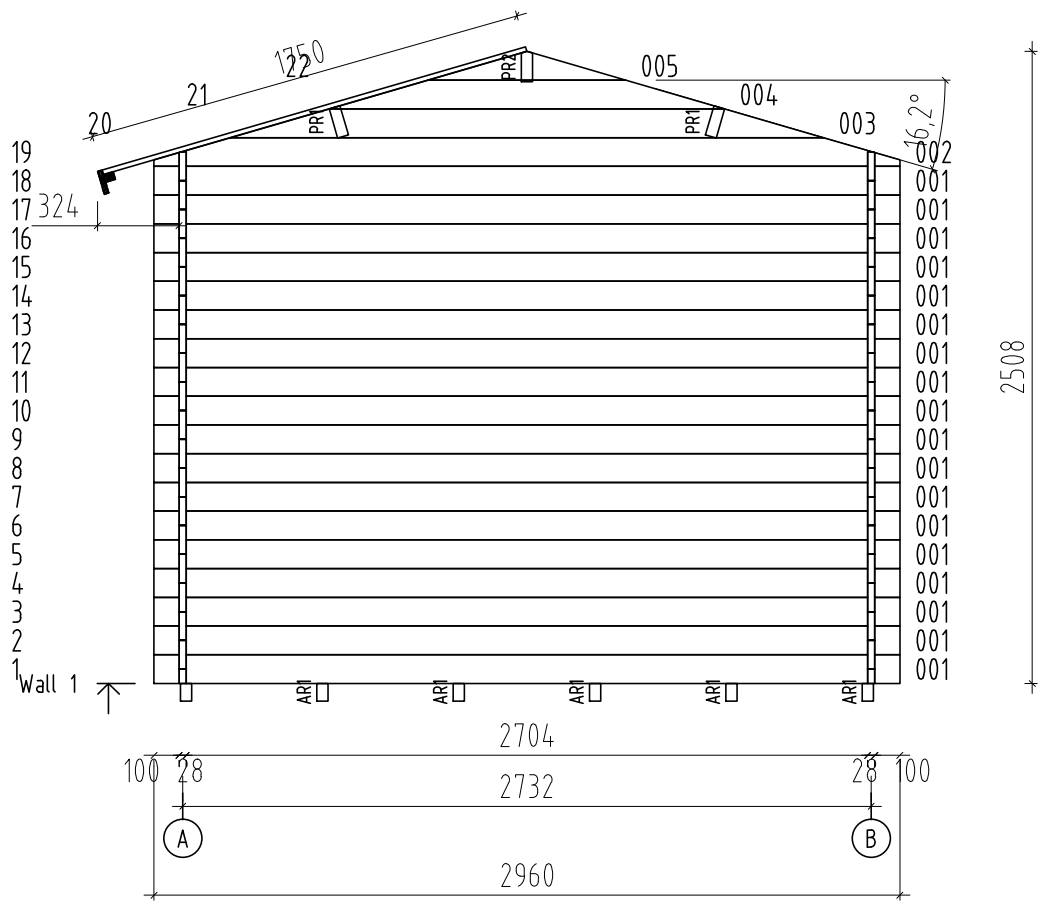

28x4.5
*

4.5x70

5x90

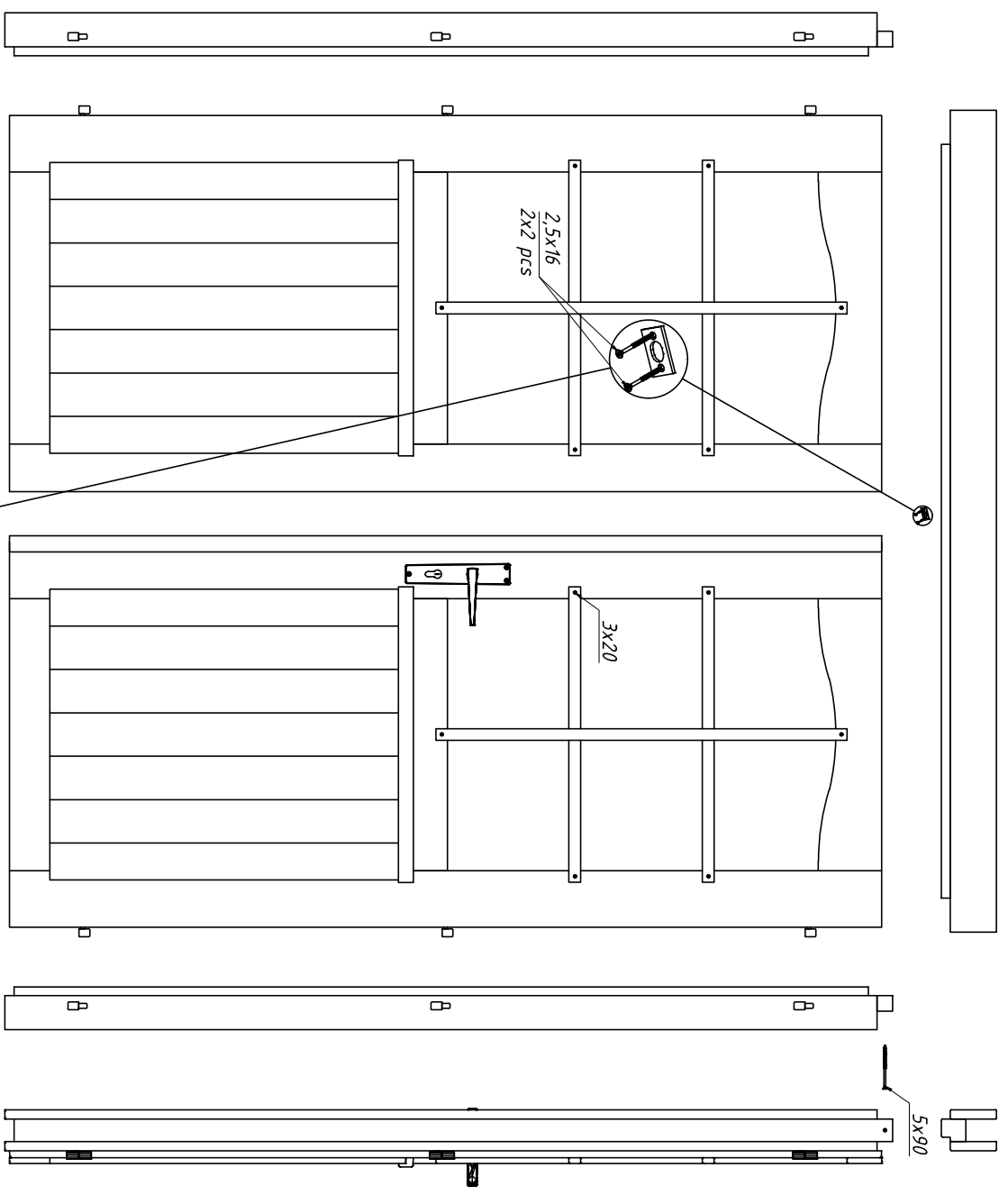

5x90

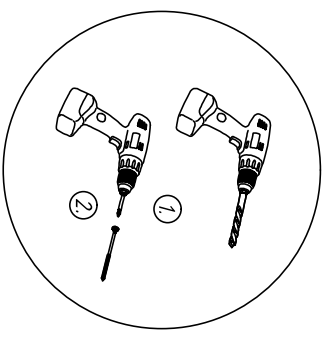

- * The specification may vary depending on the specific model.
- * Die Spezifikation können je nach Modell unterschiedlich sein.
- * Les spécifications peuvent varier selon le modèle spécifique.
- * Dependiendo del modelo, la especificación puede cambiar.
- * Le specifiche possono variare a seconda del modello.
- * Tekniset tiedot voivat vaihdella mallista riippuen.
- * Spezifikationen kan variera beroende på den specifika modellen.

5x90

5x90