

# Installation manual

Montageanleitung • Notice de montage • Istruzioni per il montaggio • Manual de montaje • Monteringsanvisning •  
Installatiegids • Montážní návod • Asennusohje • Installationsmanual • Instrukcja instalacji • Paigaldusjuhend

## Log cabin FR44-3857-1

Blockhaus • Maisonnette en poutres • Casa di travi • Casa de jardin • Anneks • Tuinhuis • Zahradní domek •  
Timmerstuga • Hirsimökki • Dom z bali • Freesprussmaja

Width 380 x Depth 570 cm









Breite/Tiefe • Largeur/Profondeur • Lunghezza/Profondità • Ancho/Profundidad • Bredde/Dybde • Breedte/Diepte  
• Šířka/Hloubka • Leveys/Pituus • Bredd/Längd • Szerokość/Głębokość • Laius/pikkus

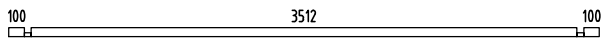
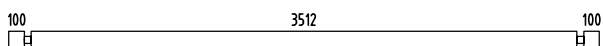
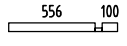
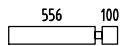
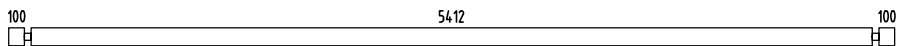
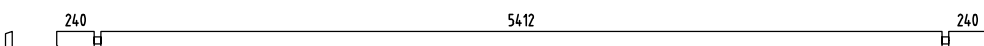
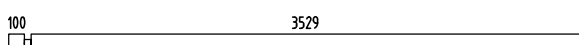
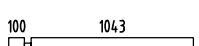
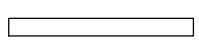
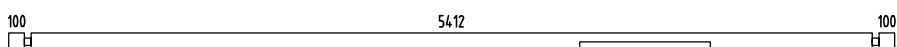
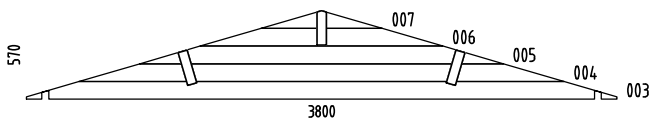
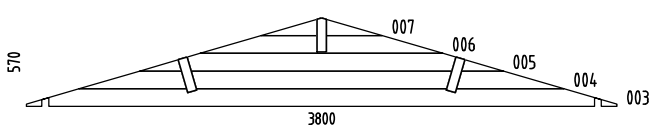
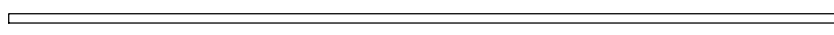
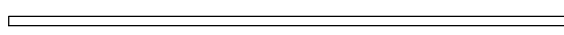
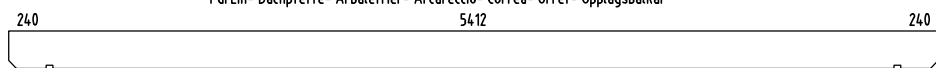
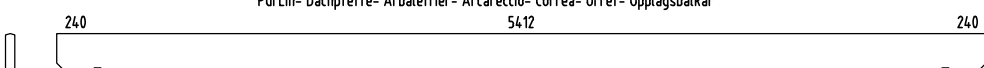







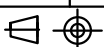

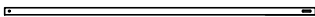
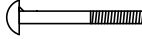
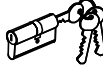

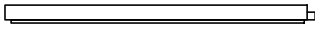
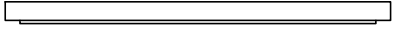

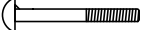

Log thickness 44 mm

Bohlenstärke • Épaisseur des murs • Spessore delle pareti • Grosor de pared • Tykkelse • Wanddicke • Tloušťka  
stěny • Seinän paksuus • Väggtjocklek • Grubość ścian • Seinapaksus



The producer shall have the right to make technical changes to the product • Technische Änderungen vorbehalten • Le  
producteur réserve le droit d'effectuer des modifications techniques au produit • Il produttore mantiene il diritto di apportare  
modifiche tecniche al prodotto • Reservado el derecho a modificaciones técnicas • Produsent forbeholder seg retten til å endre  
tekniske egenskaper ved produktet • Alle rechten en technische wijzigingen voorbehouden • Výrobce si vyhrazuje právo na  
technické změny výrobku • Valmistaja pidättää oikeuden tehdä tuotteeseen teknisiä muutoksia • Tillverkaren har rätt att utföra  
tekniska förändringar för produkten • Producent zastrzega sobie prawo do dokonywania zmian technicznych produktu • Tootja  
jätab endale õiguse muuta toote tehnilisi omadusi

Pos	SPECIFICATION-STÜCKLISTE-NOMENCLATURE-ELEMENTI-ESPECIFICACIÓN- MÄÄRITYS- SPECIFIKATION "FR44-3857-8"	Pcs	Profile (mm)	Length (mm)
001		1	44x57	3800
002		19	44x114	3800
008		2	44x57	700
009		34	44x114	700
010		19	44x114	5700
011		2	44x114	5980
012		7	44x114	3673
013		25	44x114	1187
014		9	44x114	1187
015		1	44x114	5700
W1-1		1		
W2-1		1		
AR1	Foundation- Fundament- Fondation- Fondazione- Vigas de cimentación- Perustus- Grund 	2	80x60	5330
AR2	Foundation- Fundament- Fondation- Fondazione- Vigas de cimentación- Perustus- Grund 	2	80x60	3590
PR1	PurLin- Dachpfette- Arbalétrier- Arcareccio- Correa- Orref- Upplagsbalkar 	2	60x240	5980
PR2	PurLin- Dachpfette- Arbalétrier- Arcareccio- Correa- Orref- Upplagsbalkar 	1	60x240	5980
RB2-1	Roof board- Dachbrett- Madrier du toit- Tavola tetto- Tabla de tejado- Kattolevyt- Takbrädor 	136	89x19	2200
Dia-1	Diamond- Deckbrett- Madrier- Tavola di copertura- Rombo- Vinonellö- Diamant 	2	19x140	300
EaE1-1	Eave edging- Dachrandbrett- Madrier en bordure du toit- Tavola bordo tetto- Tabla de valadizo- Rästsläppla- Taklist 	4	16x95	2990
FaB3-1	Facia board- Giebelblende- Écran frontal- Schermo frontone- Tabla de facia- Rästsläppla aaltoileva- Röstläkt vågig 	4	16x120	2240
RE2-1	Roof edge reinforcement- Dachrandleiste- Baguette en bordure du toit- Rinforzo bordo tetto- Refuerzo borde tejado- Kattoreunan vahvistus- Takkantförstärkning 	2	32x40	2480
RE2-2	Roof edge reinforcement- Dachrandleiste- Baguette en bordure du toit- Rinforzo bordo tetto- Refuerzo borde tejado- Kattoreunan vahvistus- Takkantförstärkning 	2	32x40	3500
QT18-1	Seal- Gummidichtung- Joint d'isolation- Guarnizione- Burlete- Tiiviste- Tätning 	2	TA44-21V U44-24V	5000
	Object name "FR44-3857-8"			Page 1/3

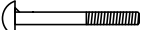
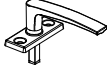
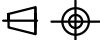
Pos	SPECIFICATION-STÜCKLISTE-NOMENCLATURE-ELEMENTI-ESPECIFICACIÓN- MÄÄRITYS- SPECIFIKATION "FR44-3857-8"	Pcs	Profile (mm)	Length (mm)	
SiS5-1	Side slat - Randleiste - Baguette en bordure - Listello bordo 5- SivuListta- Sidolista		2	28x45	911
StB1-1	Storm brace- Sturmleiste- Protection contre le vent- Antivento- Protector contra tormentas- Myrskytuki- Stormstöd		4	25x45	2100
Fim	-Fixing kit- Befestigungsset- Moyens de fixation- Materiale di fissaggio- Kit de fijación- Kiinnityssarja- Infästningssats		1	USE	
QP0YP8x 80Zn	Bolt -Schloss-schraube -Boulon- Bullone- Perno- Pultti- Bult- M8x80mm		8	StB1-1	
QULSI30x 35	Cylinder- Zylinderschloss- Serrure a mortaiser- Serratura a cilindro- Bombin- Sylinteri- Cylinder		1	U44-24V	
KULEP-3 7	Detail- Detail- Detail- DettagLlo- Detalle- Yksityiskohta- Detalj- KULEP-37		1	W2	
KULEV-3 7	Detail- Detail- Detail- DettagLlo- Detalle- Yksityiskohta- Detalj- KULEV-37		1	W2	
KULEY-2 5	Detail- Detail- Detail- DettagLlo- Detalle- Yksityiskohta- Detalj- KULEY-25		1	W2	
QLIU KAPal	Door fittings- Türbeschlag- Ferrure- Ferramenta porta- Manilla puerta- Ovihelat- Dörrbeslag- QLIUKAPal		1	U44-24V	
QNU20x2 0x40	L-iron- Winkel- Angle -Angolo- Angulo- L-rauta- L-järn 20x20x40		2	002 (W2)	
QNU40x4 0x40Zn	L-iron- Winkel- Angle -Angolo- Angulo- L-rauta- L-järn 40x40x40		12	AR+wall; ...	
QNA2_2 x50Zn	Nail- Nagel- Clou- Chiodo- Clavo- Naula- Spik- 2.5x50mm		450	RB2-1	
QMUkk8 Zn	Nut- Schraubenmutter- Écrou- Dado- Tuerca- Mutteri- Mutter M8mm		8		
QKRPP3 _5x40Zn	Screw- Schraube- Vis- Vite- Tornillo- Ruuvi- Skruv- 3.5x40mm		100		
QKRPP3x 20Zn	Screw- Schraube- Vis- Vite- Tornillo- Ruuvi- Skruv- 3x20mm		18	U44-24L; TA44-21V	
QKRPP4 _5x50Zn	Screw- Schraube- Vis- Vite- Tornillo- Ruuvi- Skruv- 4.5x50mm		80	KULENGx+KULEY-25 EaE1-1; FaB3-1; RE2; ...	
QKRPP4 _5x70Zn	Screw- Schraube- Vis- Vite- Tornillo- Ruuvi- Skruv- 4.5x70mm		40	001; 008; 011; SiS5-1; ...	
QKRPP5x 90Zn	Screw- Schraube- Vis- Vite- Tornillo- Ruuvi- Skruv- 5x90mm		4	KULEY-25	
QKRPP6x 120Zn	Screw- Schraube- Vis- Vite- Tornillo- Ruuvi- Skruv- 6x120mm		10	ARx; PRx	
QSE8x22 Zn	Washer- Dichtscheibe- Joint- Rondella- Arandela- Aluslevy- Bricka 8x22mm		8		
QLIA	Window fittings- Fenstergriff- Poigne de la fenêtre- Maniglia finestra- Manilla (ventana)- Ikkunahelat- Fönsterbeslag		1	TA44-21V	
	Object name "FR44-3857-8"		Page 2/3		



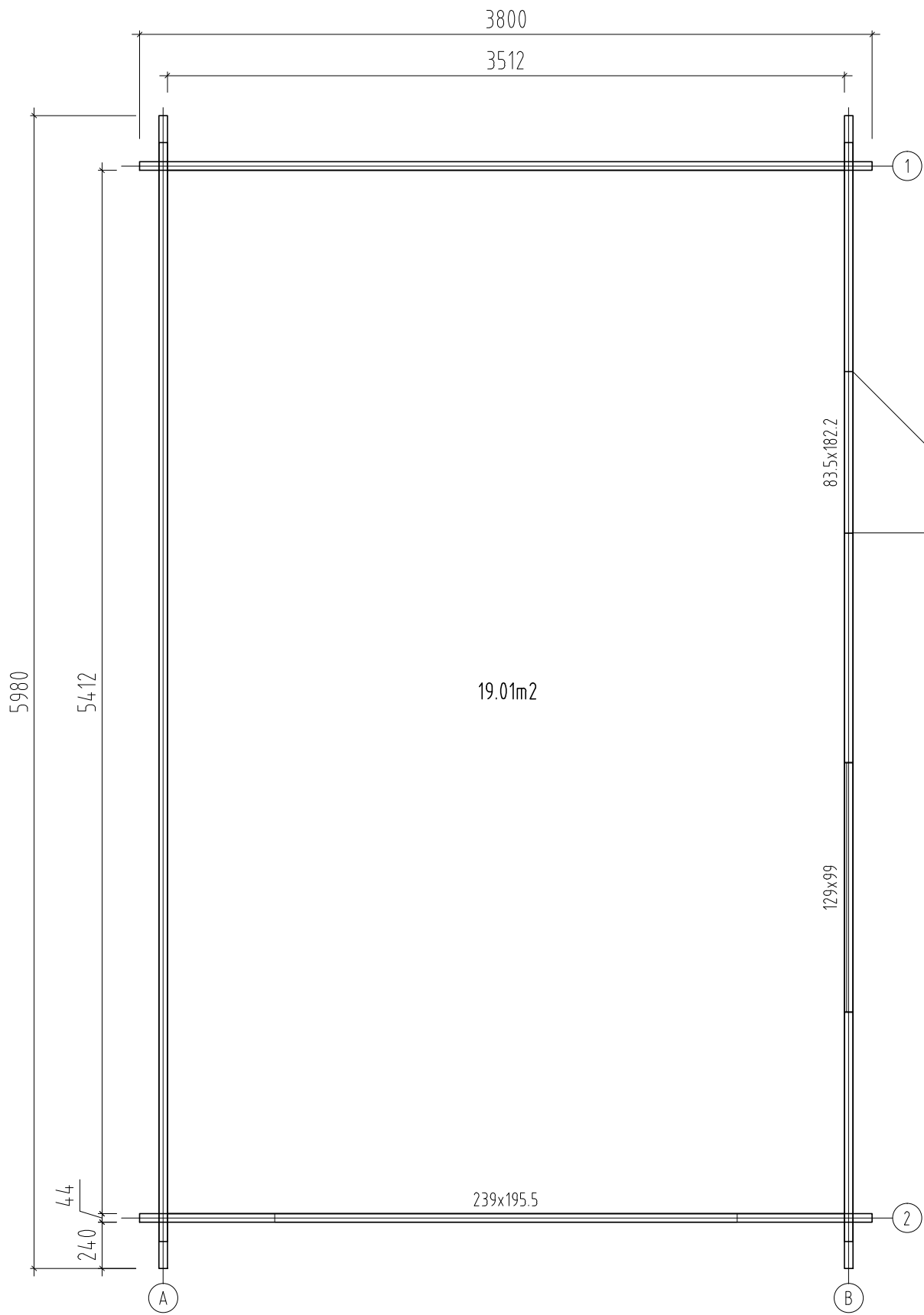

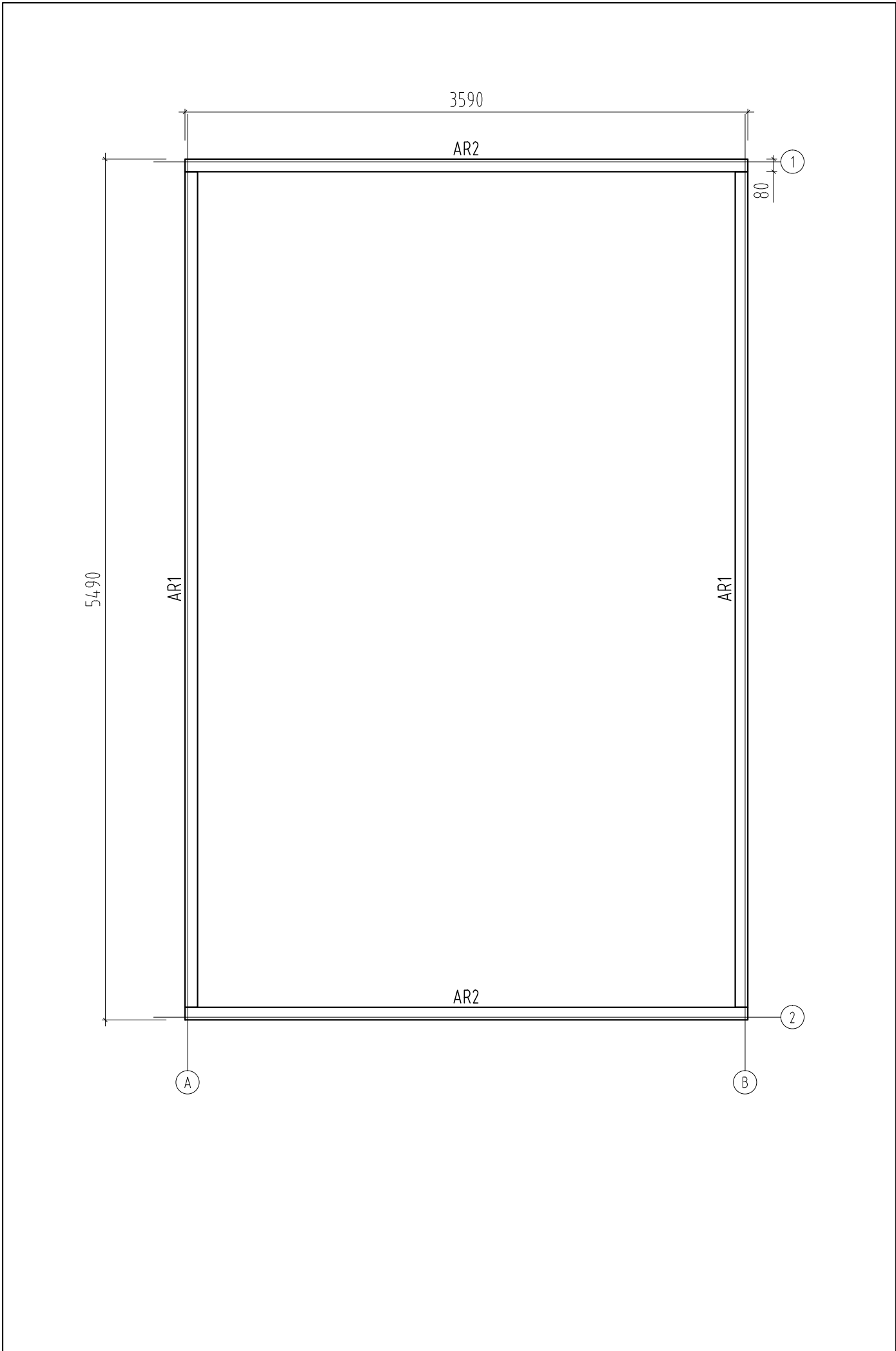



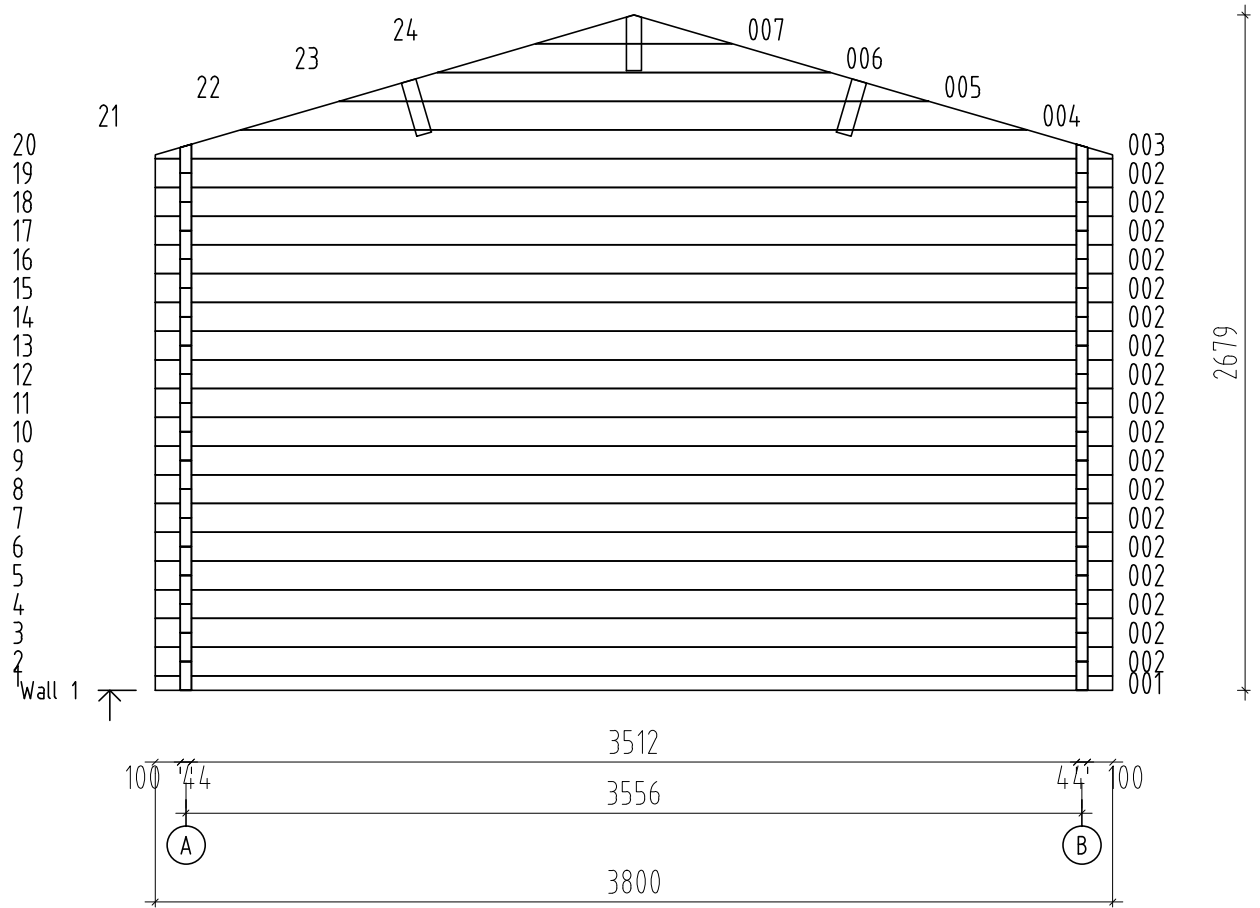



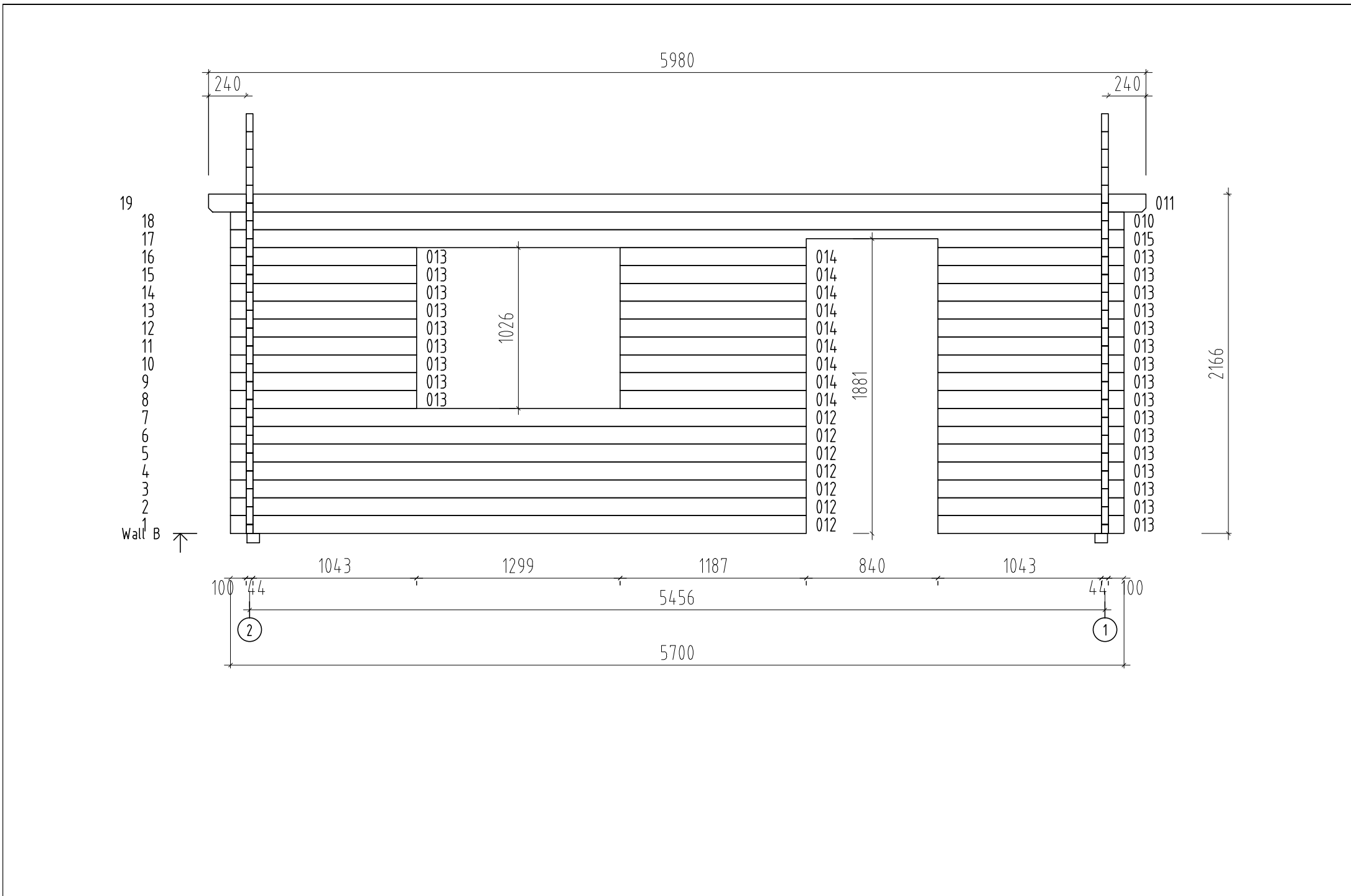

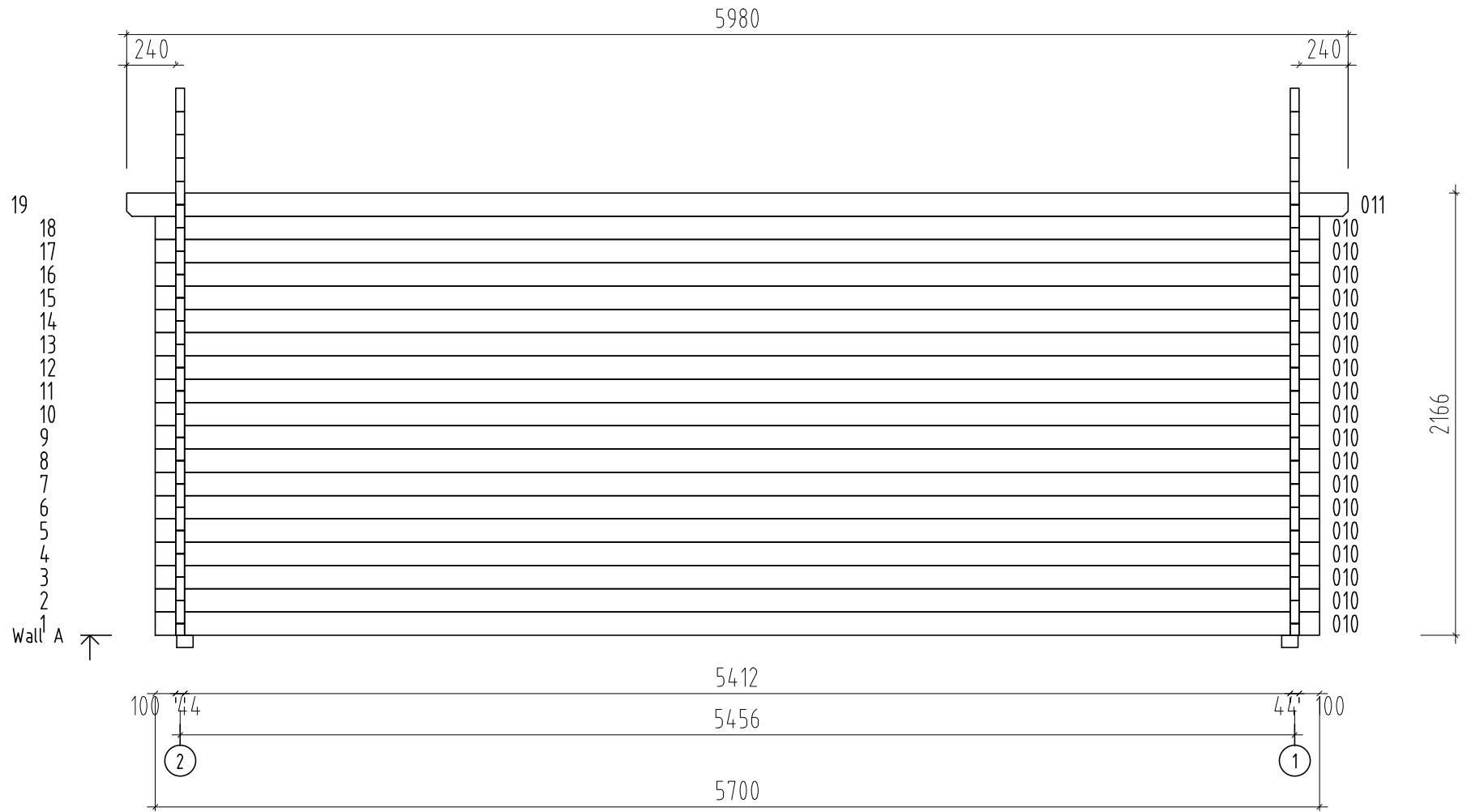

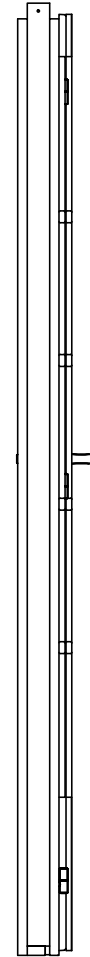
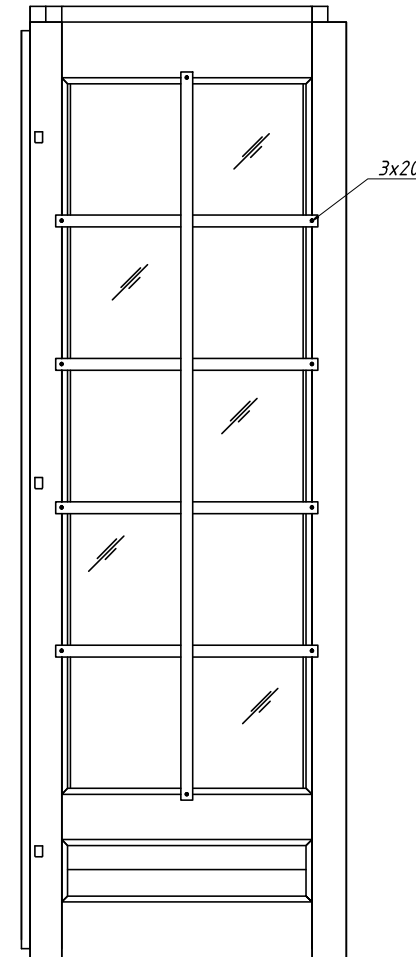
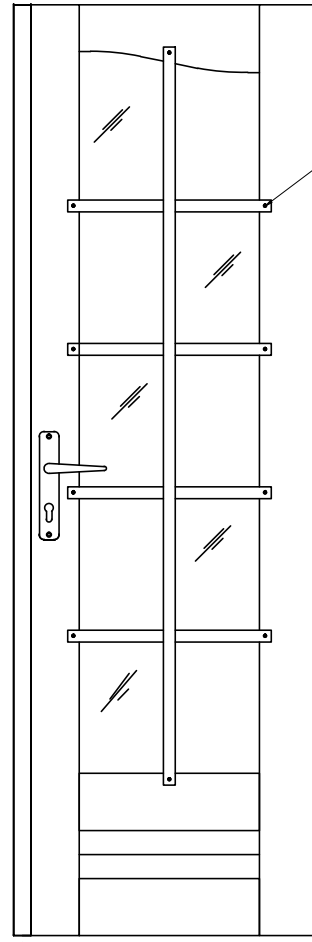
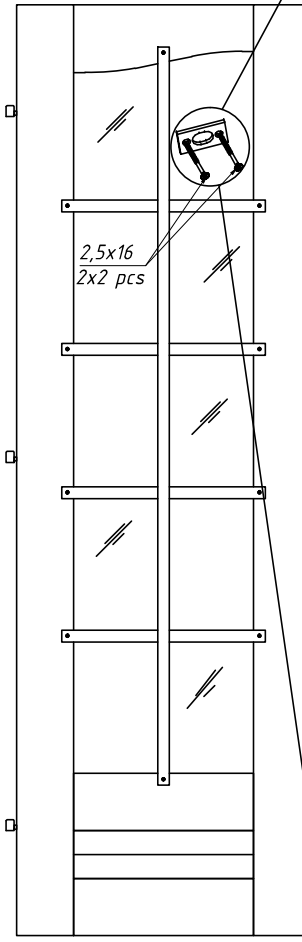
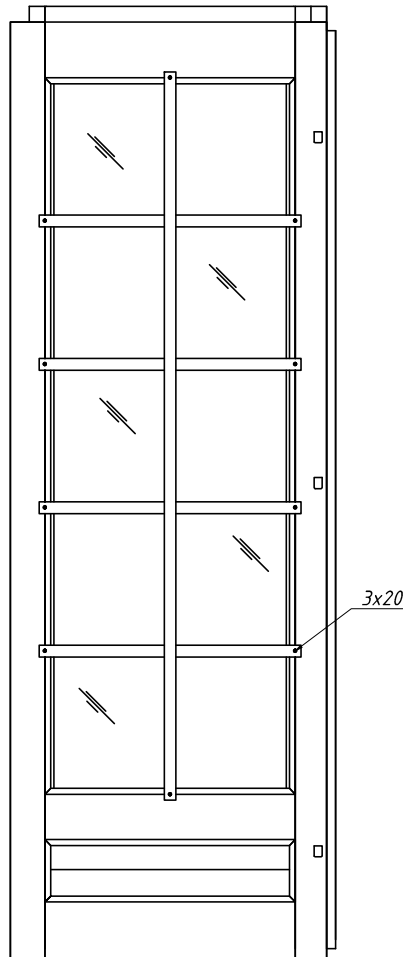
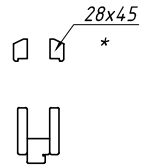
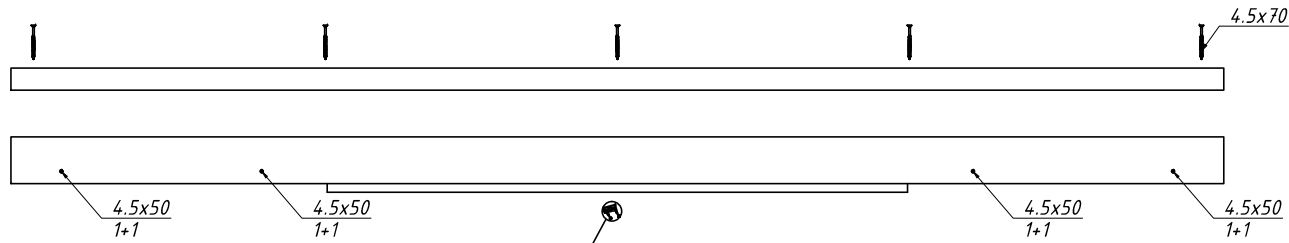
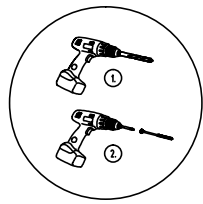

4.5x50

4.5x50

\* The specification may vary depending on the specific model

\* Die Spezifikation können je nach Modell unterschiedlich sein

\* Les spécifications peuvent varier selon le modèle spécifique

\* Dependiendo del modelo, la especificación puede cambiar

\* Le specifiche possono variare a seconda del modello



