

# Installation manual

Montageanleitung • Notice de montage • Istruzioni per il montaggio • Manual de montaje • Monteringsanvisning •  
Installatiegids • Montážní návod • Asennusohje • Installationsmanual

## Log cabin FR44-5032

Blockhaus • Maissonette en poutres • Casa di travi • Casa de jardin • Anneks • Tuinhuis • Zahradní domek •  
Timmerstuga • Hirsimökki

Width 500 x Depth 320 cm











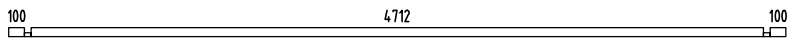
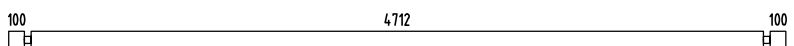
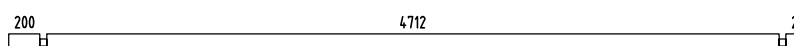
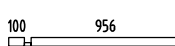
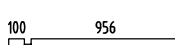
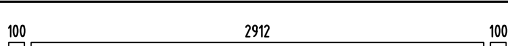
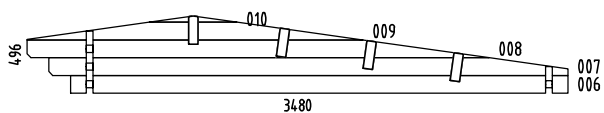
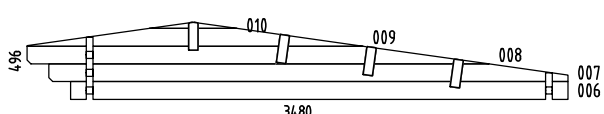
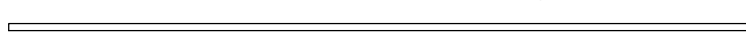
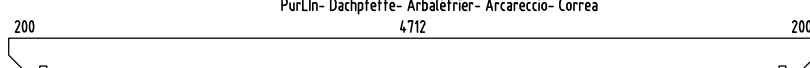
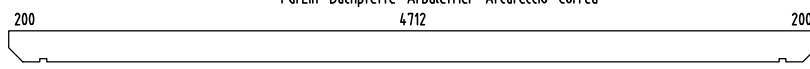

Breite/Tiefe • Largeur/Profondeur • Lunghezza/Profondità • Ancho/Profundidad • Bredde/Dybde • Breedte/Diepte  
• Šířka/Hloubka • Leveys/Pituus • Bredd/Längd

Log thickness 44 mm









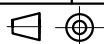

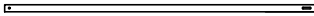
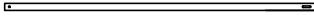

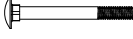
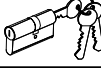



Bohlenstärke • Épaisseur des murs • Spessore delle pareti • Grosor de pared • Tykkelse • Wanddicke • Tloušťka  
stěny • Seinän paksuus • Väggtjocklek

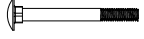

The producer shall have the right to make technical changes to the product • Technische Änderungen vorbehalten • Le  
producteur réserve le droit d'effectuer des modifications techniques au produit • Il produttore mantiene il diritto di apportare  
modifiche tecniche al prodotto • Reservado el derecho a modificaciones técnicas • Produsent forbeholder seg retten til å endre  
tekniske egenskaper ved produktet • Alle rechten en technische wijzigingen voorbehouden • Výrobce si vyhrazuje právo na  
technické změny výrobku • Valmistaja pidättää oikeuden tehdä tuotteeseen teknisiä muutoksia • Tillverkaren har rätt att utföra  
tekniska förändringar för produkten

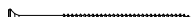
Pos	SPECIFICATION-STÜCKLISTE-NOMENCLATURE-ELEMENTI-ESPECIFICACIÓN FR44-5032	Pcs	Profile (mm)	Length (mm)
001		1	44x57	5000
002		19	44x114	5000
003		2	44x114	5200
004		2	44x57	1100
005		34	44x114	1100
006		34	44x114	3200
WA-1		1		
WB-1		1		
AR1	Foundation- Fundament- Fondation- Fondazione- Vigas de cimentación 	6	70x45	4790
PR1	PurlIn- Dachpfette- Arbalétrier- Arcareccio- Correa 	3	60x200	5200
PR2	PurlIn- Dachpfette- Arbalétrier- Arcareccio- Correa 	1	60x200	5200
FB2-1	Floor board- Fussbodenbrett- Madrier du plancher - Tavola pavimento- Tabla de suelo 	53	89x19	2905
RB2-1	Roof board- Dachbrett- Madrier du toit- Tavola tetto- Tabla de tejado 	59	89x19	2600
RB2-2	Roof board- Dachbrett- Madrier du toit- Tavola tetto- Tabla de tejado 	59	89x19	1180
Dia-1	Diamond- Deckbrett- Madrier- Tavola di copertura- Rombo 	2	19x140	300
EaE1-1	Eave edging- Dachrandbrett- Madrier en bordure du toit- Tavola bordo tetto- Tabla de valadizo 	4	16x95	2600
FaB3-1	Facia board- Giebelblende- Écran frontal- Schermo frontone- Tabla de facia 	2	16x120	1220
FaB3-2	Facia board- Giebelblende- Écran frontal- Schermo frontone- Tabla de facia 	2	16x120	2640
FIB2-1	Floor beading- Fussbodenleiste- Baguette du plancher- Llistello pavimento- Listón de suelo 	8	19x19	2000
RE2-1	Roof edge reinforcement- Dachrandleiste- Baguette en bordure du toit- Rinforzo bordo tetto- Refuerzo borde tejado 	2	32x40	2250
RE2-2	Roof edge reinforcement- Dachrandleiste- Baguette en bordure du toit- Rinforzo bordo tetto- Refuerzo borde tejado 	2	32x40	2950
Sis1-1	Side slat- Randleiste- Baguette en bordure- Llistón de borde- Llistello bordo 	4	19x70	1917
Sis2-1	Side slat- Randleiste- Baguette en bordure- Llistón de borde- Llistello bordo 	2	19x95	2892

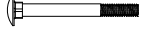

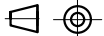
Pos	SPECIFICATION-STÜCKLISTE-NOMENCLATURE-ELEMENTI-ESPECIFICACIÓN FR44-5032	Pcs	Profile (mm)	Length (mm)
SlA11-1	Slat- Leiste- Baguette- Listello- Listón 	1	19x58	2800
StB1-1	Storm brace- Sturmleiste- Protection contre le vent- Antivento- Protector contra tormentas 	2	25x45	2050
StB1-2	Storm brace- Sturmleiste- Protection contre le vent- Antivento- Protector contra tormentas 	2	25x45	2250
Fim	-Fixing kit- Befestigungsset- Moyens de fixation- Materiale di fissaggio- Kit de fijación 	1	USE	
QP0YP8x80Zn	Bolt -Schloss-schraube -Boulon- Bullone- Perno- M8x80mm PUP0 	8	StB1-1; StB1-2	
QULSI30x35	Cylinder- Zylinderschloss- Serrure a mortaiser- Serratura a cilindro- Bombin- 30.35 	1	TU44-90P	
QLIU KAPal	Door fittings- Türbeschlag- Ferrure- Ferramenta porta- Manilla puerta- QLIUKAPal 	1	TU44-90P	
QNA1 4x40Me	Nail- Nagel- Clou- Chiodo- Clavo- 1.4x40mm 	60	FIB2-1	
QNA2 2x50Zn	Nail- Nagel- Clou- Chiodo- Clavo- 2.5x50mm 	350	FB2-1	
QNA3x70Zn	Nail- Nagel- Clou- Chiodo- Clavo- 3x70mm 	450	RB2-1x	
QMUKK8Zn	Nut- Schraubenmutter- Écrou- Dado- Tuerca- M8mm 	8		
QKRPP4 5x50Zn	Screw- Schraube- Vis- Vite- Tornillo- 4.5x50mm 	140	TU44-90P; Dia-1; EaE1-1; FaB3-1; ...	
QKRPP4 5x70Zn	Screw- Schraube- Vis- Vite- Tornillo- 4.5x70mm 	20	001; 003; 004	
QKRPP5x90Zn	Screw- Schraube- Vis- Vite- Tornillo- 5x90mm 	8	TU44-90P	
QKRPP6x120Zn	Screw- Schraube- Vis- Vite- Tornillo- 6x120mm 	16	PRx	
QSE8x22Zn	Washer- Dichtscheibe- Joint- Rondella- Arandela- 8x22mm 	8		
QHA150Zn	Hook- Haken- Crochet- Ganzio- Pestillo QHA150Zn 	2	TU44-90P +WALL	
	Object name FR44-5032		Page 2/2	



H = 1.500 m  
TOTAL: 13.72 m<sup>2</sup>

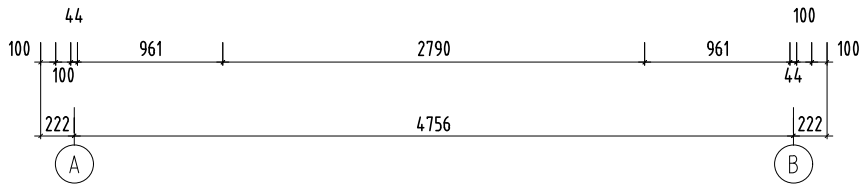
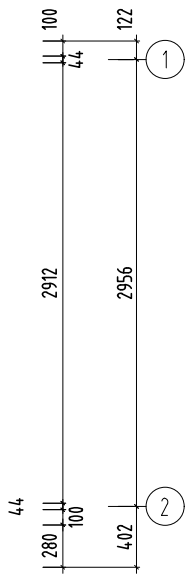
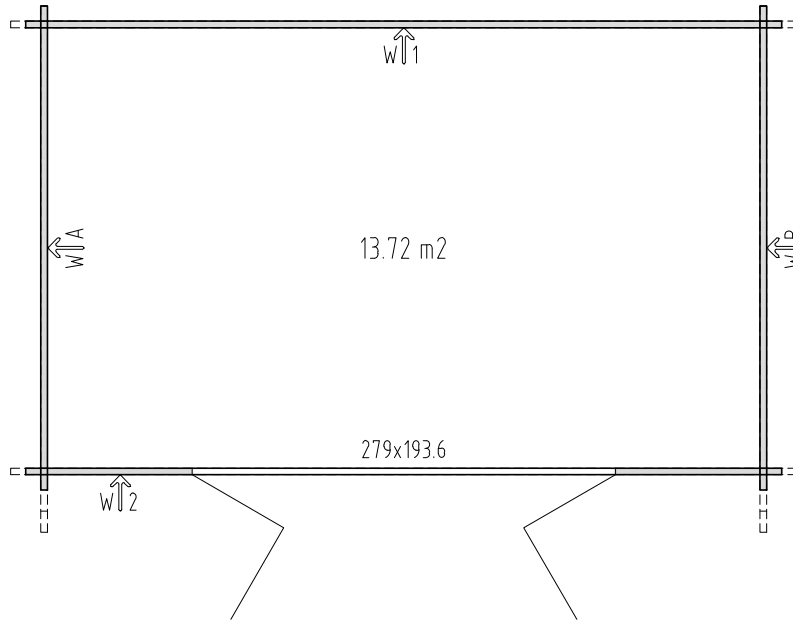
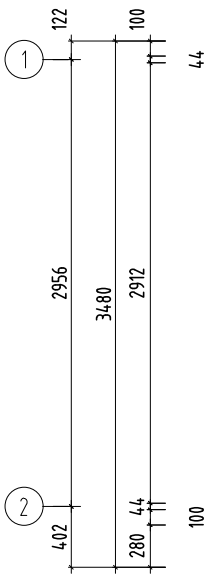
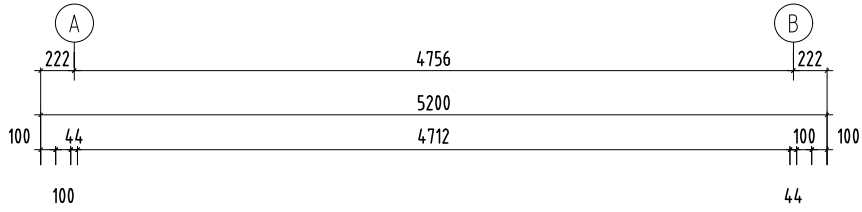

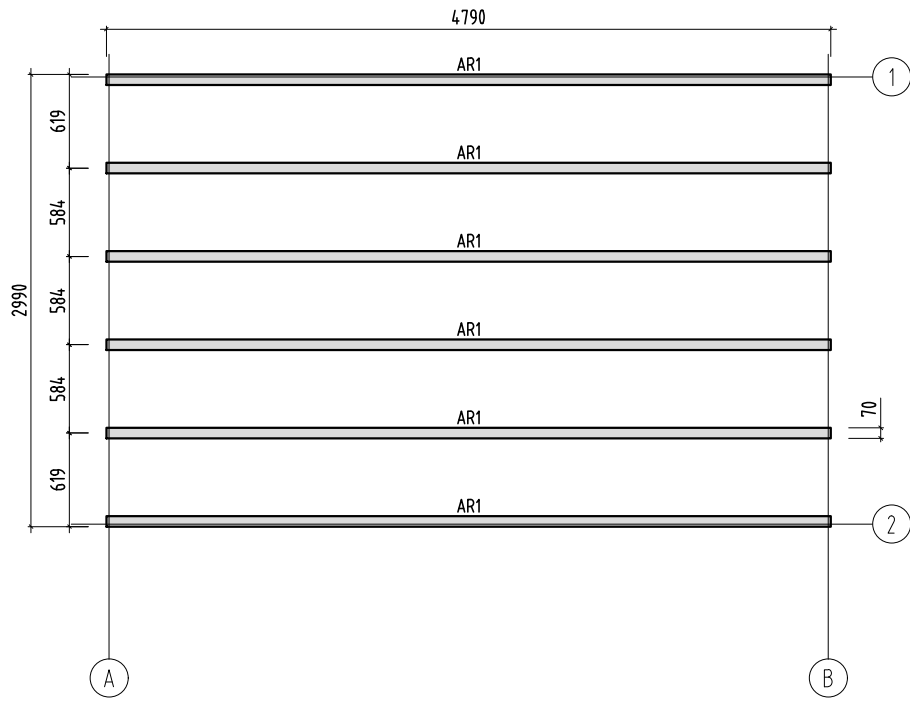

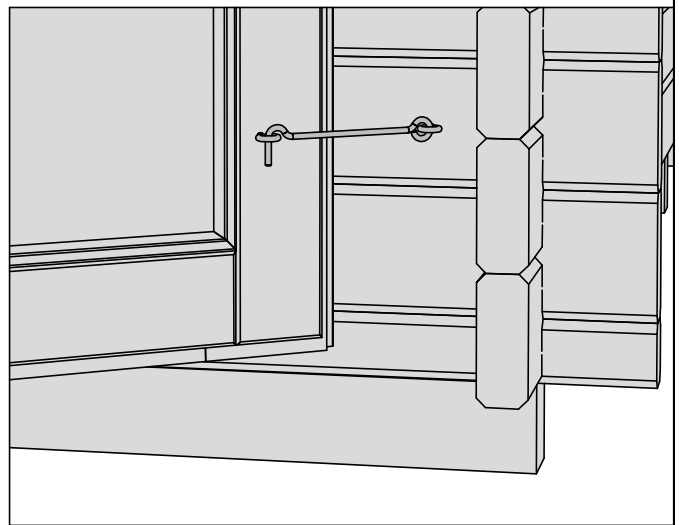
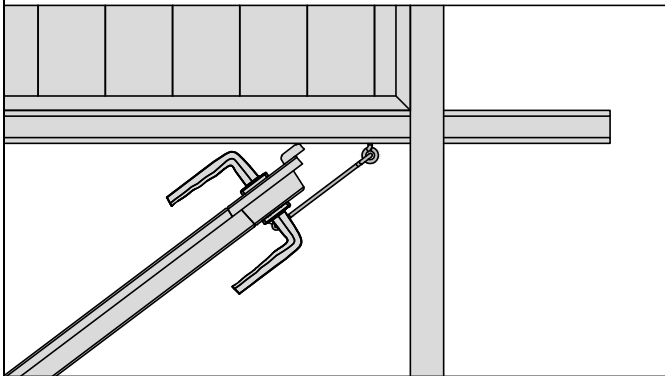
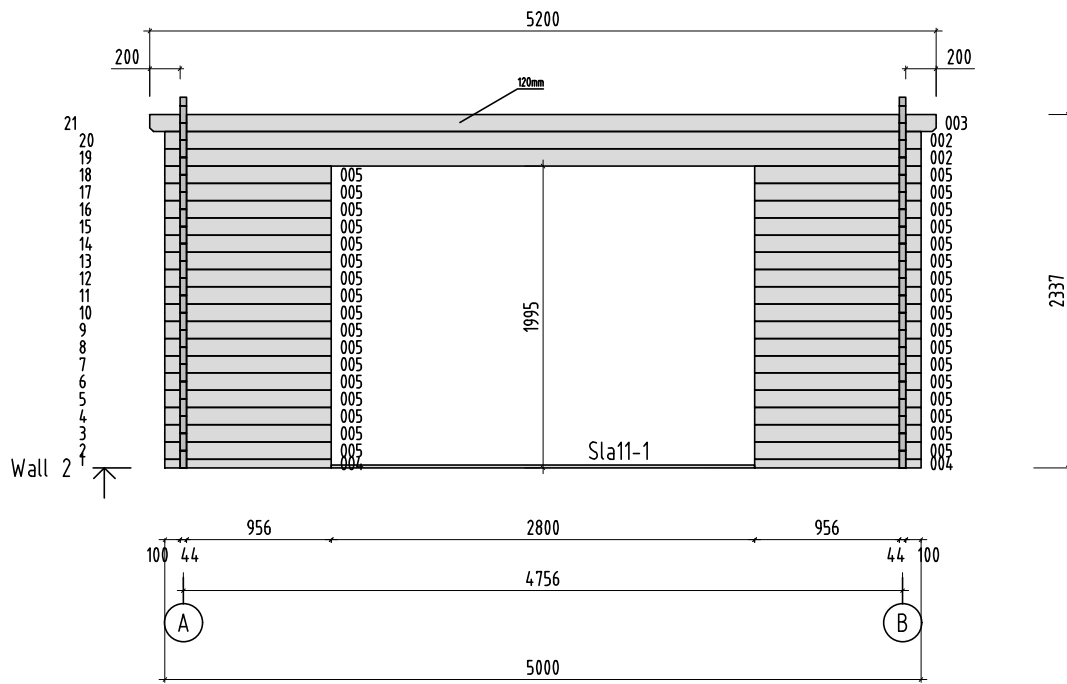

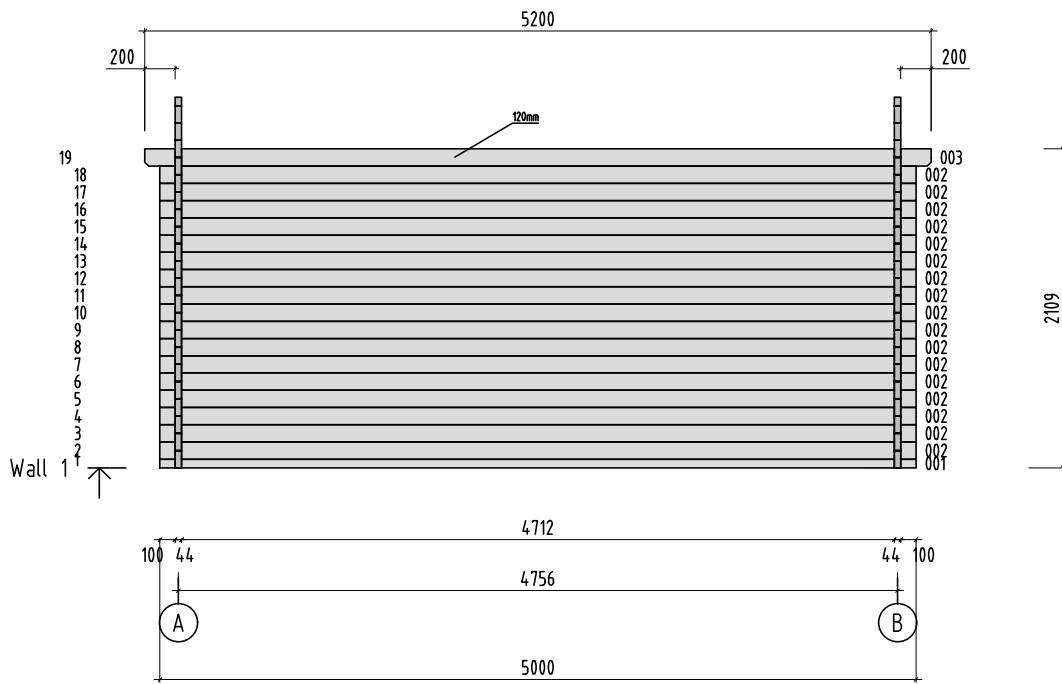



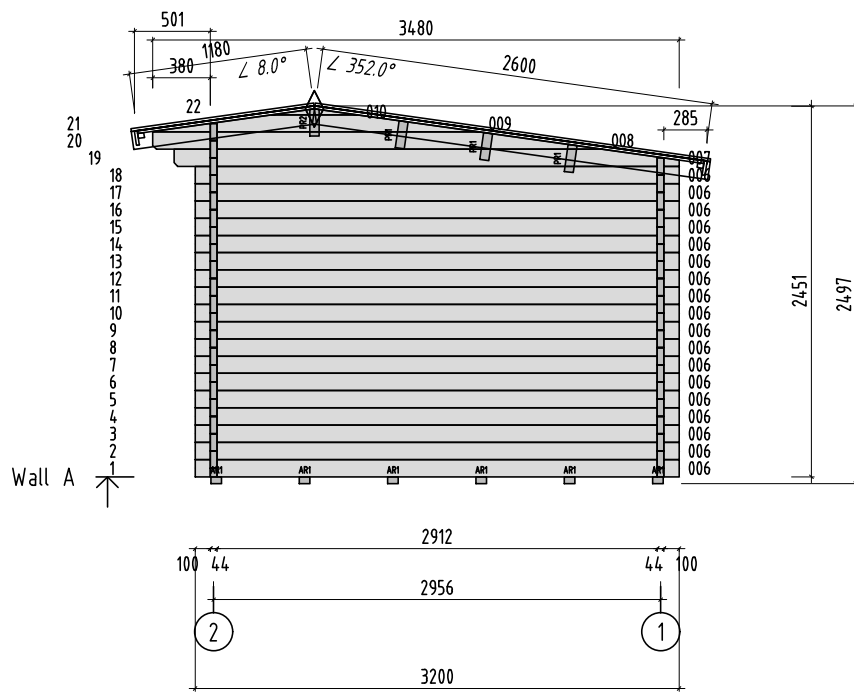

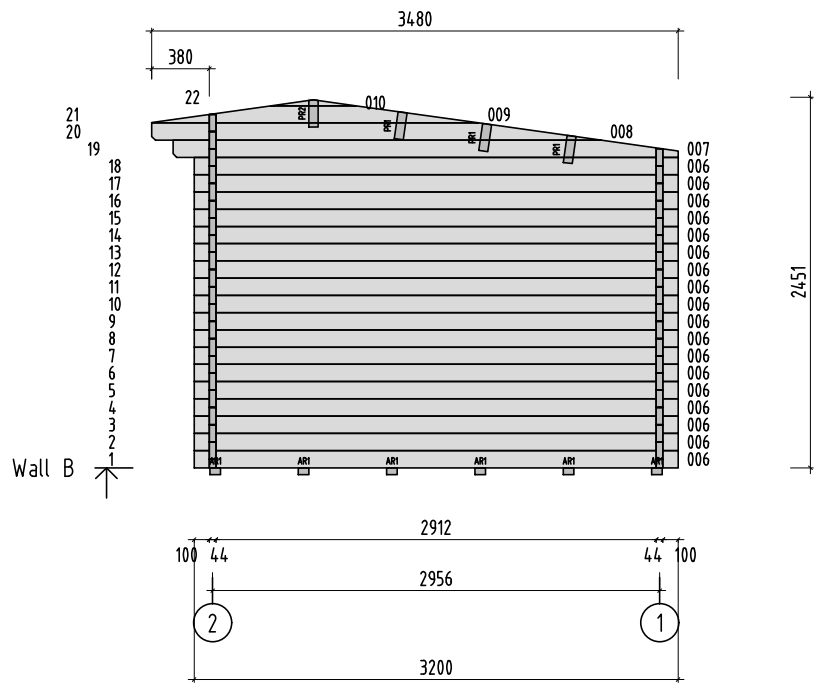

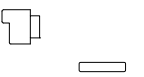
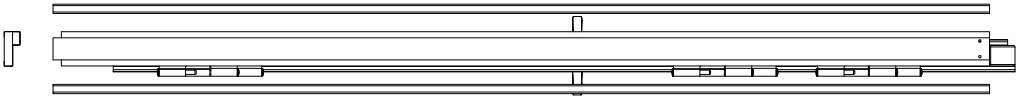
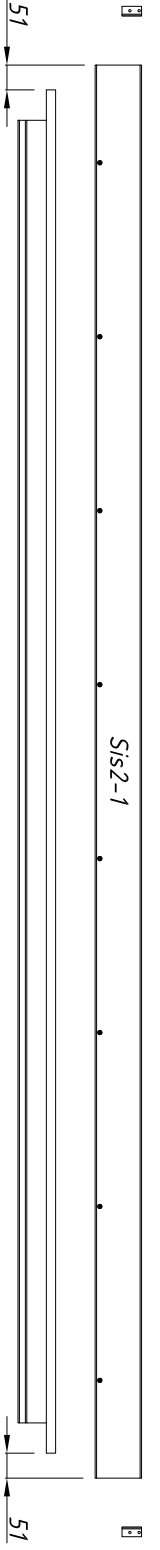
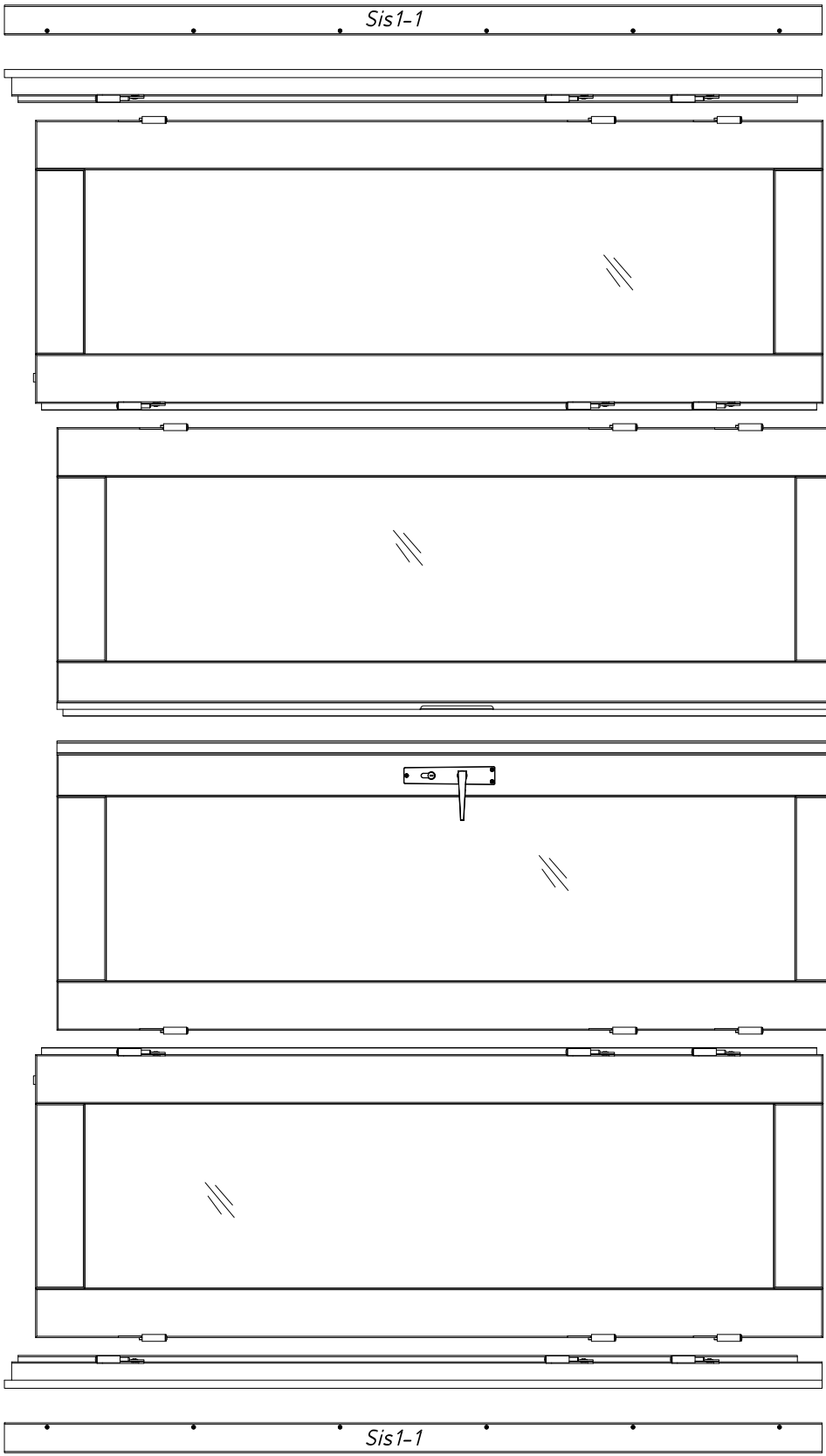
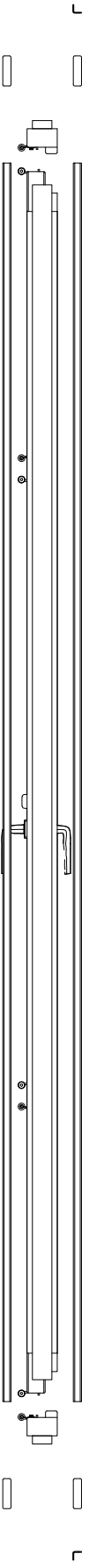

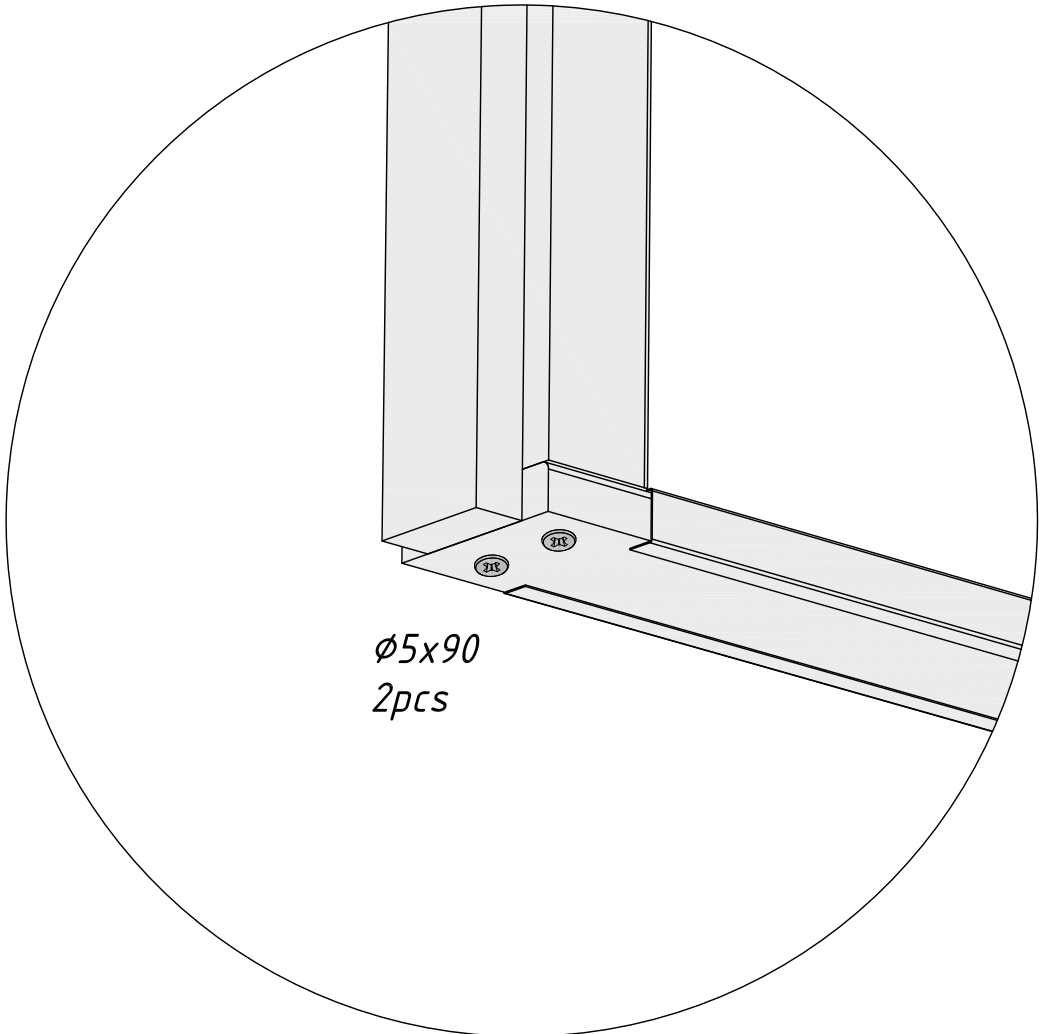
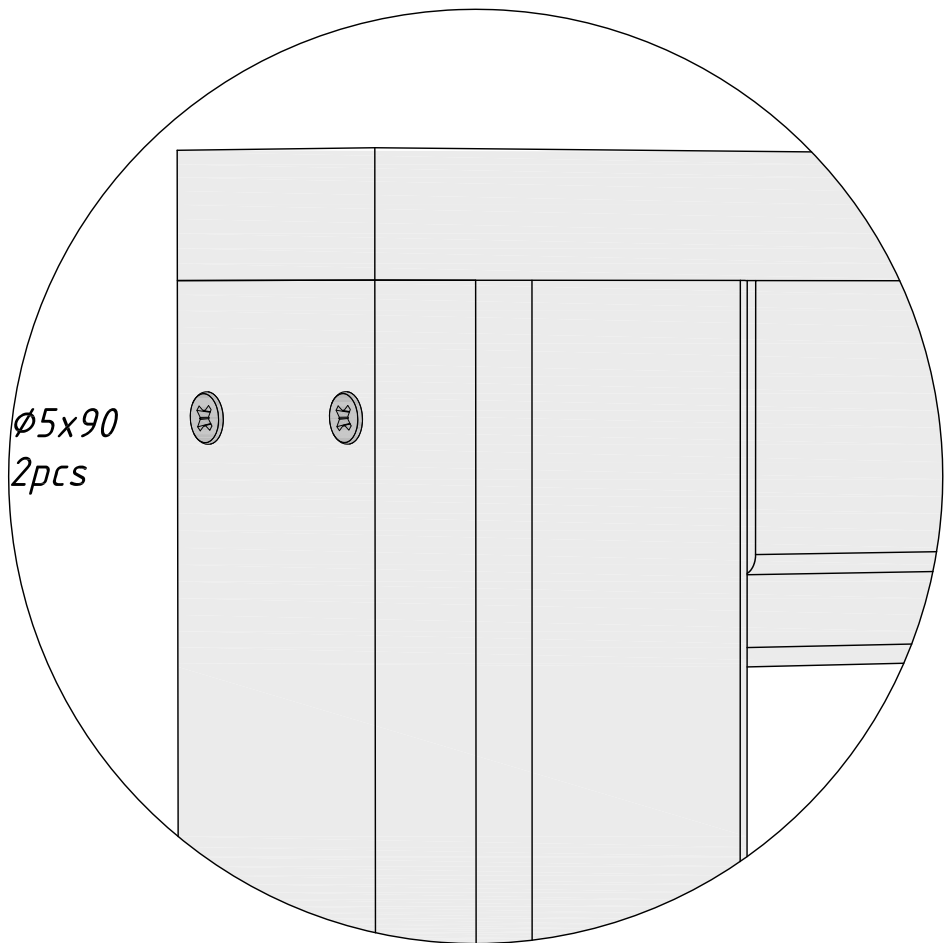

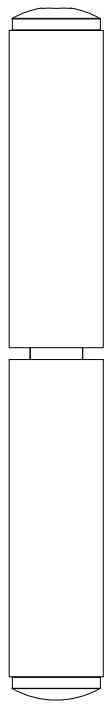
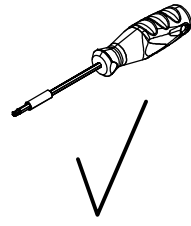
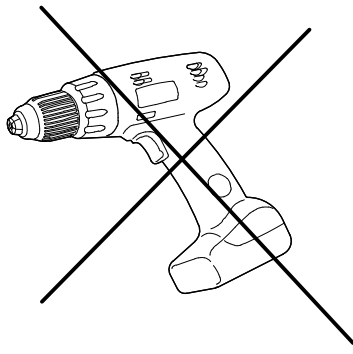

1.

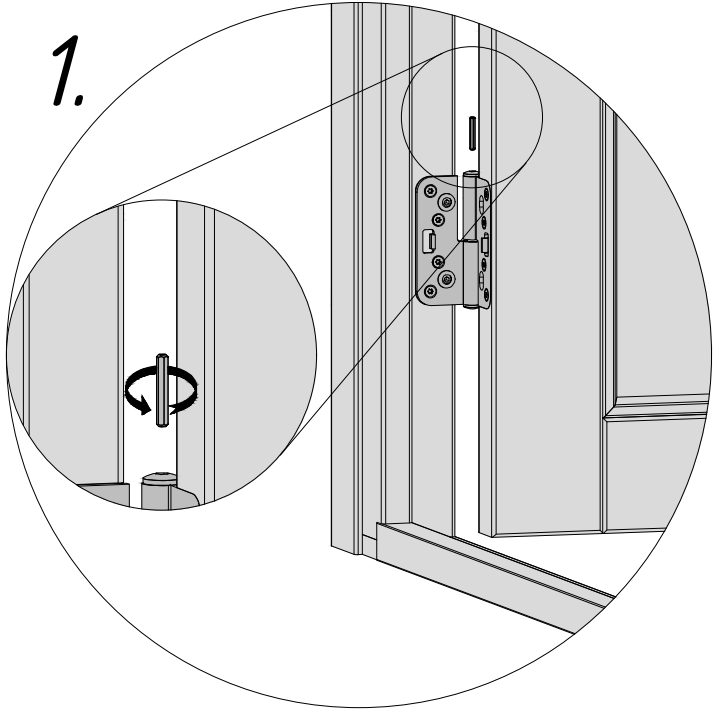

2.

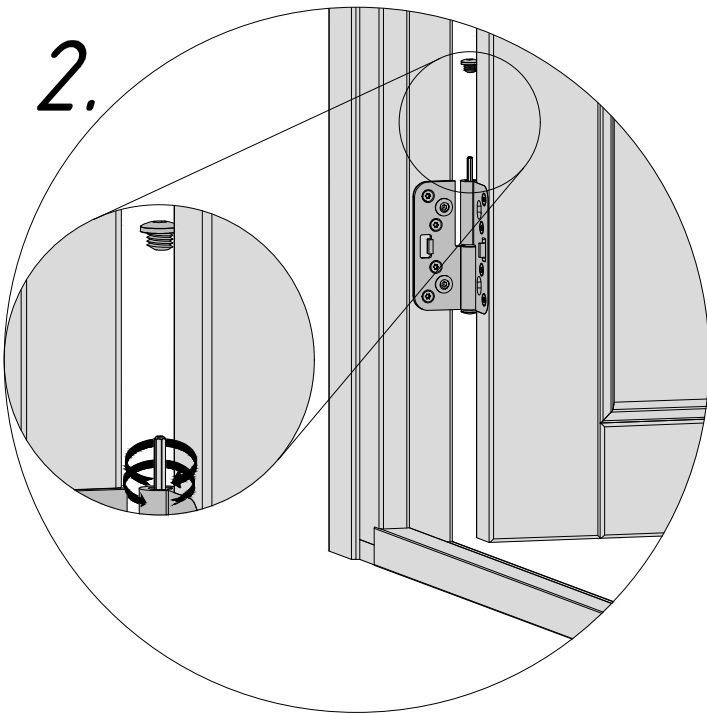

3.

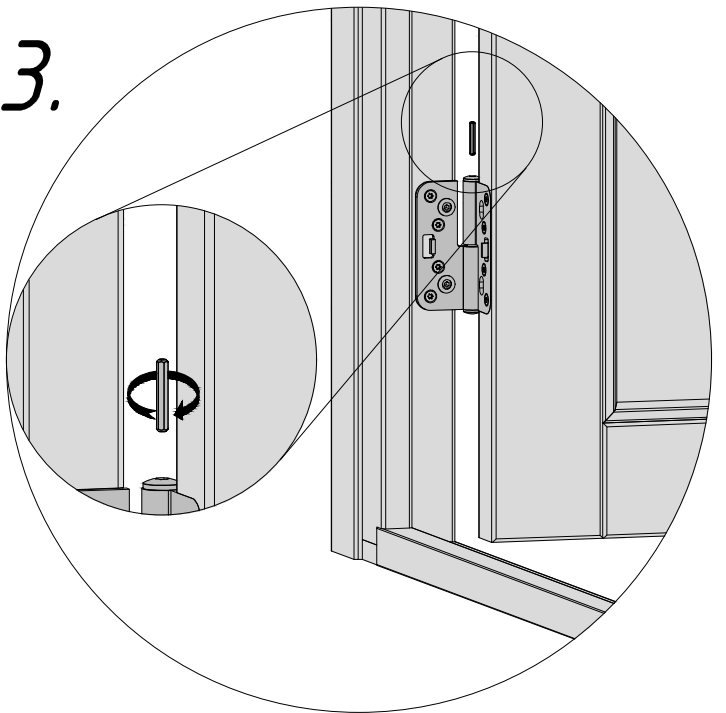

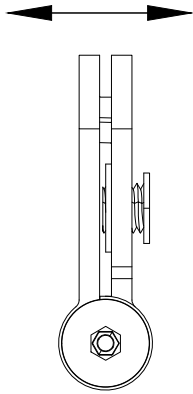
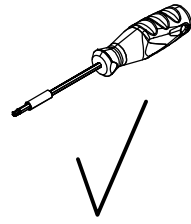
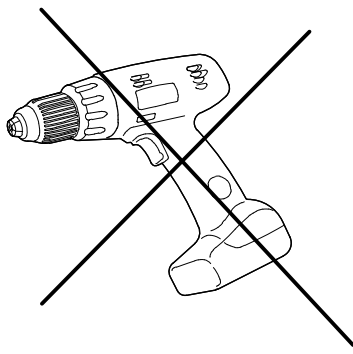

1.

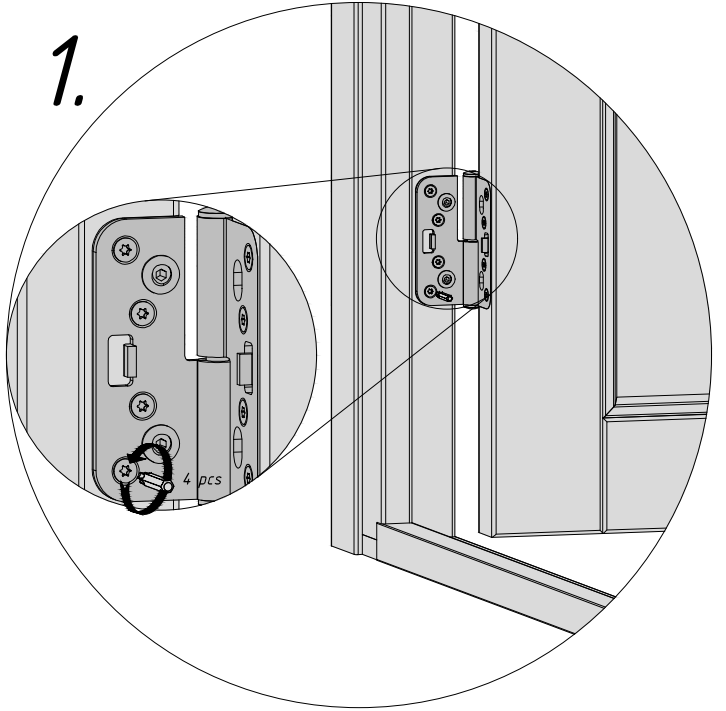

2.

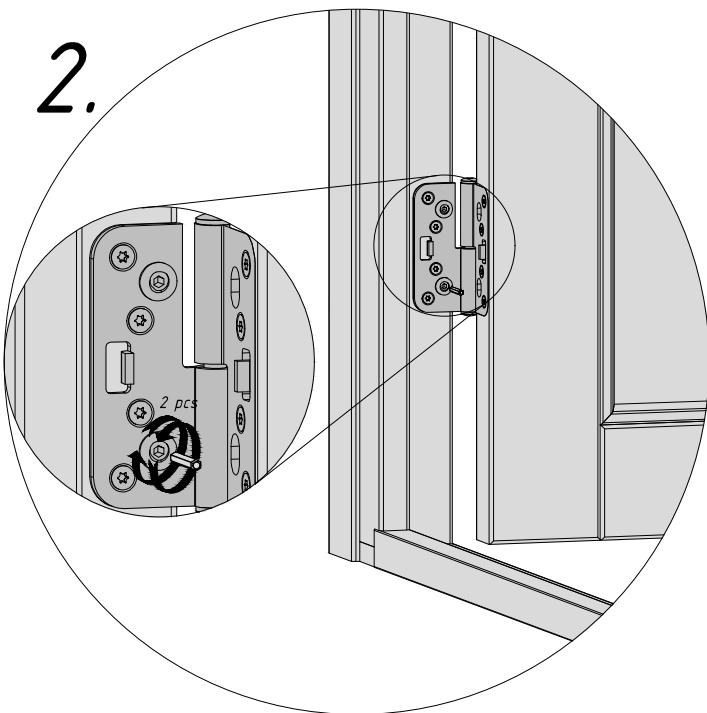

3.

