

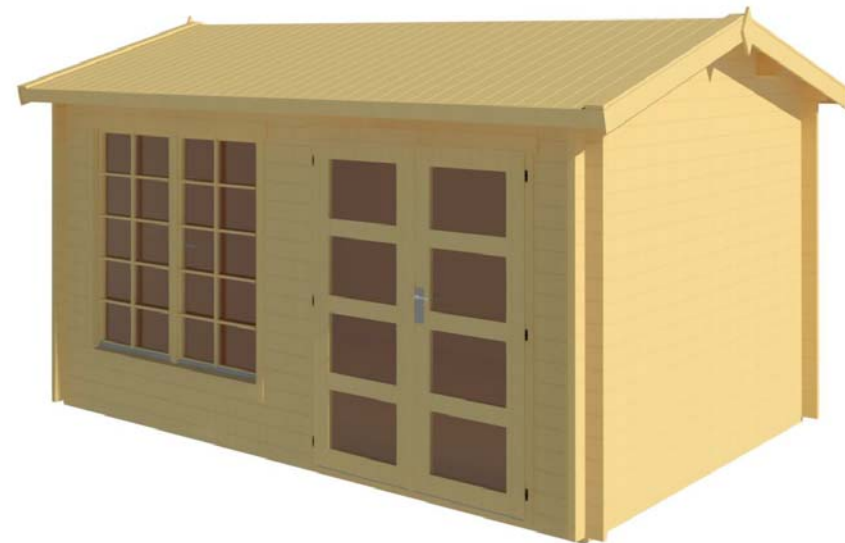

Irvine / Iris 40 (398x308)

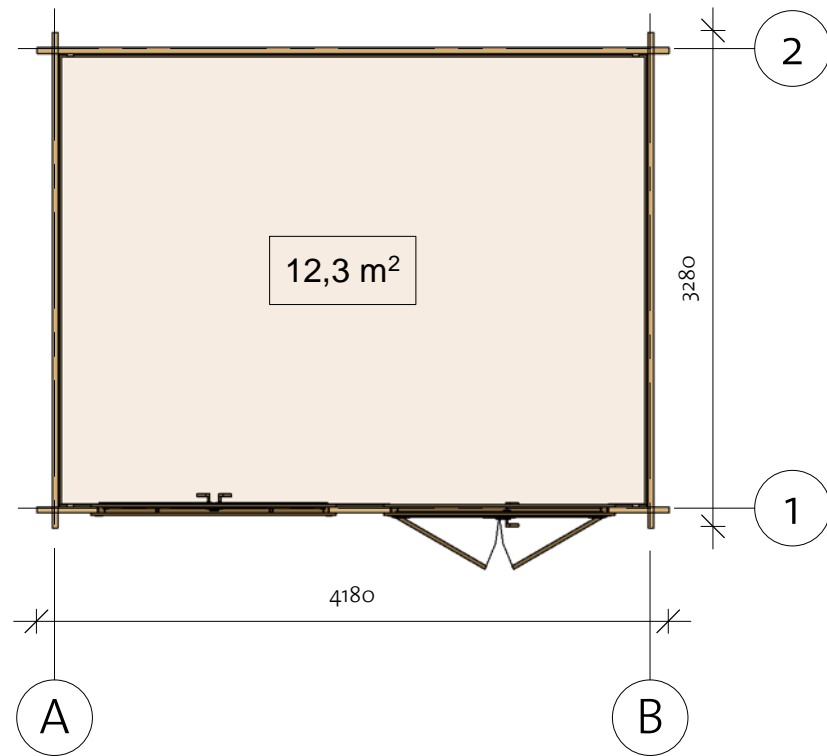
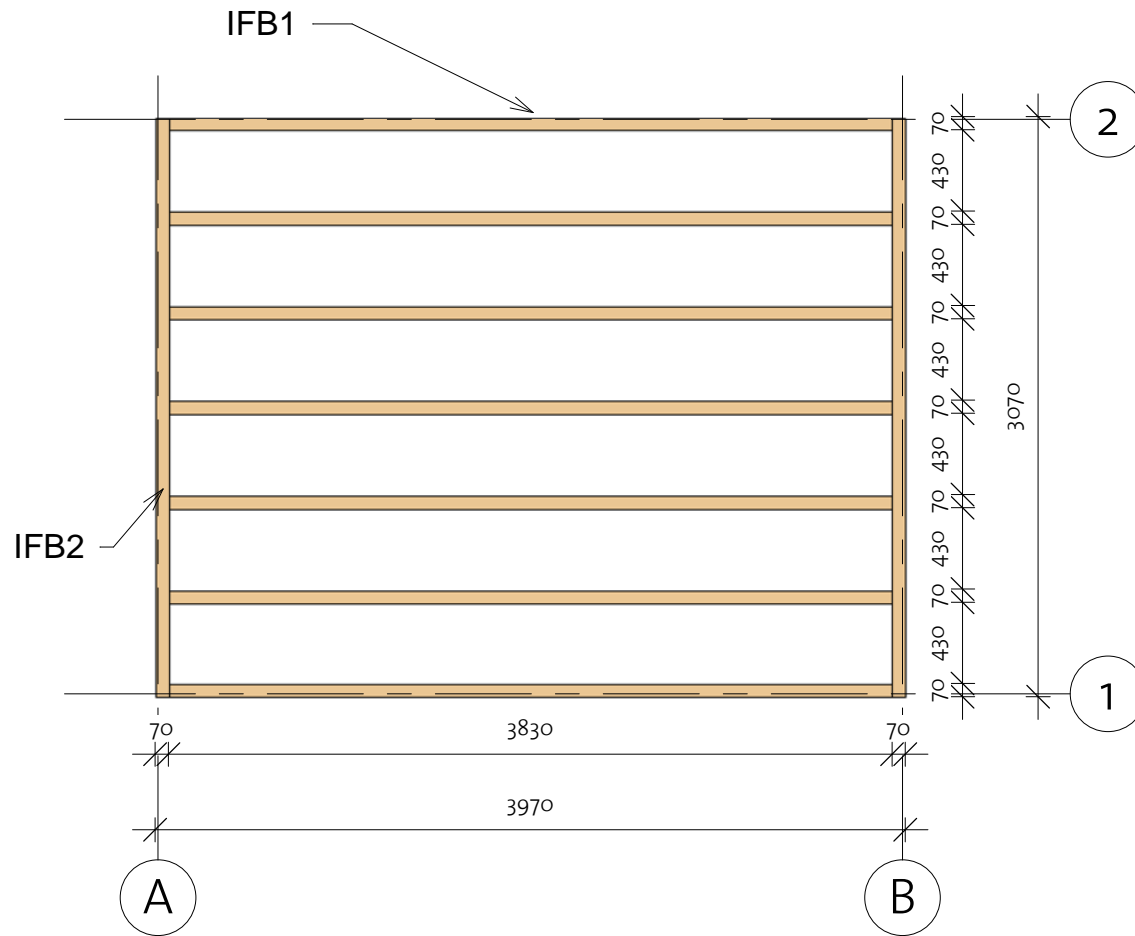

Iris 40 (398x308)

Foundation



Impregnated foundation beams				
Mark	Type	Profile	Count	Length
IFB1	IFB 70x40		7	3830
IFB2	IFB 70x40		2	3070



Iris 40 (398x308)

Floor Plan

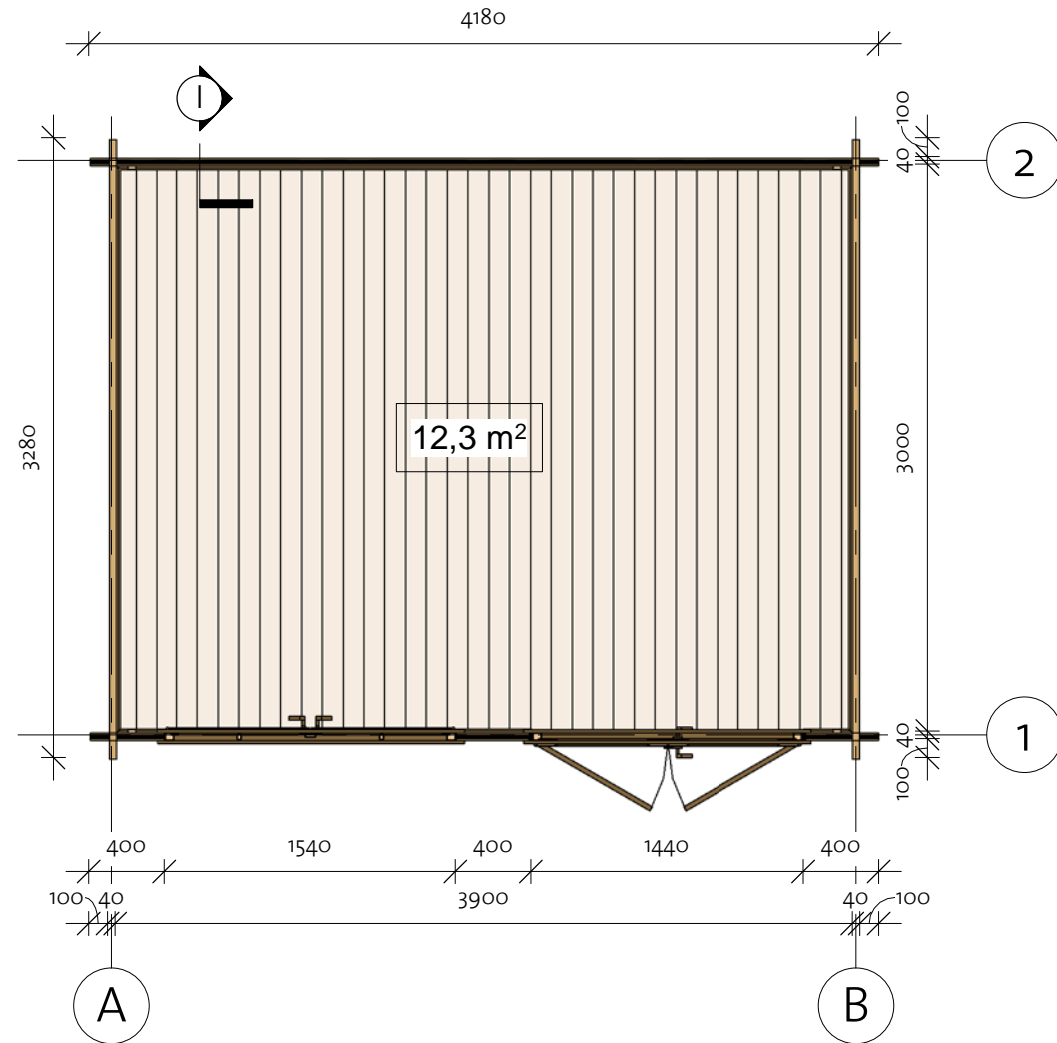
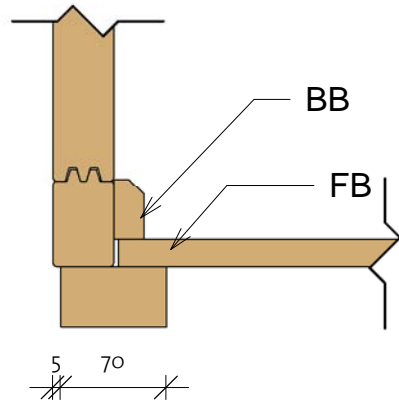
① Baseboard



Floor Schedule

Mark	Type	Profile	Count	Length
FB	FB 18x110		37	2997
BB1	BB 20x40		2	3980
BB2	BB 20x40		2	3080

91923051_190531

Iris 40 (398x308)

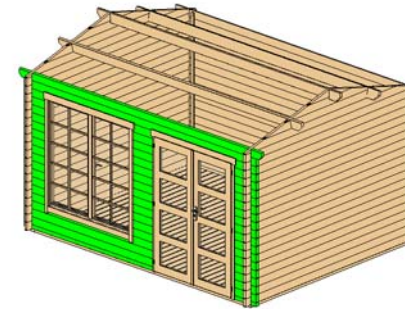

Wall 1



Wall 1			
Mark	Profile	Count	Cut Length

1BL-1	40X57	1	400
1BL-2	40X57	1	2340
1LG-1	40X114	31	400
1LG-2	40X114	14	400
1LG-3	40X114	3	2340
1LG-4	40X114	1	4180
1TL-1	40X114	1	4380

Log Profile Wall 1	
Profile	Profile

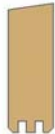
40X57	
40X114	
40X114	

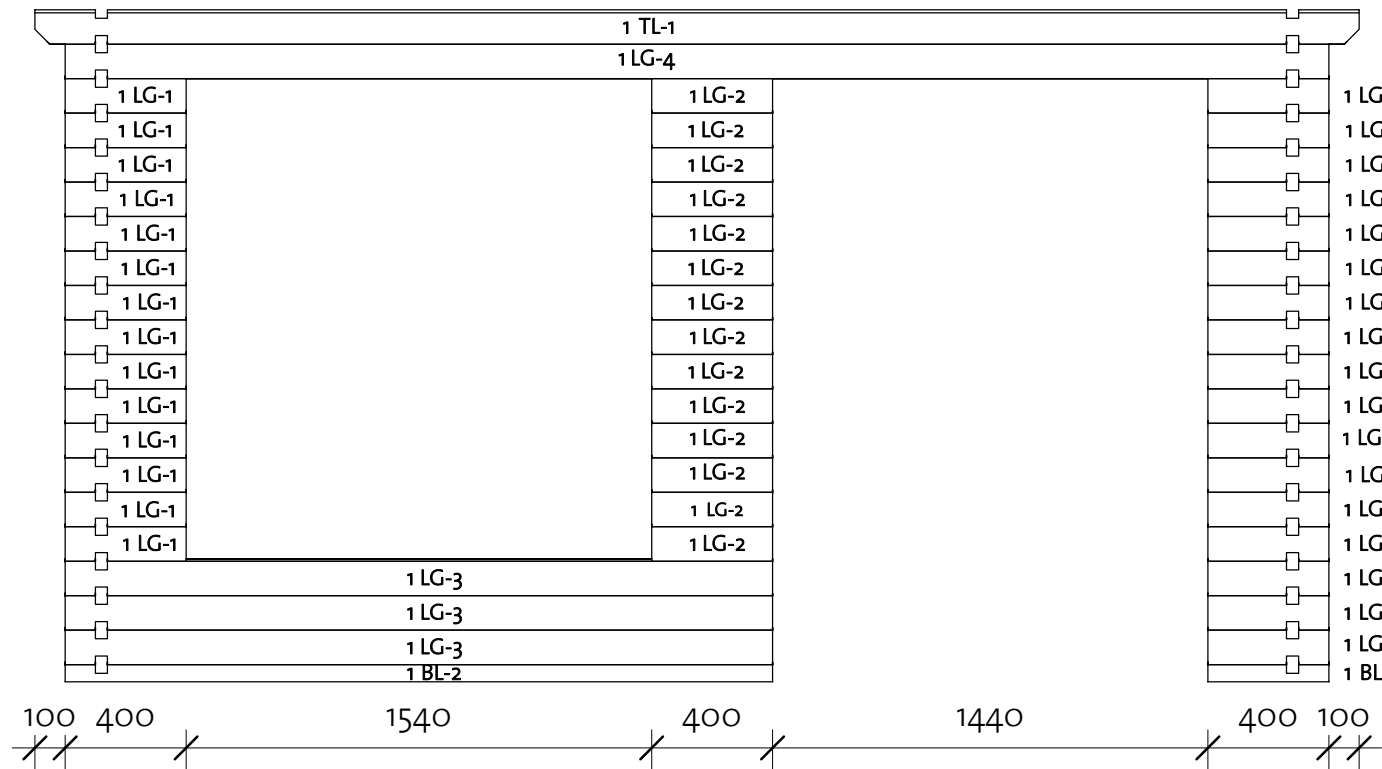

Iris 40 (398x308)

Wall 2

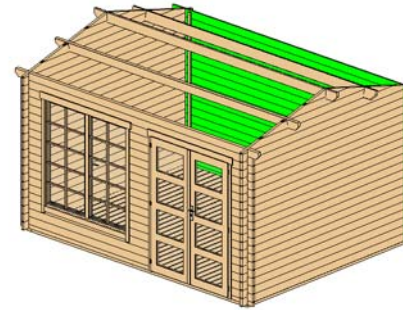

Wall 2			
Mark	Profile	Count	Cut Length

2BL-1	40x57	1	4180
2LG-1	40x114	18	4180
2TL-1	40x114	1	4380

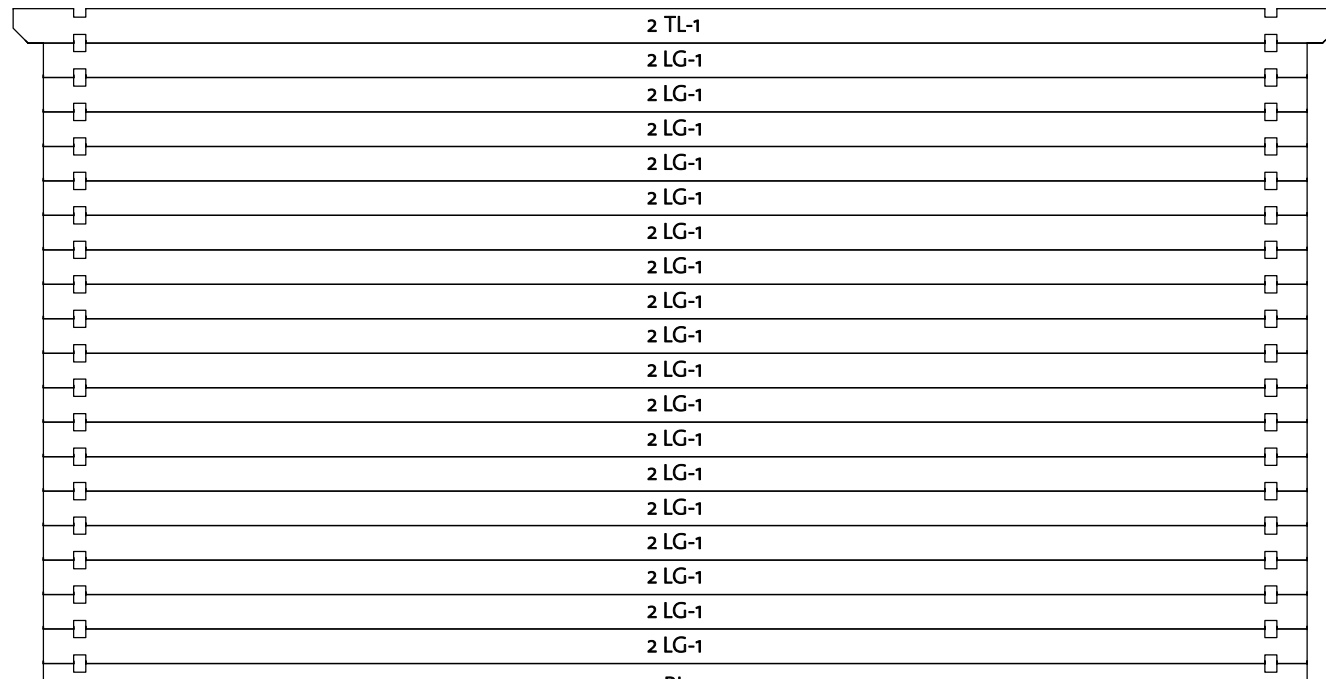

100
/ /

4180

100
/ /

Log Profile Wall 2	
Profile	Profile

40x57	
40x114	
40x114	

Iris 40 (398x308)

Wall A

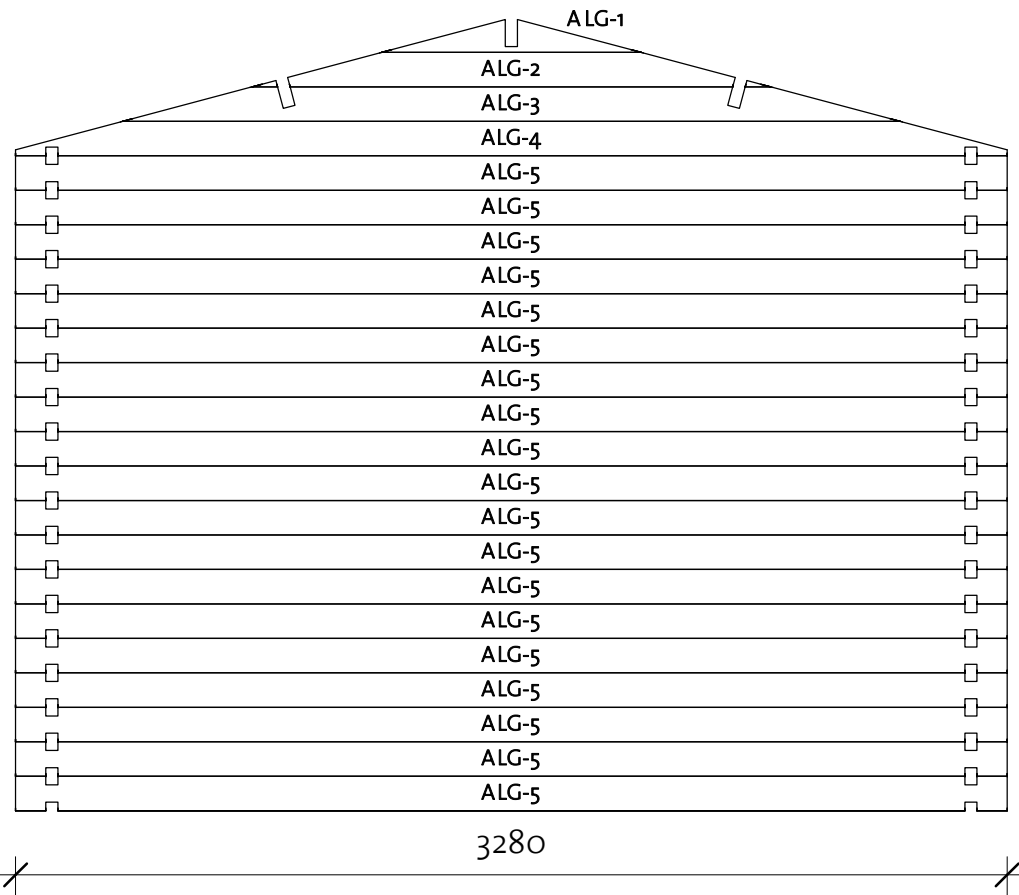
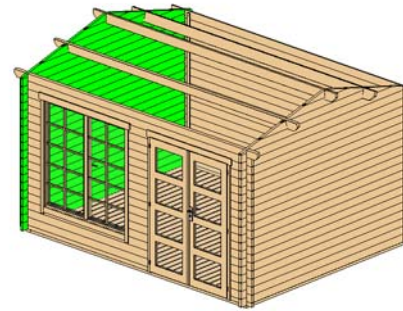

Wall A			
Mark	Profile	Count	Cut Length

ALG-1*	40x114	1	858
ALG-2*	40x114	1	1715
ALG-3*	40x114	1	2572
ALG-4*	40x114	1	3280
ALG-5	40x114	19	3280

*Gable-delivered premounted

Log Profile Wall A	
Profile	Profile

40x114	
--------	--

Iris 40 (398x308)

Wall B

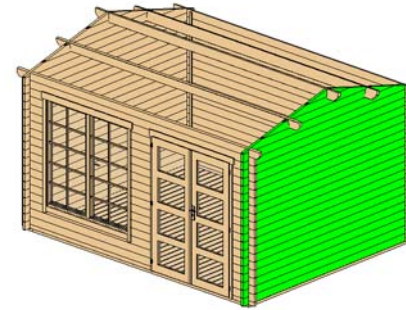

Wall B			
Mark	Profile	Count	Cut Length

BLG-1*	40x114	1	858
BLG-2*	40x114	1	1715
BLG-3*	40x114	1	2572
BLG-4*	40x114	1	3280
BLG-5	40x114	19	3280

*Gable-delivered premounted

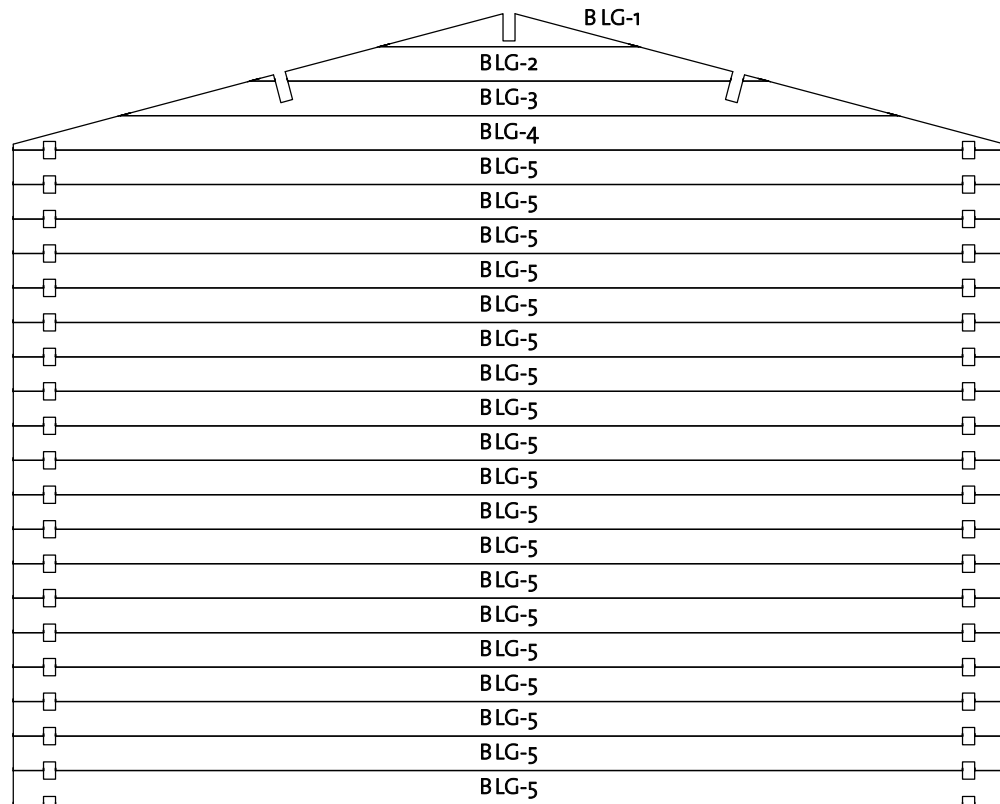





Log Profile Wall B	
Profile	Profile

40X114	
--------	--

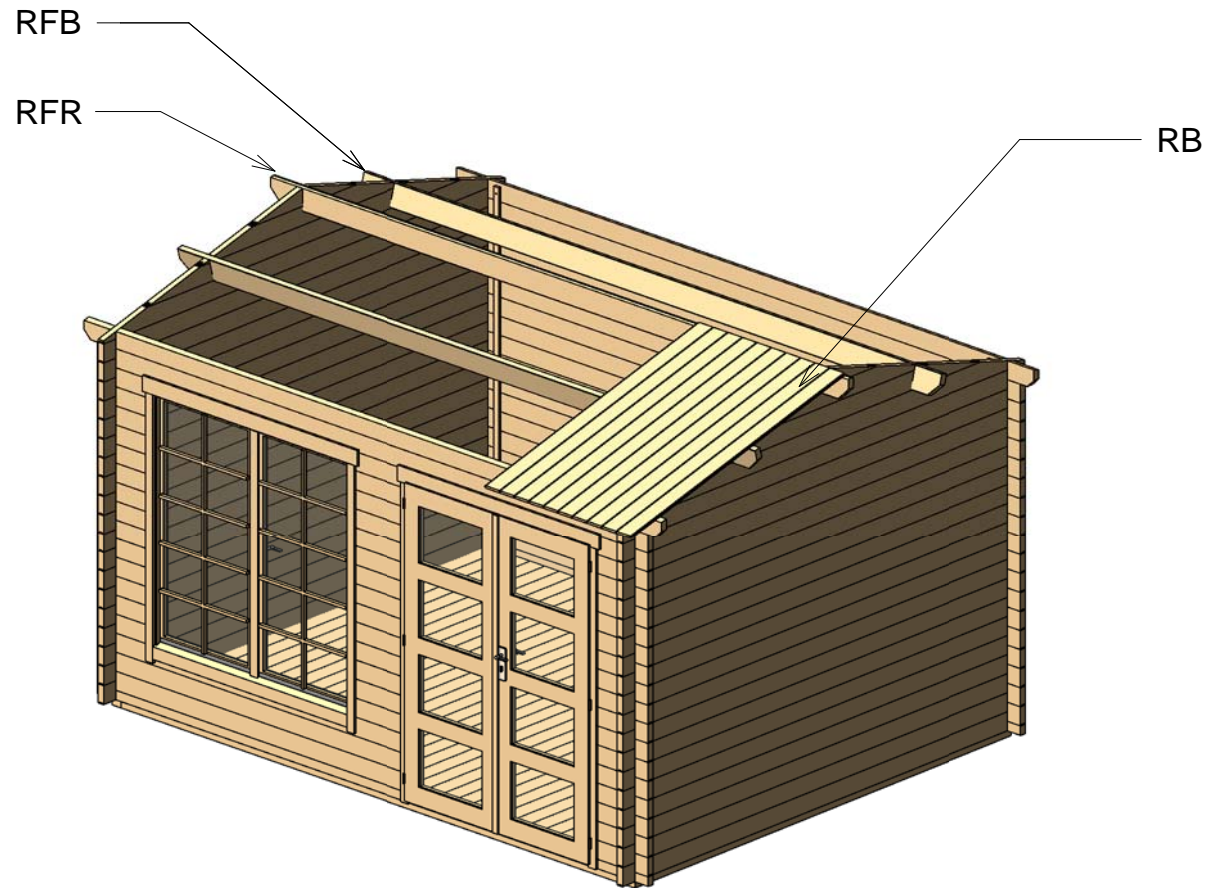
Iris 40 (398x308)

Roof 1



Roof				
Mark	Type	Profile	Count	Length
RFR	Ridge 40x143		1	4380
RFB	Beam 40x143		2	4380
RB	18x110		84	1796

Iris 40 (398x308)

Roof 2

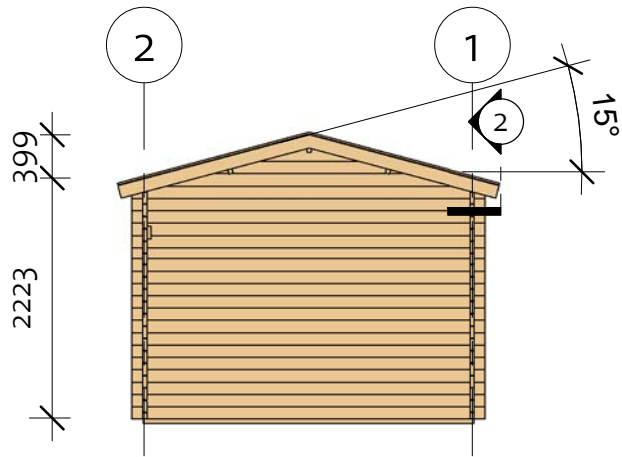

② Facia

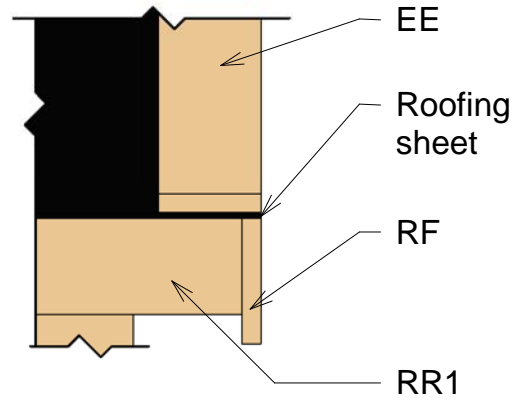

③ Roof Reinforcement

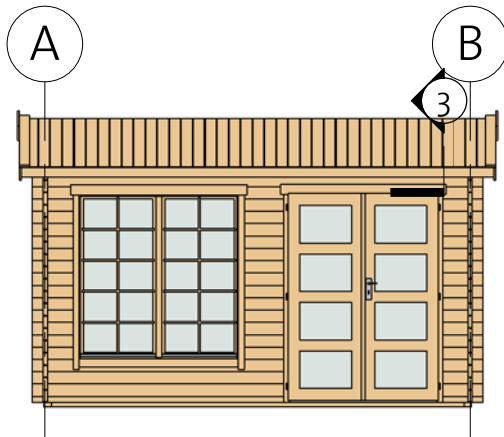
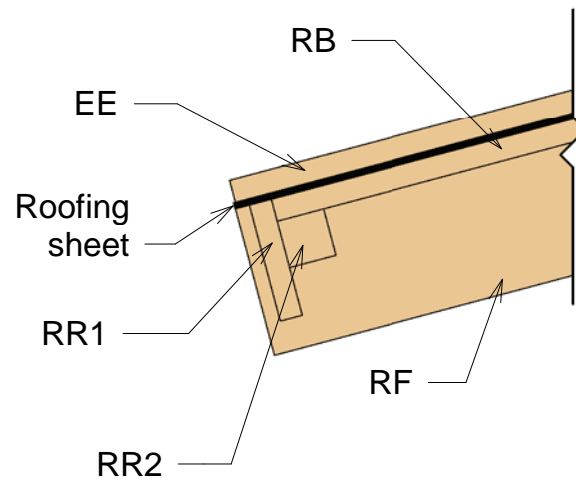

Fascia Schedule				
Mark	Type	Profile	Count	Length

EE	Eave Edging 18x95		4	1830
RF2	Roof Fascia 18x120		4	1830
RR1	Roof reinforcement 18x95		2	4380
RR2	Roof reinforcement 38x38		2	4380

Iris 40 (398x308)

Extras

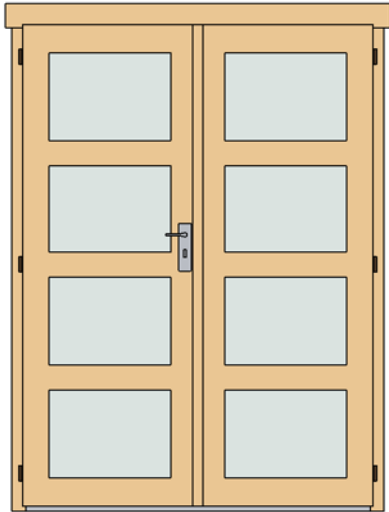

Door Schedule				
Mark	Type	Width	Height	Count

CDD2R	Classic double door 2, four glass right	1425	1955	1
-------	--	------	------	---

Window Schedule				
Mark	Type	width	height	Count

CDW4	Classic double window 4	1530	1555	1
------	-------------------------	------	------	---

WCB10	Windows Crossbar 10	--	--	2
-------	---------------------	----	----	---

Fasteners/Extras		
Name	Type	Count

Hitblock	300-400 mm	
Bolts	M8 x 70	12
Screws	5,0 x 70	15
Nails	1,4 x 40	35
Screws	6,0 x 140	45
Screws	4,0 x 40	90
Screws	4,0 x 50	550



Type	Count	Length
------	-------	--------

Windboard 18x40	4	2200
-----------------	---	------

Family	Count
--------	-------

Romb	2
------	---

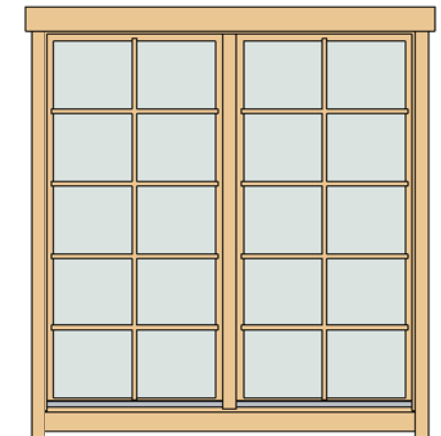



91923051_190531



Iris 40 (398x308)

List of all items 1



Impregnated foundation beams

Mark	Type	Profile	Count	Length
IFB1	IFB 70x40		7	3830
IFB2	IFB 70x40		2	3070





Floor Schedule

Mark	Type	Profile	Count	Length
FB	FB 18x110		37	2997
BB1	BB 20x40		2	3980
BB2	BB 20x40		2	3080

Roof

Mark	Type	Profile	Count	Length
RFR	Ridge 40x143		1	4380
RFB	Beam 40x143		2	4380
RB	18x110		84	1796

Fascia Schedule

Mark	Type	Profile	Count	Length
EE	Eave Edging 18x95		4	1830
RF2	Roof Fascia 18x120		4	1830
RR1	Roof reinforcement 18x95		2	4380
RR2	Roof reinforcement 38x38		2	4380

Iris 40 (398x308)

List of all items 2

Wall 1			
Mark	Profile	Count	Cut Length

1BL-1	40X57	1	400
1BL-2	40X57	1	2340
1LG-1	40X114	31	400
1LG-2	40X114	14	400
1LG-3	40X114	3	2340
1LG-4	40X114	1	4180
1TL-1	40X114	1	4380

Wall 2			
Mark	Profile	Count	Cut Length

2BL-1	40X57	1	4180
2LG-1	40X114	18	4180
2TL-1	40X114	1	4380

Wall A			
Mark	Profile	Count	Cut Length



ALG-1*	40X114	1	858
ALG-2*	40X114	1	1715
ALG-3*	40X114	1	2572
ALG-4*	40X114	1	3280
ALG-5	40X114	19	3280

Wall B			
Mark	Profile	Count	Cut Length

BLG-1*	40X114	1	858
BLG-2*	40X114	1	1715
BLG-3*	40X114	1	2572
BLG-4*	40X114	1	3280
BLG-5	40X114	19	3280

*Gable-delivered premounted

Log Profiles	
Profile	Profile

40X57	
40X114	

Log Profiles	
Profile	Profile

40X114	
--------	---