

PREPARE THE GROUND, UNWRAP THE PACKAGE,  
LAY OUT THE COMPONENTS, FIND THE TOOLS.

# LUND 40

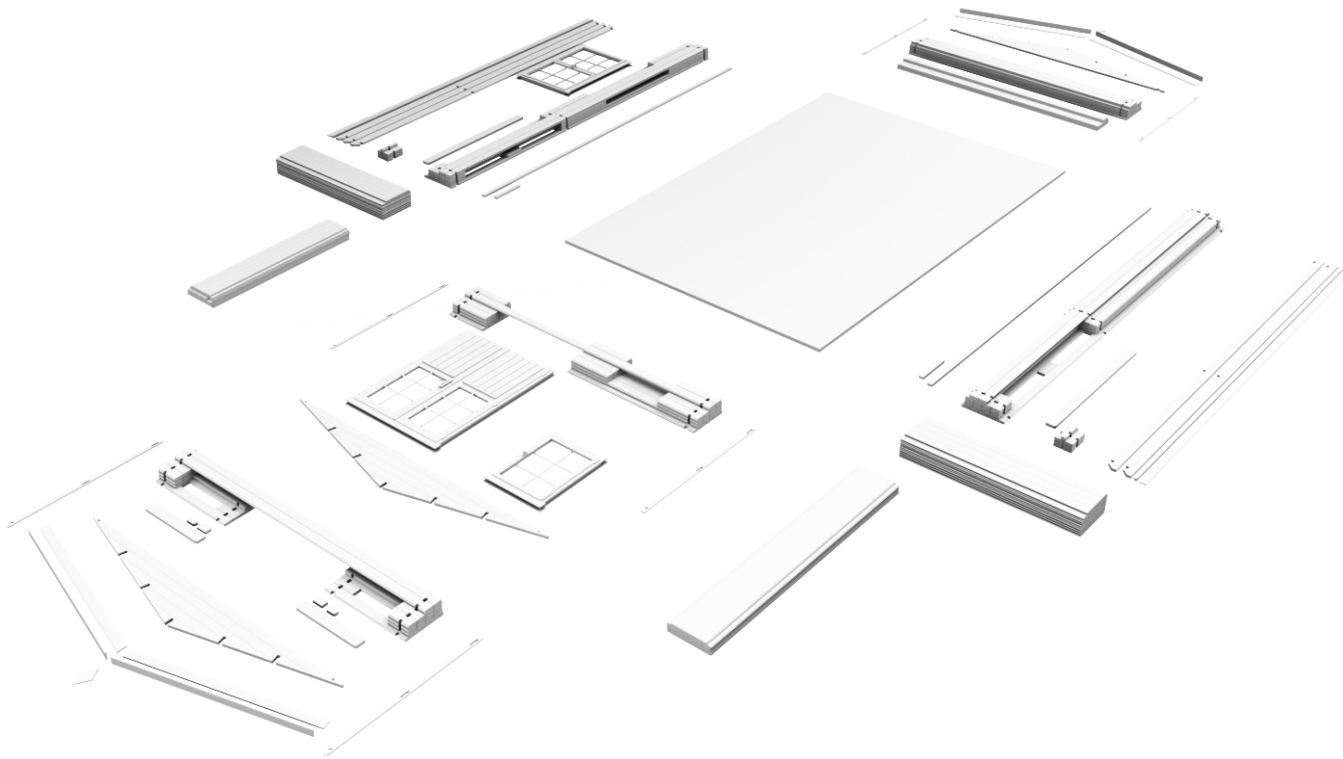
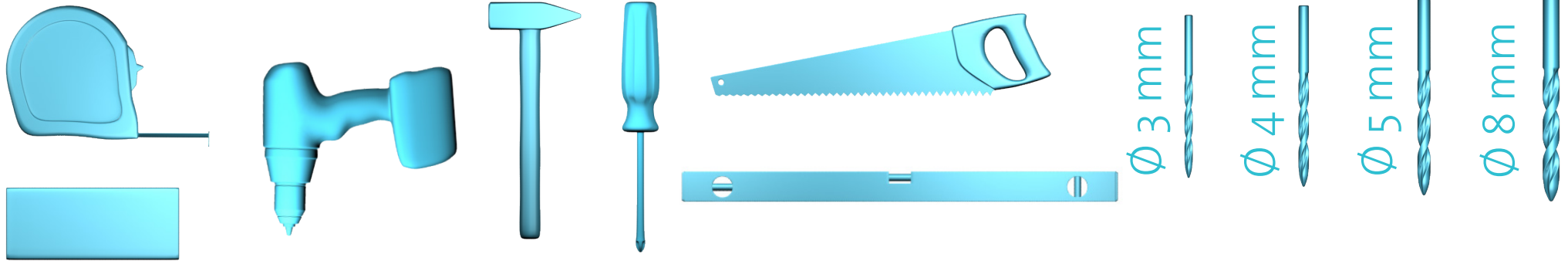

4x40 × 120

4x50 × 950

5x70 × 15

6x140 × 120

M8x70 × 18

LAY OUT THE FOUNDATION BEAMS AND SQUARE IT BY MEASURING FROM CORNER TO CORNER.

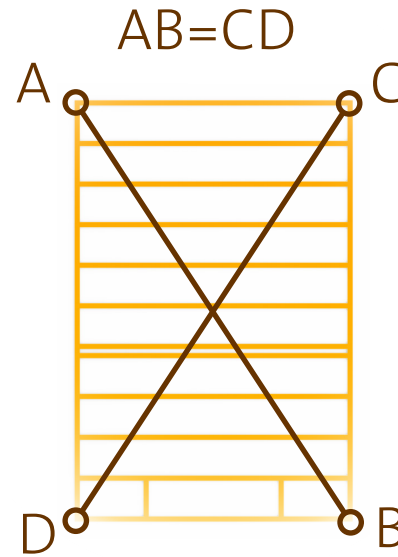

LUND 40

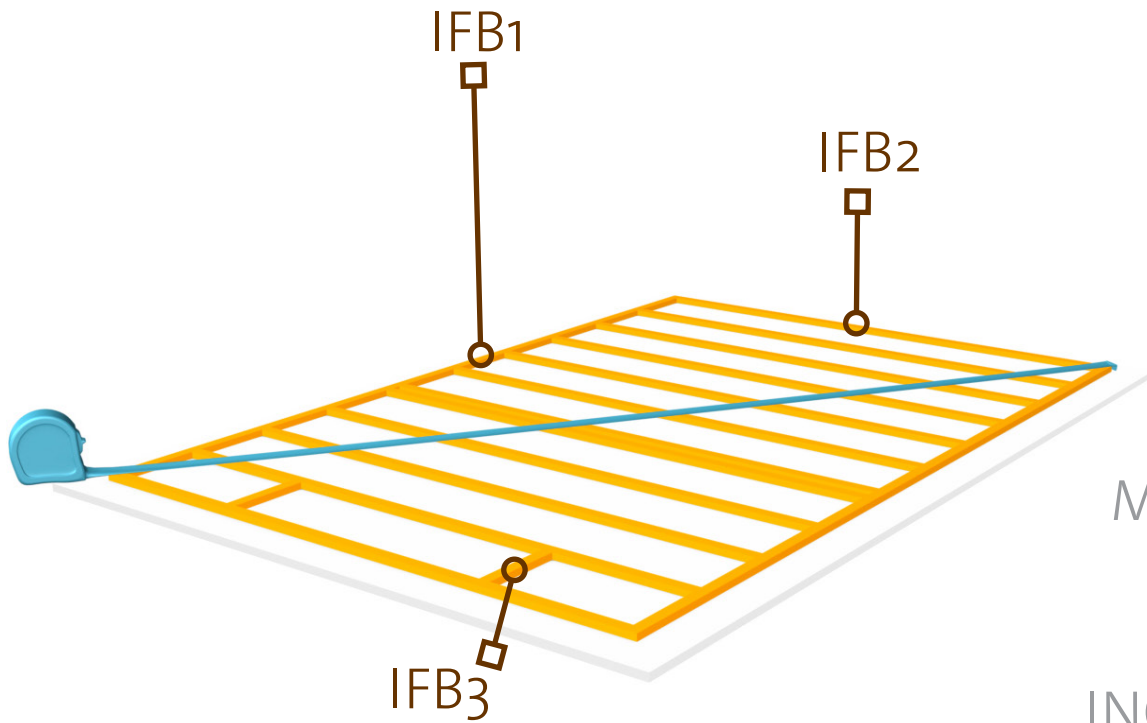

MAKE SURE THAT THE FOUNDATION IS INSTALLED ON A LEVEL SURFACE. CHECKING ALL DIRECTIONS, INCLUDING CORNER TO CORNER. 2%

ATTACH FOUNDATION BEAMS  
WITH SCREWS.

LUND 40

6x140  × 28

Ø 5 mm 

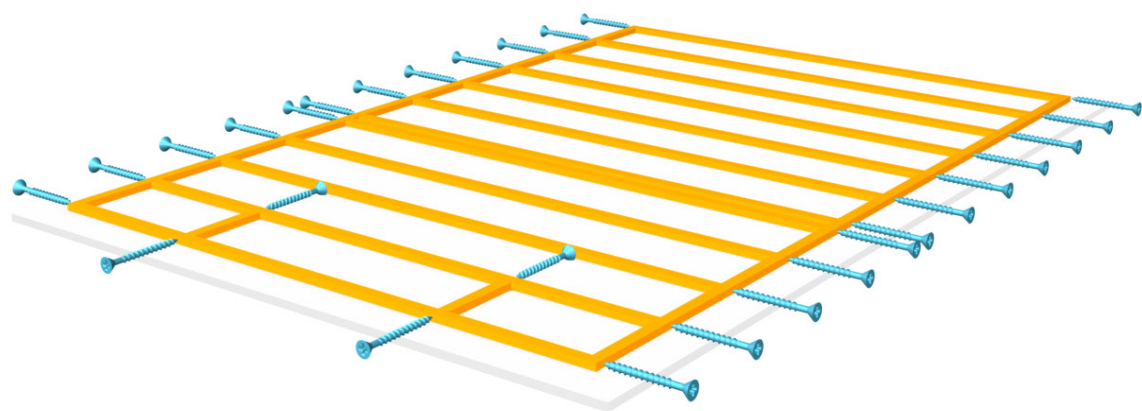
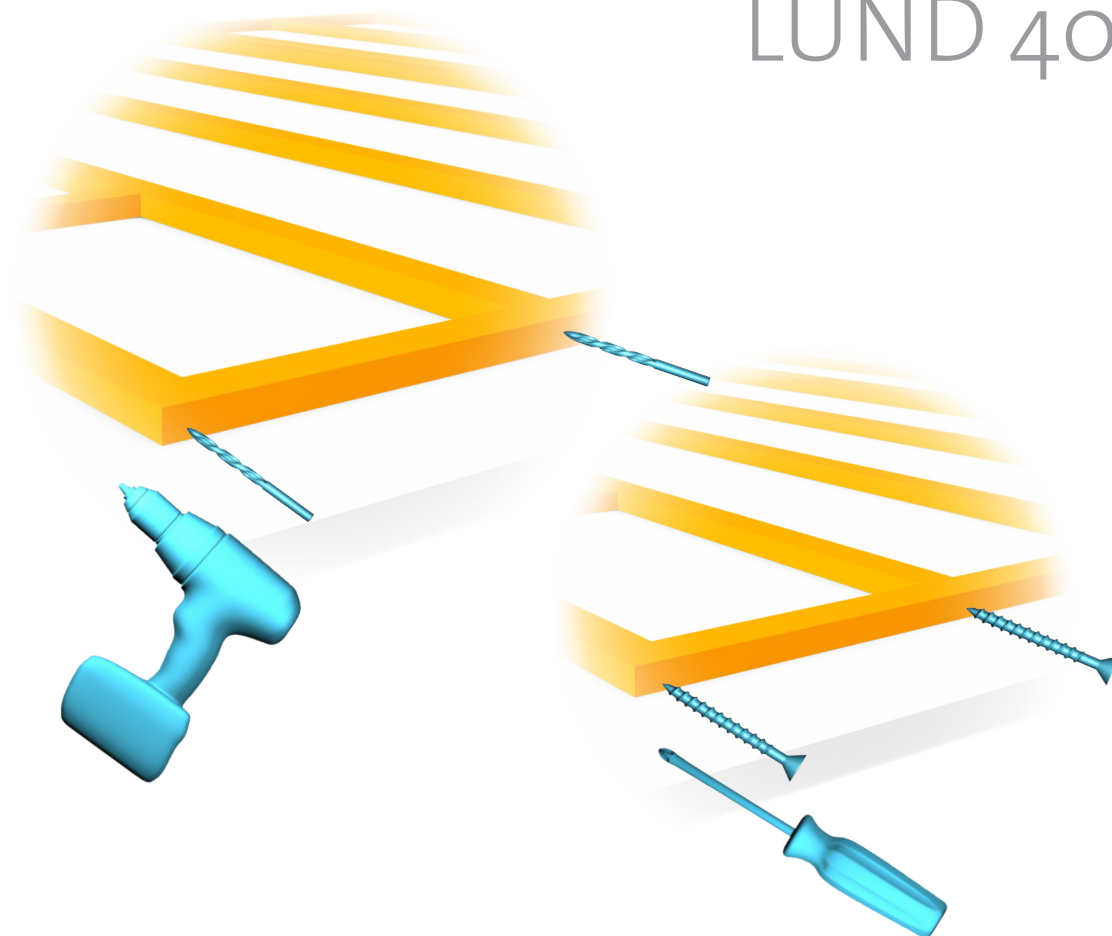

LAY OUT THE **BOTTOM** LOGS,  
**ATTACH** TO THE FOUNDATION.

LUND 40

$5 \times 70$   $\times$  6  
 $6 \times 140$   $\times$  14  
 $\varnothing 4$  mm  
 $\varnothing 5$  mm

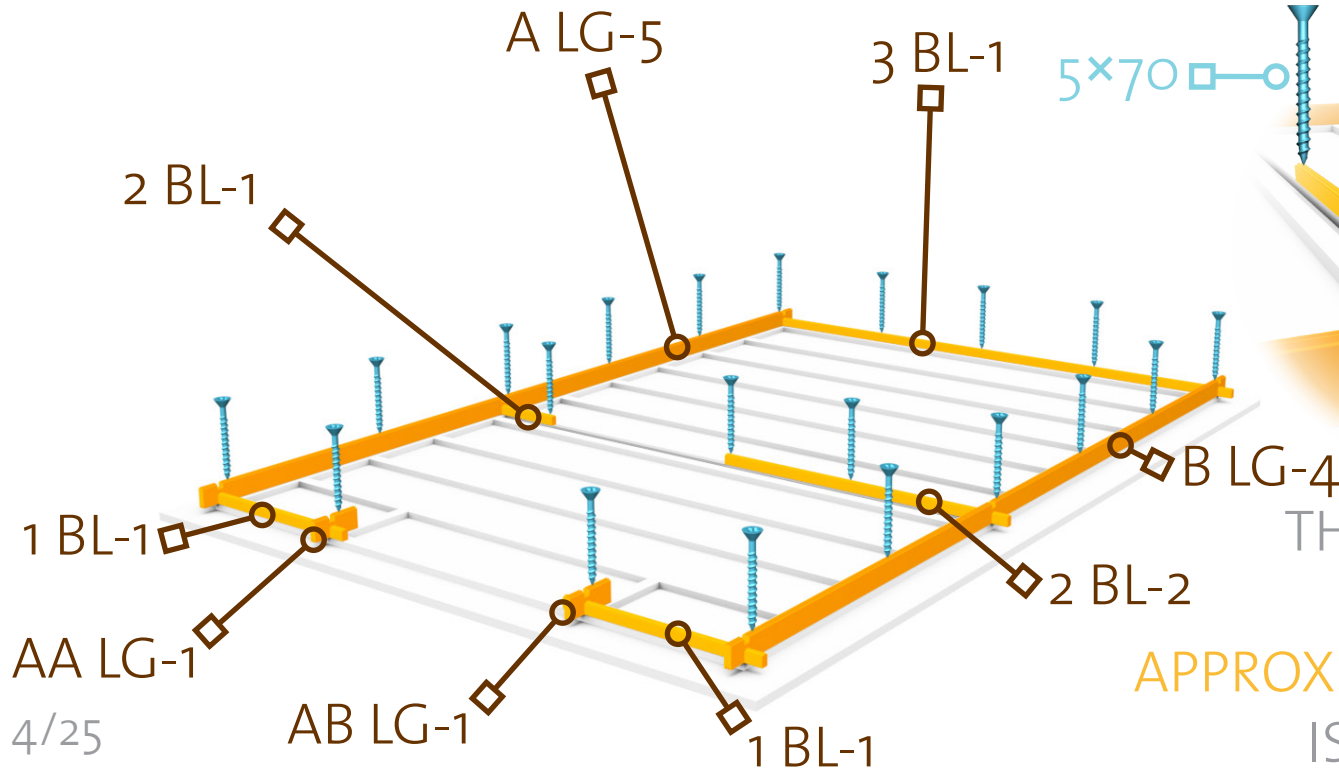
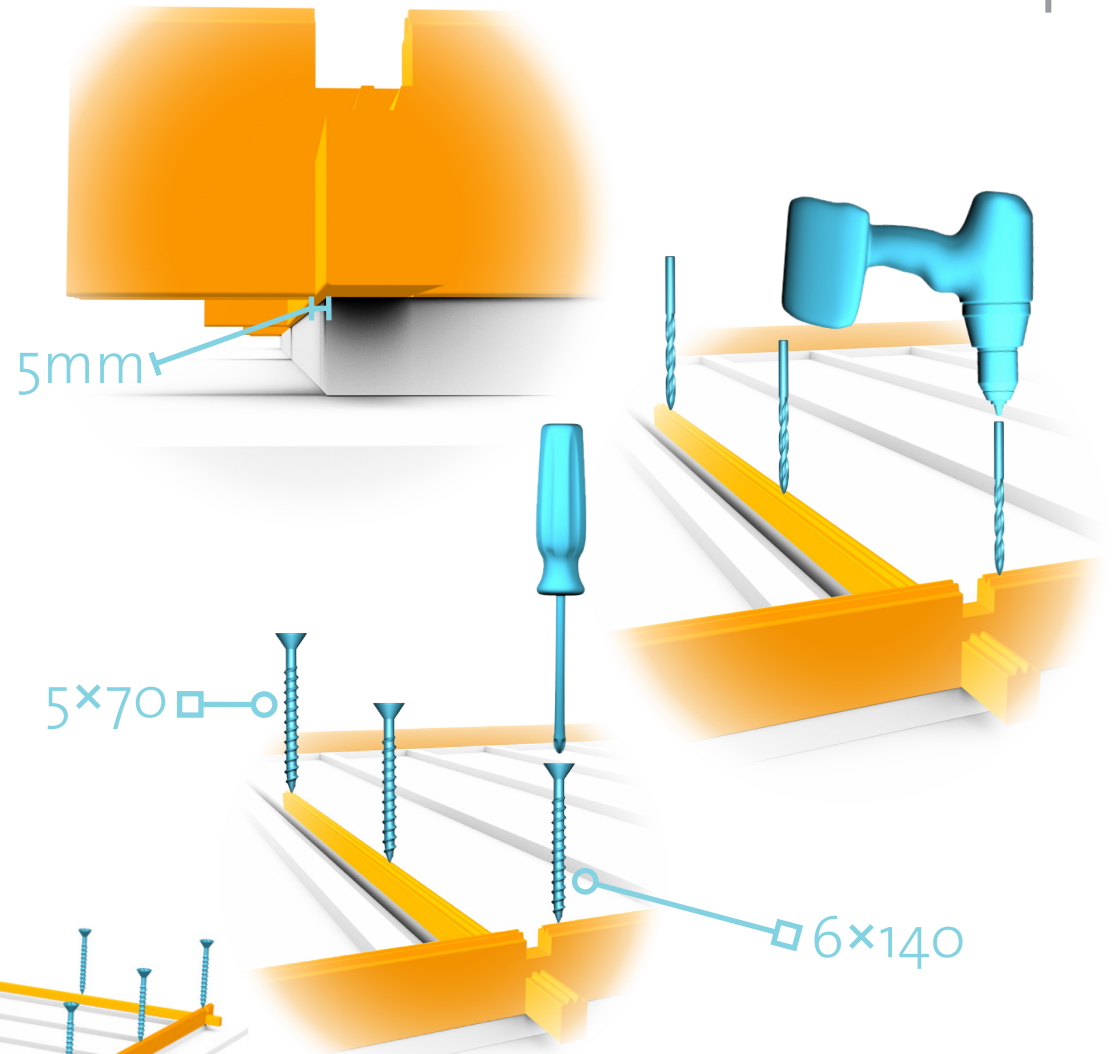

THE WALL **LOGS** WILL HANG OVER  
THE FOUNDATION **BEAMS** BY  
**APPROXIMATELY** 5MM. THIS OVERHANG  
IS DESIGNED AS A RAIN DRIP. **5%**

ATTACH THE FIRST ROW OF WALL LOGS INTO THE BOTTOM LOGS WITH SCREWS.

$5 \times 70$   $\times$  8  $6 \times 140$   $\times$  6  
 $\varnothing 4$  mm  $\varnothing 5$  mm

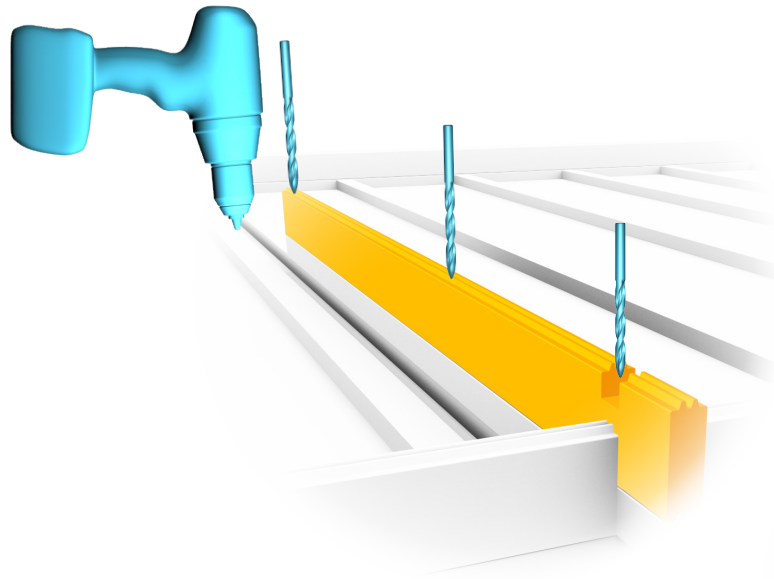

LUND 40

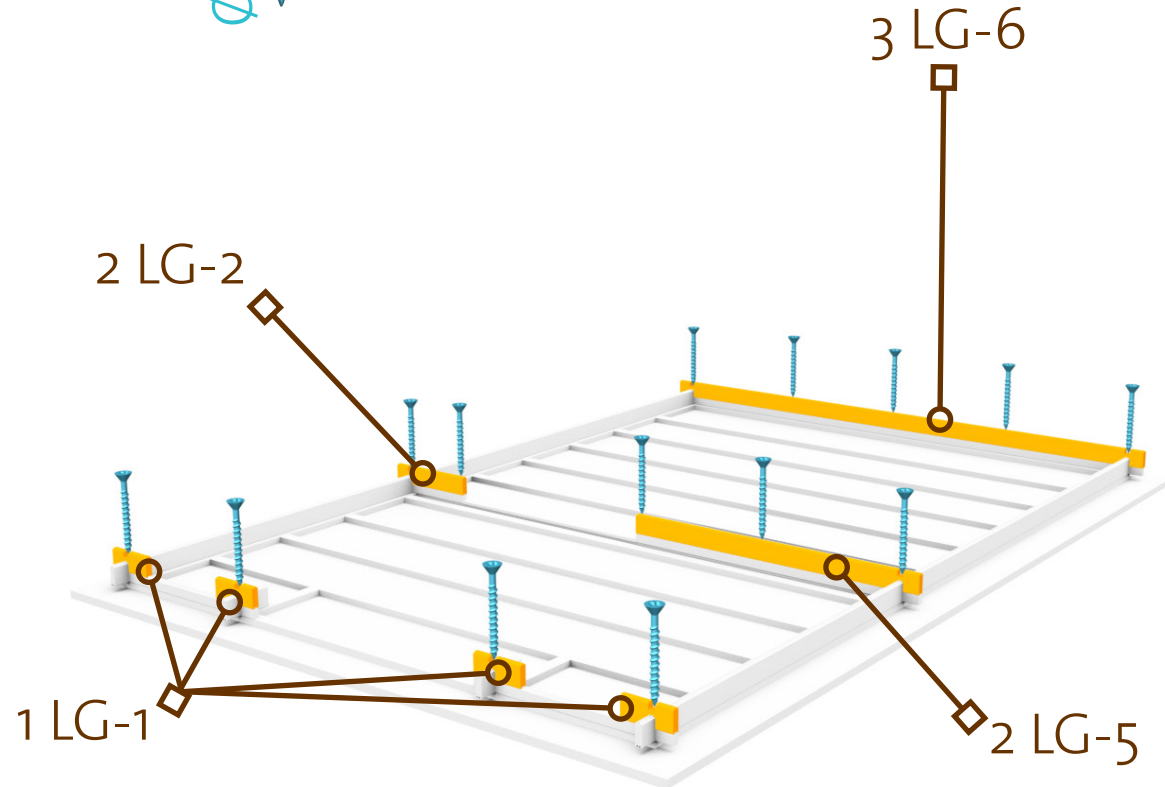
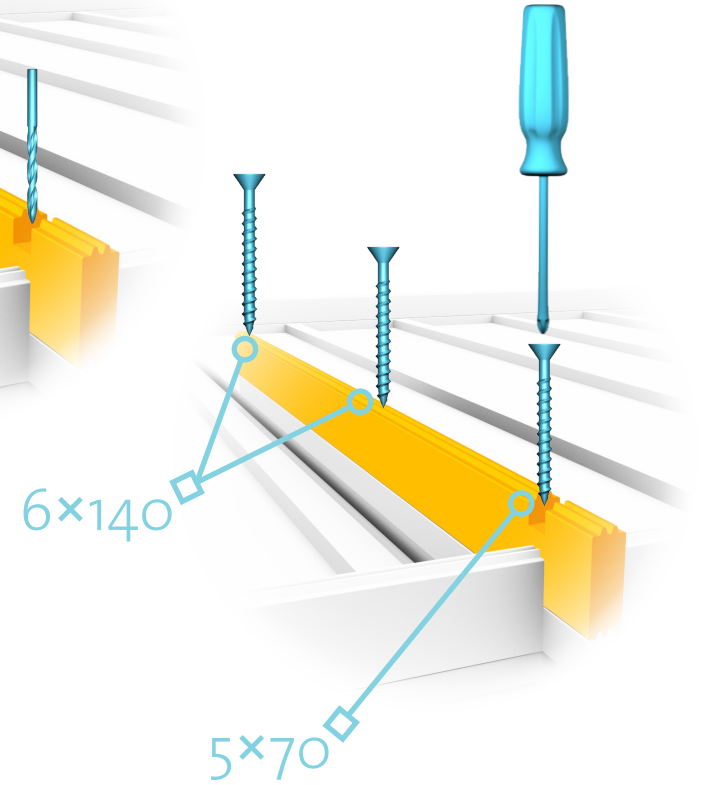

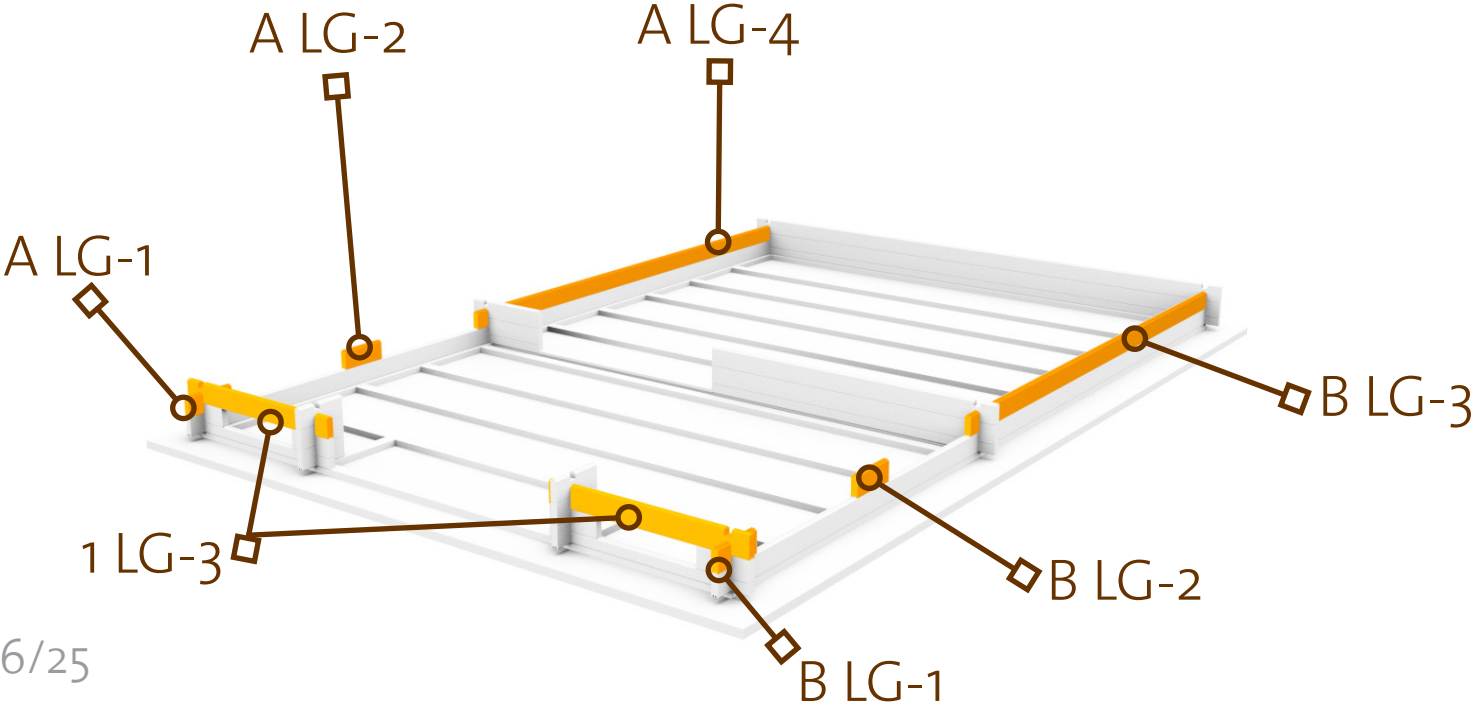

AFTER PLACING 3-4 ROWS OF WALL LOGS, TAP EACH WALL LOG IN PLACE USING A HAMMER AND THE HITBLOCK PROVIDED, TO TIGHTEN THE LOGS.

LUND 40

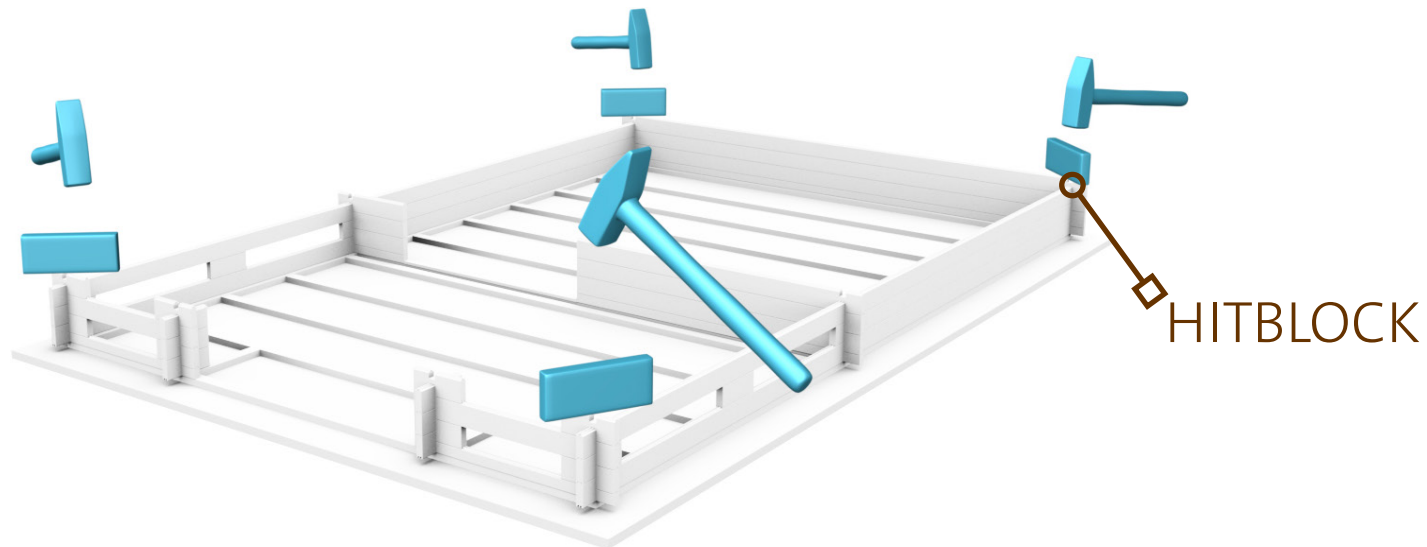

INSTALL THE DOOR BEAM UNDER THE DOOR. SLIDE THE DOOR IN, ATTACH THE HANDLE.

4x40  
× 3

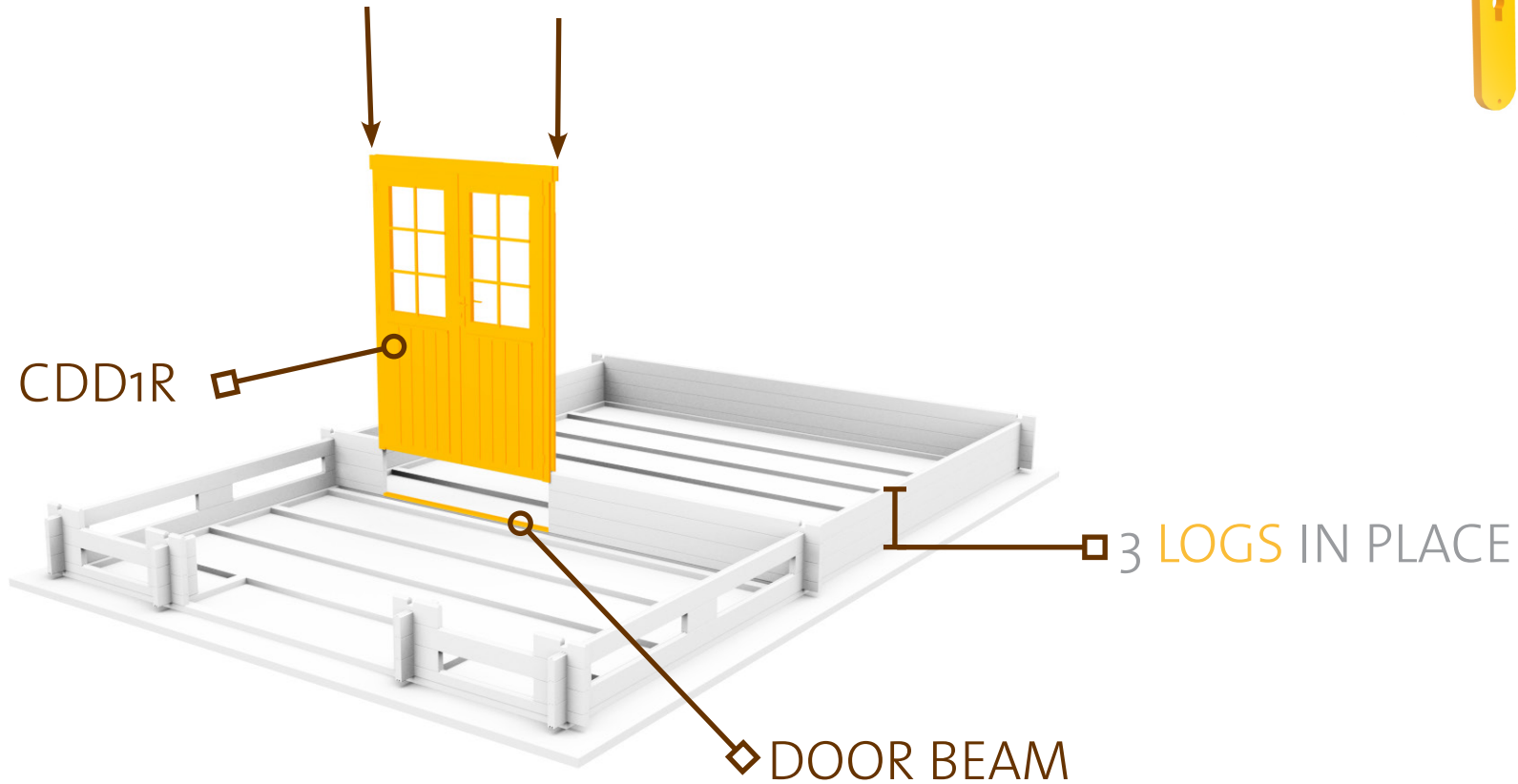
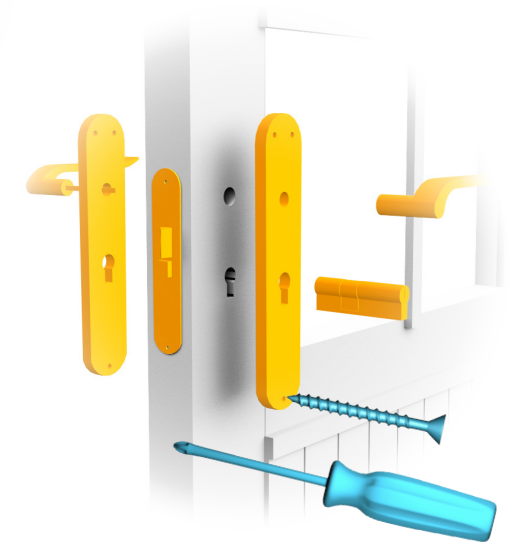
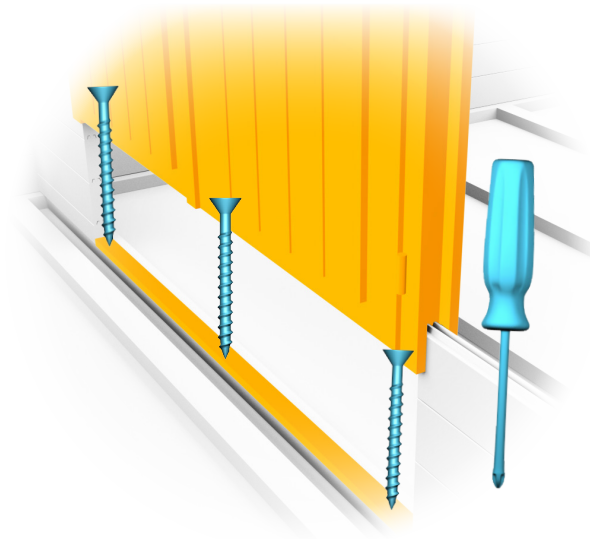



DON'T FORGET TO  
**TIGHTEN** THE LOGS AFTER  
EVERY 3-4 ROWS.

LUND 40

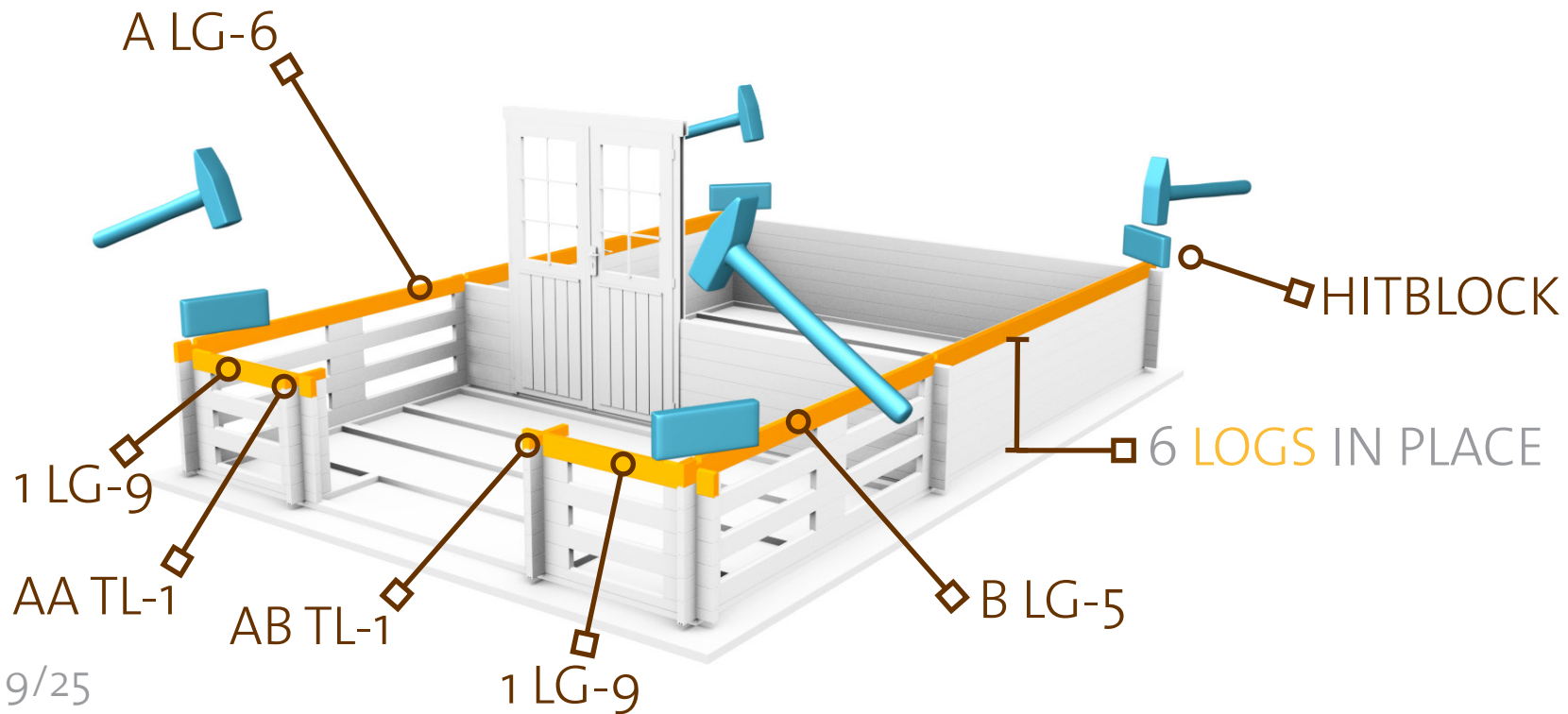

ATTACH THE **HANDRAILS**  
WITH SCREWS.

6x140 × 28

Ø 5 mm

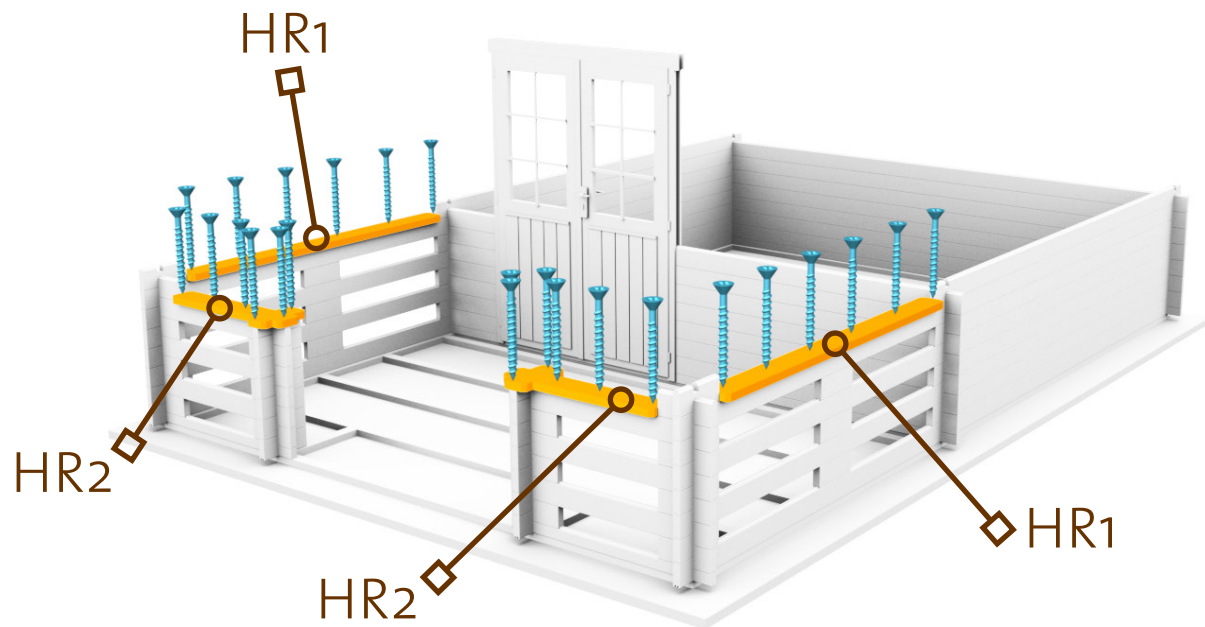
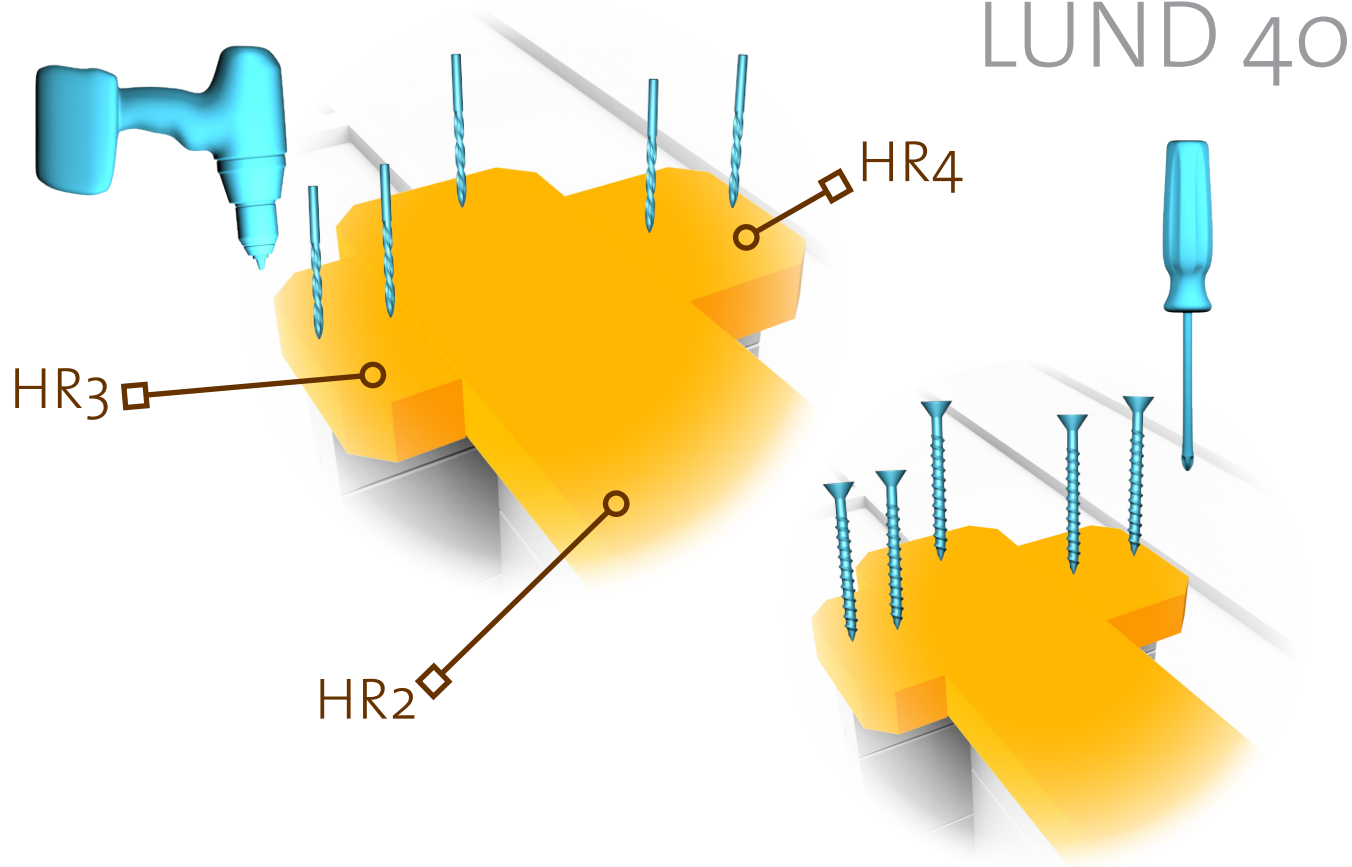

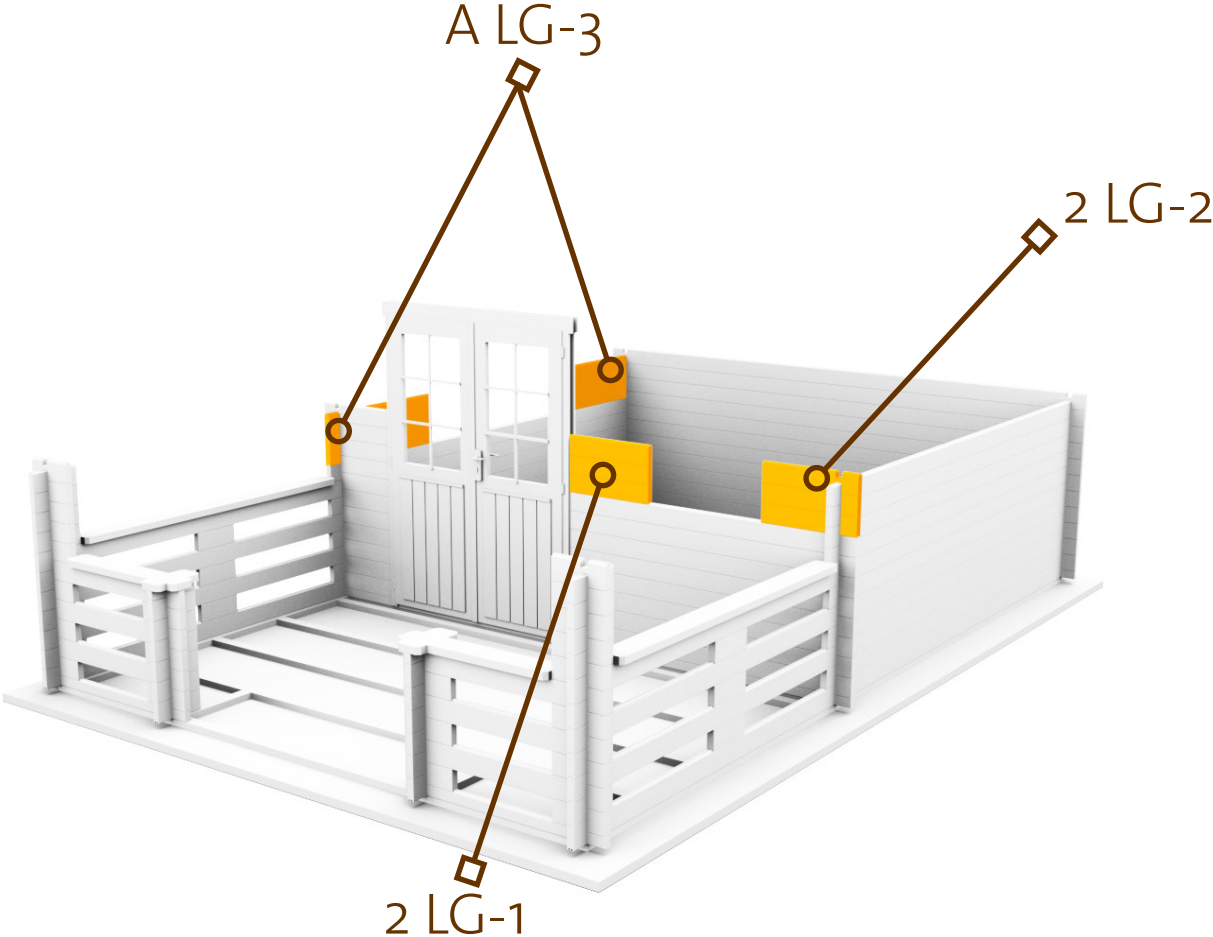

SLIDE THE **WINDOWS** IN,  
ATTACH THE **HANDLES**.

LUND 40

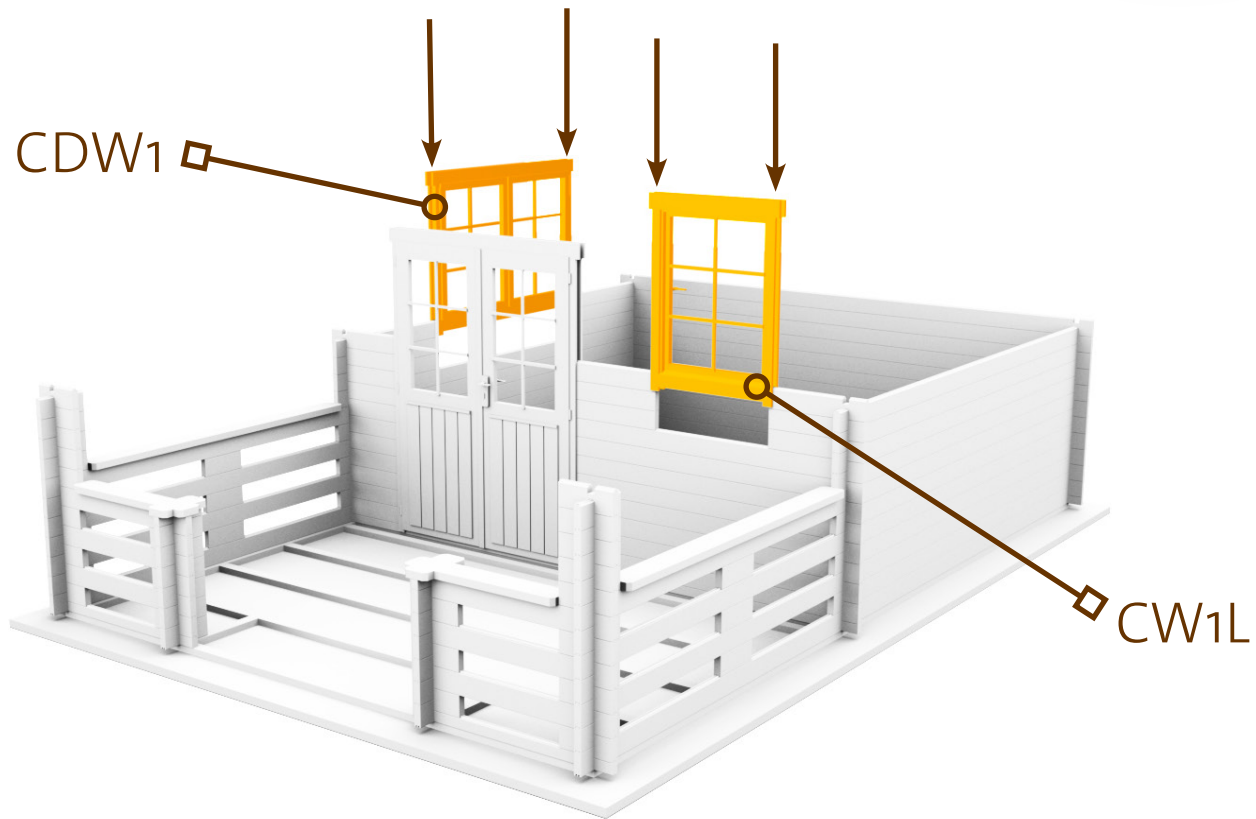
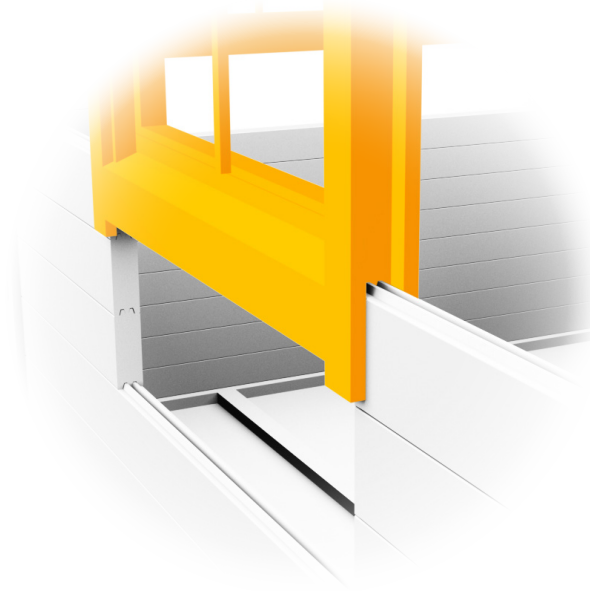

INSTALL THE GABLES WITH LONG SCREWS TO THE WALL LOGS ON THE FRONT AND REAR WALLS.

6x140 × 6

Ø 5 mm

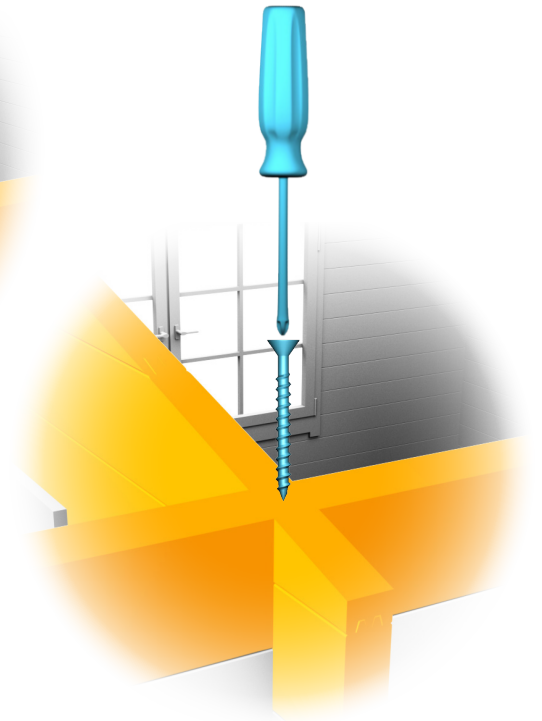
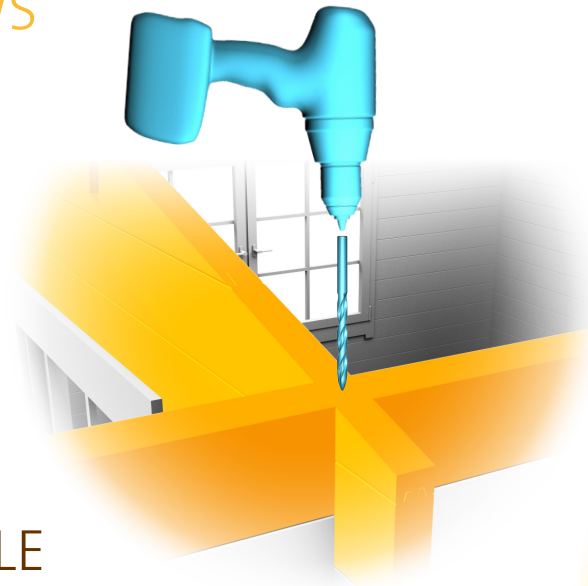
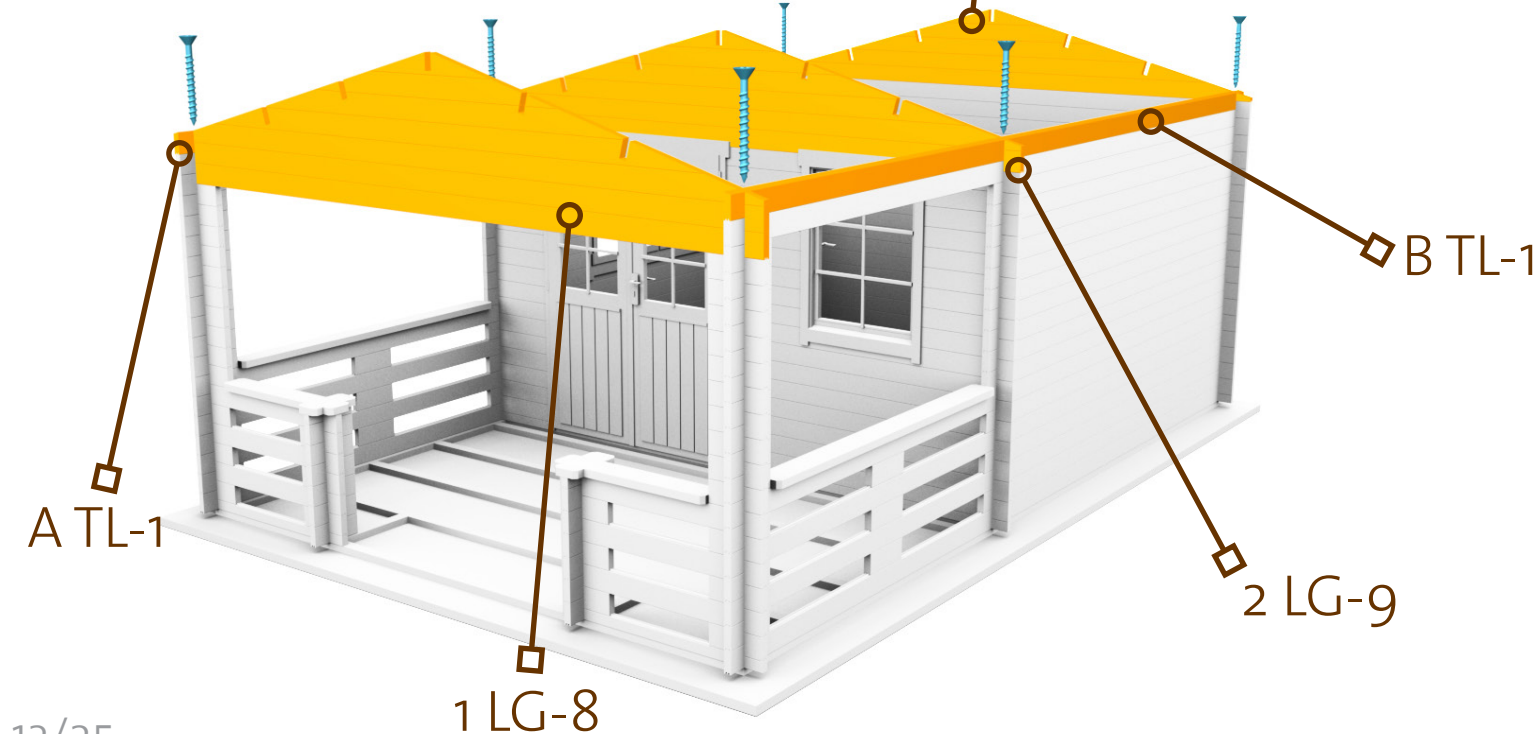

LUND 40

INSTALL THE **ROOF** PURLINS AND **ATTACH** THEM WITH SCREWS.

6x140 × 15

Ø 5 mm

RFR

RFB

LUND 40

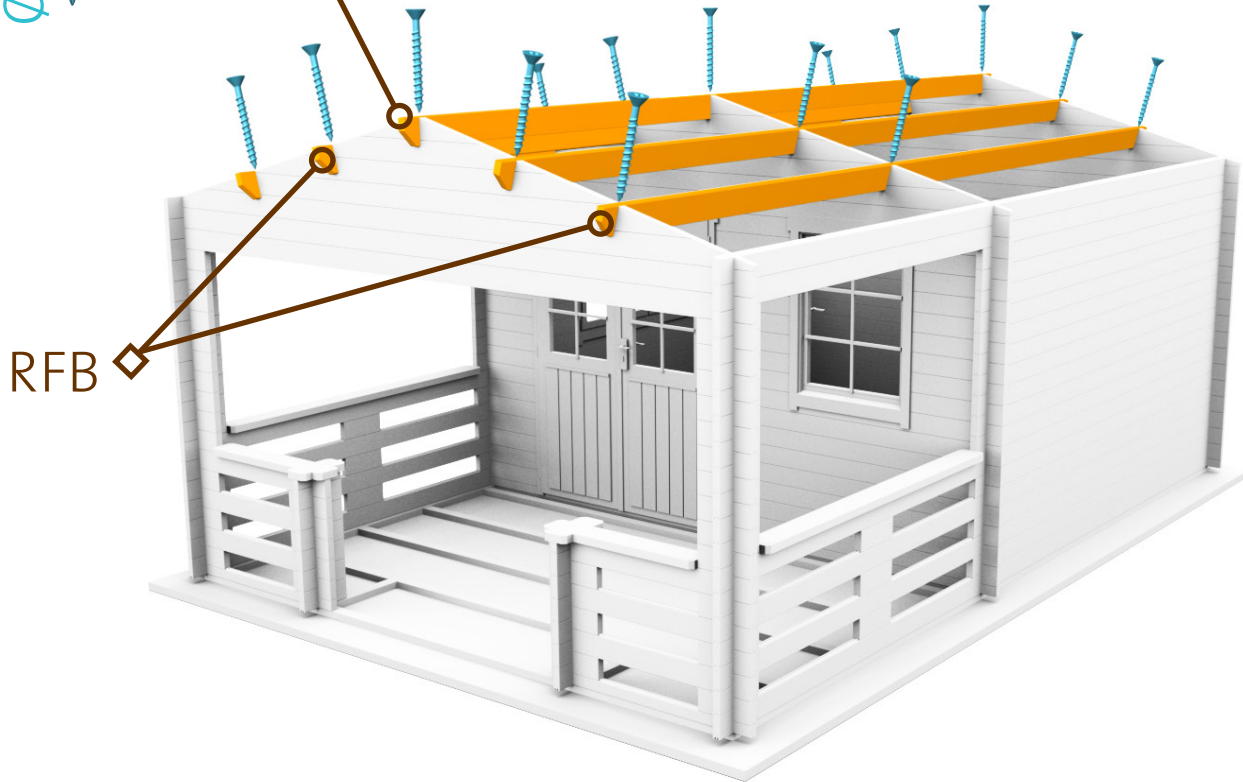
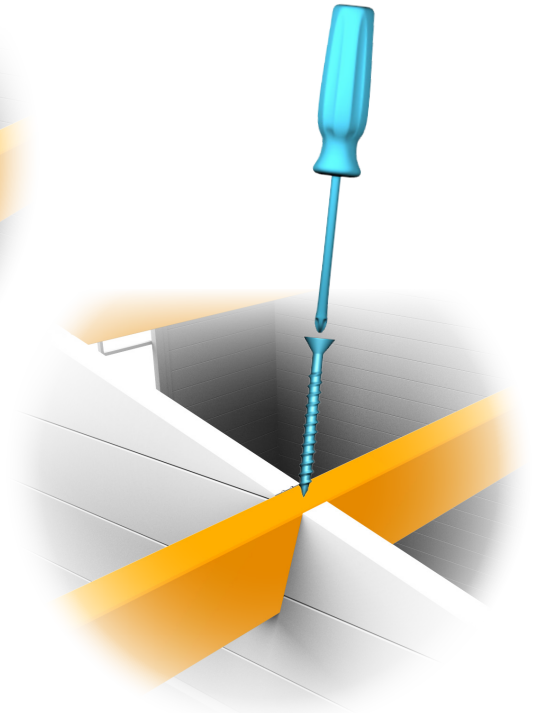
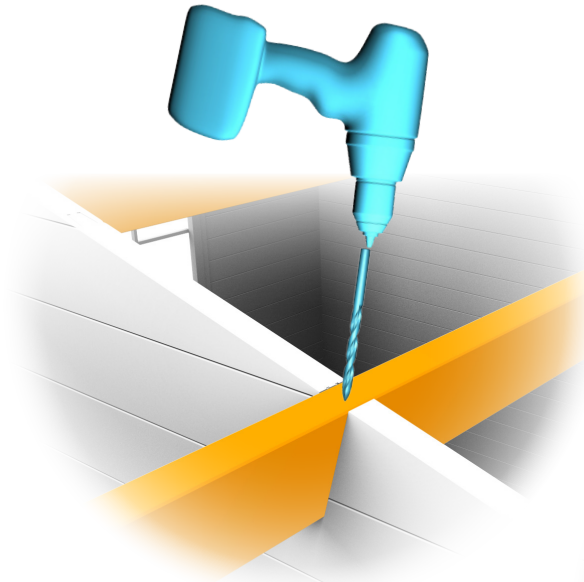

PLACE THE FIRST **ROOFBOARD** FLUSH WITH THE END OF THE **PURLINS** AND ATTACH WITH 8 SCREWS, 4 INTO **EACH** NEXT, SAW THE LAST **BOARD** TO MAKE IT FIT.

LUND 40

4x50  × 448

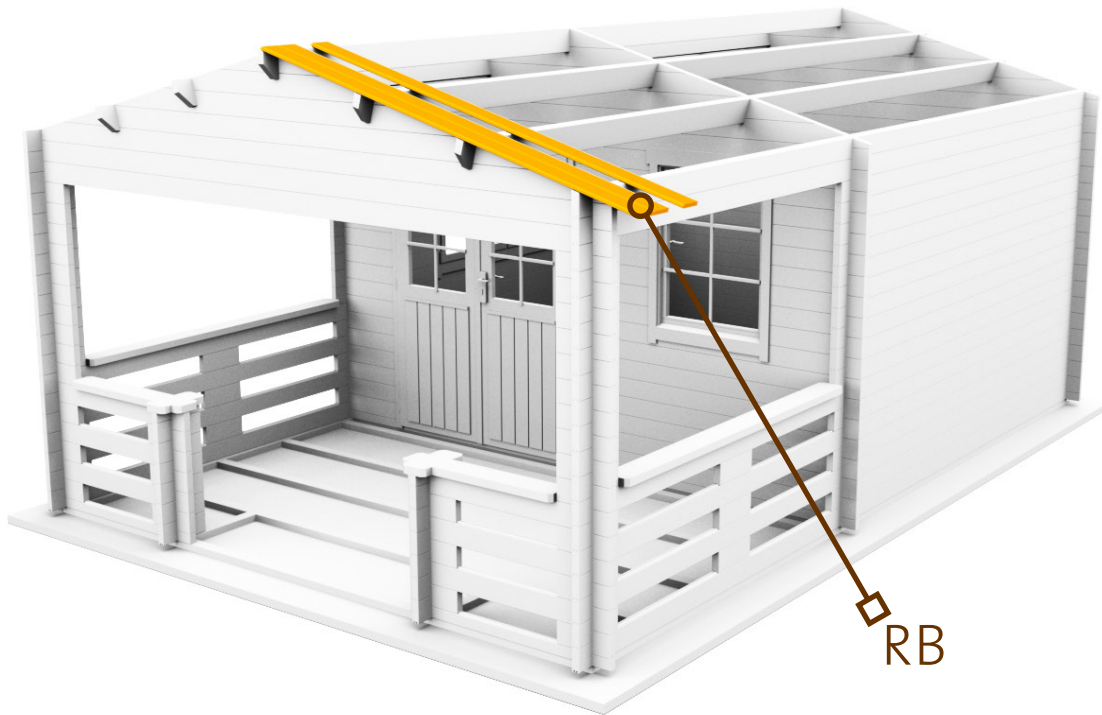
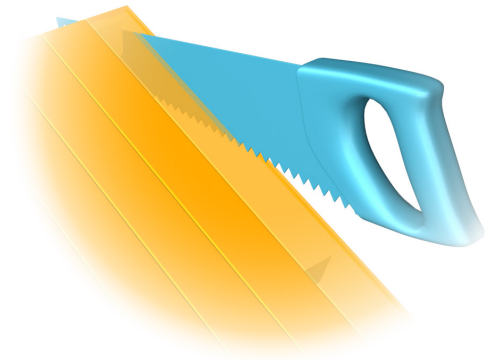
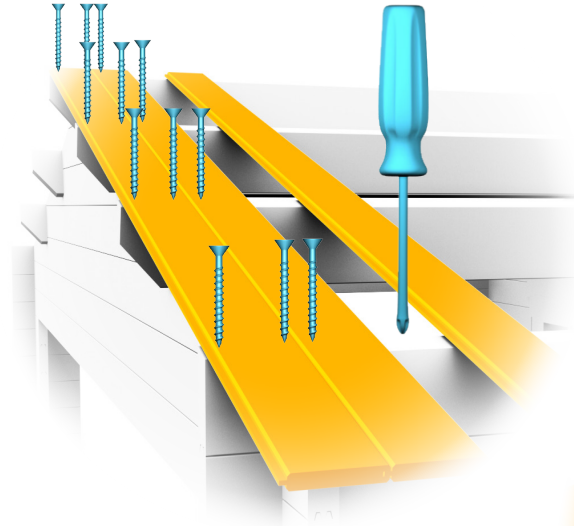

FOR THE FASCIA TRIMS INSERT  
SCREWS AFTER EVERY 0,5 METERS.

LUND 40

4x40  
× 52

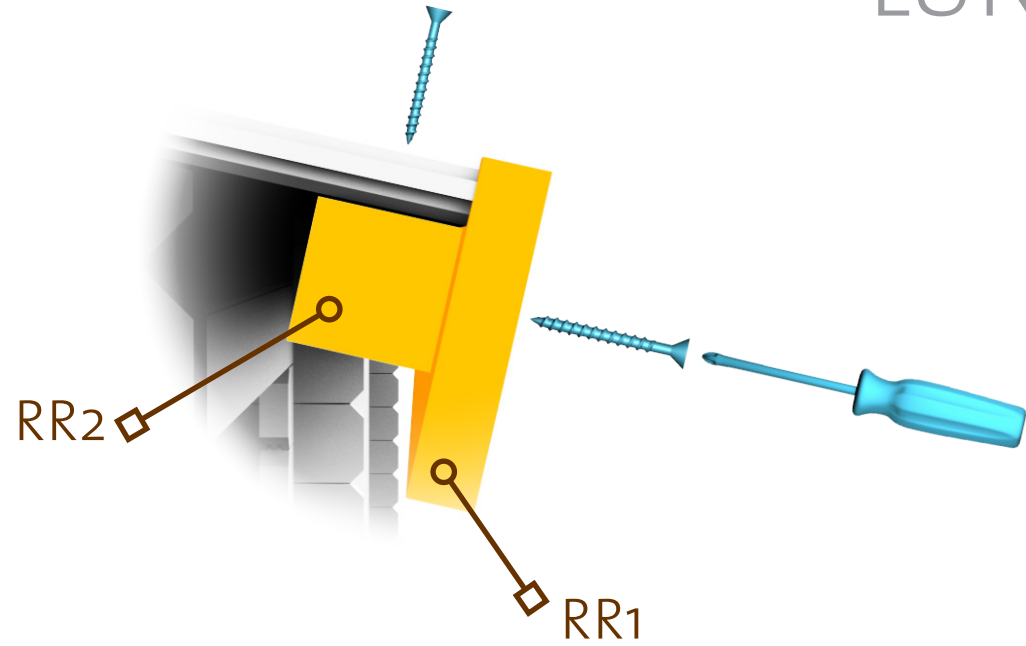



EAVES EDGES GO ON TOP OF THE ROOFING\*.

\*(NOT INCLUDED)

4x40 × 40

Ø 3 mm

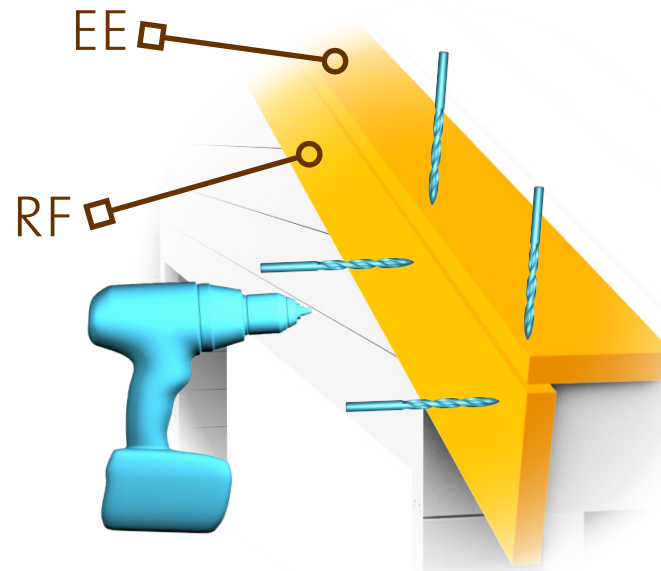

LUND 40

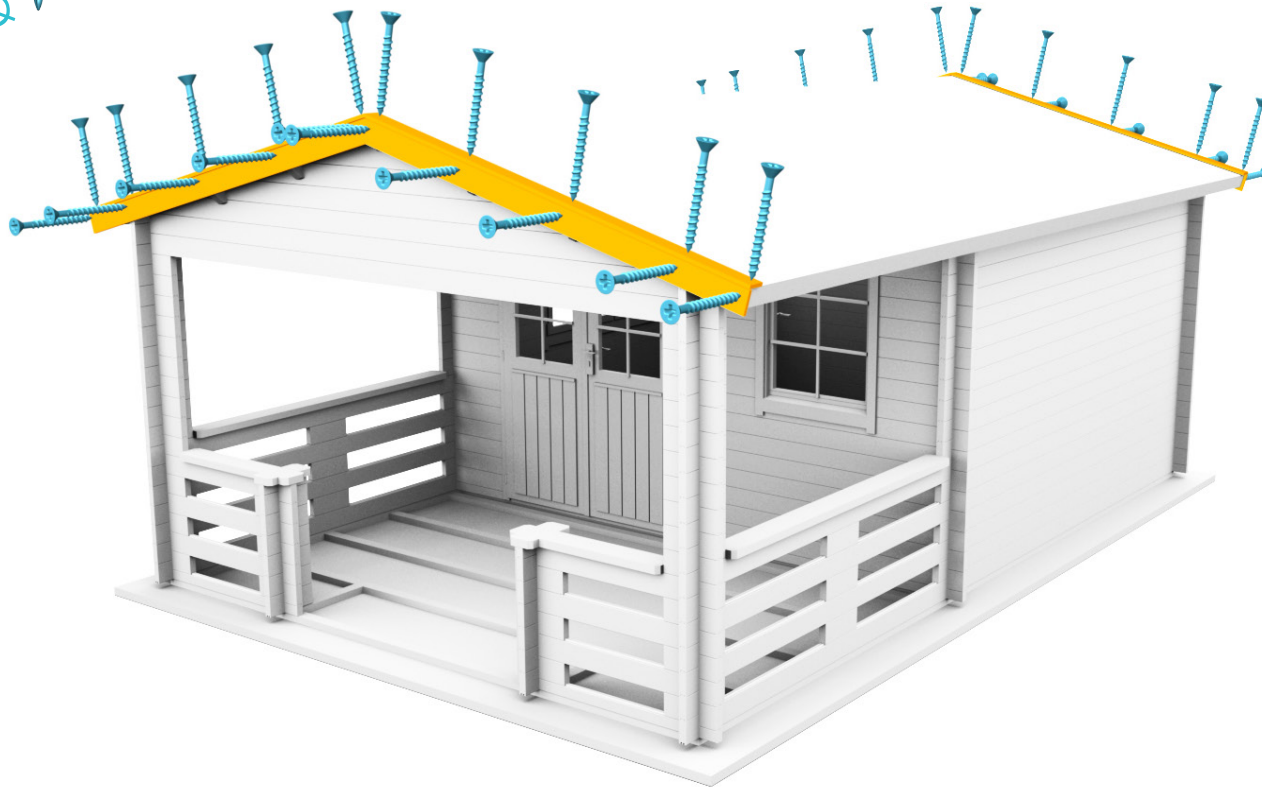
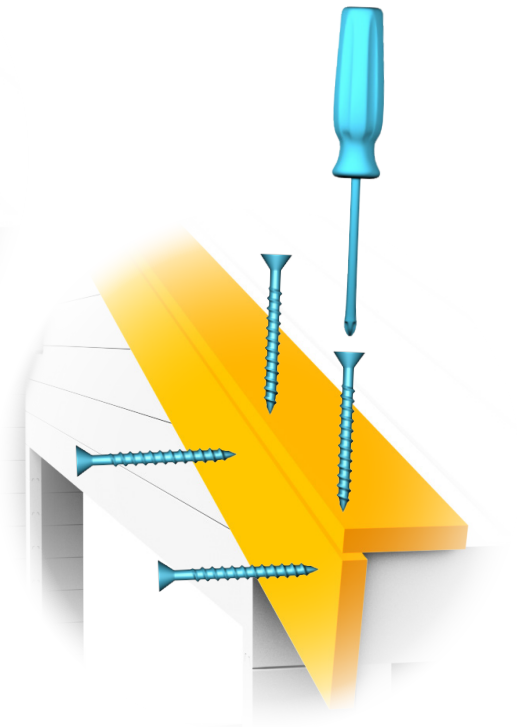

ATTACH ROMBS WITH SCREWS.

LUND 40

$4 \times 40$   
 $\times 4$   
 $\varnothing 3 \text{ mm}$

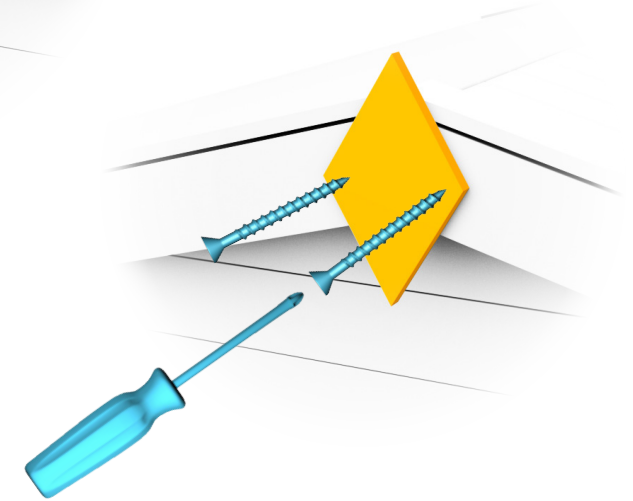
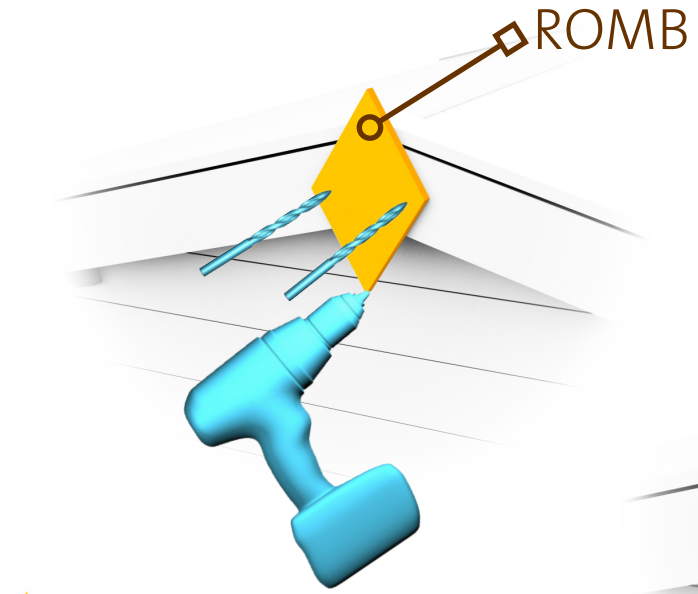

14 SCREWS INTO THE FIRST FLOORBOARD, 7 INTO EACH NEXT, SAW THE LAST BOARD TO MAKE IT FIT.

4x40  
× 252

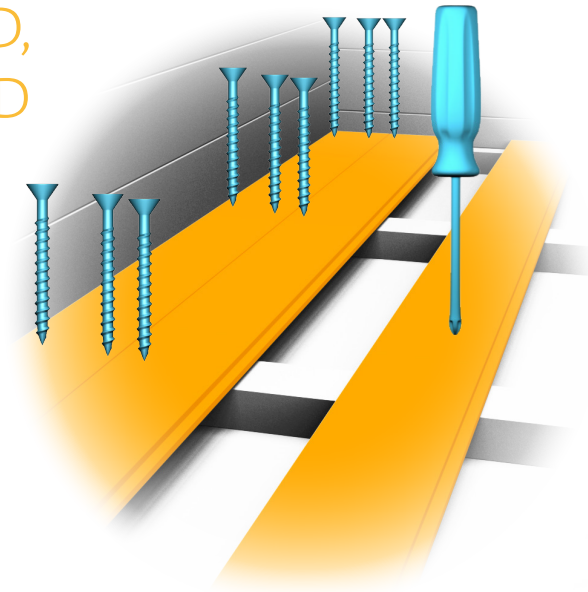

LUND 40

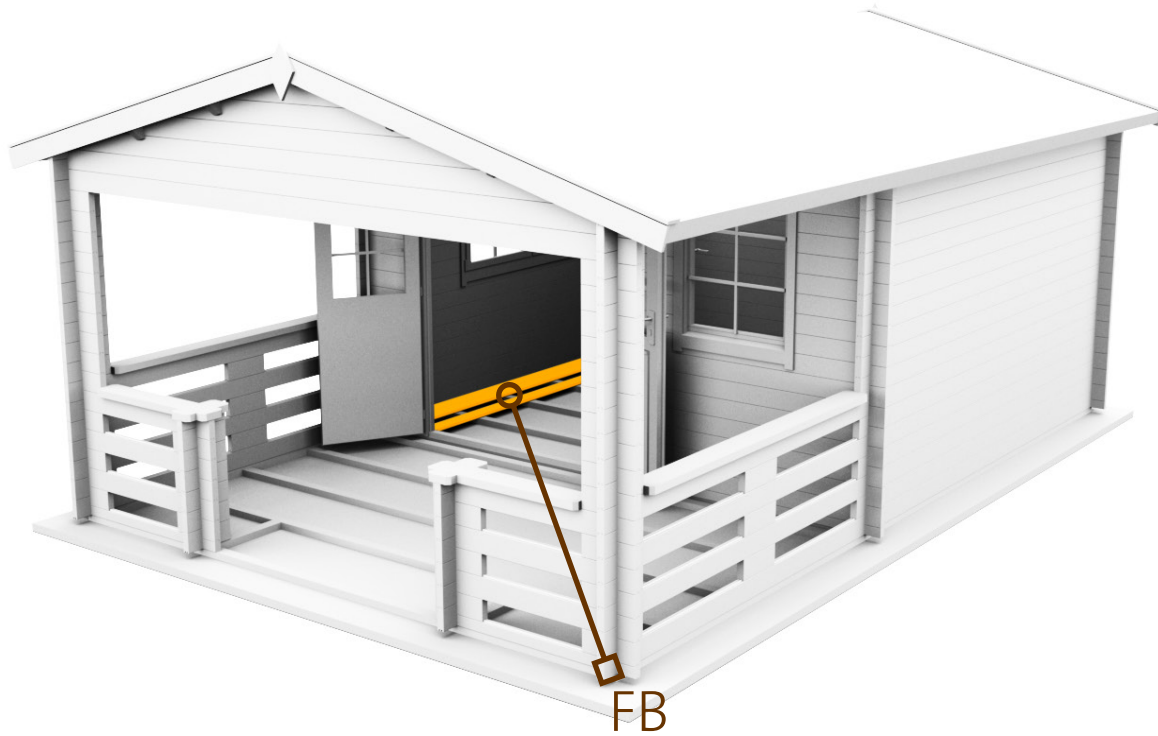
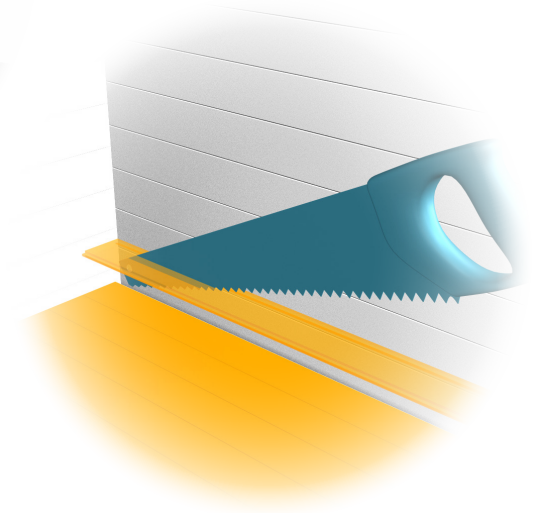

SAW THE **BASEBOARDS**  
AND ATTACH WITH NAILS  
AT **EVERY 0,5** METERS.

1,4×40  
× 35

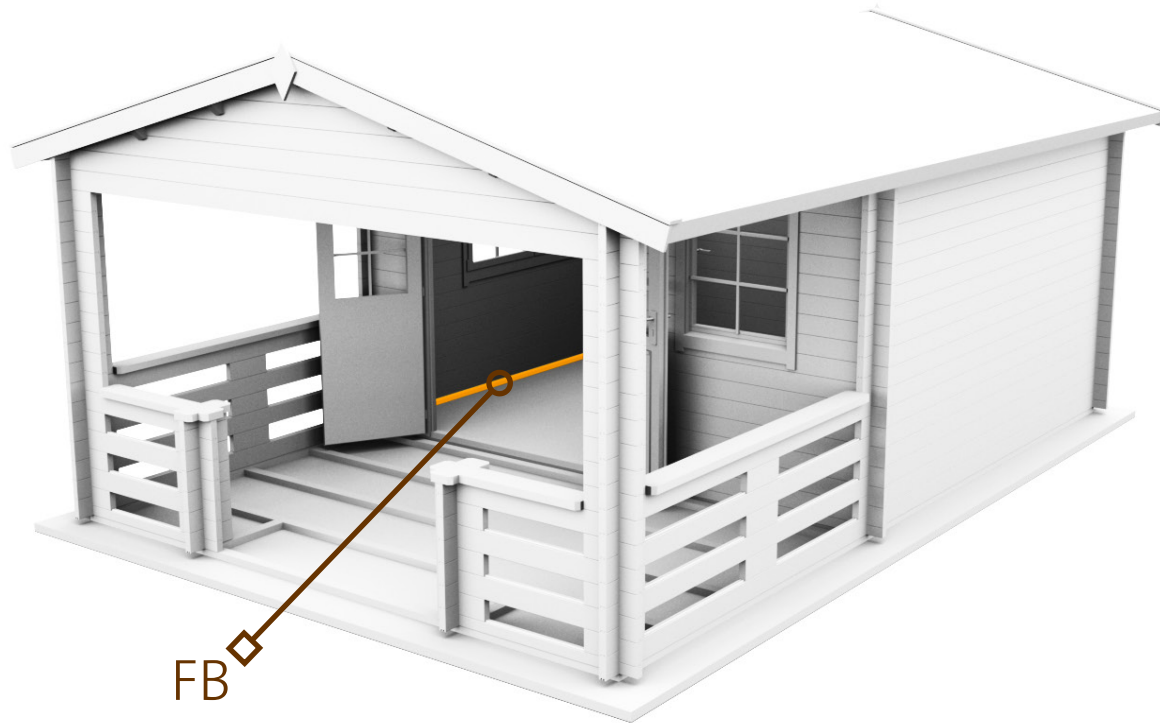
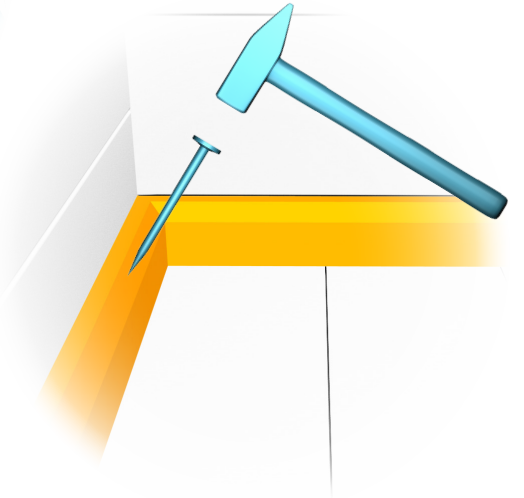
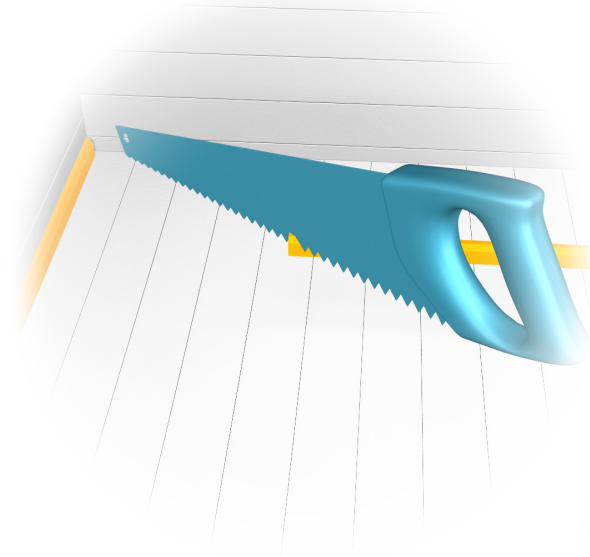

FB

LUND 40

WINDBOARD CONNECTS BOTTOM LOG WITH FIRTS LOG OF THE GABLE.

SAW THE WINDBOARD INTO THE RIGHT LENGTH. FOR THE TOP BOLT, DRILL 8MM HOLE THROUGH THE WINDBOARD.

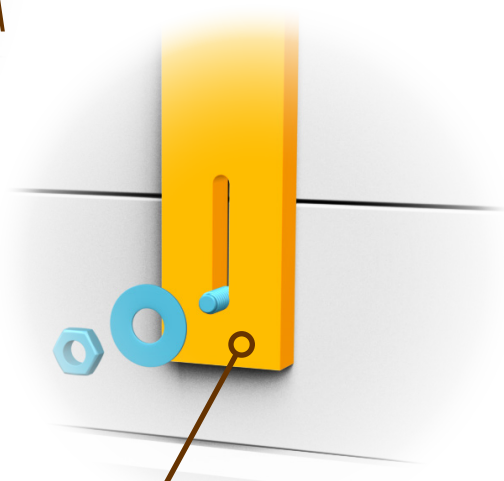
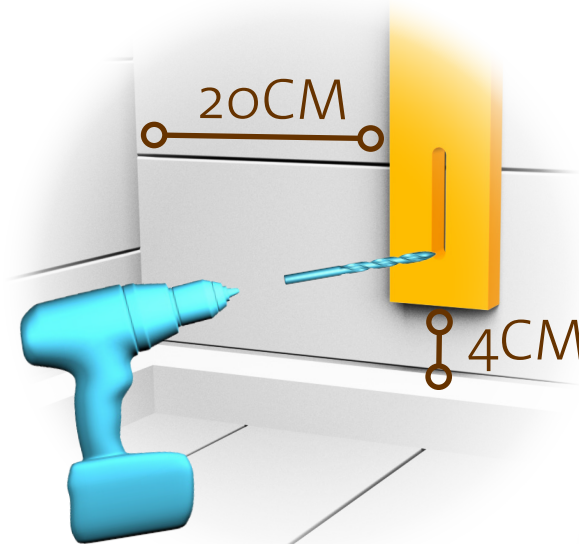
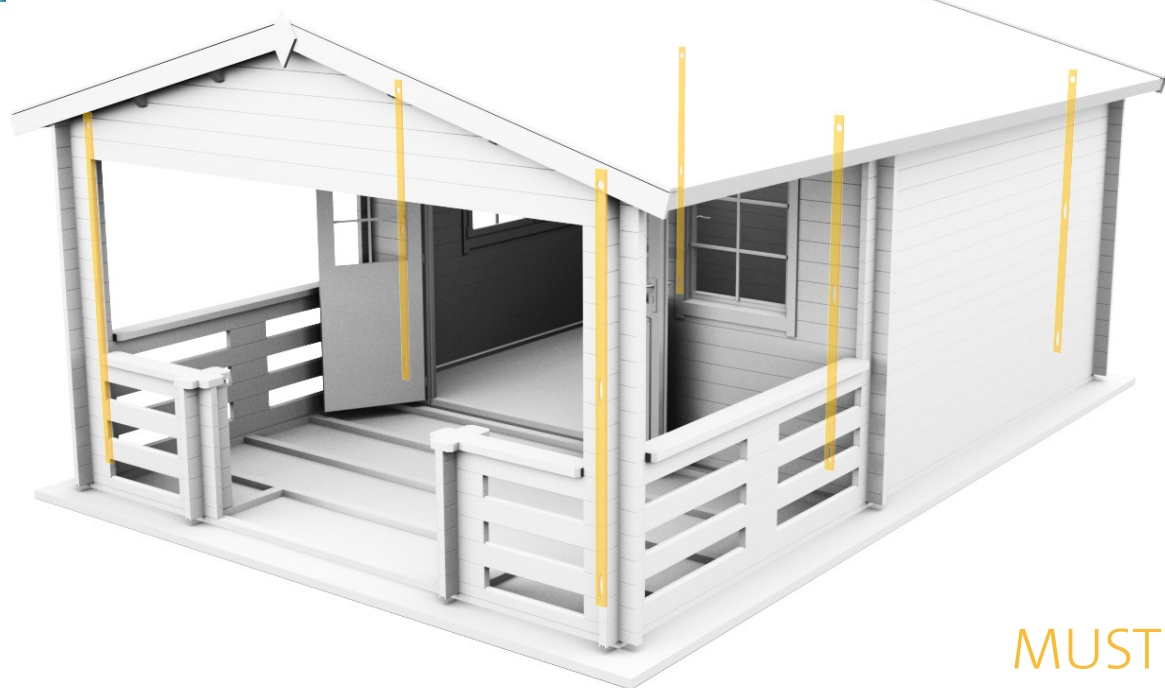
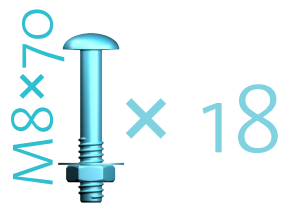
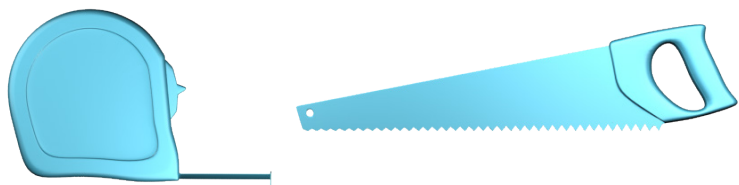

LUND 40

WINDBOARD

DRILL THROUGH THE WALL, HOLE MUST BE AT THE BOTTOM OF THE OVAL, ATTACH WITH BOLTS. 87%

10 SCREWS INTO EACH  
TERRACE BOARD.

4x50  
× 195

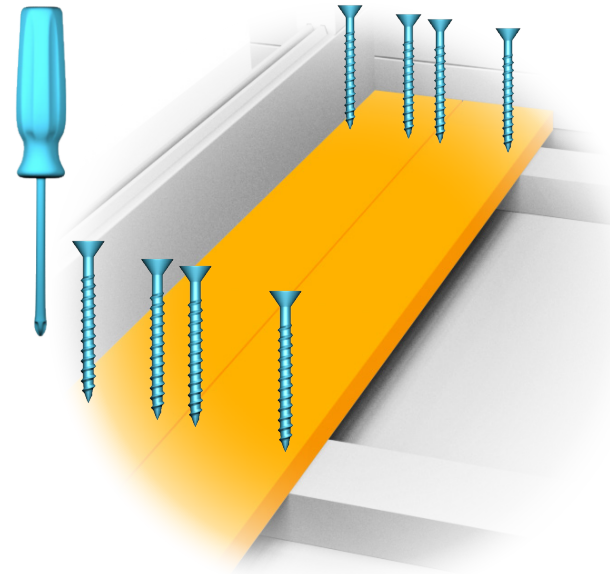

LUND 40

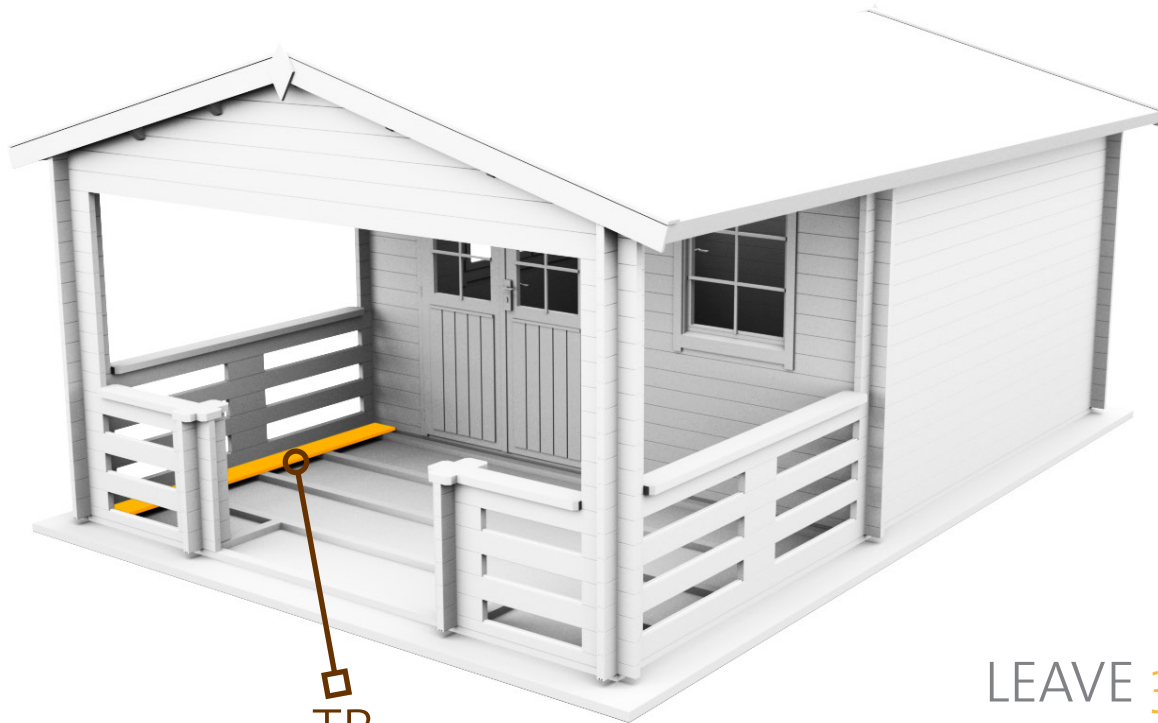
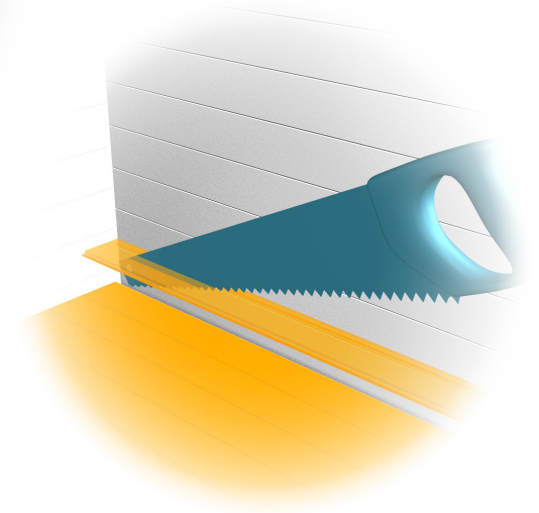

TB

LEAVE 3MM GAP BETWEEN THE BOARDS.  
SAW THE BOARDS IF NEEDED. 88%

IF DOOR IS TILTED,  
PUSH THE DOOR FRAME SO  
THAT ALL CORNERS ARE 90°.

LUND 40

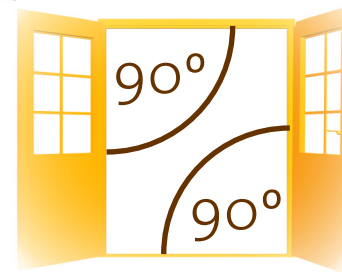
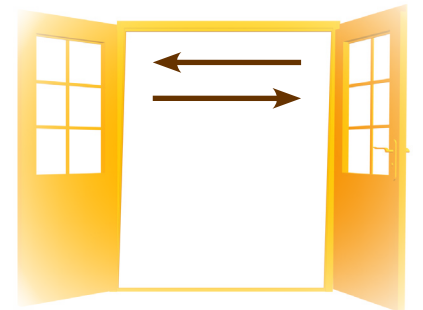

IF **DOORS** ARE IN DIFFERENT HEIGHTS  
OR THERE IS A GAP **BETWEEN** THEM,  
**ADJUST** 3 SCREWS ON DOOR HINGES.

LUND 40

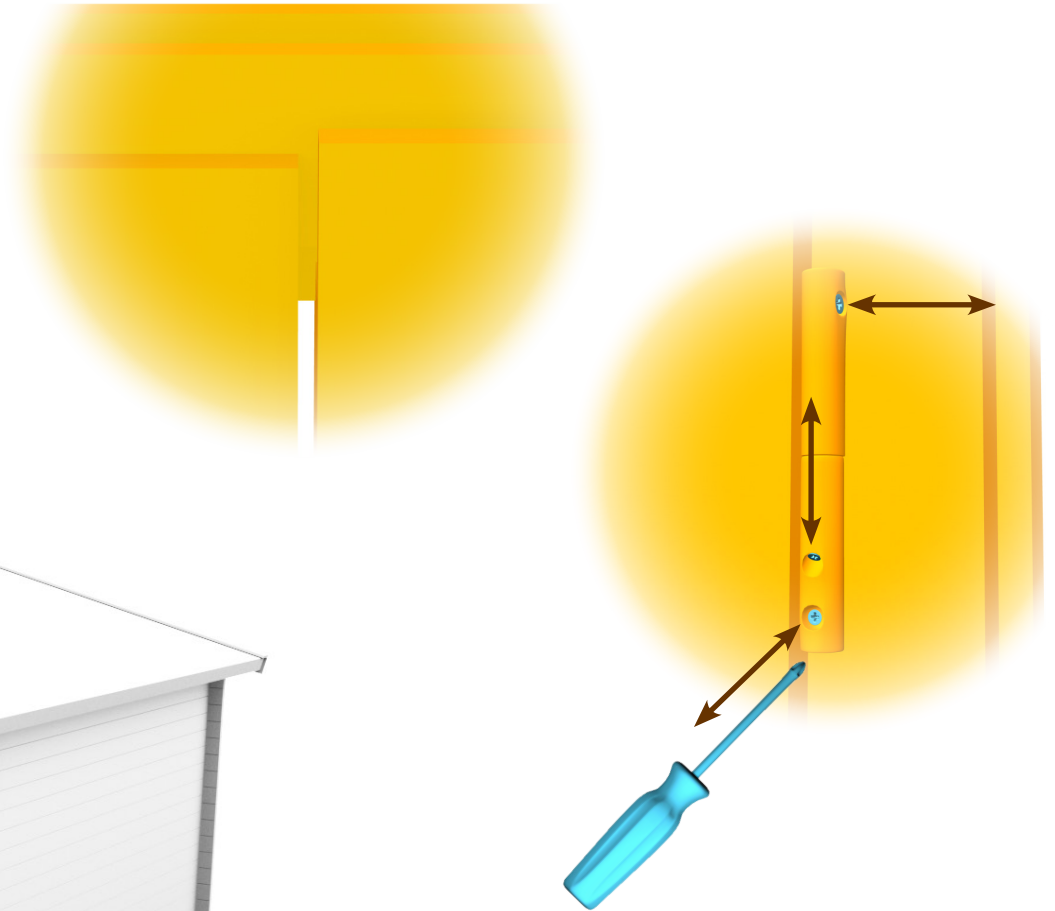
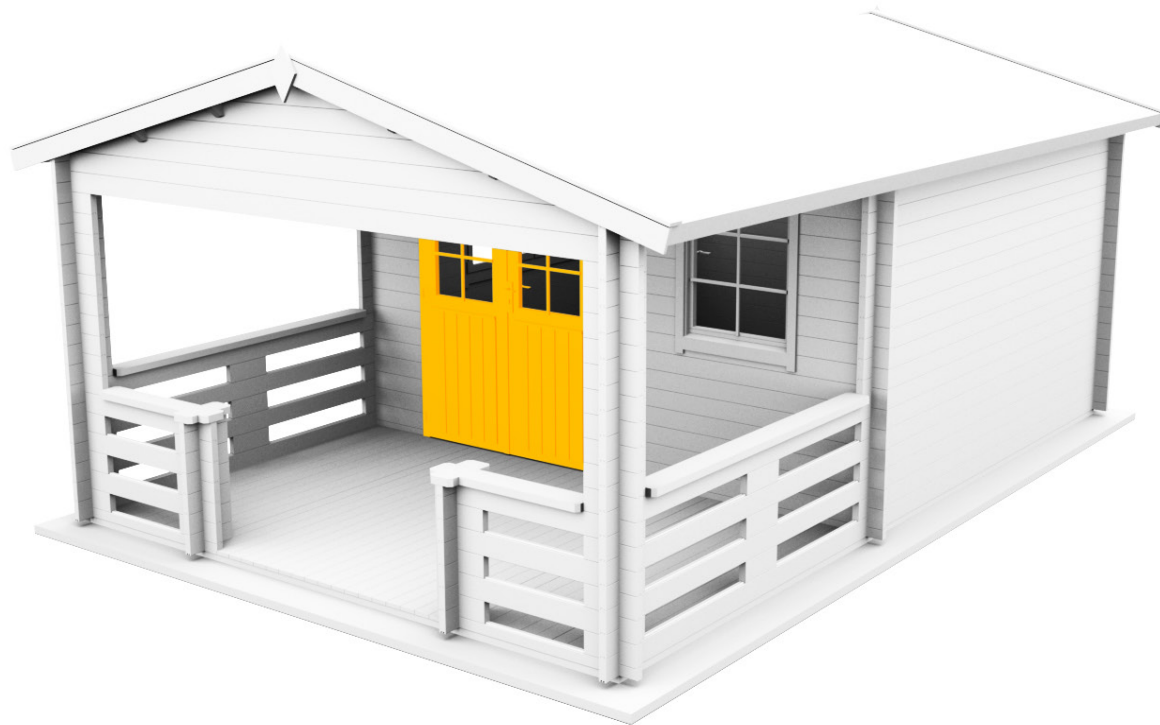



WHEN THE **HOUSE** IS ASSEMBLED, YOU SHOULD **COVER** THE TIMBER WITH **WOOD** PROTECTIVE SEAL, PAINT OR **STAIN** AS SOON AS POSSIBLE TO AVOID DETERIORATION TO THE **WOOD**.

LUND 40

