

Lund 40 (380x575)

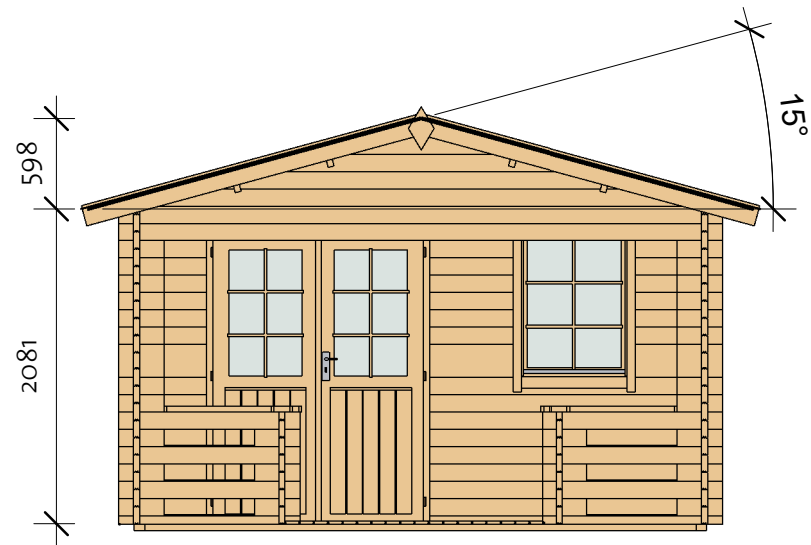

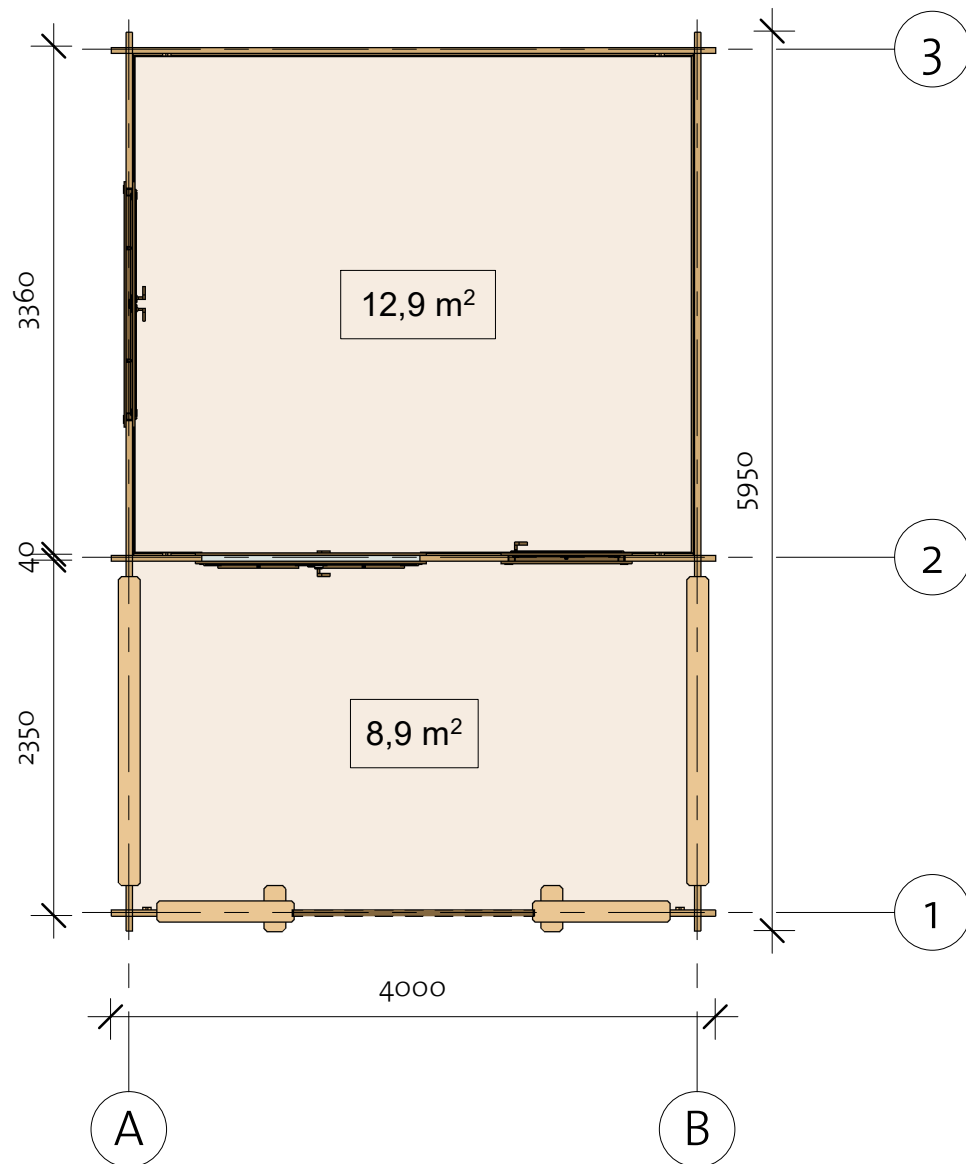

4200029_190408

Lund 40 (380x575)

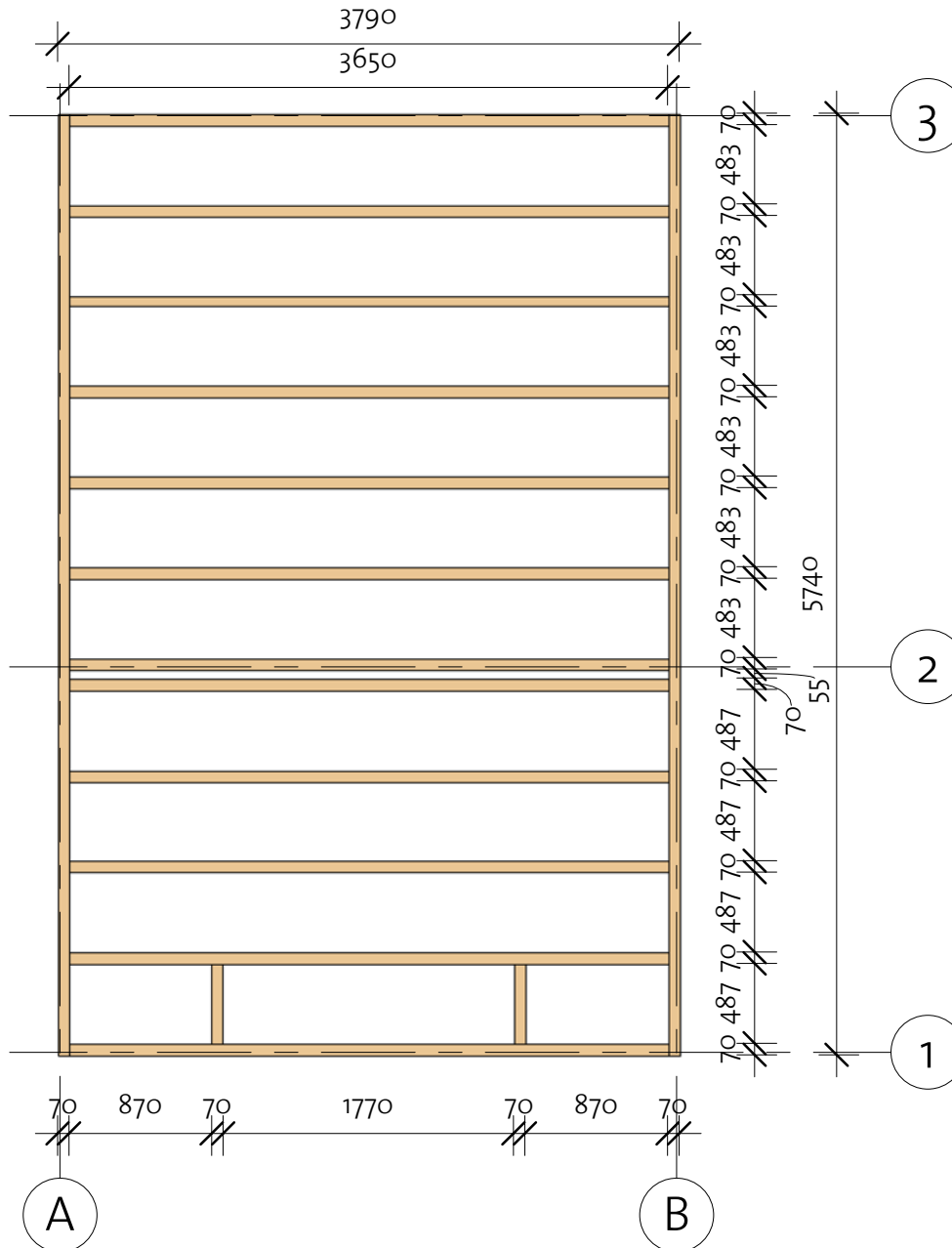
Foundation



Impregnated foundation beams				
Mark	Type	Profile	Count	Length

IFB1	IFB 70x40		2	5740
IFB2	IFB 70x40		12	3650
IFB3	IFB 70x40		2	487

Lund 40 (380x575)

Floor Plan

① Baseboard

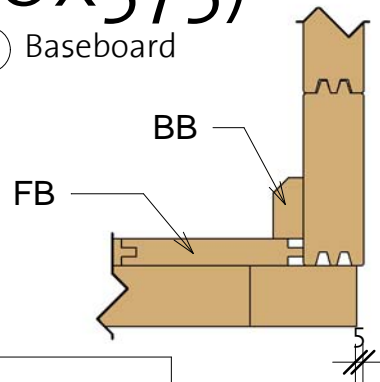

Floor Schedule

Mark	Type	Profile	Count	Length
------	------	---------	-------	--------

FB	FB 18x110		35	3316
TB1	TB 21x95		21	2310
TB2	TB 21x95		18	2350

BB1	BB 20x40		2	3800
BB2	BB 20x40		2	3400

FB
Floorboard

TB 1
Terrace board

TB 2
Terrace board

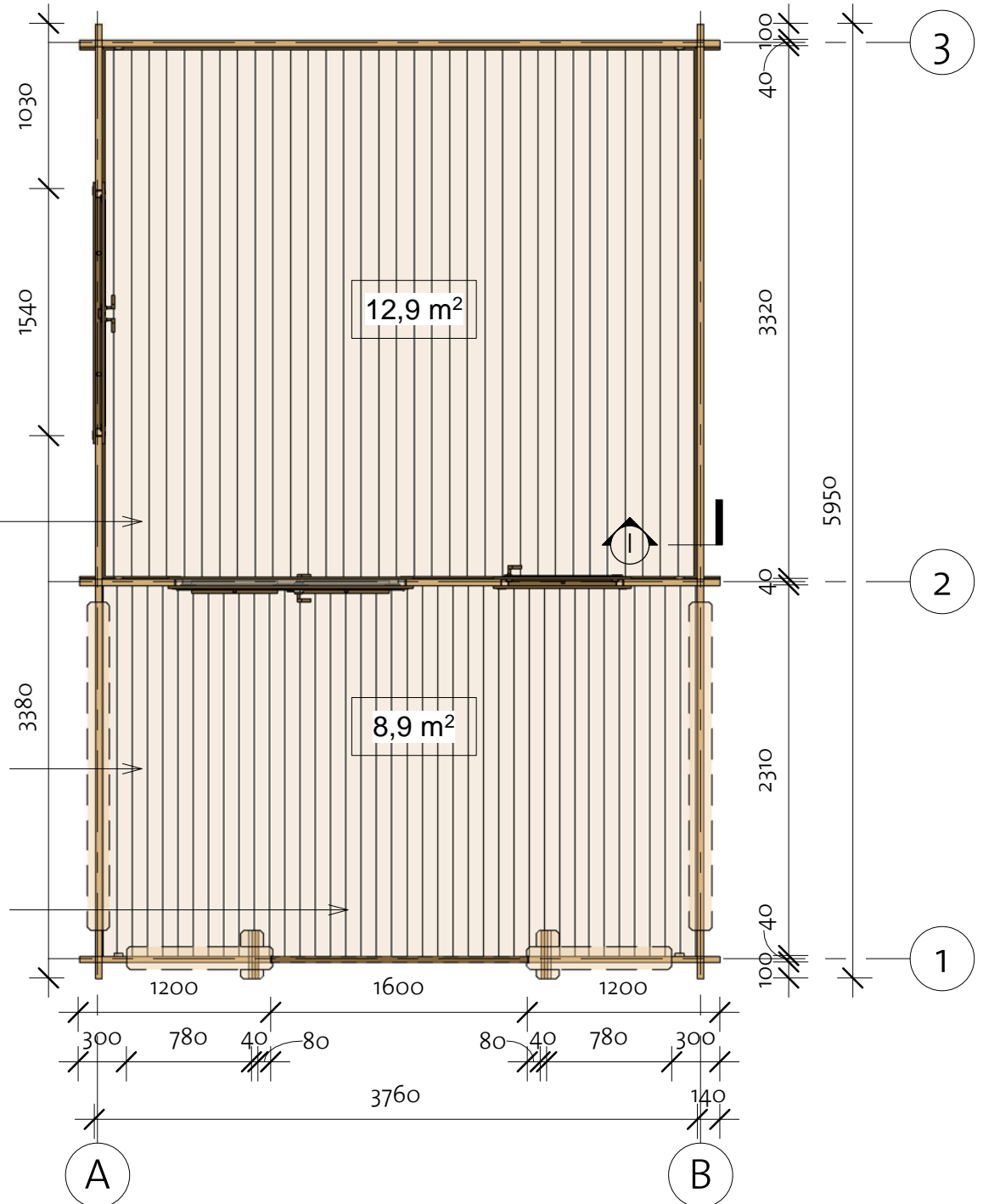

Lund 40 (380x575)

Wall 1

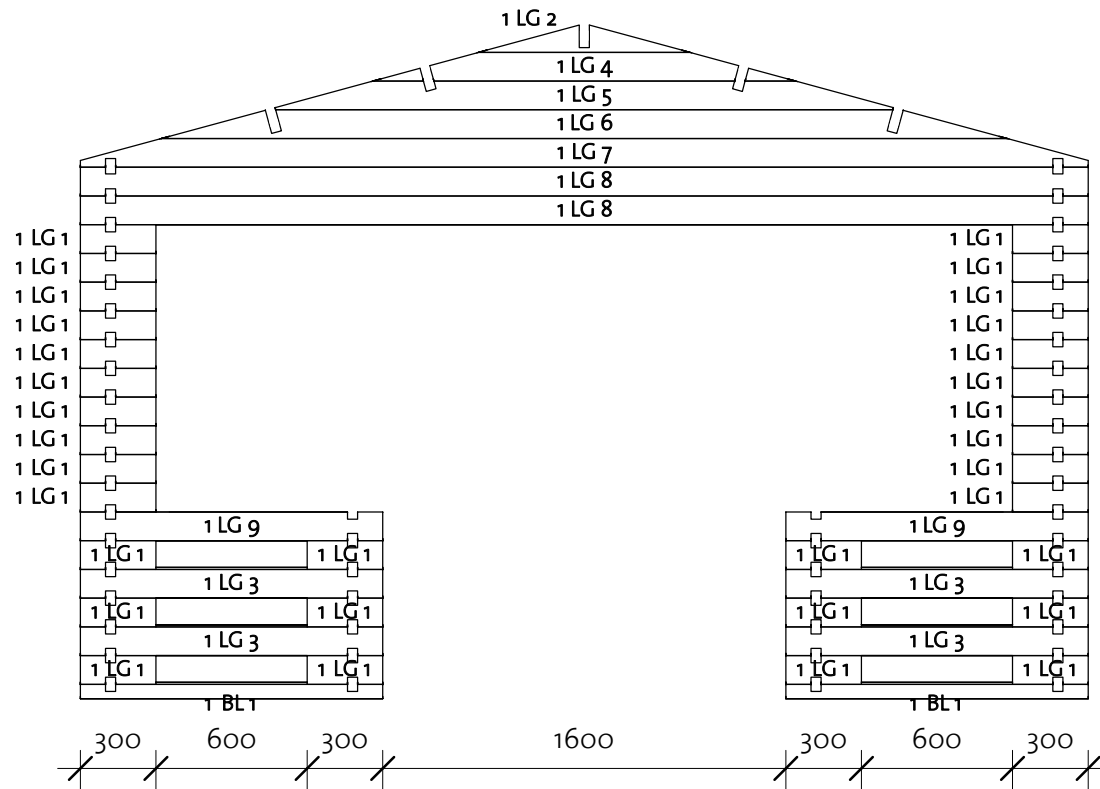
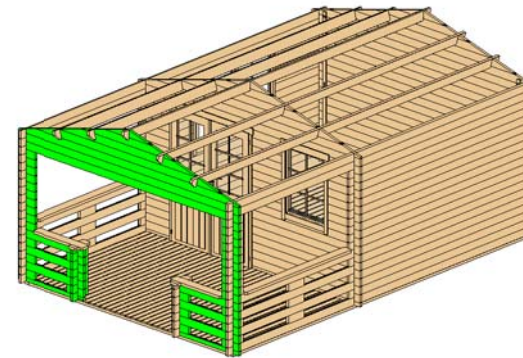



Wall 1			
Mark	Profile	Count	Cut Length

1BL 1	40X57	2	1200
1LG 1	40X114	32	300
1LG 2*	40X114	1	839
1LG 3	40X114	4	1200
1LG 4*	40X114	1	1679
1LG 5*	40X114	1	2454
1LG 6*	40X114	1	3358
1LG 7*	40X114	1	4000
1LG 8	40X114	2	4000
1LG 9	40X114	2	1200

* Gable - delivered premounted

Log Profile Wall 1	
Profile	Profile

40X57	
40X114	

Lund 40 (380x575)

Wall 2

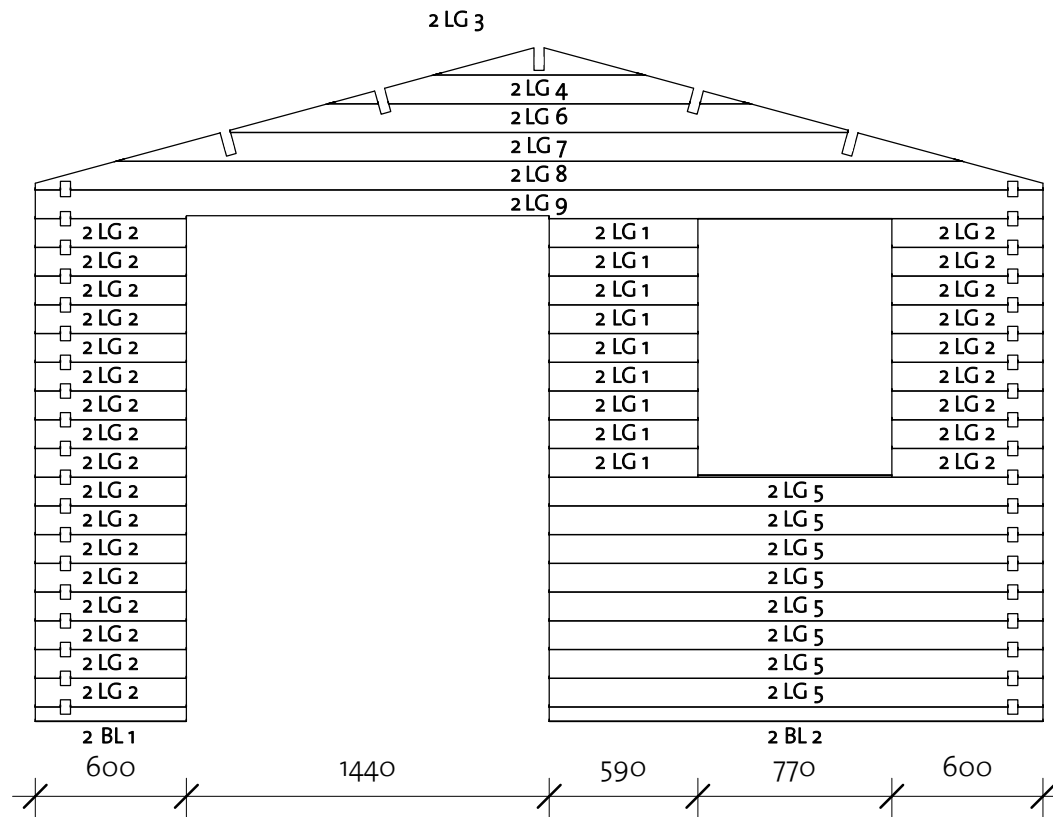
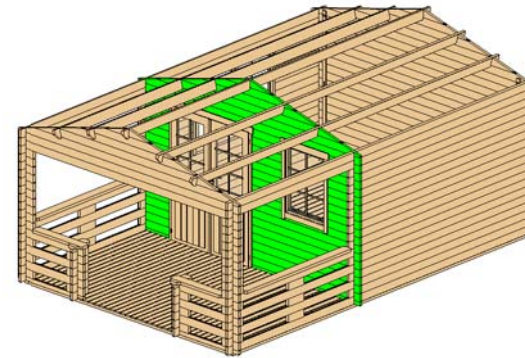

Wall 2			
Mark	Profile	Count	Cut Length

2BL 1	40x57	1	600
2BL 2	40x57	1	1960
2LG 1	40x114	9	590
2LG 2	40x114	26	600
2LG 3*	40x114	1	839
2LG 4*	40x114	1	1679
2LG 5	40x114	8	1960
2LG 6*	40x114	1	2454
2LG 7*	40x114	1	3358
2LG 8*	40x114	1	4000
2LG 9	40x114	1	4000

* Gable - delivered premounted

Log Profile Wall 2	
Profile	Profile

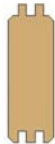
40x57	
40x114	

Lund 40 (380x575)

Wall 3

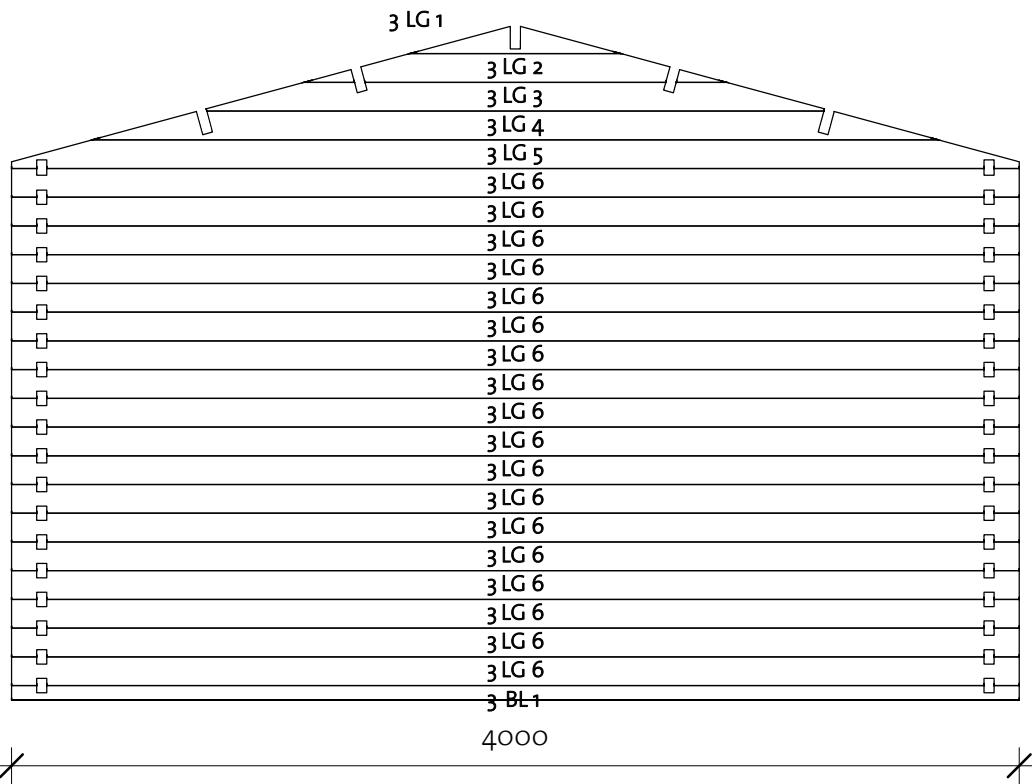
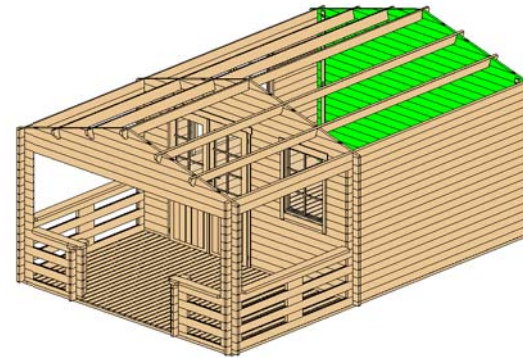



Wall 3			
Mark	Profile	Count	Cut Length

3BL 1	40x57	1	4000
3LG 1 *	40x114	1	839
3LG 2 *	40x114	1	1679
3LG 3 *	40x114	1	2454
3LG 4 *	40x114	1	3358
3LG 5 *	40x114	1	4000
3LG 6	40x114	18	4000

* Gable - delivered premounted

Log Profile Wall 3	
Profile	Profile

40x57	
40x114	

Lund 40 (380x575)

Wall A

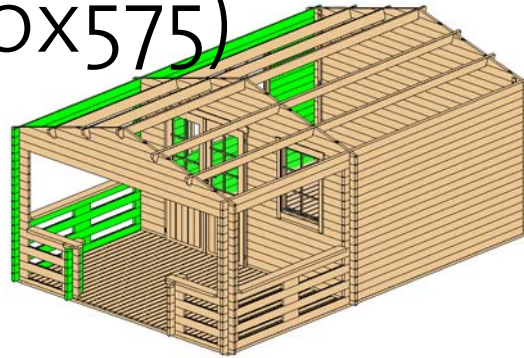

Wall AA			
Mark	Profile	Count	Cut Length

AALG 1	40x114	6	300
AATL 1	40x57	1	300

Wall A			
Mark	Profile	Count	Cut Length

ALG 1	40x114	13	300
ALG 2	40x114	3	300
ALG 3	40x114	18	1030
ALG 4	40x114	4	3600
ALG 5	40x114	4	5950
ALG 6	40x114	1	5950
ATL 1	40x122	1	5950

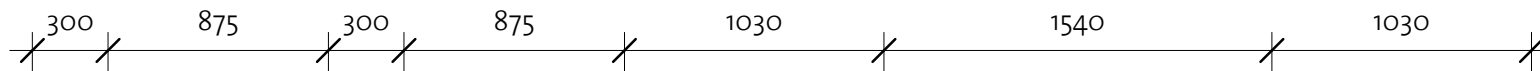
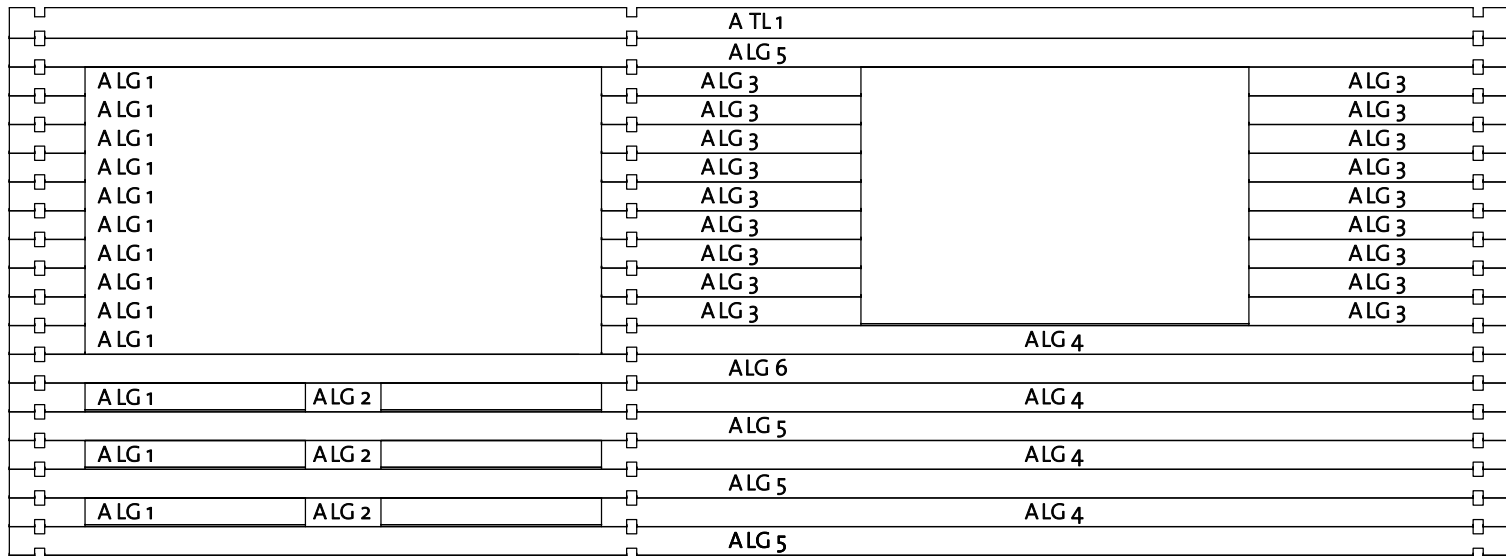
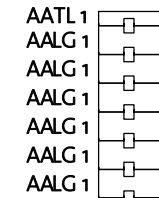

Log Profile Wall A	
Profile	Profile

40x57	
40x114	
40x122	

Lund 40 (380x575)

Wall B

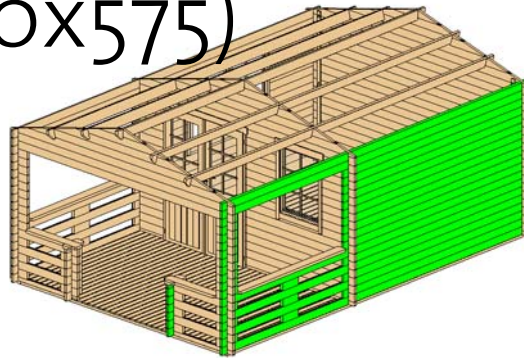

Wall AB			
Mark	Profile	Count	Cut Length

ABLG 1	40x114	6	300
ABTL 1	40x57	1	300

Wall B			
Mark	Profile	Count	Cut Length

BLG 1	40x114	13	300
BLG 2	40x114	3	300
BLG 3	40x114	13	3600
BLG 4	40x114	4	5950
BLG 5	40x114	1	5950
BTL 1	40x122	1	5950

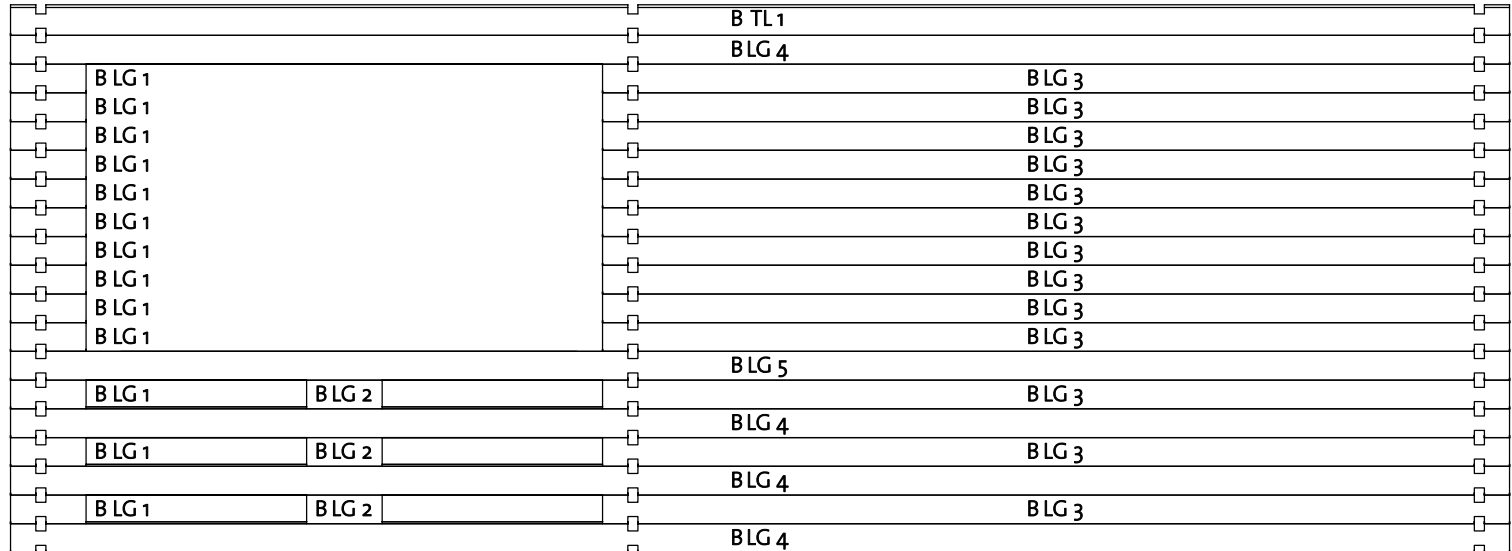
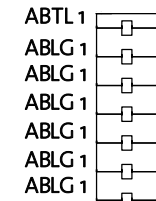





Log Profile Wall B	
Profile	Profile

40x57	
40x114	
40x122	

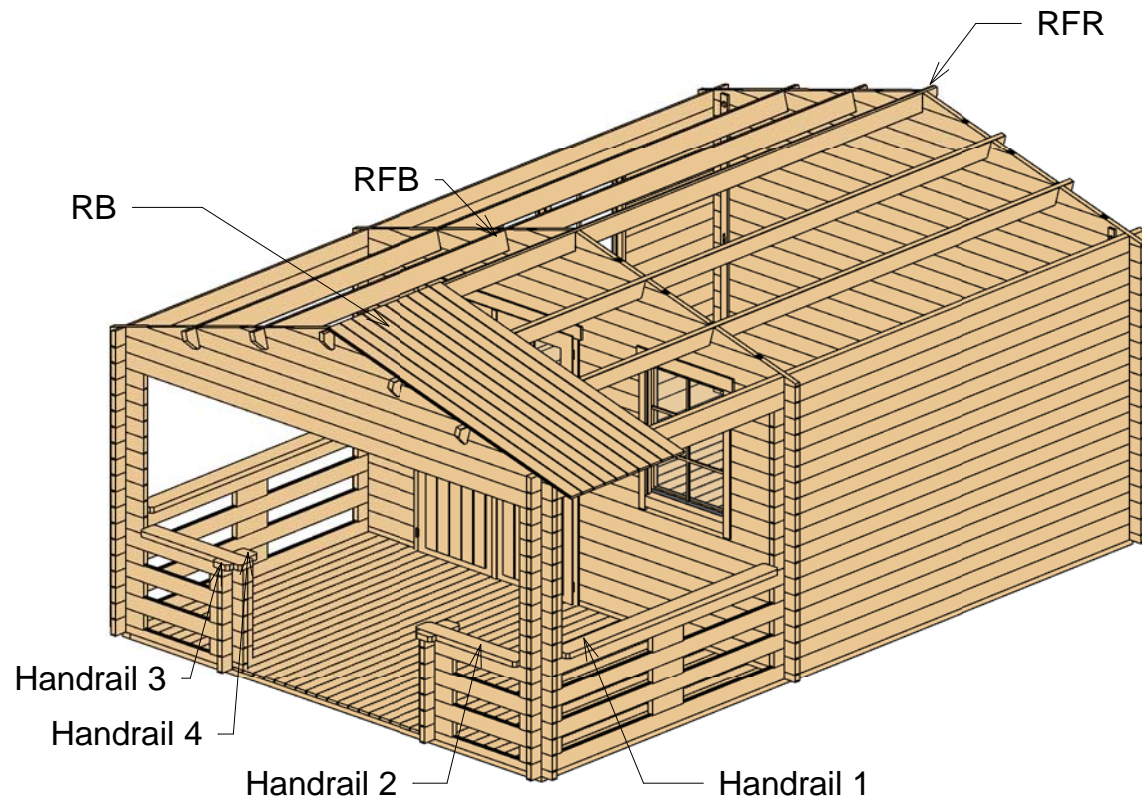
Lund 40 (380x575)

Roof 1



Roof				
Mark	Type	Profile	Count	Length
RFR	Ridge 40x143		1	5950
RFB	Beam 40x143		4	5950
RB	RoofBoard 18x110		110	2280

Type	Profile	Count	Length
------	---------	-------	--------

Handrail 1	40x143	2	2050
Handrail 2	40x143	2	910
Handrail 3	40x143	2	60
Handrail 4	40x143	2	100



Lund 40 (380x575)

Roof 2

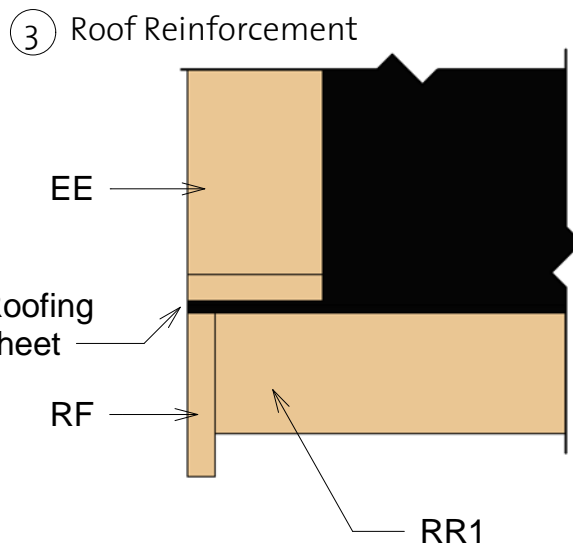
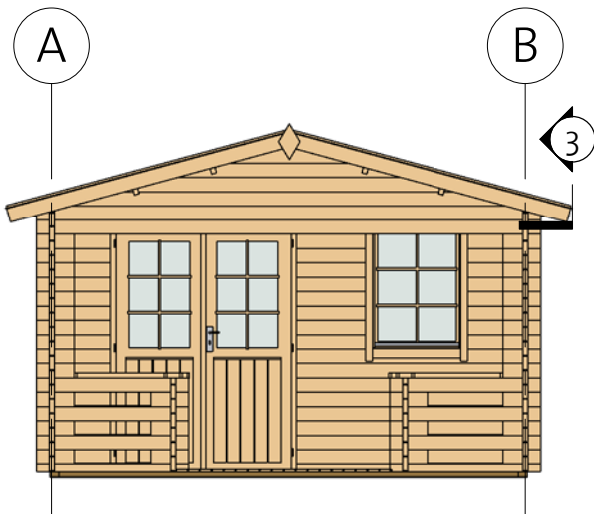
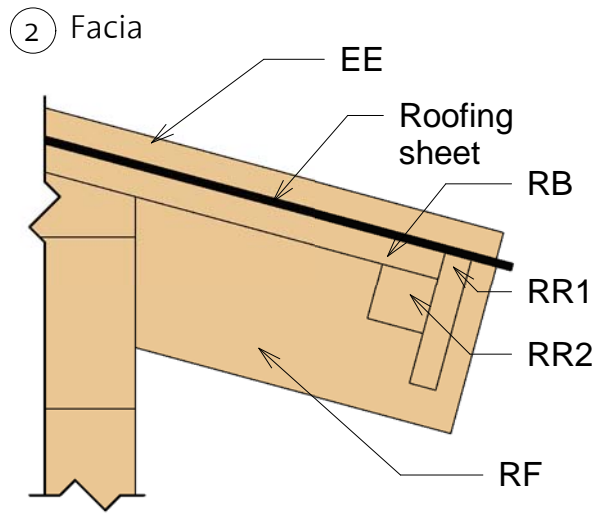
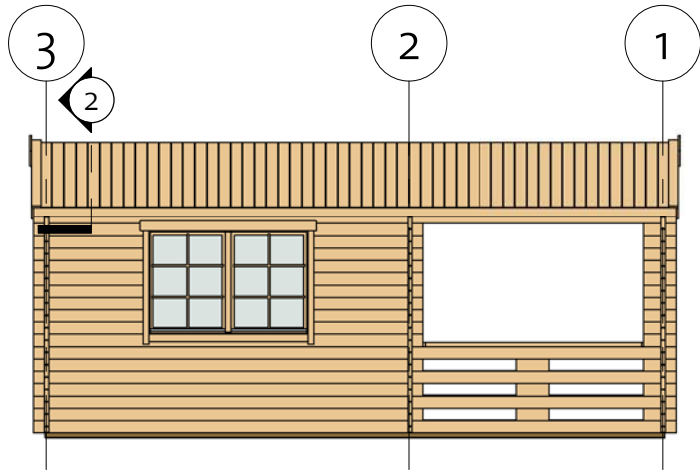

Fascia Schedule				
Mark	Type	Profile	Count	Length
EE	Eave Edging 18x90		4	2320
RF	Facia 18x115		4	2320
RR1	Roof reinforcement 18x90		4	2975
RR2	Roof reinforcement 38x38		4	2975

Lund 40 (380x575)

Extras



Door Schedule				
Model	Type	Width	Height	Count
CDD1	Classic double door 1	1425	1955	1
DCB6	Door crossbar 6	--	--	2
DB	Door beam 1440 mm	40	12	1

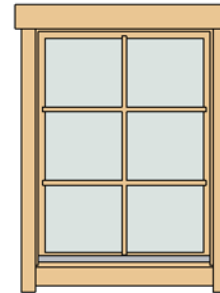

Window Schedule				
Model	Type	Width	Height	Count
CW1L	Classic window 1 left	765	990	1
CDW1	Classic double window 1	1530	990	1
WCB6	Window crossbar 6	--	--	3

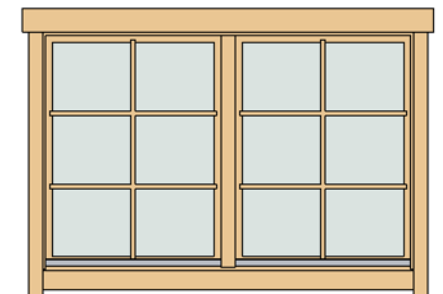

Fasteners/Extras		
Name	Type	Count

Hitblock	300-400 mm	
Bolts	M8 x 70	18
Screws	5,0 x 70	35
Screws	6,0 x 140	75
Screws	4,0 x 40	130
Screws	4,0 x 50	1000

Type	Count	Lenght
Windboard 18x38	6	2150



Type	Count
Romb	2



4200029_190319

Lund 40 (380x575)

List of all items 1



Impregnated foundation beams

Mark	Type	Profile	Count	Length
------	------	---------	-------	--------

IFB1	IFB 70x40		2	5740
IFB2	IFB 70x40		12	3650
IFB3	IFB 70x40		2	487

Floor Schedule





Mark	Type	Profile	Count	Length
------	------	---------	-------	--------

FB	FB 18x110		35	3316
TB1	TB 21x95		21	2310
TB2	TB 21x95		18	2350

BB1	BB 20x40		2	3800
BB2	BB 20x40		2	3400



Fascia Schedule

Mark	Type	Profile	Count	Length
------	------	---------	-------	--------

EE	Eave Edging 18x90		4	2320
RF	Facia 18x115		4	2320
RR1	Roof reinforcement 18x90		4	2975
RR2	Roof reinforcement 38x38		4	2975

Roof

Mark	Type	Profile	Count	Length
------	------	---------	-------	--------

RFR	Ridge 40x143		1	5950
RFB	Beam 40x143		4	5950
RB	RoofBoard 18x110		110	2280

Lund 40 (380x575)

List of all items 2

Wall 1			
Mark	Profile	Count	Cut Length

1BL 1	40x57	2	1200
1LG 1	40x114	32	300
1LG 2*	40x114	1	839
1LG 3	40x114	4	1200
1LG 4*	40x114	1	1679
1LG 5*	40x114	1	2454
1LG 6*	40x114	1	3358
1LG 7*	40x114	1	4000
1LG 8	40x114	2	4000
1LG 9	40x114	2	1200

Wall 2			
Mark	Profile	Count	Cut Length



2BL 1	40x57	1	600
2BL 2	40x57	1	1960
2LG 1	40x114	9	590
2LG 2	40x114	26	600
2LG 3*	40x114	1	839
2LG 4*	40x114	1	1679
2LG 5	40x114	8	1960
2LG 6*	40x114	1	2454
2LG 7*	40x114	1	3358
2LG 8*	40x114	1	4000
2LG 9	40x114	1	4000

*Gable-delivered premounted

Wall 3			
Mark	Profile	Count	Cut Length

3BL 1	40x57	1	4000
3LG 1*	40x114	1	839
3LG 2*	40x114	1	1679
3LG 3*	40x114	1	2454
3LG 4*	40x114	1	3358
3LG 5*	40x114	1	4000
3LG 6	40x114	18	4000

Log Profiles 1	
Profile	Profile

40x57	
40x114	

Lund 40 (380x575)

List of all items 3

Wall A			
Mark	Profile	Count	Cut Length

ALG 1	40X114	13	300
ALG 2	40X114	3	300
ALG 3	40X114	18	1030
ALG 4	40X114	4	3600
ALG 5	40X114	4	5950
ALG 6	40X114	1	5950
ATL 1	40X122	1	5950

Wall B			
Mark	Profile	Count	Cut Length

BLG 1	40X114	13	300
BLG 2	40X114	3	300
BLG 3	40X114	13	3600
BLG 4	40X114	4	5950
BLG 5	40X114	1	5950
BTL 1	40X122	1	5950



Wall AA			
Mark	Profile	Count	Cut Length

AALG 1	40X114	6	300
AATL 1	40X57	1	300

Wall AB			
Mark	Profile	Count	Cut Length

ABLG 1	40X114	6	300
ABTL 1	40X57	1	300

Log Profiles 2	
Profile	Profile

40X57	
40X114	
40X122	