

Techn. Daten: Göteborg A

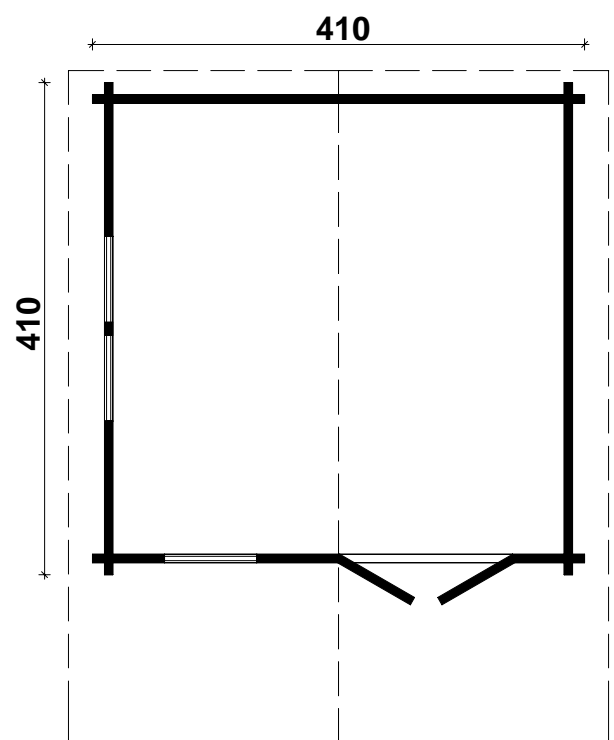

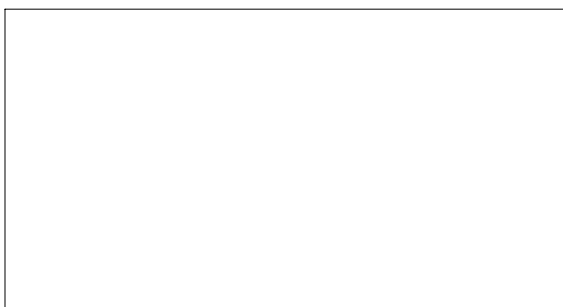







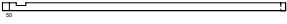

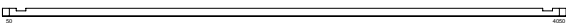
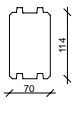





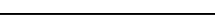
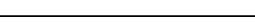
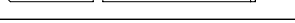

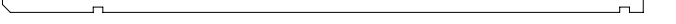
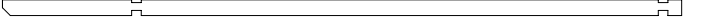
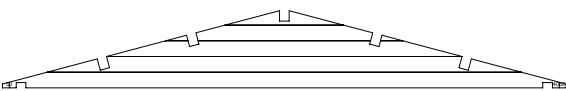
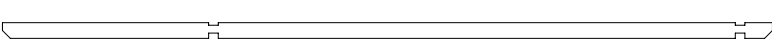
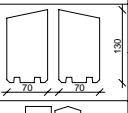
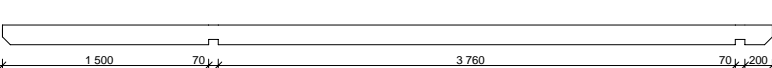
Bohlenaußenmaß (B x T): 410 x 410 cm

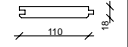
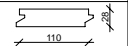
Wandaußenmaß: 390 x 390 cm - Bohlenstärke: 70 mm

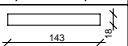

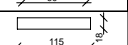
Achtung : Alle angegebenen Maße sind ca. - Maße !

Teilleiste Göteborg A 70 mm - 410 x 410 cm

Nr.	Beschreibung	Profil mm	Länge mm	Stück	
001	Fundamenthölzer		3870	2	
002			3730	8	
003			2060	1	
004			600	1	
005			4100	1	
006			4100	19	
007			4100	22	
008			2060	8	
009			1280	15	
010			600	26	
011			690	9	
012			1560	1	
013			1840	1	
014			2120	1	
015			4380	1	
016			4660	1	
017			4940	1	
018			5220	2	
019			--	--	
020				4100	2
021				5600	2(1+1)
022				5600	5(4+1)
023	Dachpappe			--	--
024	Dachbretter		2320	102+2	
025	Fußbodenbretter		3757	35+1	
026	Giebelblende 		2370	4	
027	Giebelabschlussbrett		2370	4	
028	Traufenbrett		5600	2	
029	Traufenleiste		5600	2	
030	Raute			2	
031	Fußleisten		ca. 15,1 m		
032	Gewindestange		2200	4	
033	Schrauben 4,0 x 40; 5,0 x 70; 5,0 x 100			1 Beutel	
034	Schrauben 4,0 x 50			1 Beutel	
035	Dachpappnägel 3,0 x 15			--	
036	Mutter, Scheibe			8	

Göteborg A 70 mm - 410 x 410 cm

Fundamentplan

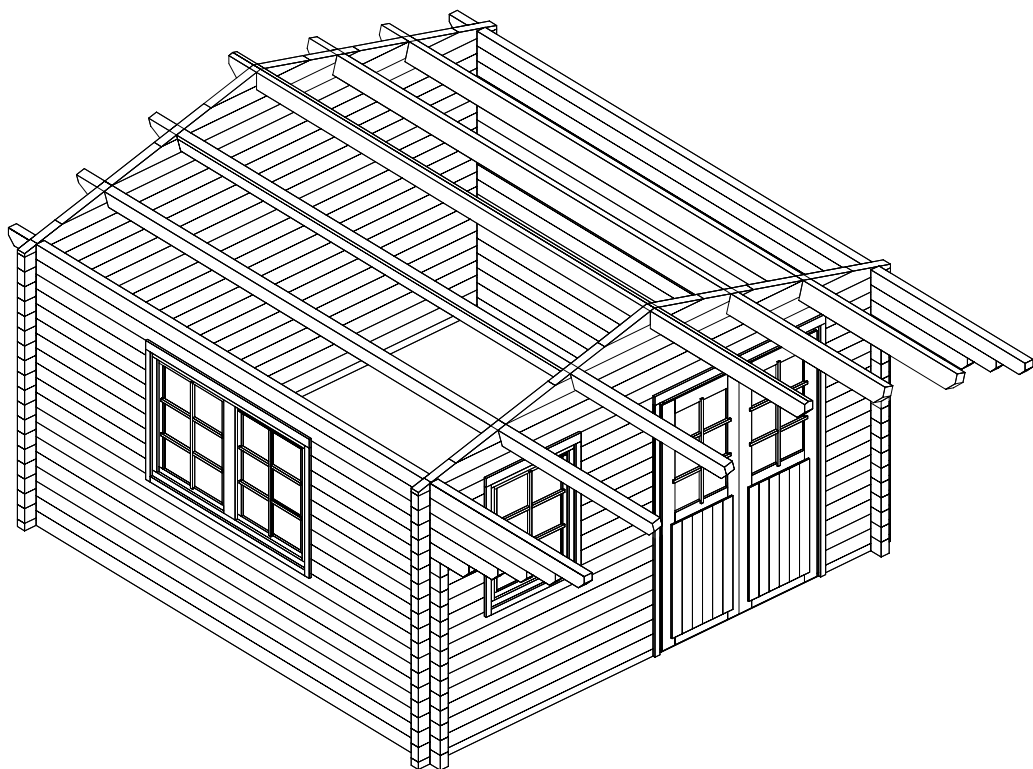
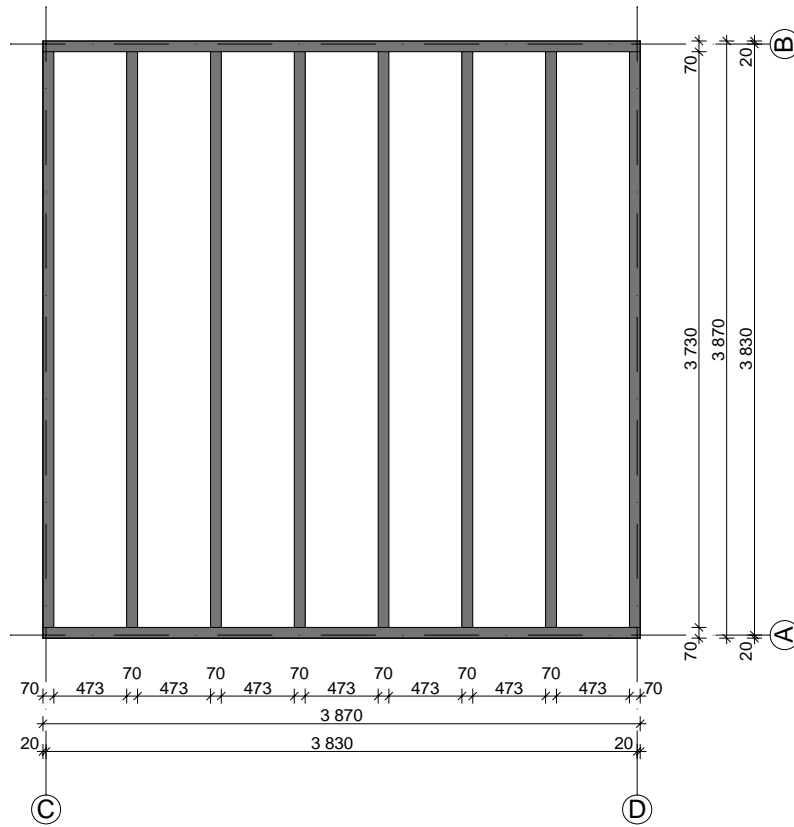

Göteborg A 70 mm - 410 x 410 cm

Wandplan

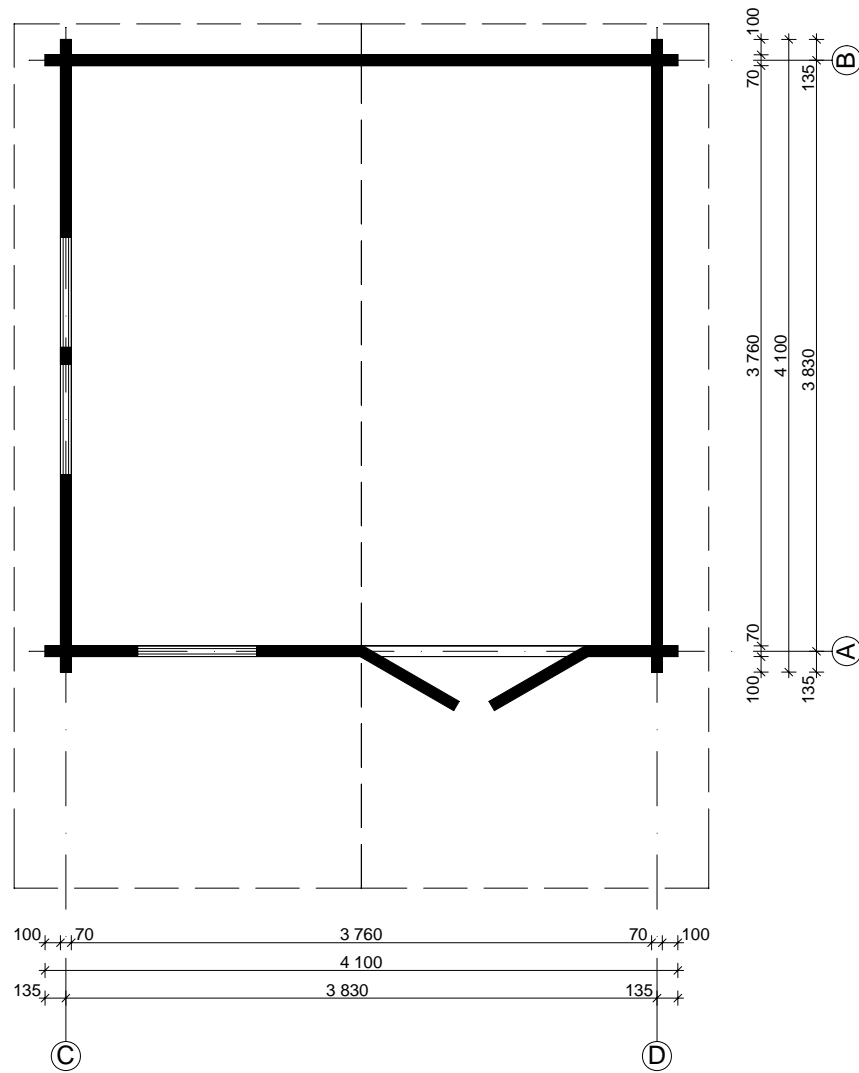

Wandplan Göteborg A 70 mm - 410 x 410 cm

Wand A

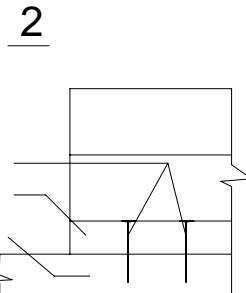
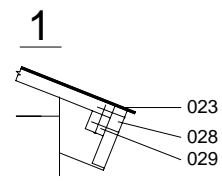
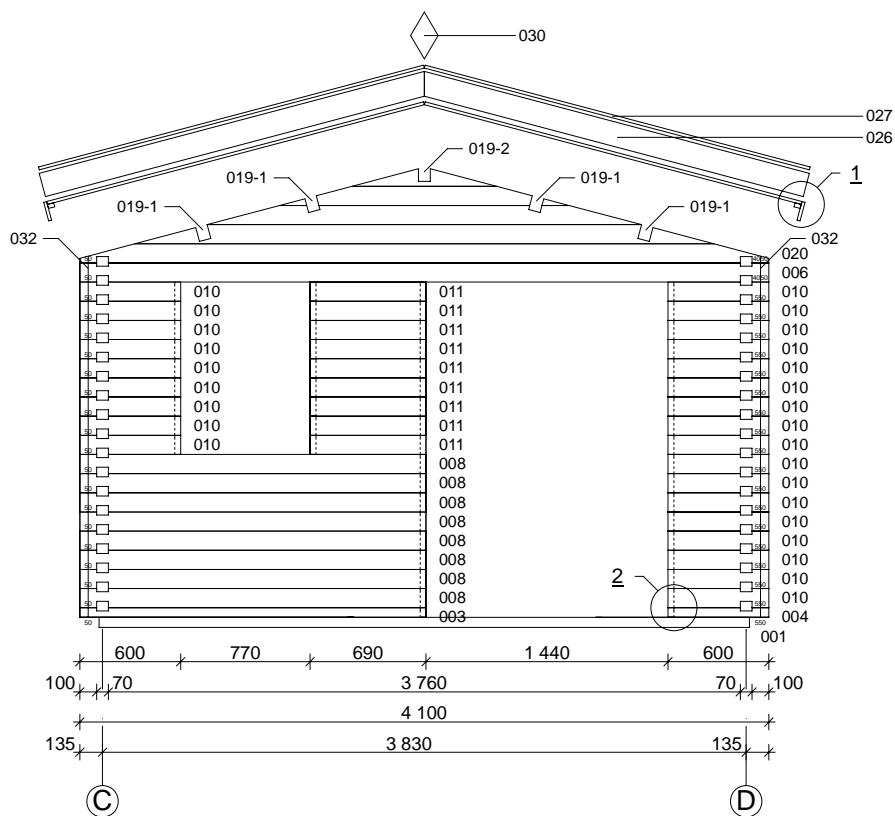

A-A

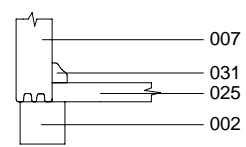

B-B

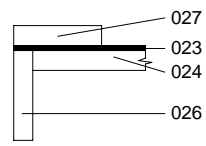

Wand B

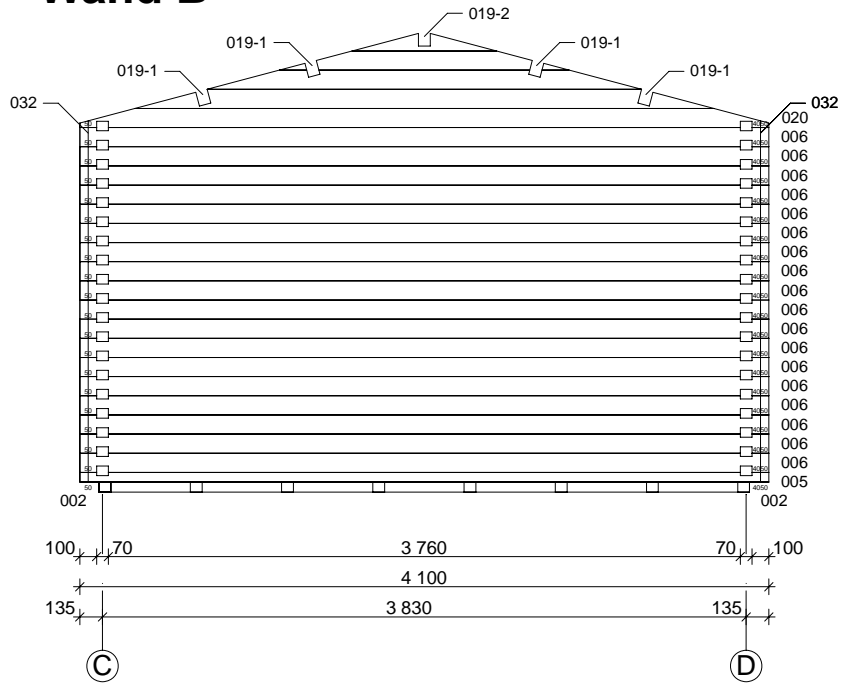

Wandplan Göteborg A 70 mm - 410 x 410 cm

Wand C

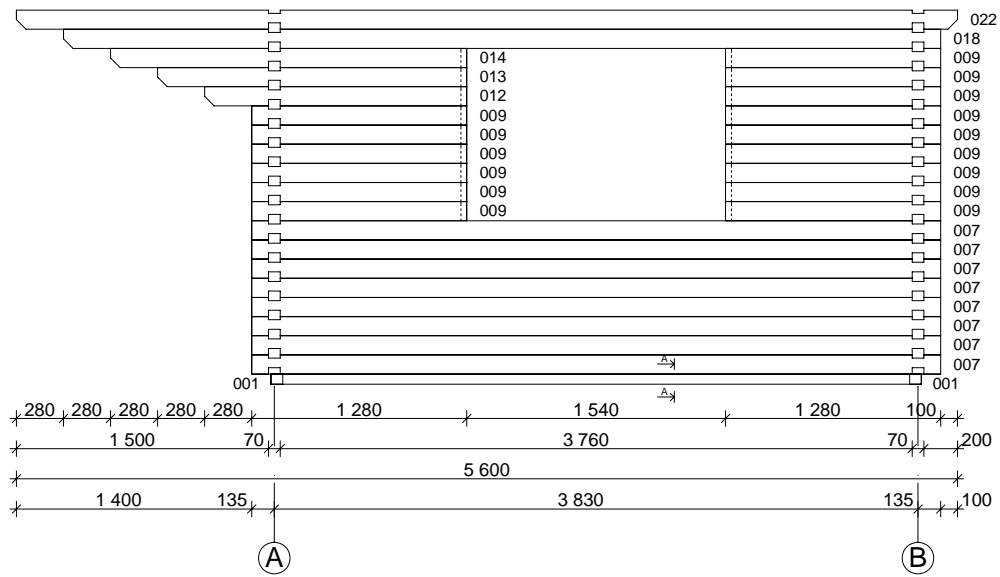

Wand D

