

# Techn. Daten Garage A

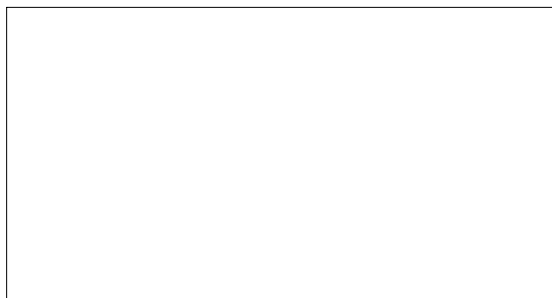

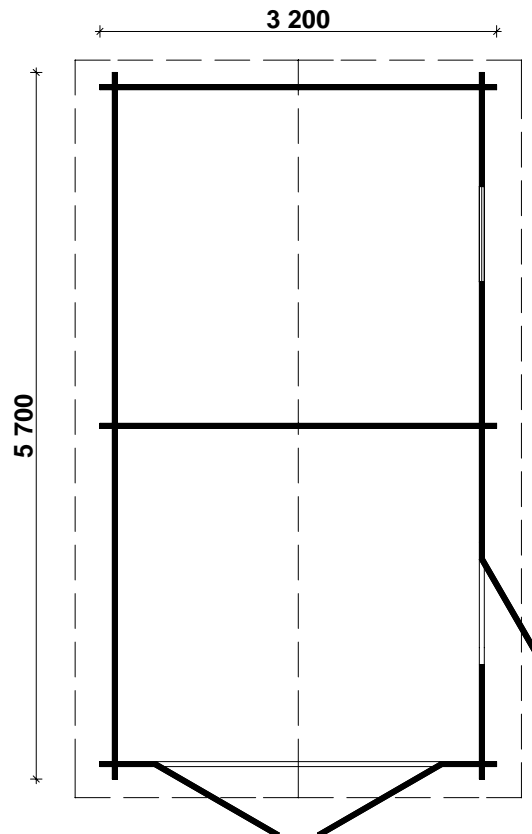

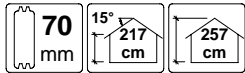

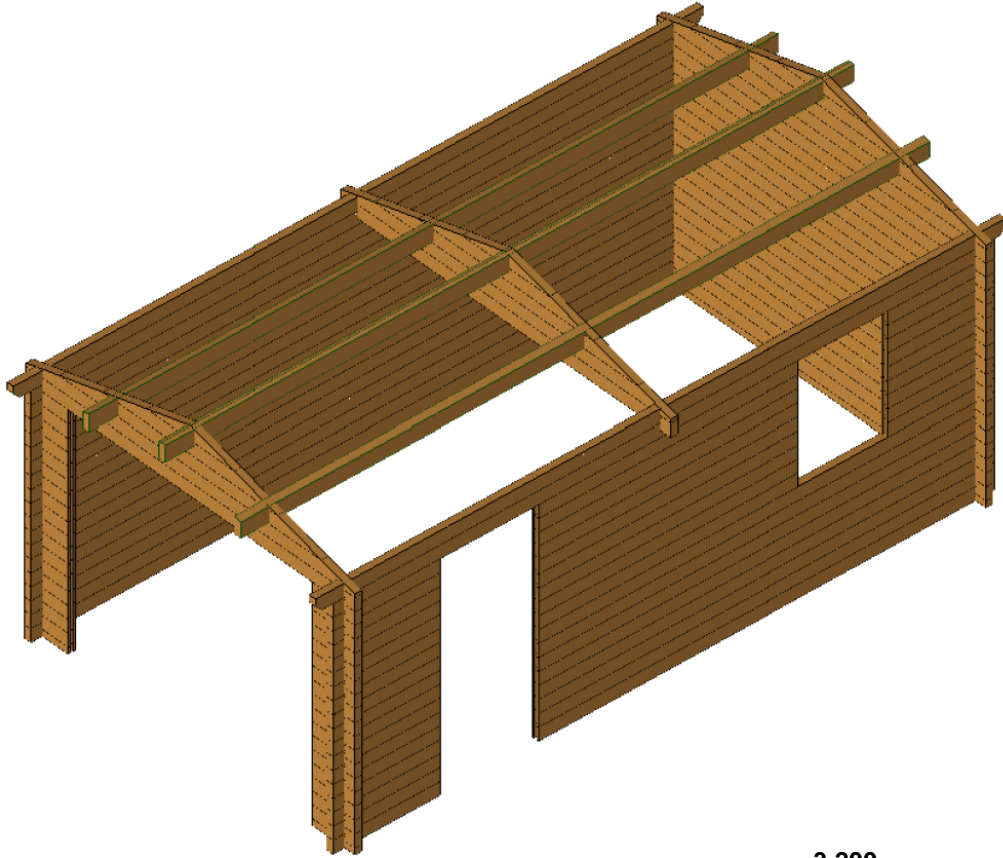





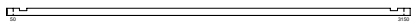
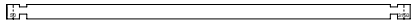
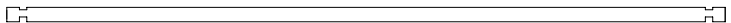
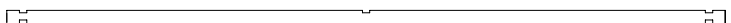

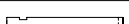
Bohlenaußenmaß (B x T): 320 x 570 cm

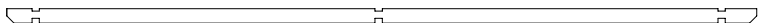
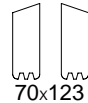
Wandaußenmaß: 300 x 550 cm · Bohlenstärke: 70 mm

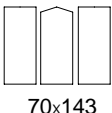
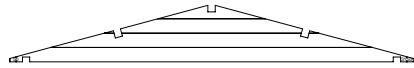

Achtung : Alle angegebenen Maße sind ca. - Maße !

# Garage A 70 - 320 x 570 cm

Nr	Beschreibung	Profil mm	Länge mm	Stück
1			410	2
2			3200	1
3			3200	20
4			5700	17
5			5700	2
6			3930	8
7			920	26
8			410	34
9			2240	9
10	Abgeschrägte Vordachbohle 	 70x123	5950	2(1+1)
11	Dachbalken 	 70x143	5950	3(2+1)
12	Giebel 	 70x114	3200	3
13	Einzeltür ca. 840 x 1900mm / 70 mm ISO			1
14	Doppeltür ca. 2370 x 1955mm / 70 mm			1
15	Einzelfenster ca. 765 x 990mm / 70 ISO			1
16	Dachpappe			--
17	Dachbretter	Vers. 1 > 	2000	136+2
		Vers. 2 > 	2000	110+2
181	Giebelblende 	18x110	2034	4
182	Giebelblende 	18x143	2034	4
19	Giebelabschlussbrett	18x90	2034	4
20	Traufenbrett	18x90	2975	4
21	Traufenleiste	28x28	2975	4
22	Raute 			2
23	Schrauben 4,0 x 40 ; 5,0 x 70			1 Beutel
24	Schrauben 4,0 x 50			1 Beutel
25	Dachpappnägel 3,0 x 15			--
26	Gewindestangen	∅ 10	2200	4
27	Mutter, Scheibe			8
28	Fundament	28x55	3000/2695	2/4
29	Schlaghölzer		300-400	

# Garage A 70 - 320 x 570 cm

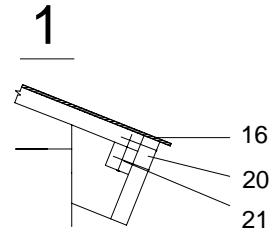
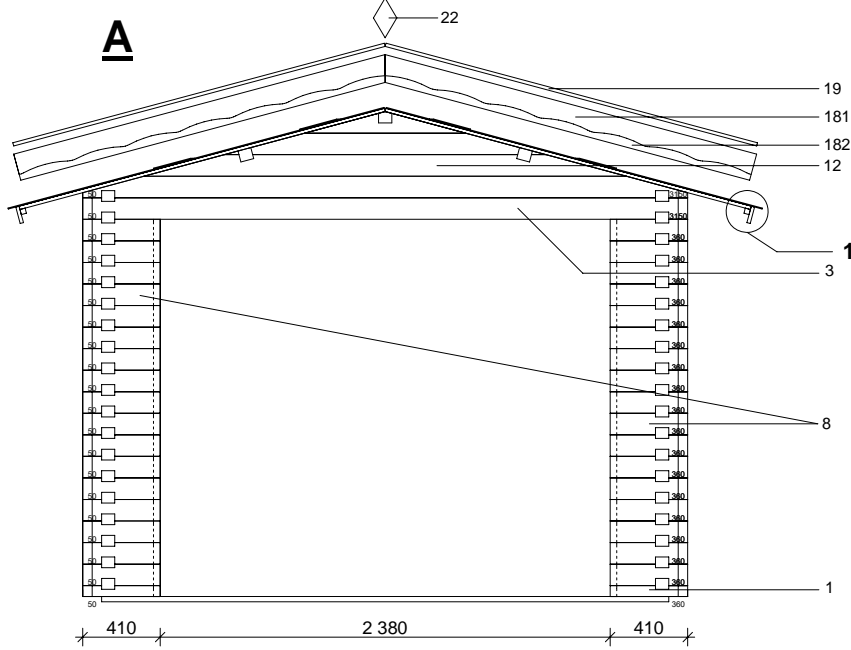

**A-A**

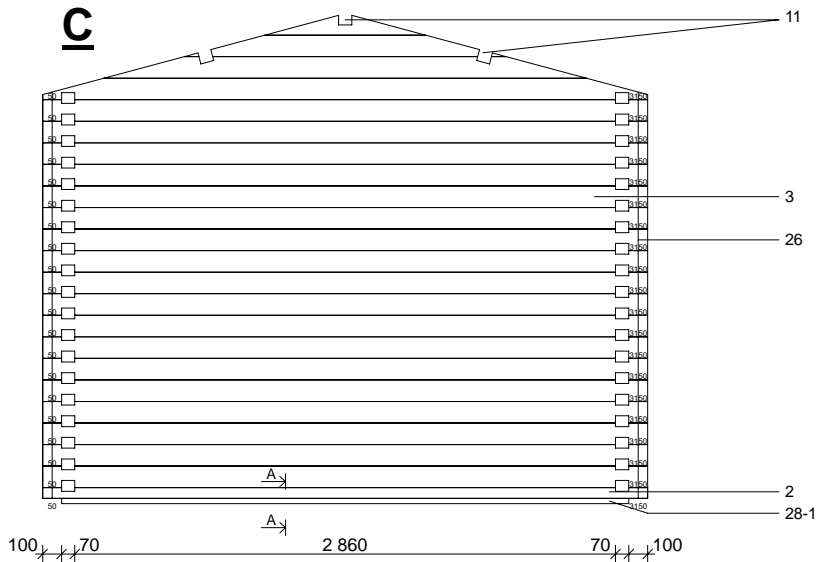

**B-B**

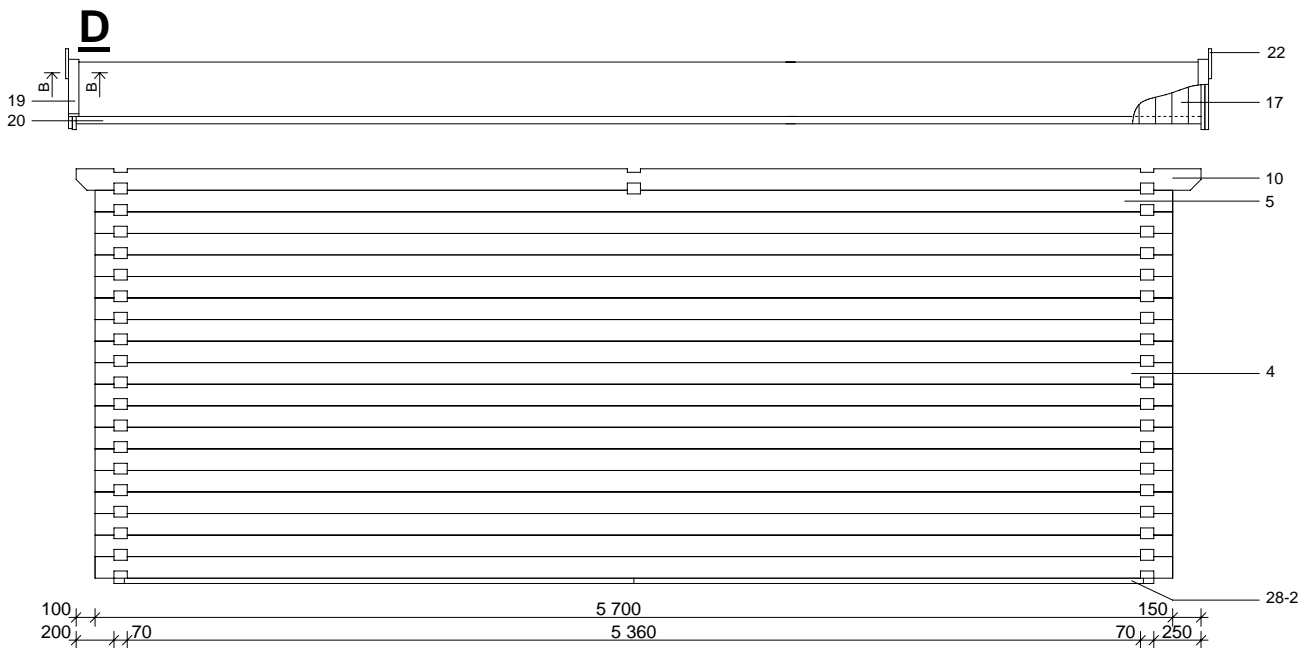
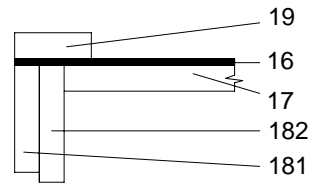

# Garage A 70 - 320 x 570 cm

**E**

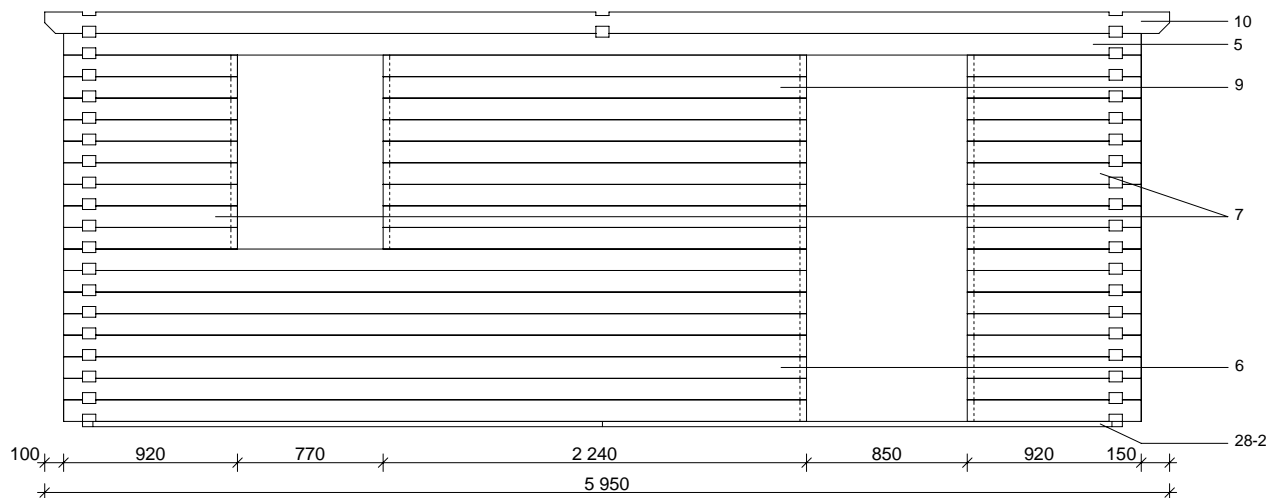

**B**

