

Flipp
Art. Nr. 199500
1/15

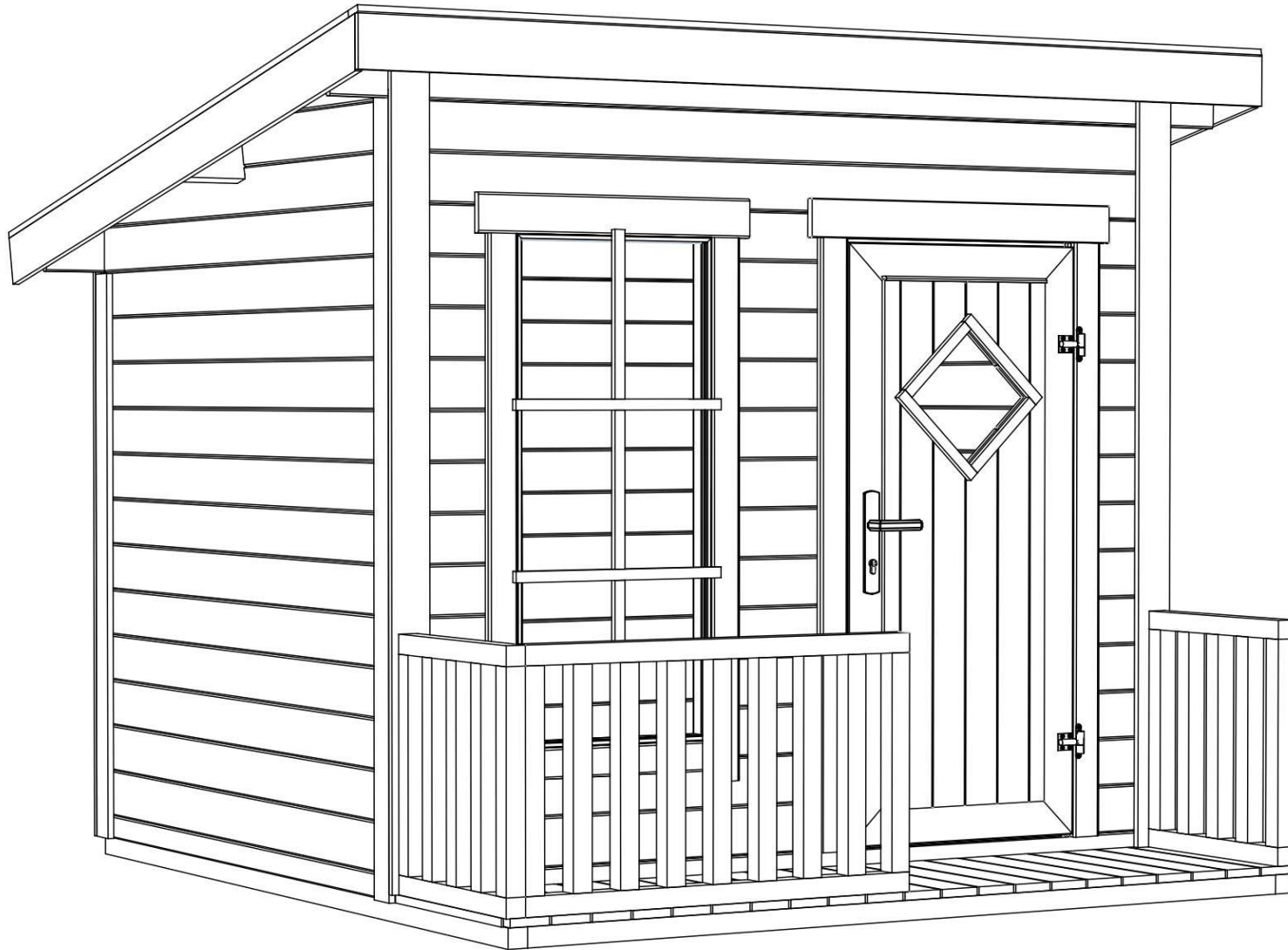

17.02.2022

Art. Nr. 199500
Groundplan - Grundplan - Plan de masse - Planimetria - Plattegrond
- Põhiplaan

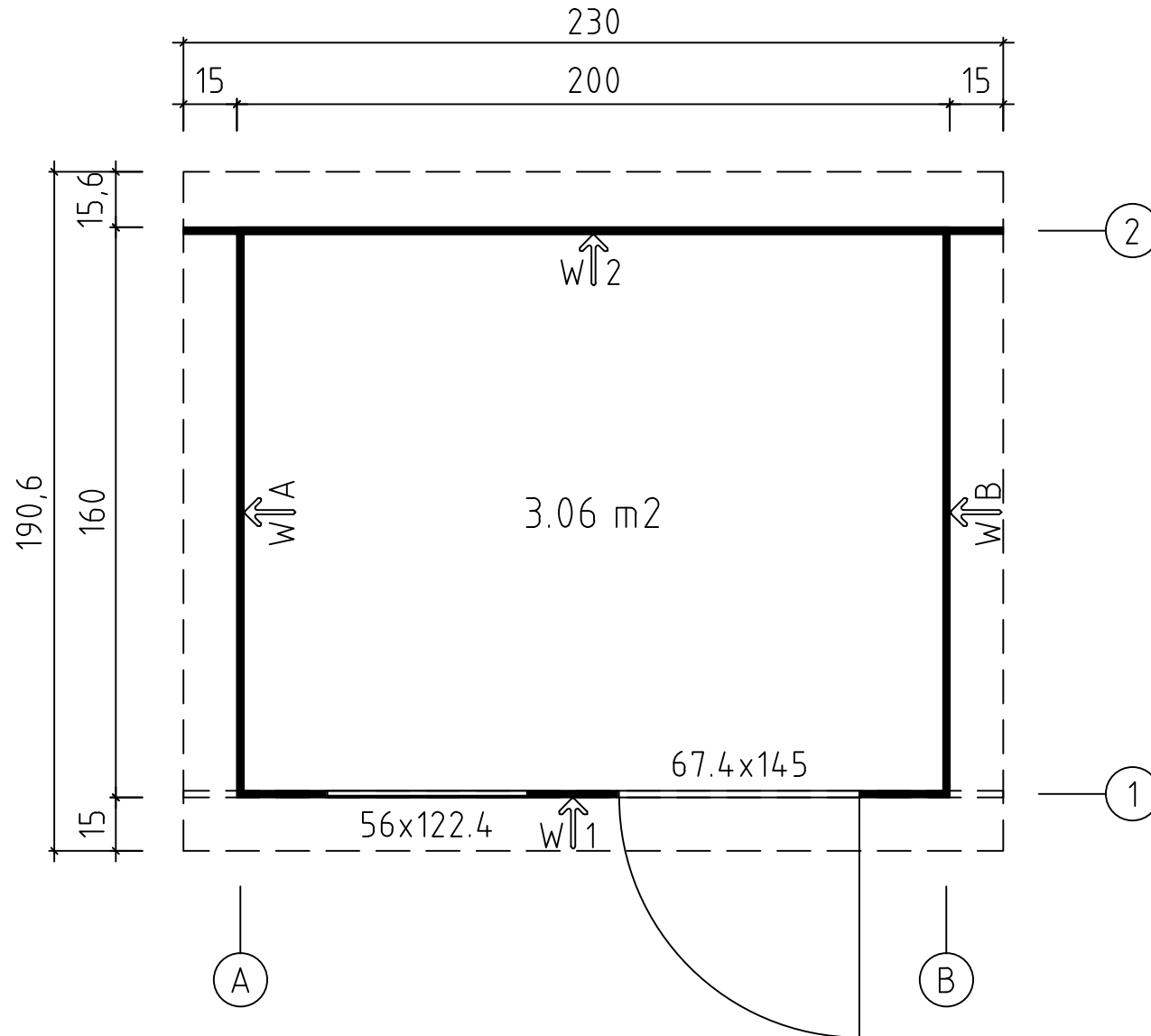

Art. Nr. 199500

Foundation - Fundament - Fondazione - Fundamenta - Fundering -
Immutatud alusraam

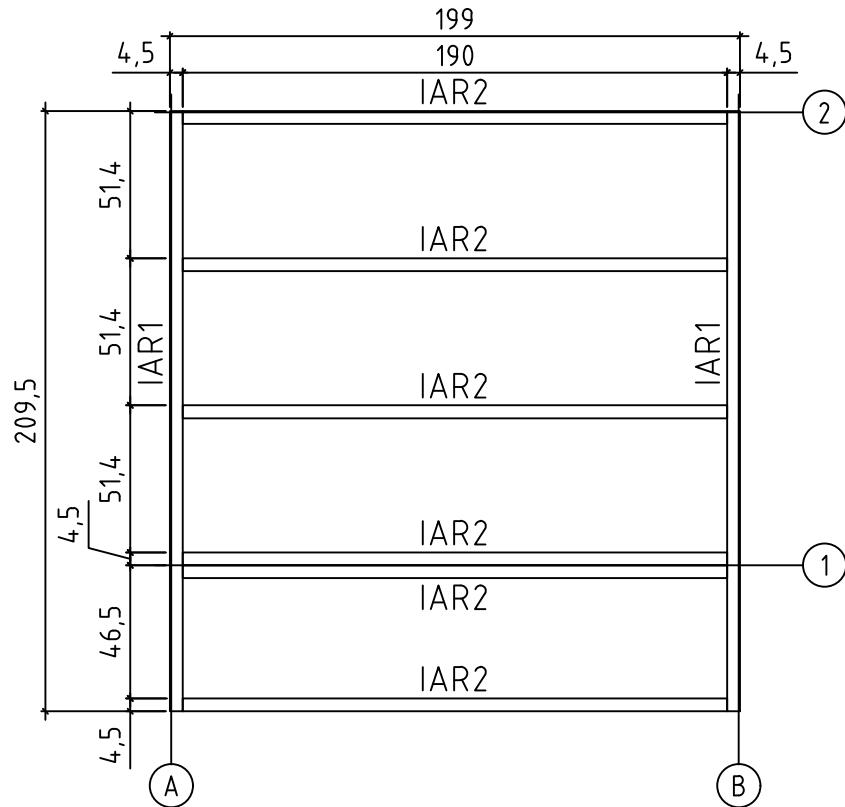

Floor boards - Fussbodenbretter - Plan pose plancher - Pavimento -
Vloerhout - Põrandalaudis

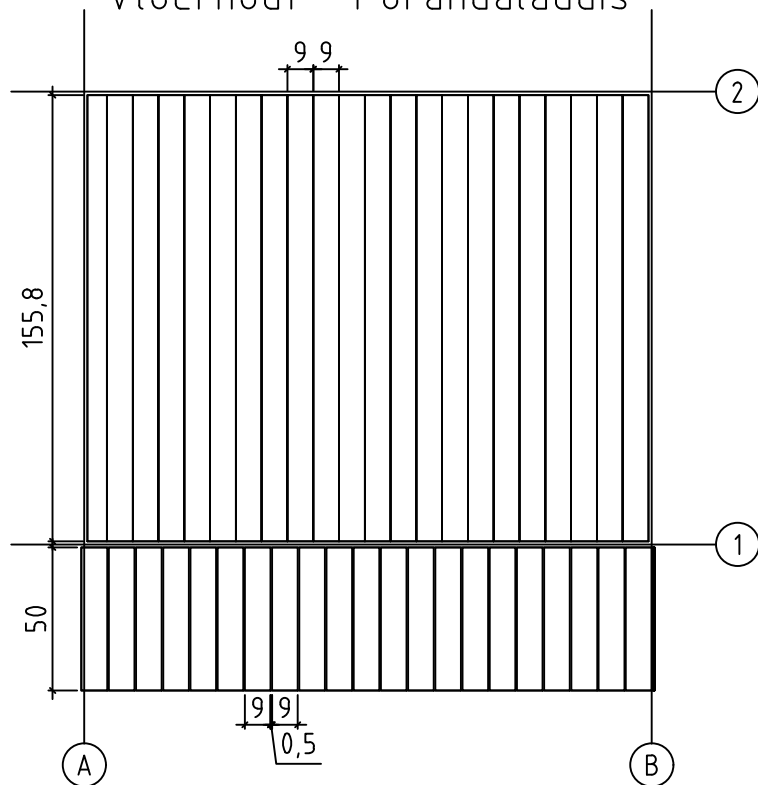





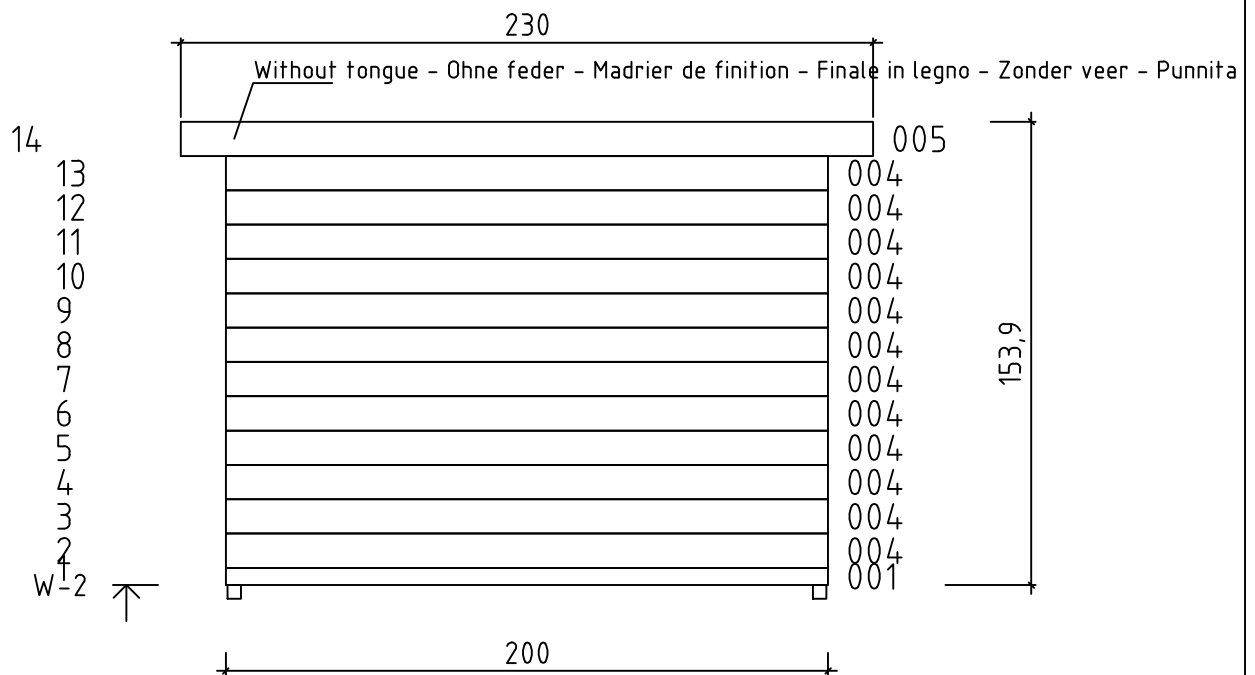
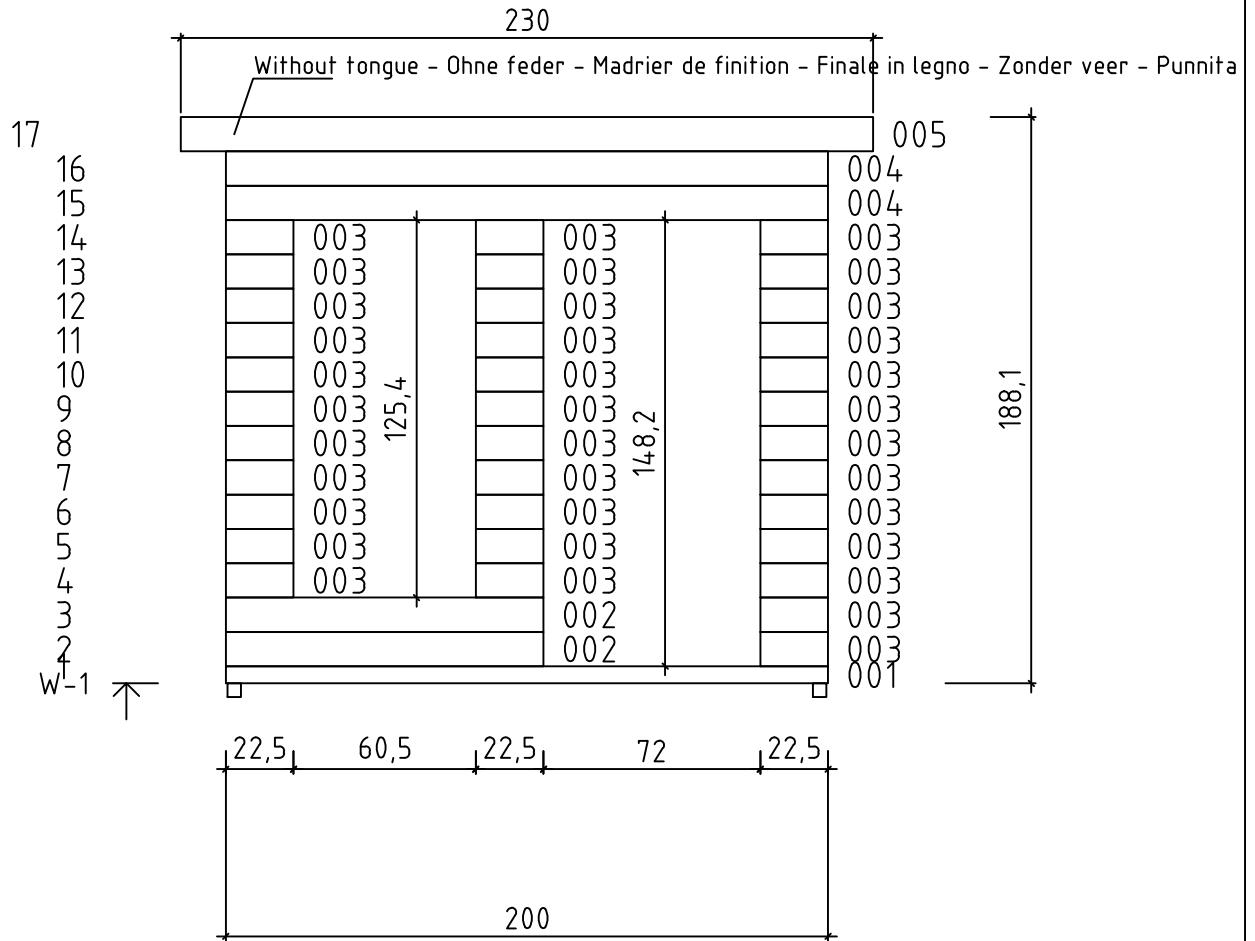



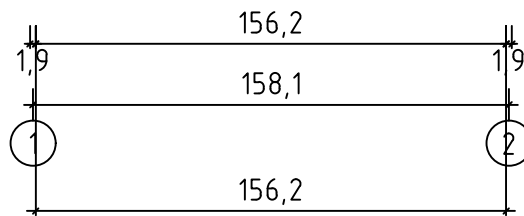
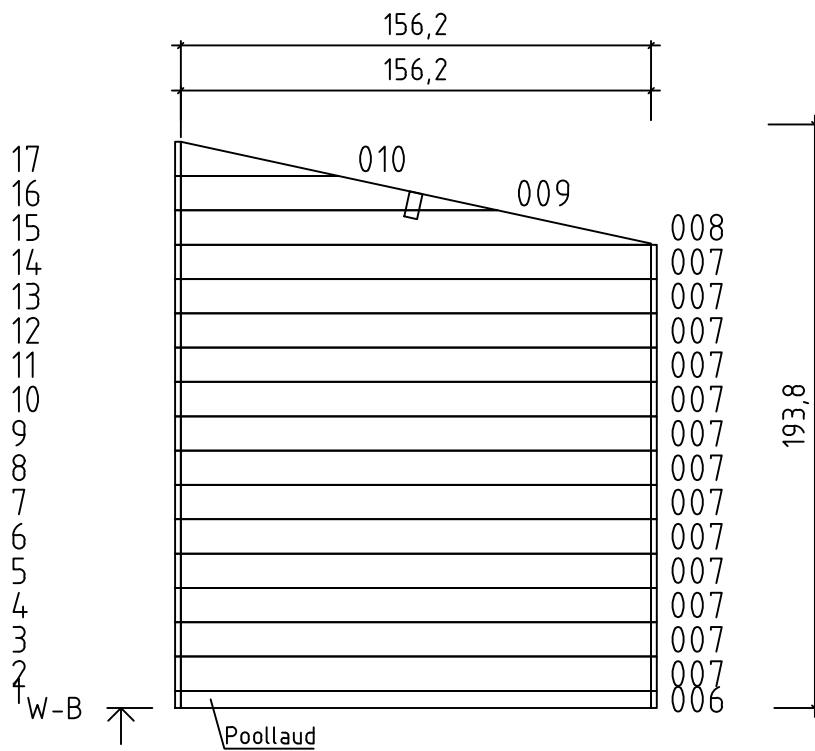
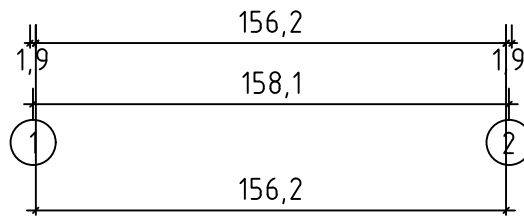
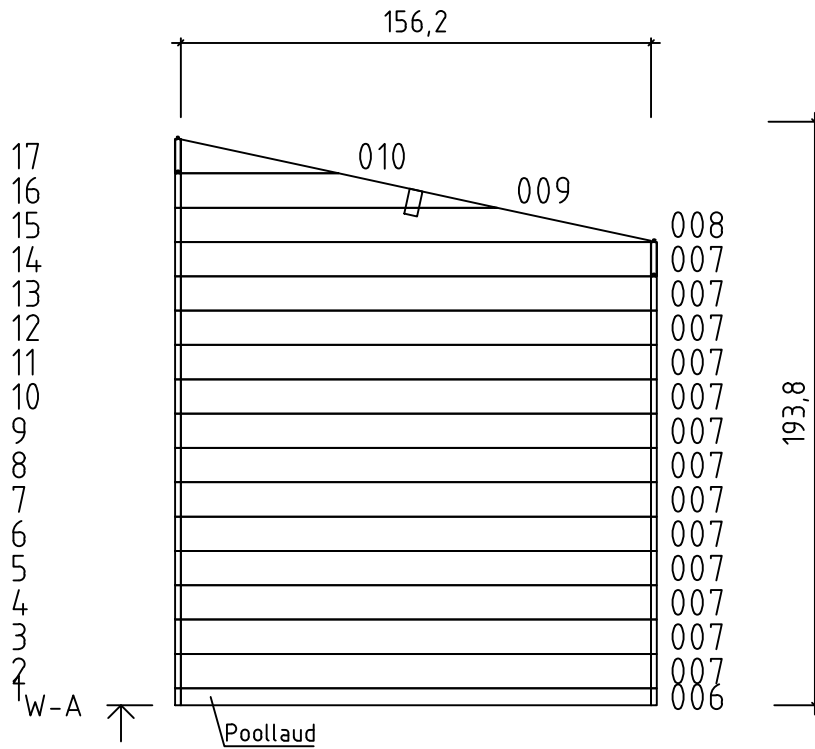

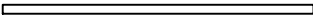



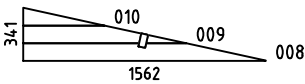
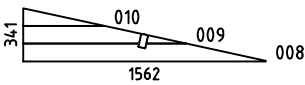

Terrace boards - Terrassenbretter - Plancher de terrasse -
Piattaforme terrazzo - Terrasvloer - Terrassilaudis

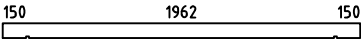





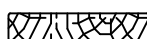
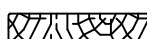
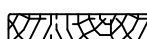
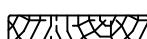









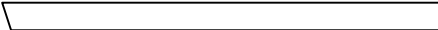
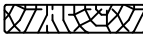
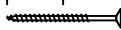

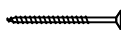
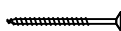
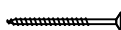
Art. Nr. 199500









Art. Nr. 199500

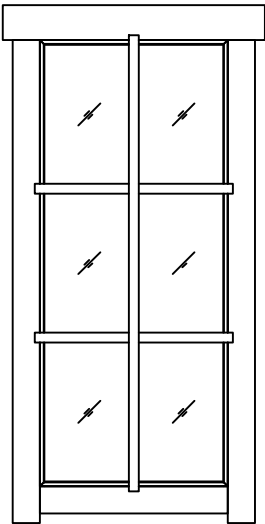
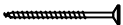

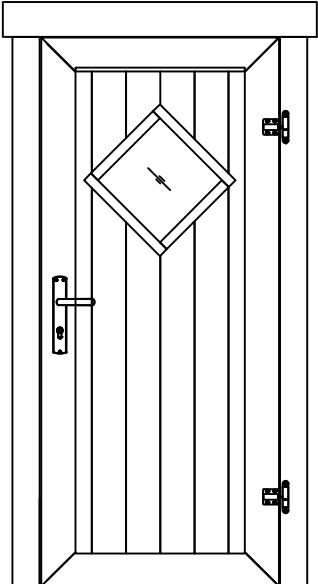
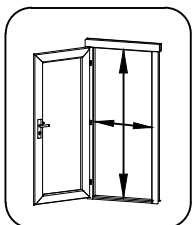
Pos	17.02.2022 Piece list - Stückliste - Liste des pièces - Elementi - Stuklijst - Tükitalabel Art. Nr. 199500 6/15	Q	P (mm)	L (mm)
001		2	19x57	2000
002		2	19x114	1055
003		35	19x114	225
004		14	19x114	2000
005		2	19x114	2300
006		2	19x57	1562
007		26	19x114	1562
WA-1		1		
WB-1		1		
IAR1	Foundation - Fundament - Fondation - Fondamenta - Fundering - Immutatud alusraam 	2	45x45	2095
IAR2	Foundation - Fundament - Fondation - Fondamenta - Fundering - Immutatud alusraam 	6	45x45	1900
A-PR1	Roof beam - Dachbalken - Panne de toit - Perlina del tetto - Gordingen / dakbalk - Pärilin 	1	44x95	2300
FB	Floor boards - Fussbodenbretter - Lame de plancher - Pavimento - Vloerhout - Põrandalaud 	22	90x15	1558
TB	Terrace boards - Terrassenbretter - Plancher de terrasse - Piattaforme terrazzo - Terrasvloer - Terrasilaud 	22	90x19	500
RB	Roof boards - Dachbretter - Voliges - Perlina per tetto - Dakhout - Katuselaud 	26	90x15	1950
FBL	Floor fillet - Fussbodenteiste - Corniere de finition du plancher - Finitura per pavimento (battisco pa) - Vloerafwerkljst - Põrandaliist 		18x18	8
DPL1	Roofing felt fillet - Dachpappenleiste - Baguette de fixation du feutre bitumeux - Asse per fissaggio guaina bituminosa - Afdekljst asfaltpapier - Katusepapiiist 	2	15x45	1970
DPL2	Roofing felt fillet - Dachpappenleiste - Baguette de fixation du feutre bitumeux - Asse per fissaggio guaina bituminosa - Afdekljst asfaltpapier - Katusepapiiist 	1	15x45	2330
CF1	Corner fillet - Deckleiste - Profils de finition angles a l'exterieur - Massello d'angolo - (hoek)lijst - Nurgaliist 	2	15x70	1425
CF2	Corner fillet - Deckleiste - Profils de finition angles a l'exterieur - Massello d'angolo - (hoek)lijst - Nurgaliist 	2	15x70	1767
CF3	Corner fillet - Deckleiste - Profils de finition angles a l'exterieur - Massello d'angolo - (hoek)lijst - Nurgaliist 	2	15x90	1535
CF4	Corner fillet - Deckleiste - Profils de finition angles a l'exterieur - Massello d'angolo - (hoek)lijst - Nurgaliist 	2	15x90	1862
CS1	Corner stud - Eckpfosten - Poteaux d'angle pour fixation des madriers - Perno angolare - Hoek staander (kolom) - Nurgapost 	2	44x44	1510

Pos	17.02.2022 Piece list - Stückliste - Liste des pièces - Elementi - Stuklijst - Tükítabel Art. Nr. 199500 7/15	Q	P (mm)	L (mm)
CS2	Corner stud - Eckpfosten - Poteaux d'angle pour fixation des madriers - Perno angolare - Hoek staander (kolom) - Nurgapost 	2	44x44	1850
RS1	Railing strip - Begrenzungsleiste - Rembarde - Sbarra - Afscheidingslijst - Piirdelaud 	23	44x44	485
RS2	Railing strip - Begrenzungsleiste - Rembarde - Sbarra - Afscheidingslijst - Piirdelaud 	2	44x44	926
FF1	Fixing fillet - Fixierungsleiste - Profil de fixation - Massello di fissaggio - Bevestiging lijstwerk - Tenderliist 	2	18x18	1204
FF2	Fixing fillet - Fixierungsleiste - Profil de fixation - Massello di fissaggio - Bevestiging lijstwerk - Tenderliist 	2	18x18	1432
DRV-1	Roof edge reinforcement - Dachrandverstärkung - Corniere de renfort de bord de toit - Rinforzo x tetto - Dakrand versterking - Räästatugevdus 	1	15x45	2300
GM1	Gable moulding - Giebelleiste - Planche de rive - Finitura per frontale e retro del tetto - Gevellijst - Viilulaud 	2	15x120	2000
GM2	Gable moulding - Giebelleiste - Planche de rive - Finitura per frontale e retro del tetto - Gevellijst - Viilulaud 	1	15x120	2330
HS8	Screw for fixing fillet of door and window - Schrauben für fixierungsleiste - Vis pour profil vertical de fixation pour ouvertures des fenetres et portes - Viti per massello di fissaggio - Schroeven voor bevestiging van deur en raam lijsten - Krugi tenderliistudele 	96	3.5x35	
HS8	Screw for corner fillet - Schraube zur befestigung deckleiste - Vis pour profils de finition angles a l'exterieur - Viti per massellino d'angolo - Schroef voor afdekljst (hoek) - Krugi nurgaliistudele 	60	3.5x35	
HS9	Screw for wall details - Schraube für wand details - Vis pour mur details - Viti per elementi della porta - Schroef voor wand details - Krugi seinte montaažiks 	248	3.5x50	
HS9	Screw for gable moulding - Schrauben für giebelleiste - Vis pour fixation planche de rive - Vite per fissare finiture davanti e dietro del tetto - Schroef voor gevellijst - Krugi viilulauale 	22	3.5x50	
HS4	Screw for fascia boards - Schrauben für traufbretter - Vis pour fixation bandeau de toit - Viti x striscia del tetto - Schroef voor gevellijst - Krugi räästalauale 	6	3x30	
HS12	Screw for metal corner - Holzschraube für metallwinkel - Vis de fixation des cornieres en métal - Viti per fissare suadretta di metallo di giunzione - Schroef voor metalen hoek - Krugi nurgikule 	24	4x40	
HS18	Screw for roof beams - Schrauben für dachbalken - Vis pour fixation pannes de toit - Viti per perline del tetto - Schroef voor gordingen / dakbalken - Krugi pärlinitele 	2	5x120	
HS18	Screw for gable - Schrauben für giebel - Vis pour fixation des pignons - Viti per timpano - Schroef voor gevelpunt - Krugi viilude kinnitamiseks 	4	5x120	
HS16	Screw for foundation - Schrauben zur befestigung fundament - Vis de fixations des poutrelles de fondations - Viti x fondamenta - Schroef voor fundering - Krugi alusraamile 	12	5x90	
HS16	Screw for post - Schrauben für pfosten - Vis de fixation des poteaux - Viti per inviare - Schroef voor stijlen - Krugi postile 	88	5x90	
HS16	Screw for foundation - Schrauben zur befestigung fundament - Vis de fixations des poutrelles de fondations - Viti x fondamenta - Schroef voor fundering - Krugi alusraamile 	2	5x90	
NF2	Zn nail for floor fillet - Zn nagel für fussbodenleiste - Pointe pour corniere de finition du plancher - Chiodi x fissaggio pavimento - Spijker(nagel) voor vloer afdekljst - Nael põrandaliistule 	18	1.4x40	
SH19	Hammer block - Schlagholz - Calle de frappe - Blocco di legno da usare come cuscinetto quando si usa il martello - Slagklos - Löögiklots 	1		
NF3	Zn nail for terrace - Zn nagel für terrassenbretter - Pointe pour plancher de terrasse - Chiodo zincato per terrazza - Spijker(nagel) voor terrasvloer - Nael terrasilauale 	92	2.1x50	
NF4	Zn nail for roof - Zn nagel für dachbretter - Pointe pour fixation voliges de toit - Chiodi x perline tetto - Spijker(nagel) voor dakhout - Nael katuselauale 	85	2x50	

Pos	Piece list - Stückliste - Liste des pièces - Elementi - Stuklijst - Tükitalabel 17.03.2022 554x1218 AK.1.106.XM0.l XGC_XGA 1/1	Q	P (mm)	L (mm)
<p data-bbox="261 152 1294 181">Glass size - Glasgröße - Taille de la vitre - Misura del vetro - Glas afmeting - Klaasi mõõt: 480x1144 mm</p> 				
HS1	Screw for georgian bars - Schraube für sprossen - Vis pour croisillons - Viti per unire la griglia georgiana della finestra - Schroeven voor raamverdeling - Kruvi akna petfeliistule	 6	2.5x20	

Pos	16.02.2022	Piece list - Stückliste - Liste des pièces - Elementi - Stuklijst - Tükitabel 674x1450 UK.2.020.SVP MMX19 SGA+28	1/2	Q	P (mm)	L (mm)
		  <p>598x1394 mm</p>				
1	Upper door jamb - Türrahmen oben - Cadre de porte supérieur - Telaio superiore della porta - Bovendorpel - Ukse ülemine leng		1	57x100	618	
2	Left door jamb - Türrahmen links - Cadre de porte gauche - Telaio montante sinistro della porta - Linkerstijl deurframe - Ukse vasak leng		1	57x80	1436	
3	Right door jamb - Türrahmen rechts - Cadre de porte droit - Telaio montante destro della porta - Rechterstijl deurframe - Ukse parem leng		1	57x80	1436	
4	Doorstep - Swelle - Barre de seuil - Soglia della porta - Deurdorpel - Lävepak		1	15x21	674	
5	Glass - Glas - Vitre - Vetro - Glas - Klaasi			246x246	15	
6	Fillet - Leiste - Lattes - Massello - Lijst - Liist		2	15x25	276	
7	Fillet - Leiste - Lattes - Massello - Lijst - Liist		2	15x25	226	

Art. Nr. 199500

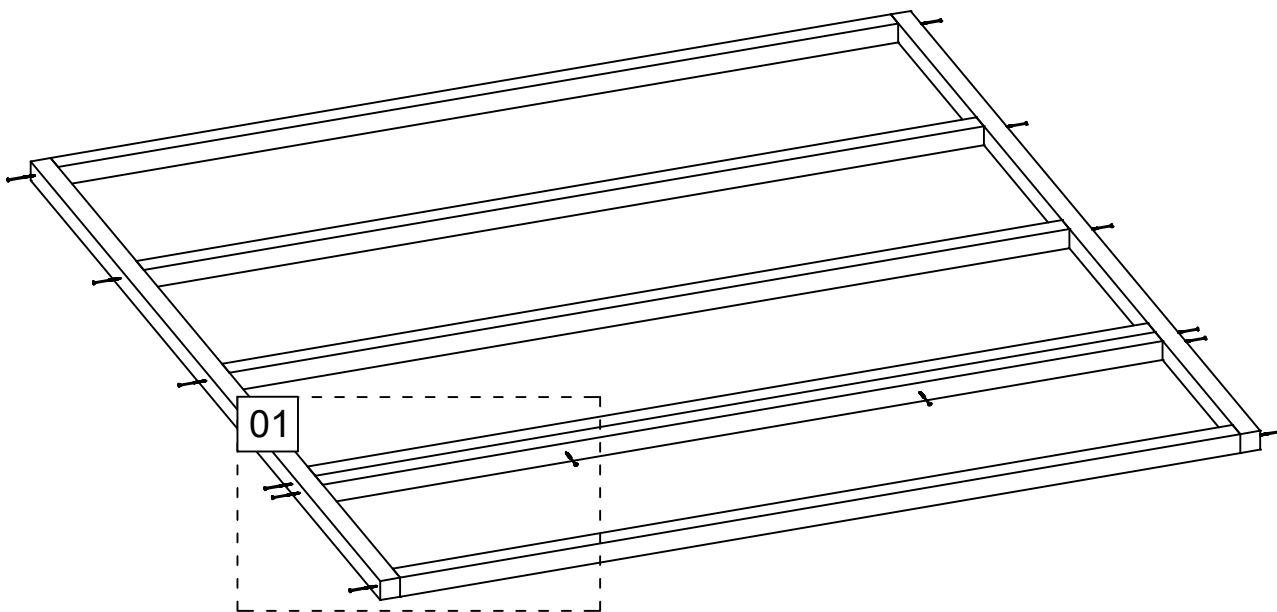

01

IAR2

HS16

IAR1

HS16

02

001

006

TB

HS9

NF3

03

001

006

FB

NF4

17.02.2022

9/15

Art. Nr. 199500

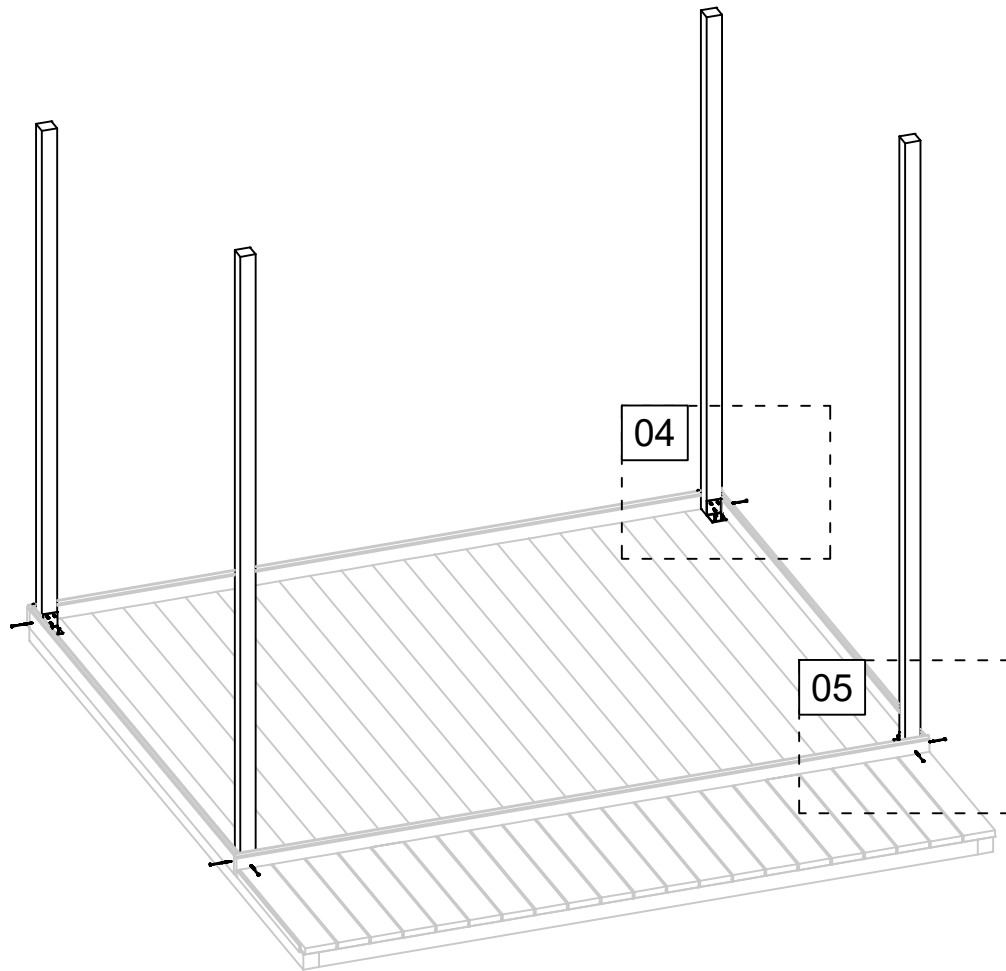

17.02.2022

04

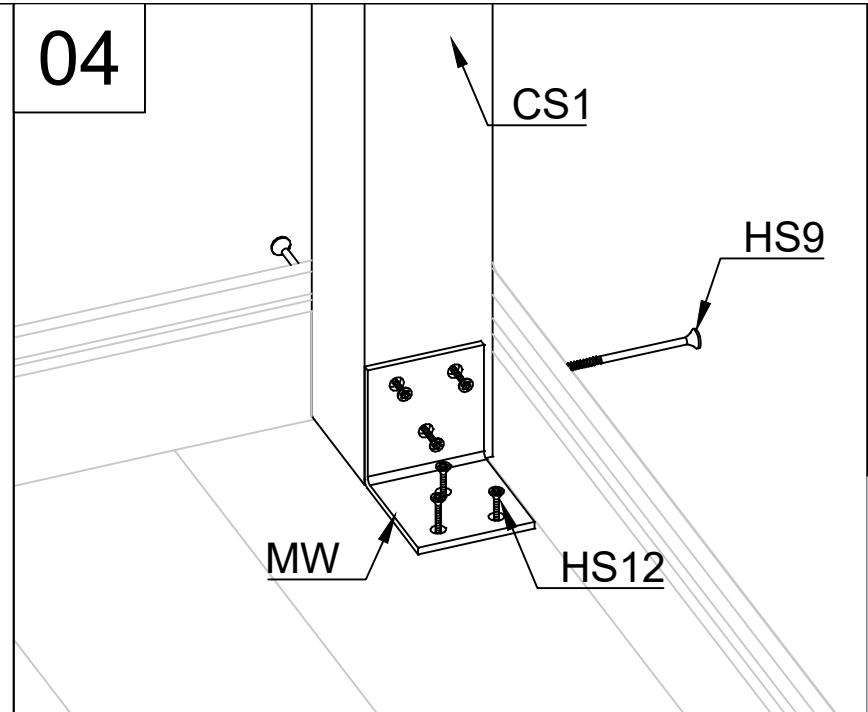

05

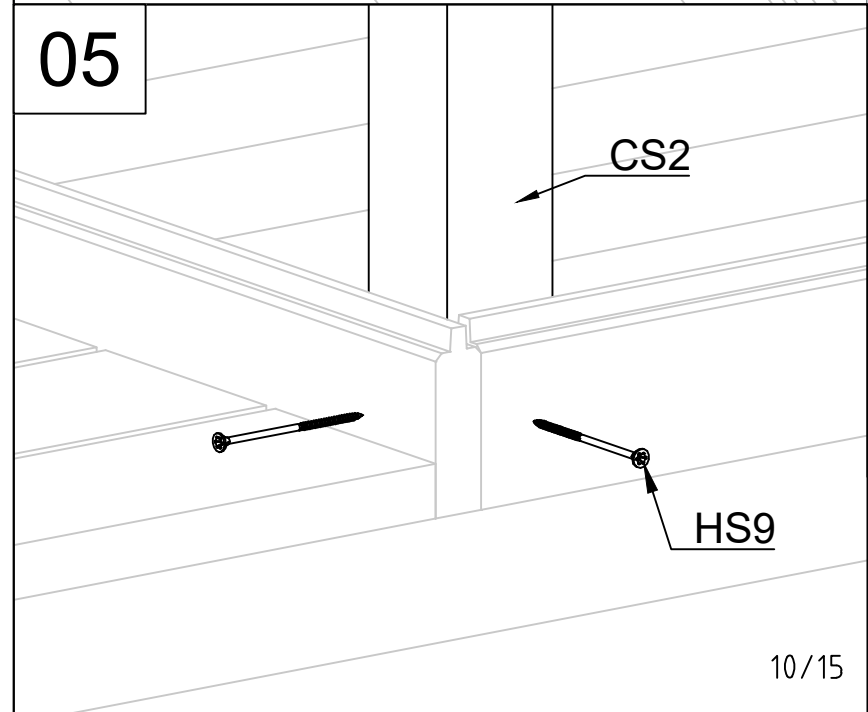

10/15

Art. Nr. 199500

08

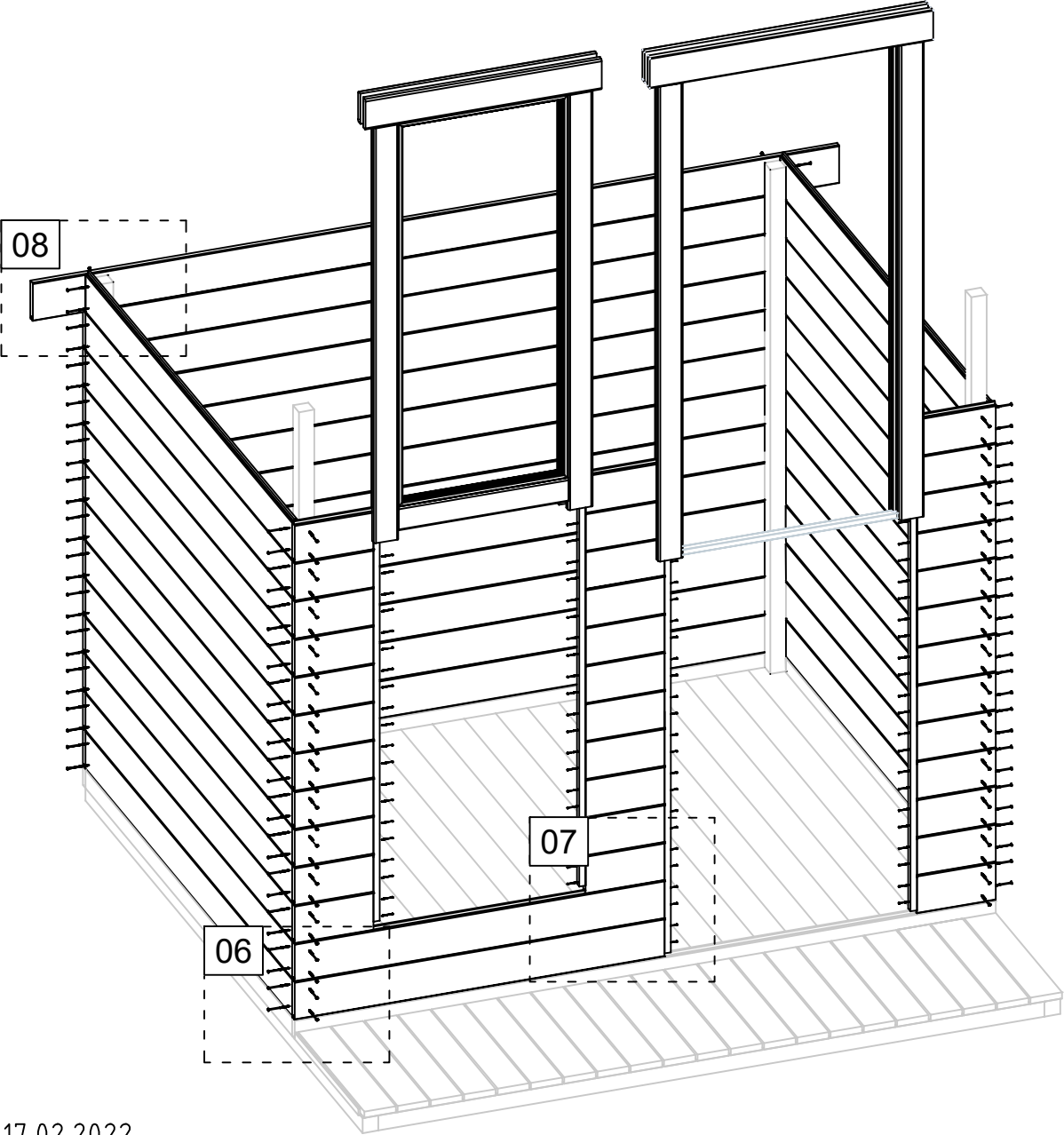

06

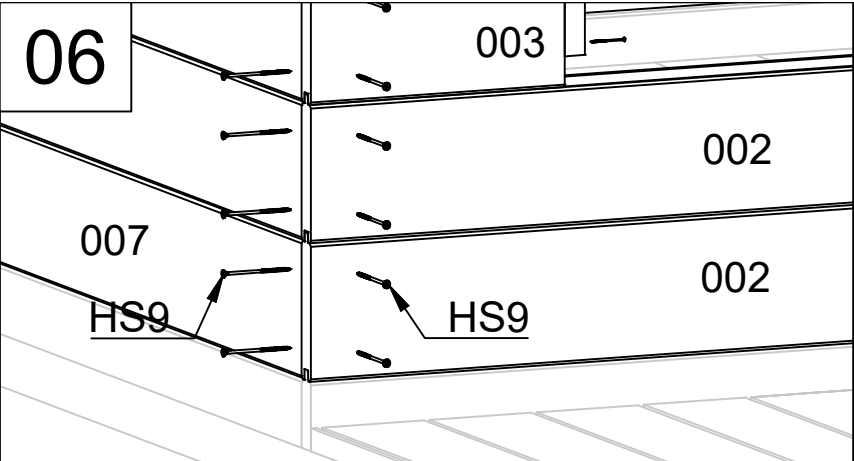

07

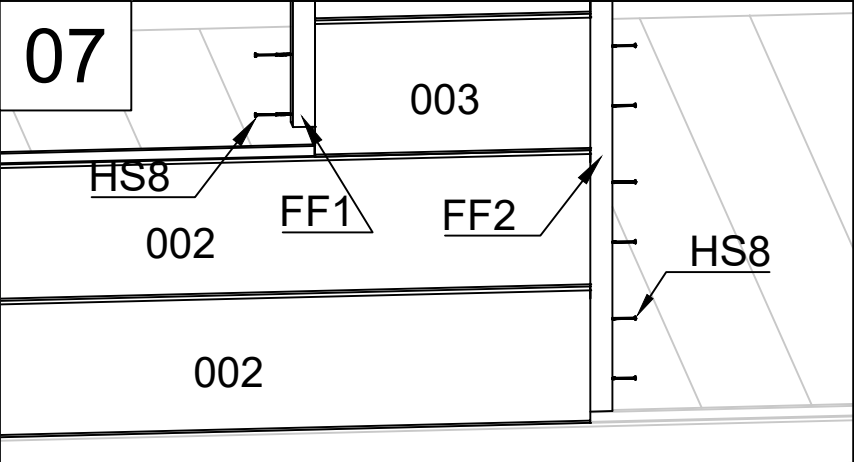

08

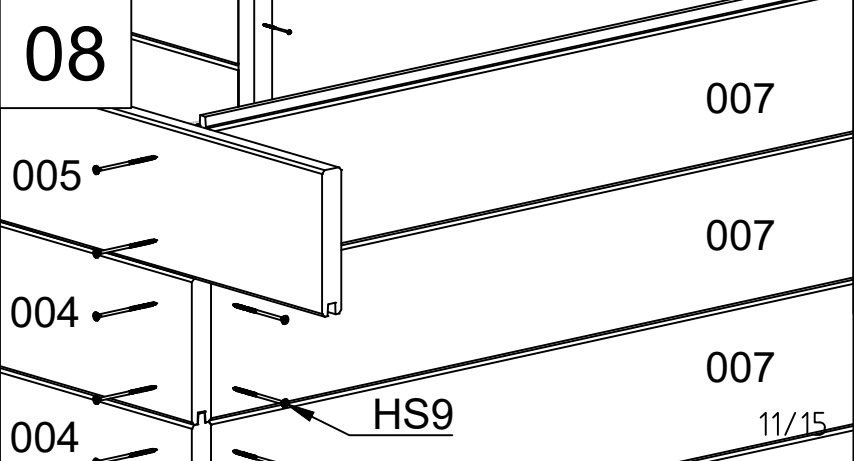

17.02.2022

11/15

Art. Nr. 199500

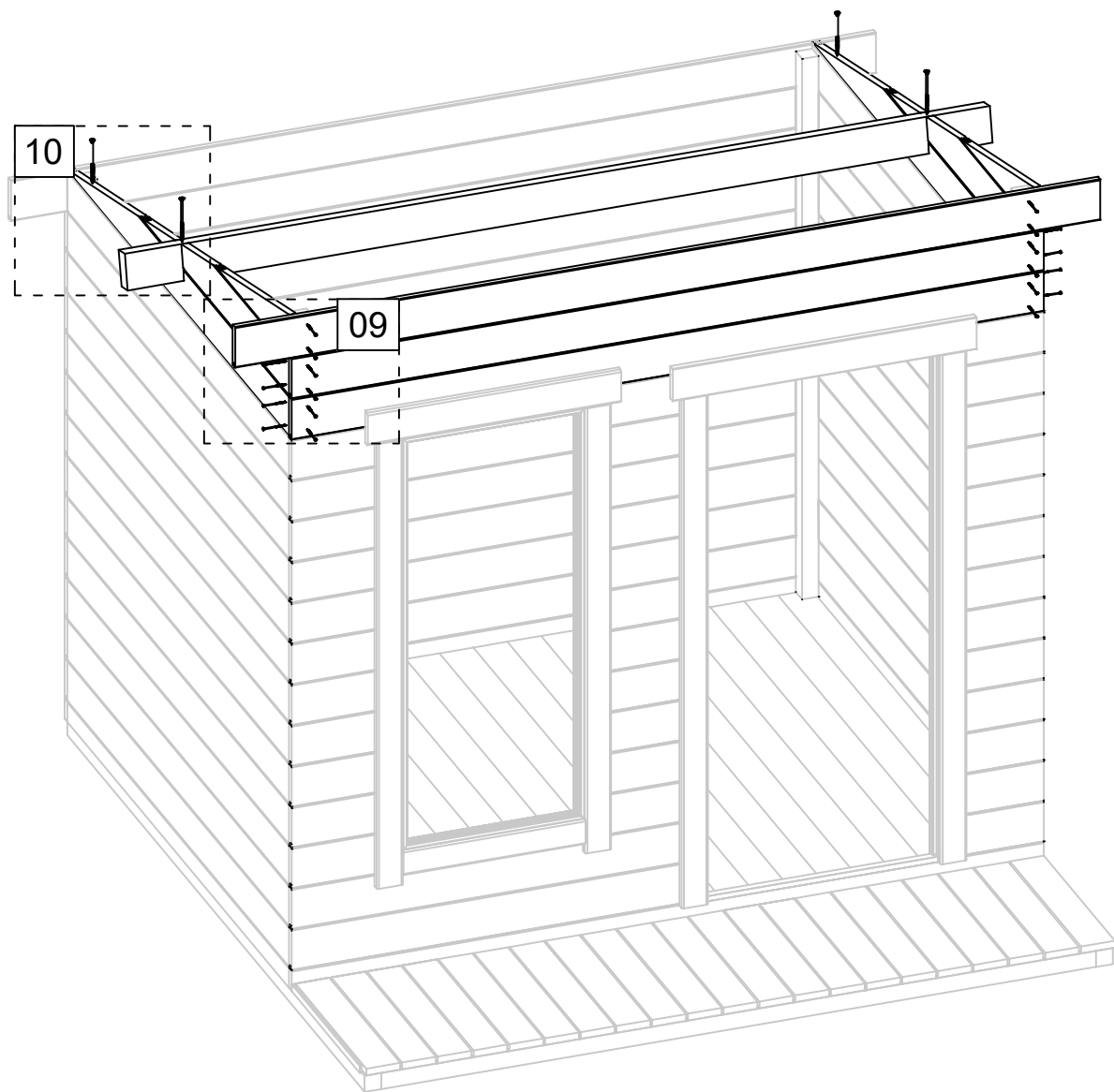

09

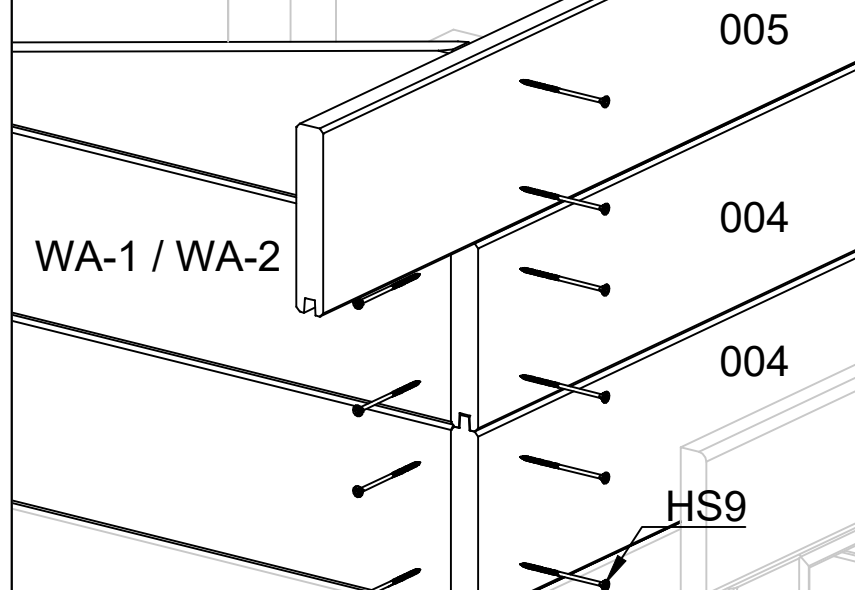

10

HS18

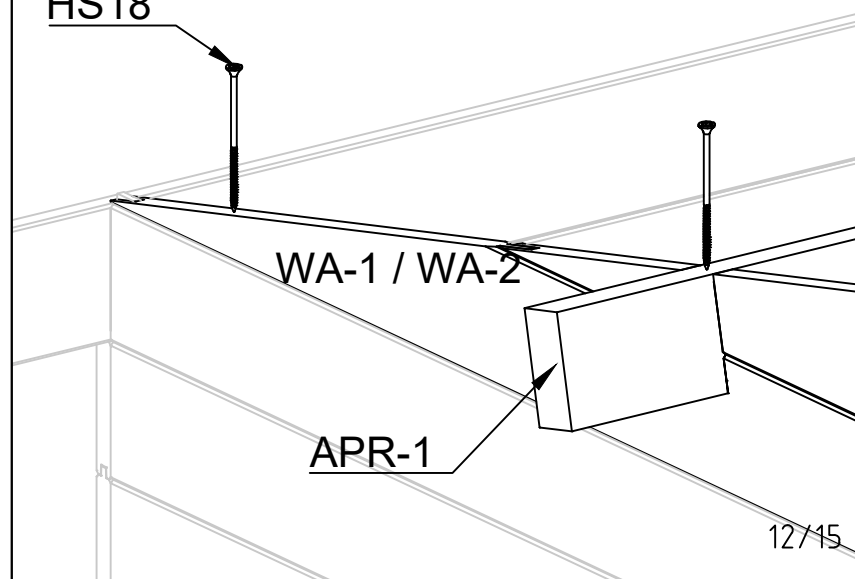

Art. Nr. 199500

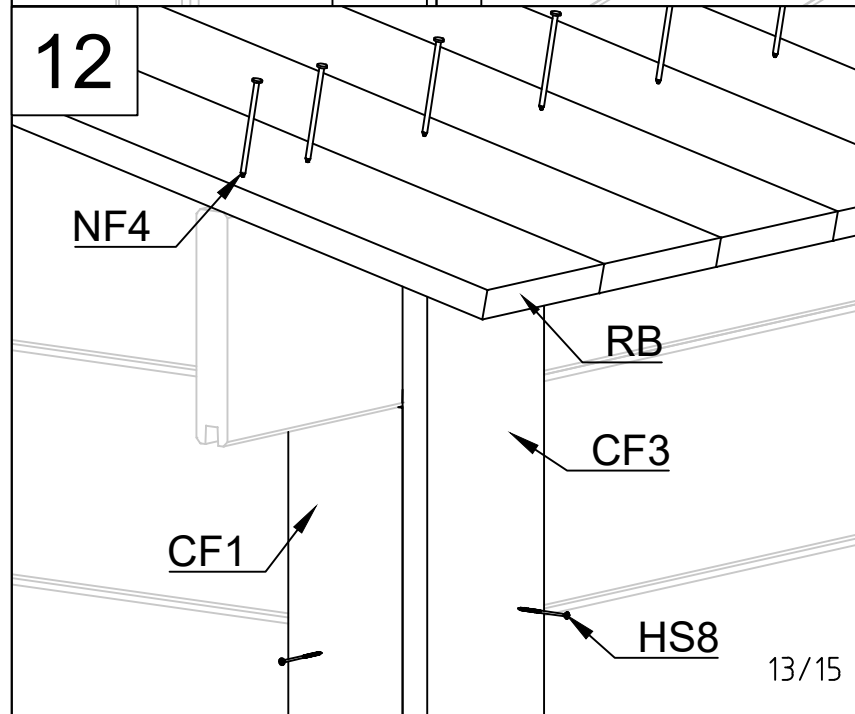
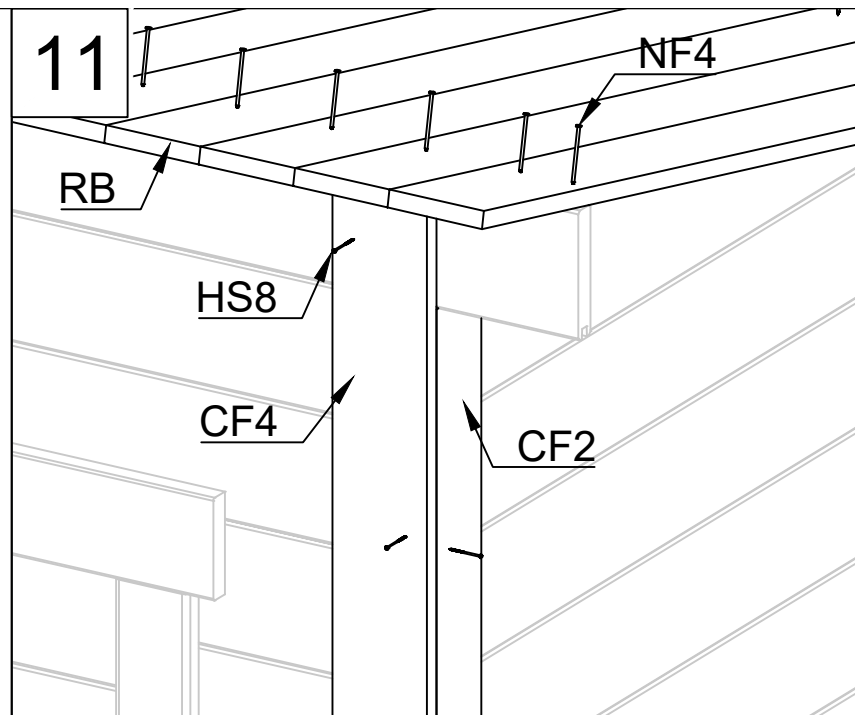
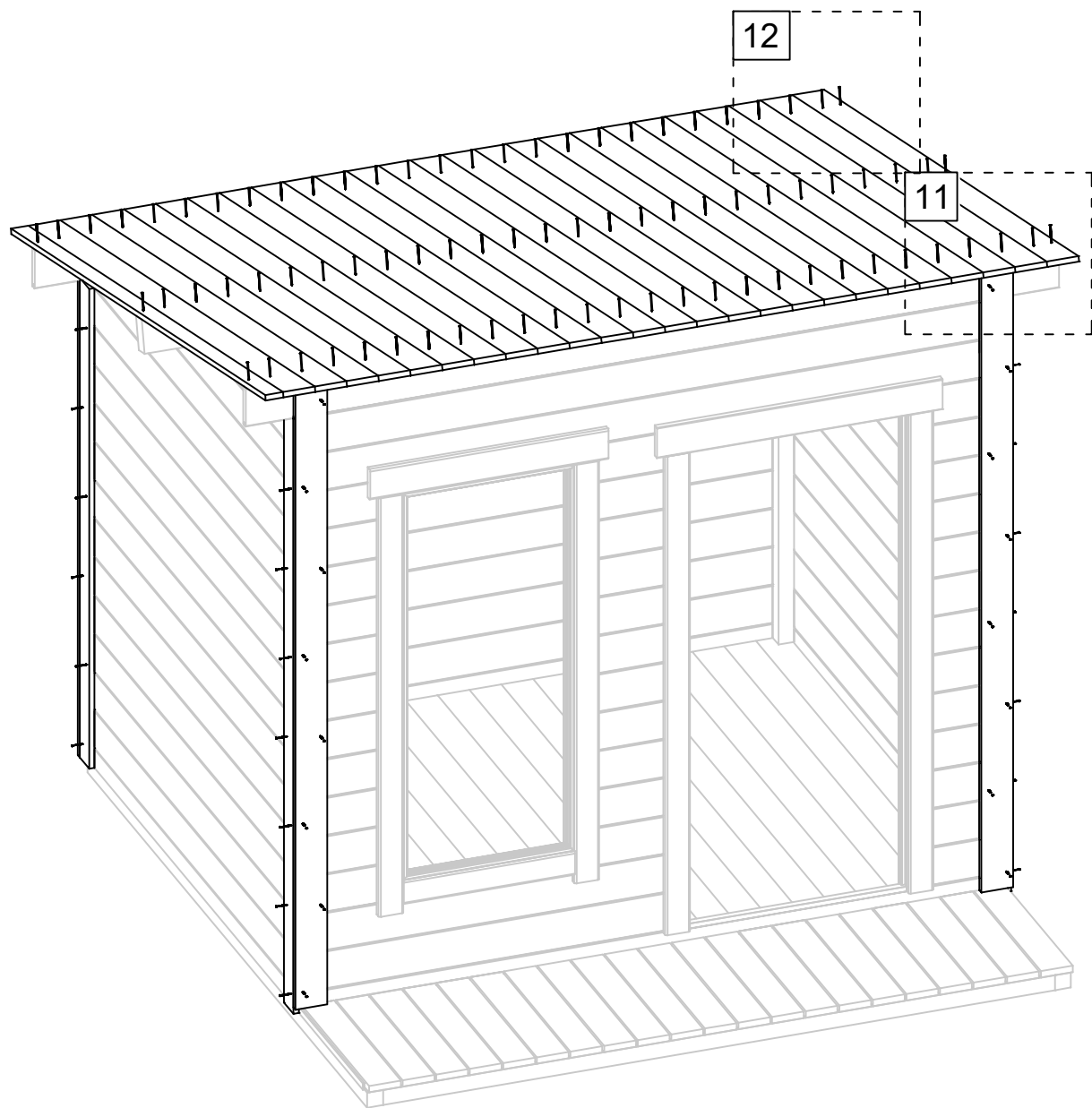

Art. Nr. 199500

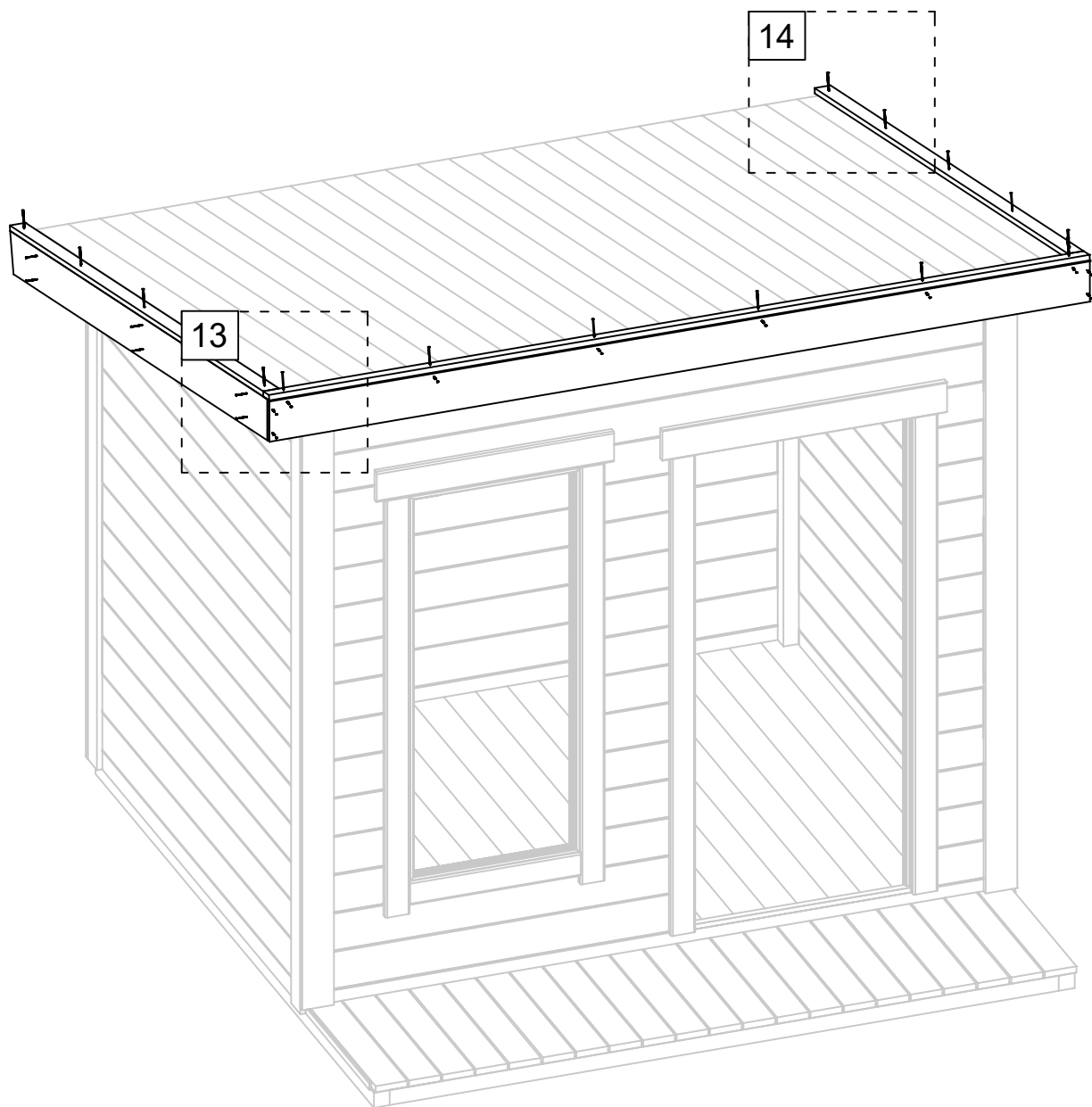

13

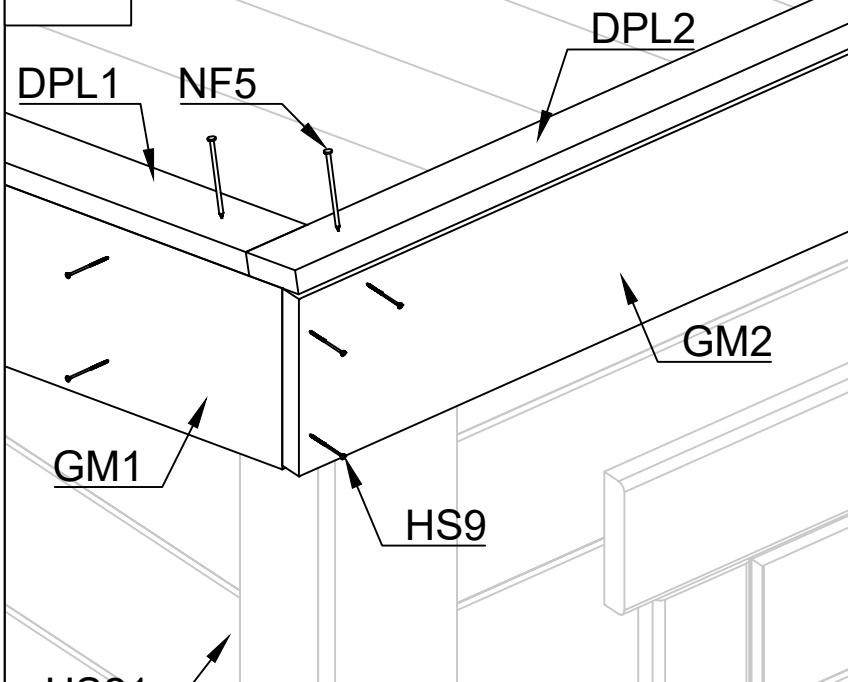

14

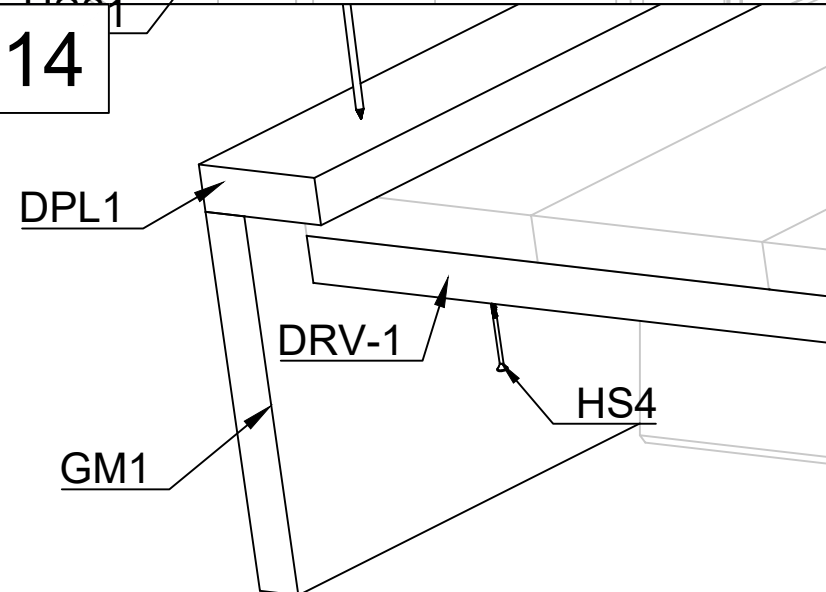

Art. Nr. 199500

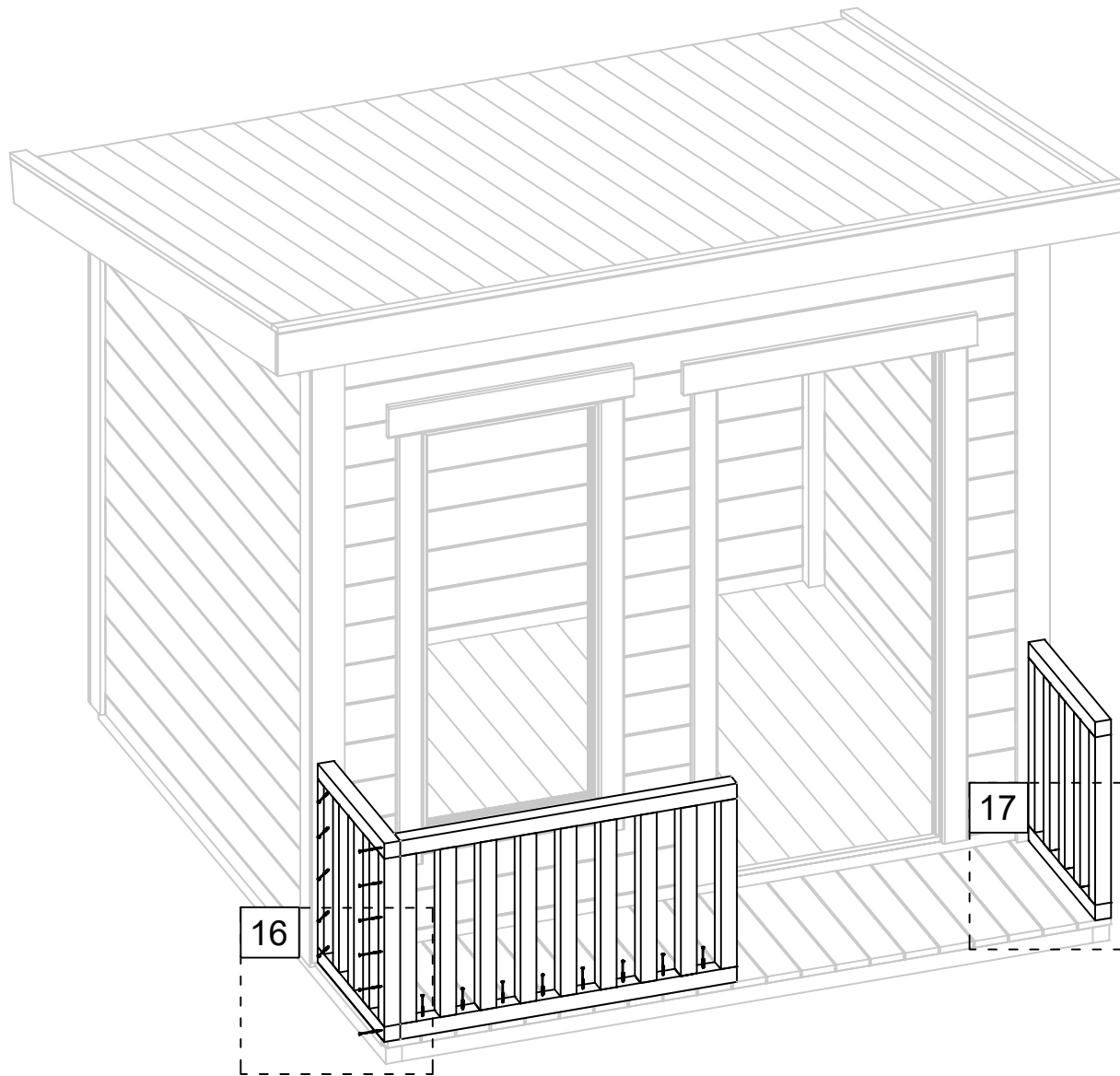

15

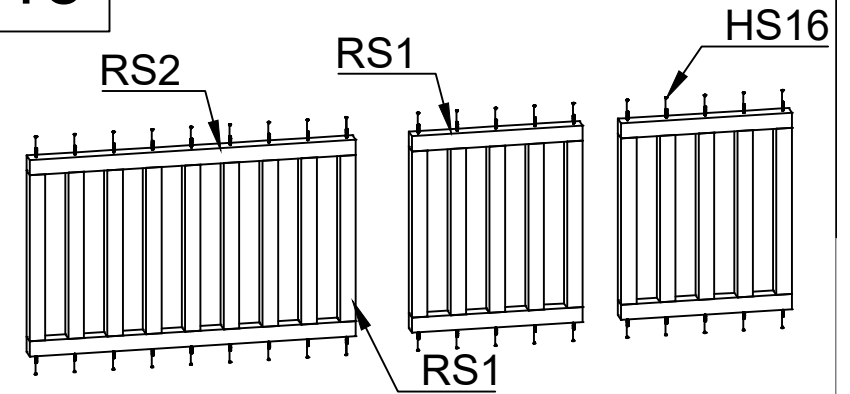

16

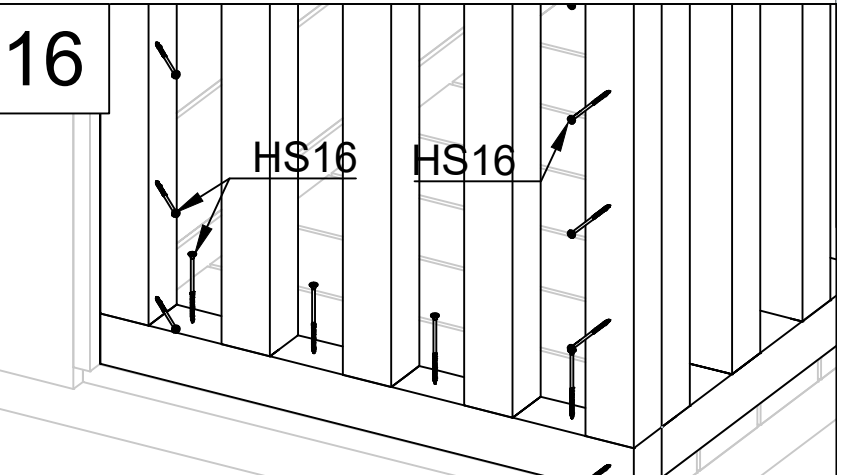

17

