

EUFRAFAT 70
Art.No. 701902

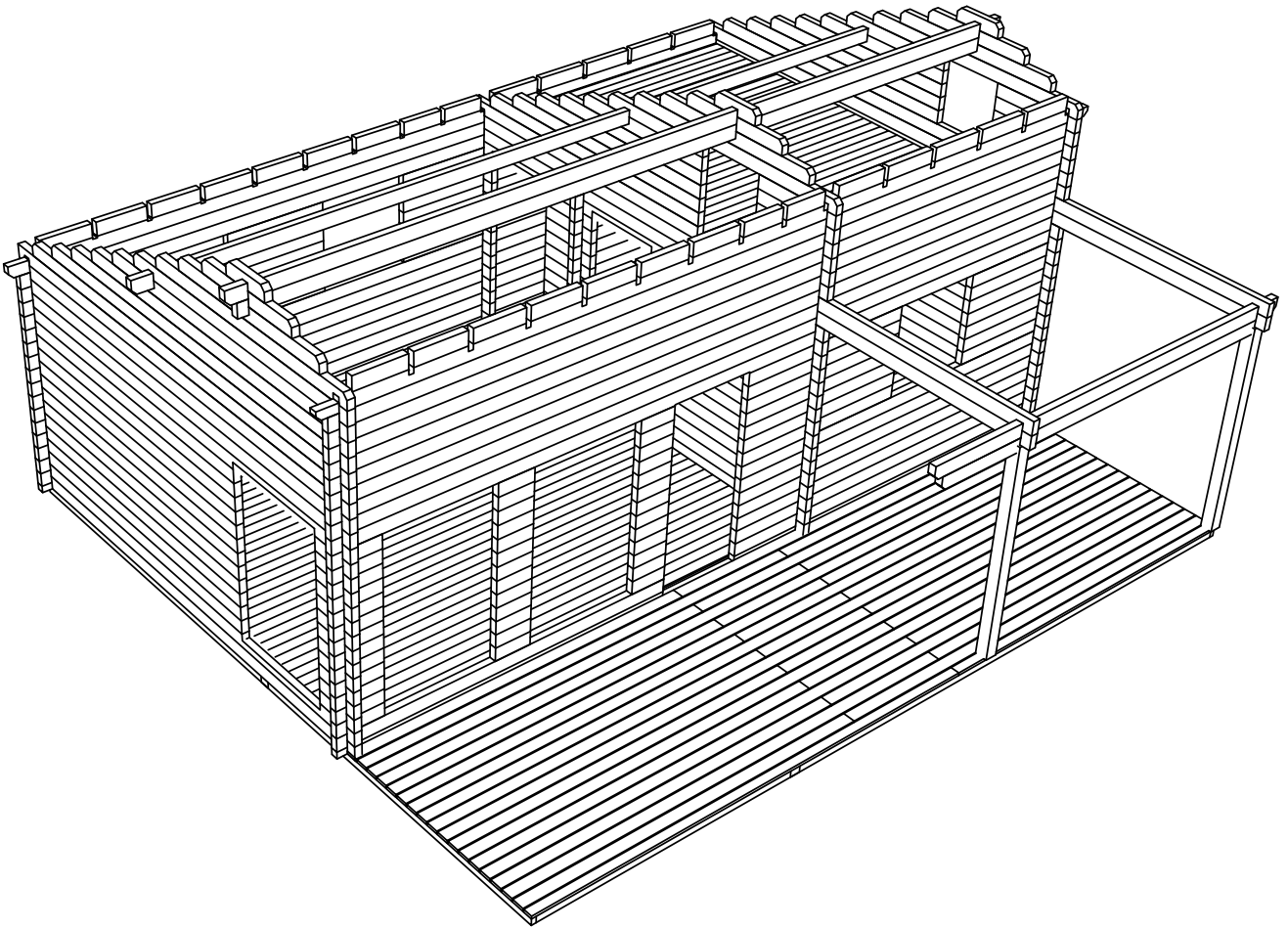

EUFRAAT 70, Art.No. 701902
GRUNDPLAN - GRUNDPLAN - PLAN DE MASSE

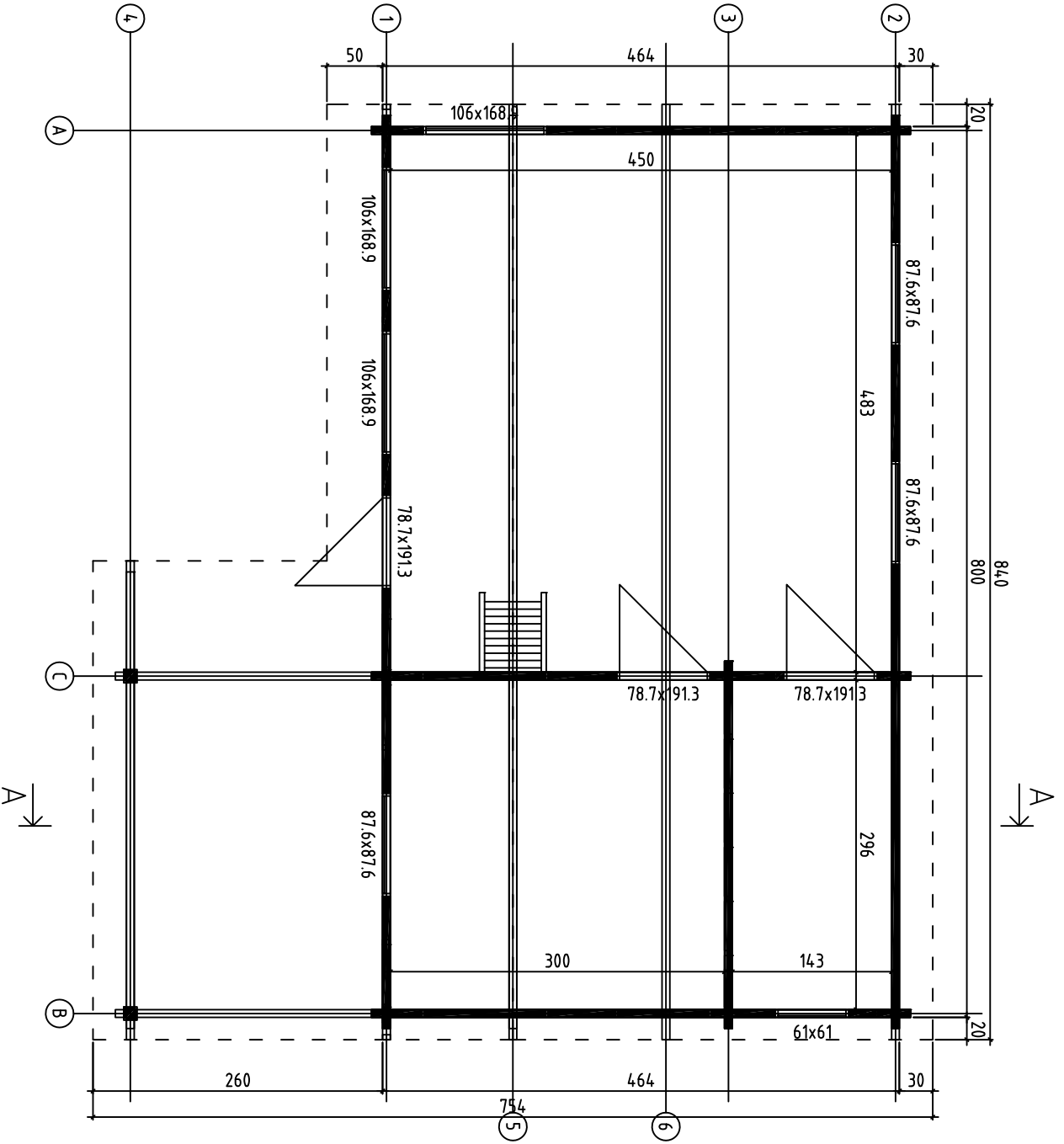

EUFRAAT 70, Art.No. 701902
GRUNDPLAN - GRUNDPLAN - PLAN DE MASSE

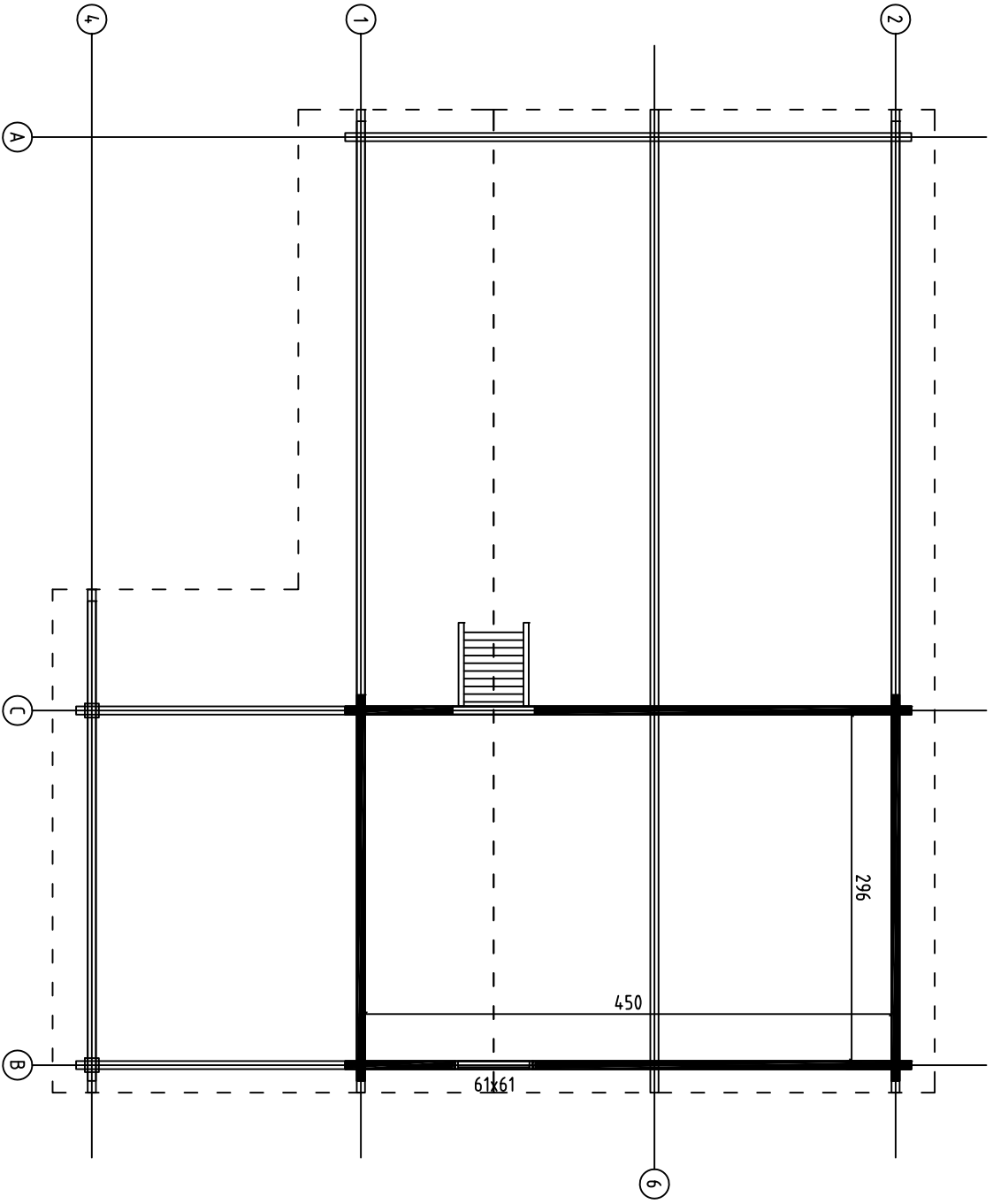

EUFRAT 70, Art.No. 701902
RAFTERS PLAN - DACHSPARREN - PLAN DE CHEVRON

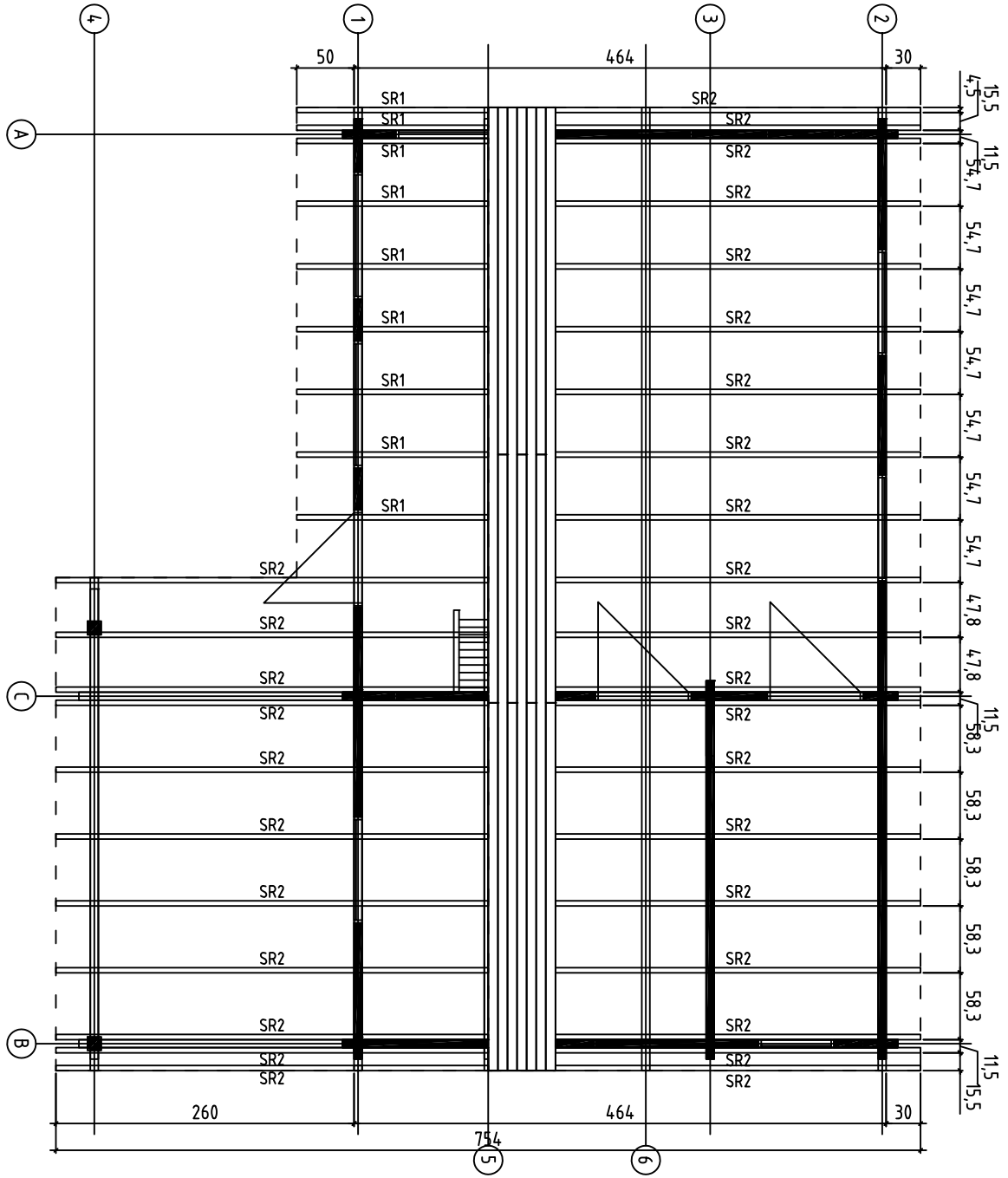

EUFRAAT 70, Art.No.701902
FLOOR BOARDS - FUSSBODENBREITER - PLAN POSE PLANCHER

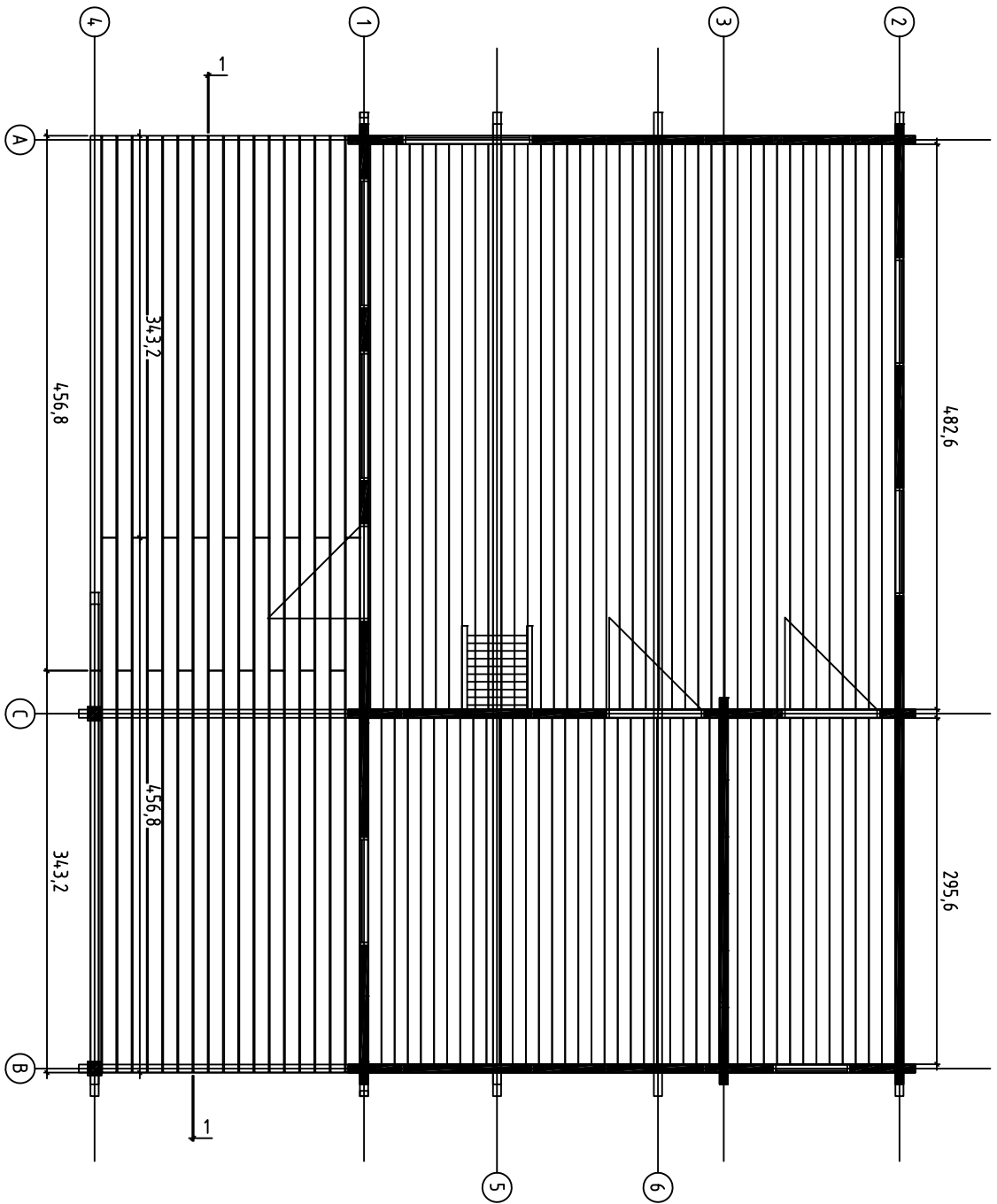

EUFRAAT 70, Art.No.701902
FLOOR BOARDS - FUSSBODENBREITER - PLAN POSE PLANCHER

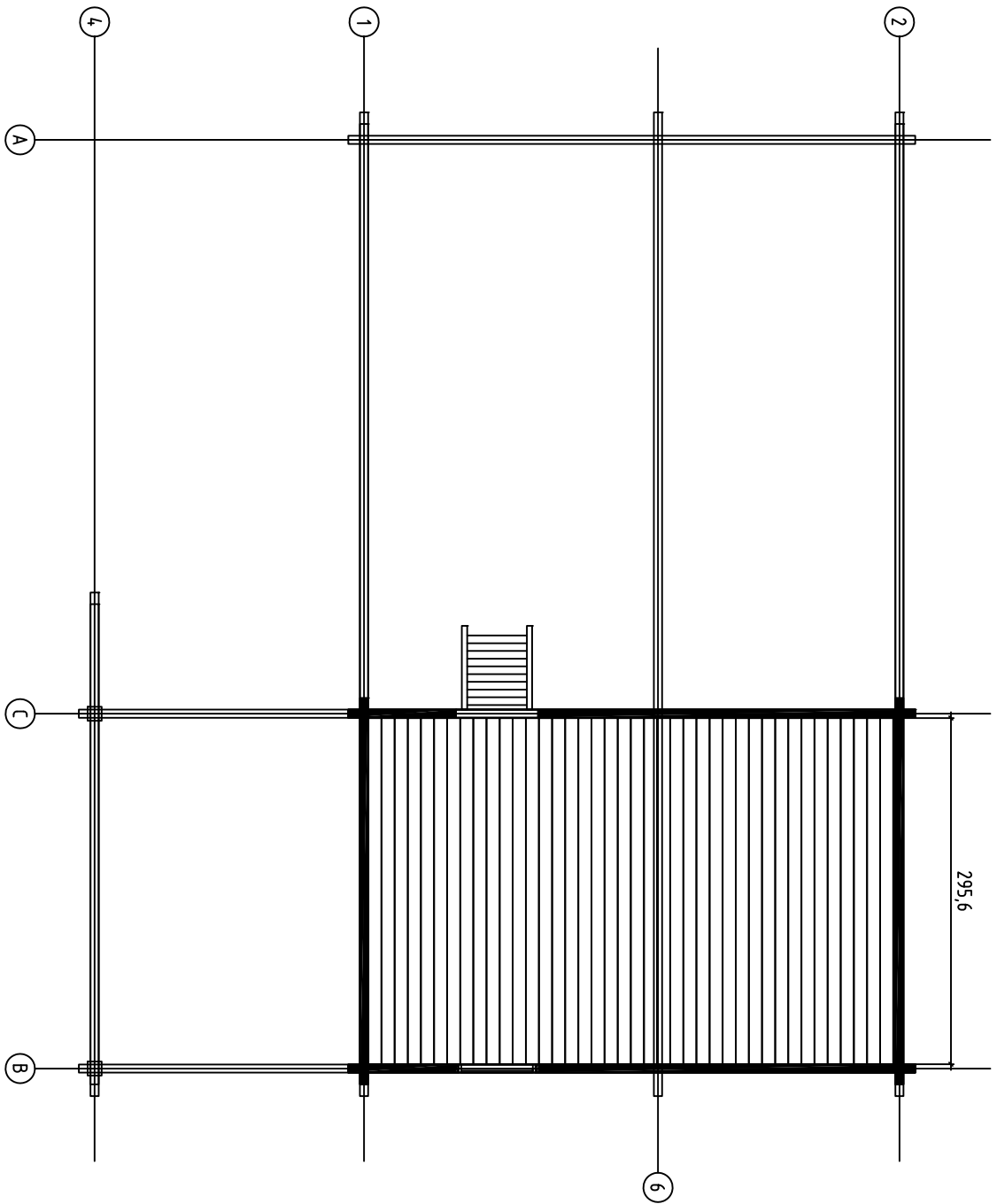

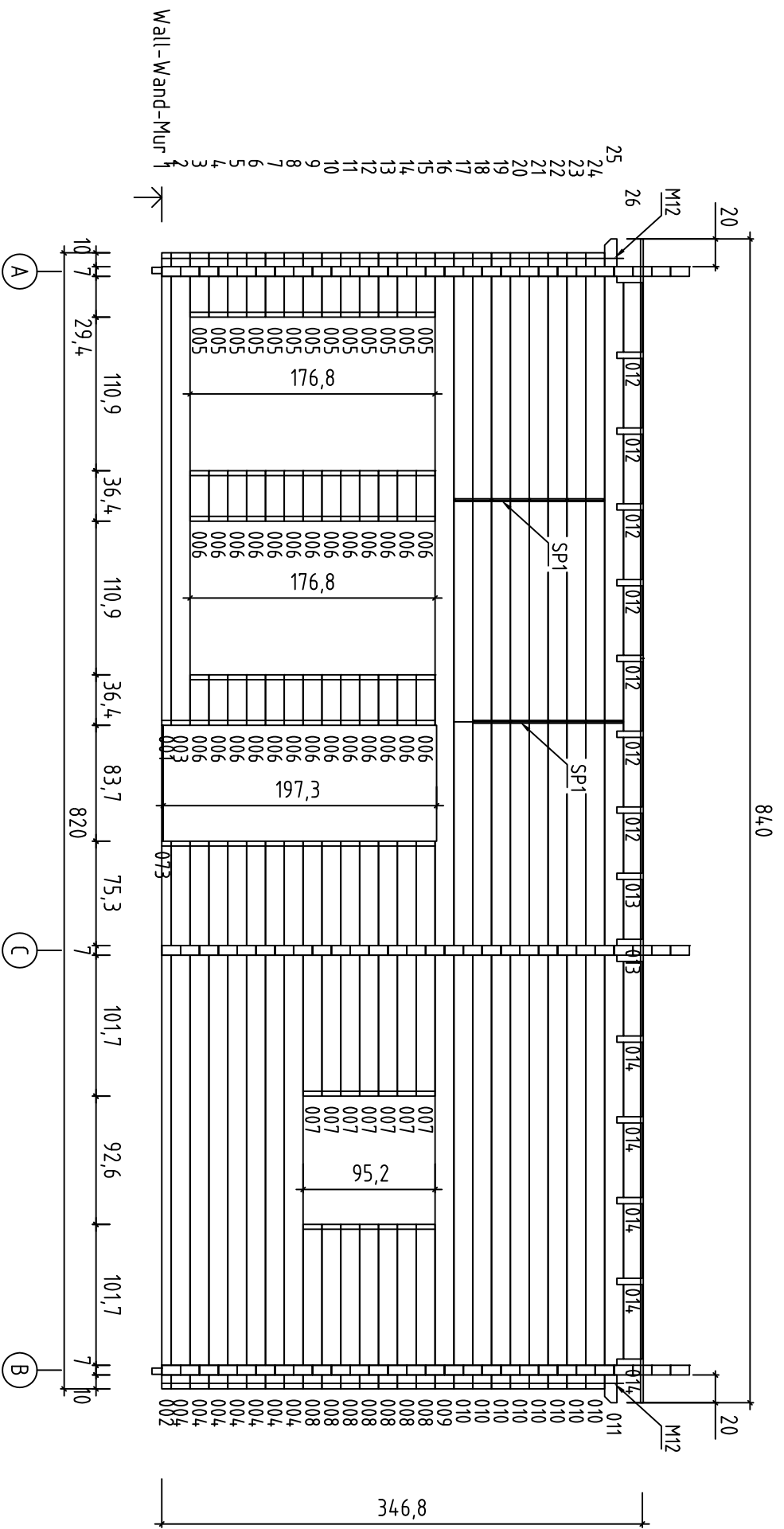

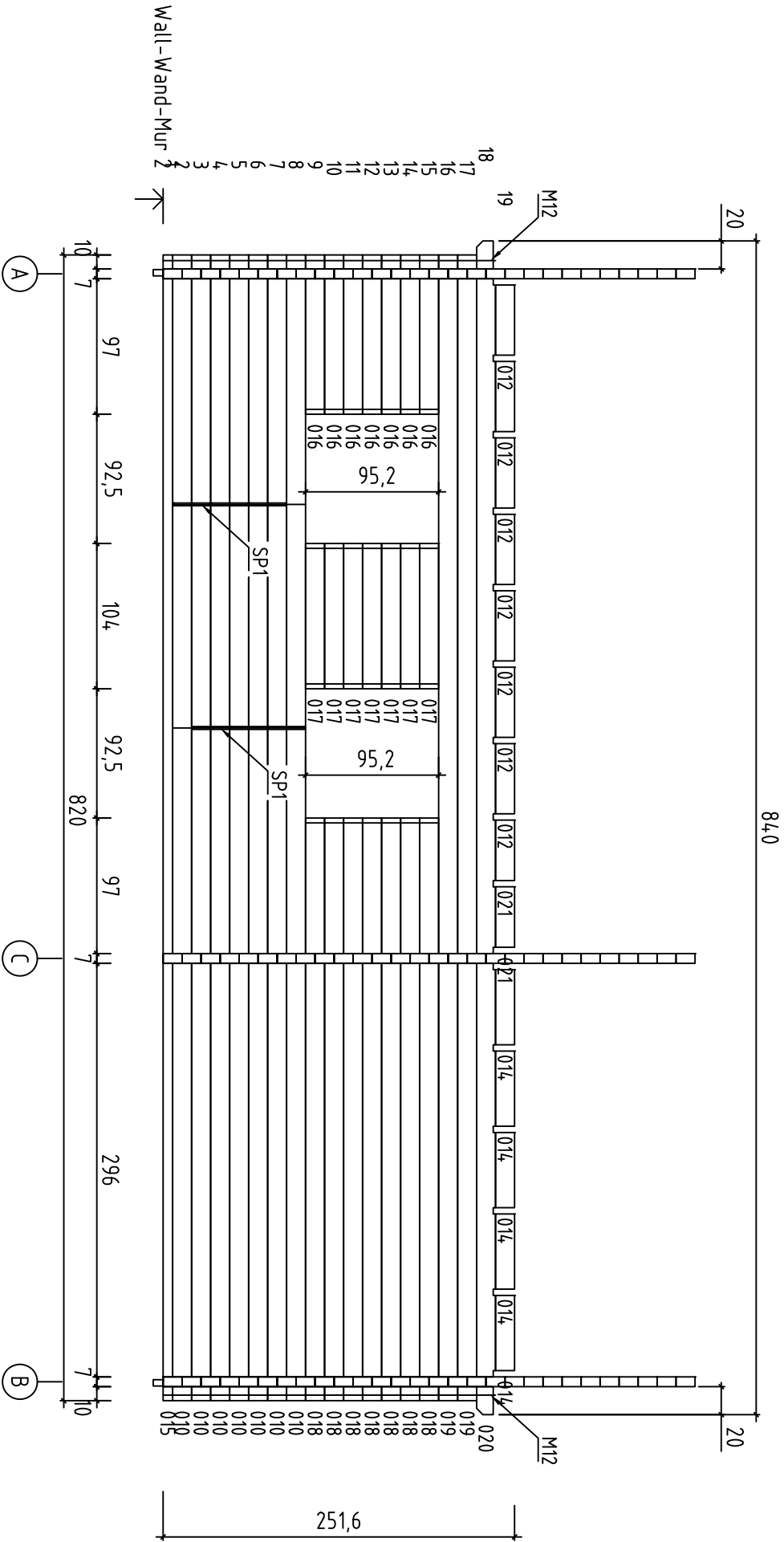

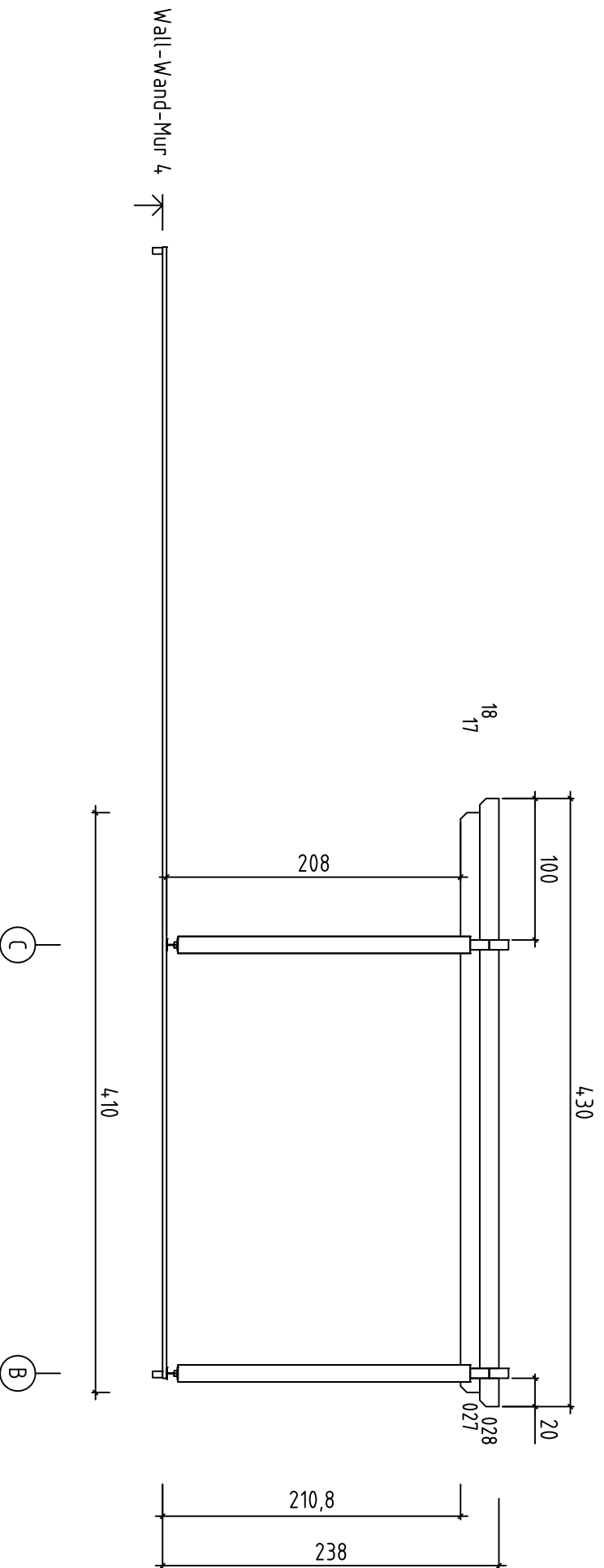

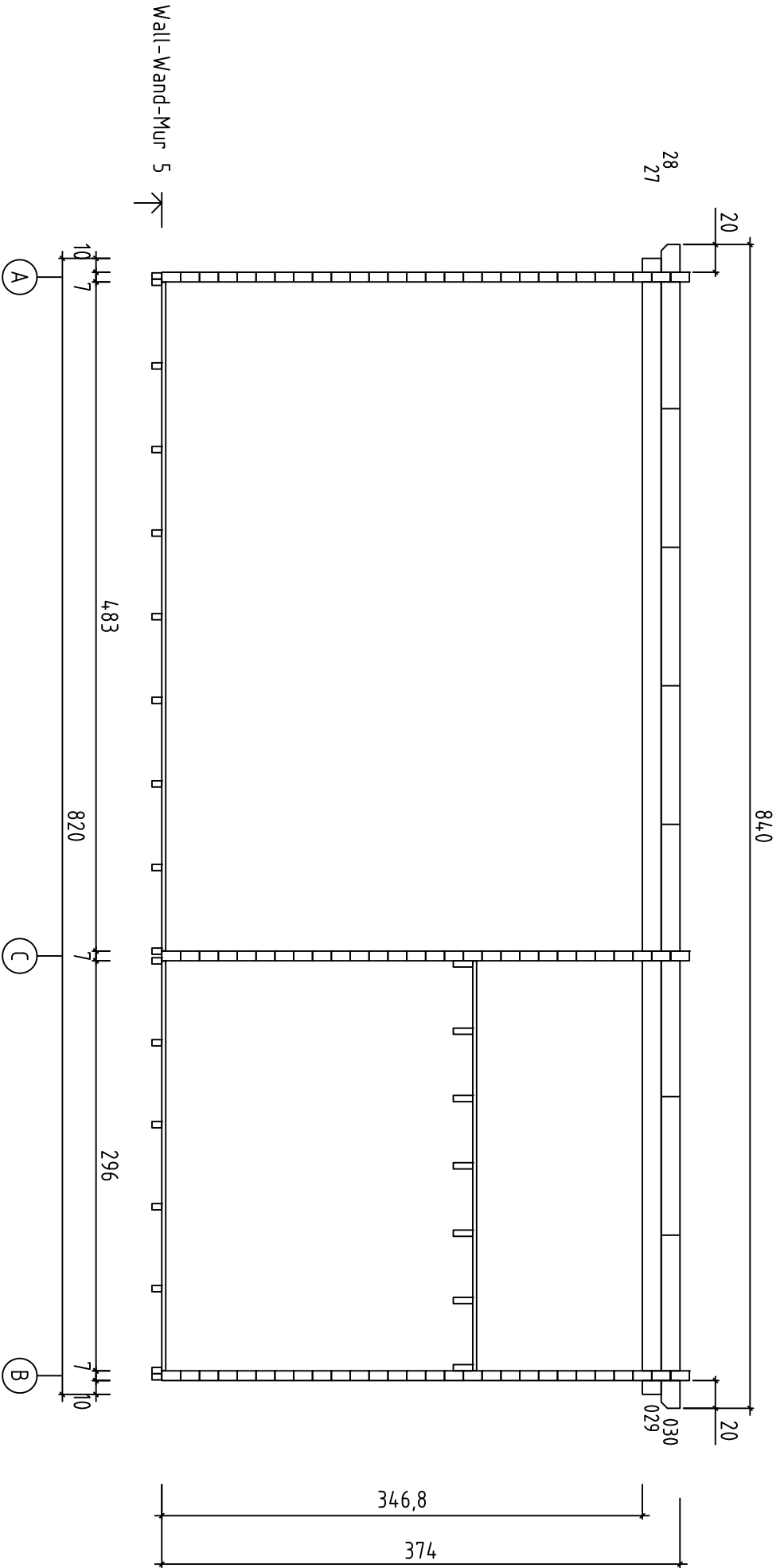

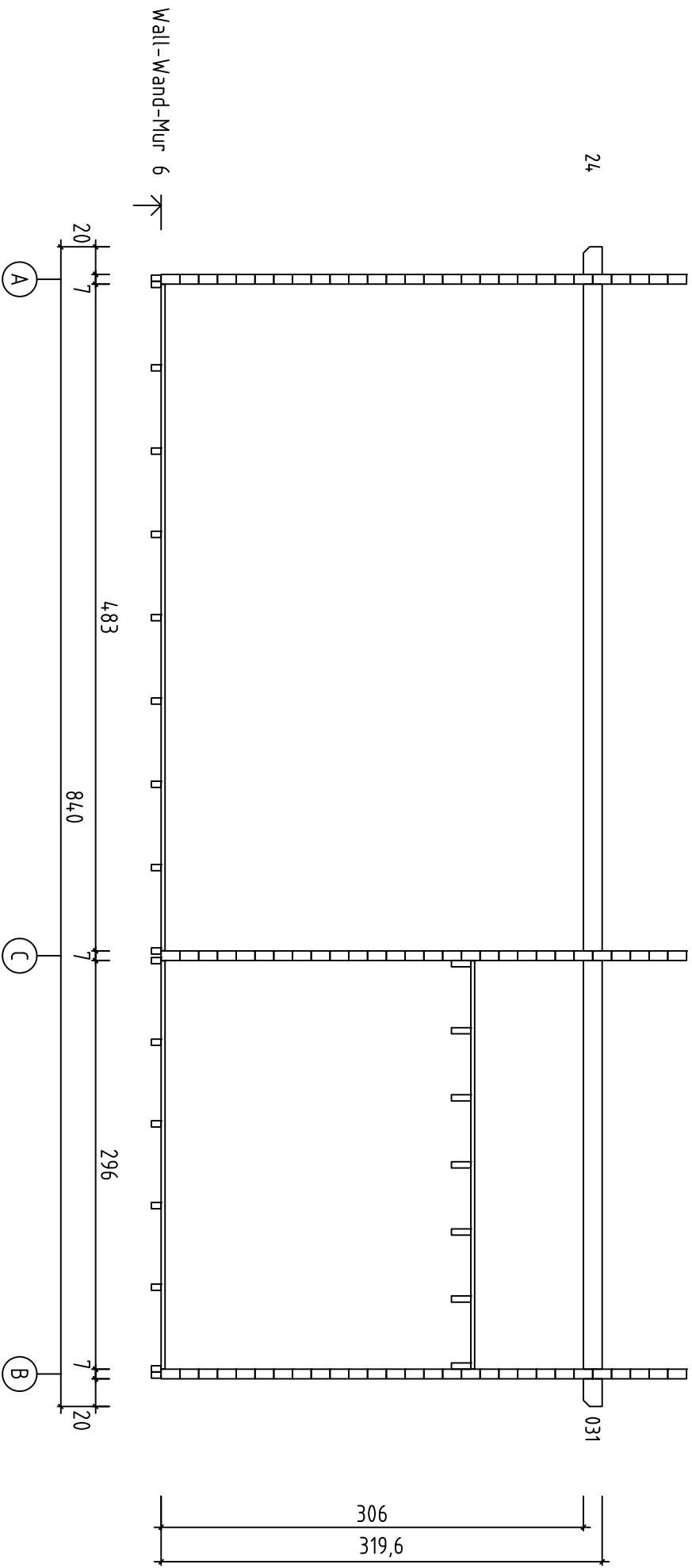

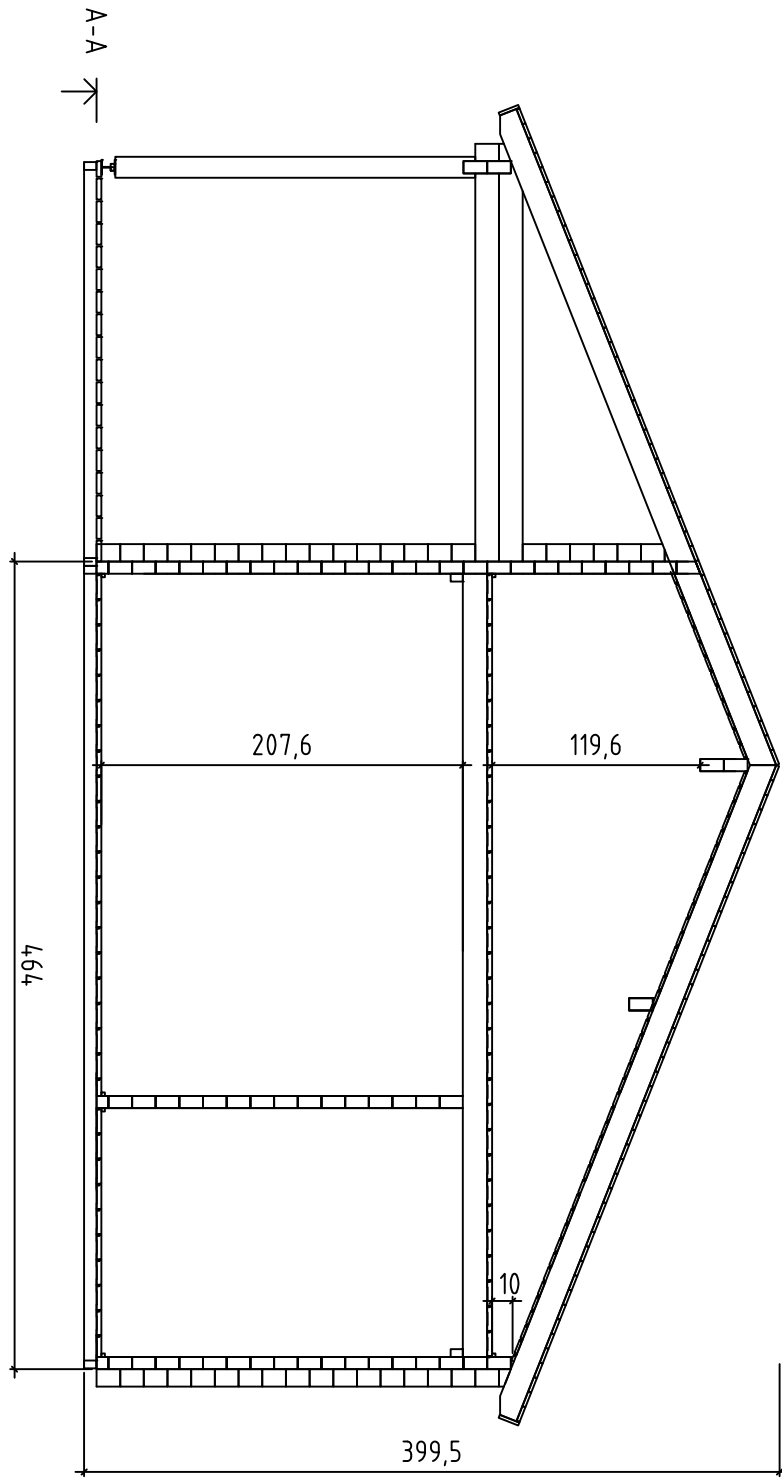

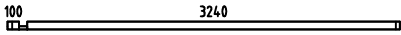
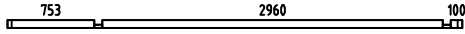
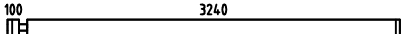
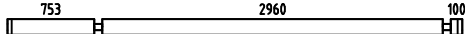

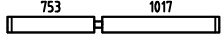
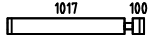
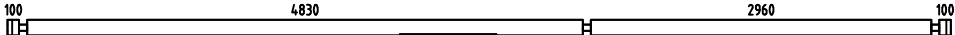
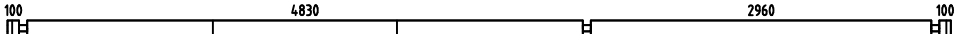
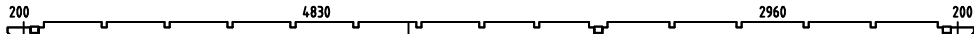



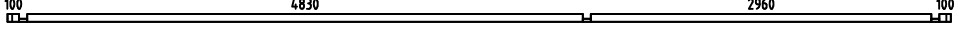
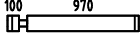
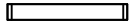
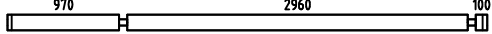
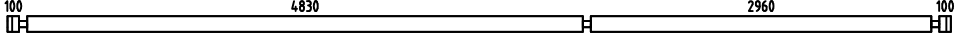
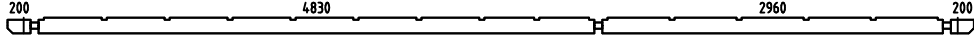

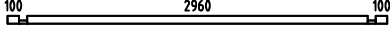
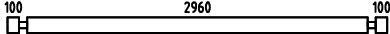
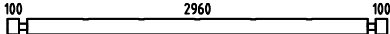







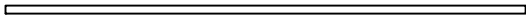
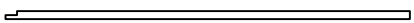





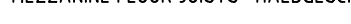



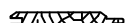
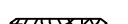



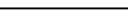
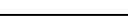

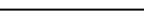
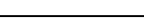





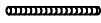
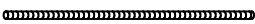







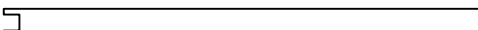
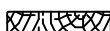
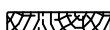
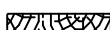
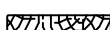

Pos	EUFRAF 70, Art.No.701902 Piece list - Stückliste - Liste des pieces	Q.	P (mm)	L (mm)
001		1	70x68	3410
002		1	70x68	3953
003		1	70x136	3410
004		7	70x136	3953
005		13	70x136	464
006		26	70x136	364
007		7	70x136	1840
008		7	70x136	1187
009		1	70x136	8200
010		15	70x136	8200
011		1	70x136	8400
012		14	70x136	502
013		2	70x136	433
014		10	70x136	538
015		1	70x68	8200
016		7	70x136	1140
017		7	70x136	1040
018		7	70x136	4170
019		2	70x136	8200
020		1	70x136	8400
021		2	70x136	433
022		1	70x68	3300
023		14	70x136	3300
024		1	70x136	3300
025		2	70x136	656

Pos	EUFRAF 70, Art.No.701902 Piece list - Stückliste - Liste des pieces	Q.	P (mm)	L (mm)
026		4	70x136	441
027		1	70x136	4100
028		1	70x136	4300
029		1	70x136	8200
030		1	70x136	8400
031		1	70x136	8400
032		3	70x136	4840
033		1	70x136	4840
034		12	70x136	464
035		12	70x136	3267
036		1	70x136	4840
037		1	70x136	4840
038		2	70x136	4582
039		1	70x136	4242
040		1	70x136	3902
041		1	70x136	3562
042		1	70x136	3222
043		1	70x136	2882
044		3	70x136	2543
045		3	70x136	1866
046		3	70x136	1186
047		3	70x136	506
048		12	70x136	4840
049		5	70x136	3626
050		5	70x136	556

Pos	EUFRAF 70, Art.No.701902 Piece list - Stückliste - Liste des pieces	Q.	P (mm)	L (mm)
051		1	70x136	7140
052		1	70x136	7140
053		5	70x136	941
054		1	70x136	2643
055		1	70x136	2303
056		1	70x136	1963
057		1	70x136	1623
058		1	70x136	1283
059		14	70x136	2203
060		14	70x136	663
061		14	70x136	300
062		1	70x136	4840
063		1	70x136	7140
064		1	70x136	3220
065		1	70x136	3220
066		6	70x136	920
067		1	70x136	2962
068		1	70x136	2622
069		1	70x136	2282
070		1	70x136	1942
071		1	70x136	1602
072		1	70x136	1262
073		3	70x10	837
IAR7	FOUNDATION - FUNDAMENT - FONDATION 	1	45x70	5317
IAR6	FOUNDATION - FUNDAMENT - FONDATION 	3	45x70	5317

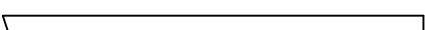
Pos	EUFRAT 70, Art.No.701902 Piece list - Stückliste - Liste des pieces		Q.	P (mm)	L (mm)
IAR3	FOUNDATION - FUNDAMENT - FONDATION 		15	45x70	4520
IAR2	FOUNDATION - FUNDAMENT - FONDATION 		2	45x70	3515
IAR1	FOUNDATION - FUNDAMENT - FONDATION 		2	45x70	3515
IAR8	FOUNDATION - FUNDAMENT - FONDATION 		1	45x70	2683
IAR5	FOUNDATION - FUNDAMENT - FONDATION 		3	45x70	2683
IAR4	FOUNDATION - FUNDAMENT - FONDATION 		13	45x70	2230
VT3	MEZZANINE FLOOR JOISTS - HALBGESCHOSS BALKEN - SOLIVES DE PLANCHER MEZZANINE 		5	45x140	4500
VT1	MEZZANINE FLOOR JOISTS - HALBGESCHOSS BALKEN - SOLIVES DE PLANCHER MEZZANINE 		2	45x140	3000
VT2	MEZZANINE FLOOR JOISTS - HALBGESCHOSS BALKEN - SOLIVES DE PLANCHER MEZZANINE 		2	45x140	1430
VT4	MEZZANINE FLOOR JOISTS - HALBGESCHOSS BALKEN - SOLIVES DE PLANCHER MEZZANINE 		2	45x70	2960
SR2	RAFTER - DACHSPARREN - CHEVRON 		31	45x140	4061
SR1	RAFTER - DACHSPARREN - CHEVRON 		9	45x140	1799
STP	CEILING BOARDS - DECKENBRETTER - VOLIGES SOUS PLAFOND		44	111x15	4826
STP	CEILING BOARDS - DECKENBRETTER - VOLIGES SOUS PLAFOND		44	111x15	2956
PTL	FLOOR BOARDS - FUSSBODENBRETTER - LAME DE PLANCHER		41	112x28	4826
PTL	FLOOR BOARDS - FUSSBODENBRETTER - LAME DE PLANCHER		81	112x28	2956
	ROOF BOARDS - DACHBRETTER - VOLIGES		33	90x18	5372
	ROOF BOARDS - DACHBRETTER - VOLIGES		33	90x18	5192
	ROOF BOARDS - DACHBRETTER - VOLIGES		26	90x18	4300
	ROOF BOARDS - DACHBRETTER - VOLIGES		33	90x18	3208
	ROOF BOARDS - DACHBRETTER - VOLIGES		33	90x18	3028
SV2	TERRACE BOARDS - TERRASSENBRETTER - PLANCHER DE TERRASSE		18	120x28	4568
SV2	TERRACE BOARDS - TERRASSENBRETTER - PLANCHER DE TERRASSE		18	120x28	3433
LL	CEILING FILLET - DECKELEISTE - PROFIL DE FINITION POUR SOUS PLAFOND			15x40	65.4 m.
	FLOOR FILLET-FUSSBODENLEISTE - CORNIERE DE FINITION DU PLANCHER			18x18	54.2 m.

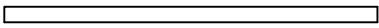
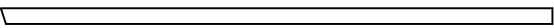
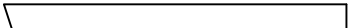
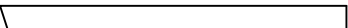
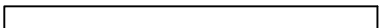
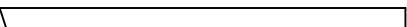
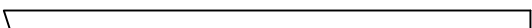
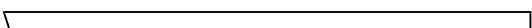
Pos	EUFRAT 70, Art.No.701902 Piece list - Stückliste - Liste des pieces		Q.	P (mm)	L (mm)
DPL	ROOFING FELT FILLET - DACHPAPPENLEISTE - BAGUETTE DE FIXATION DU FEUTRE BITUMEUX		1	18x58	1870
DPL	ROOFING FELT FILLET - DACHPAPPENLEISTE - BAGUETTE DE FIXATION DU FEUTRE BITUMEUX		4	18x58	4130
M12	TREADED ROD M12 - GEWINDESTANGE M12 - TIGE FILETÉE M12		2		395
M12	TREADED ROD M12 - GEWINDESTANGE M12 - TIGE FILETÉE M12		2		1315
M12	TREADED ROD M12 - GEWINDESTANGE M12 TIGE FILETÉE M12		4		2000
LPL	FIXING FILLET - FIXIRUNGSLEISTE - PROFIL DE FIXATION		4	20x70	610
LPL	FIXING FILLET - FIXIRUNGSLEISTE - PROFIL DE FIXATION		4	20x70	650
LPL	FIXING FILLET - FIXIRUNGSLEISTE - PROFIL DE FIXATION		3	20x70	787
LPL	FIXING FILLET - FIXIRUNGSLEISTE - PROFIL DE FIXATION		6	20x70	876
LPL	FIXING FILLET - FIXIRUNGSLEISTE - PROFIL DE FIXATION		6	20x70	916
LPL	FIXING FILLET - FIXIRUNGSLEISTE - PROFIL DE FIXATION		6	20x70	1060
LPL	FIXING FILLET - FIXIRUNGSLEISTE - PROFIL DE FIXATION		6	20x70	1729
LPL	FIXING FILLET - FIXIRUNGSLEISTE - PROFIL DE FIXATION		6	20x70	1933
P	POST - PFOSTEN - POTEAU		2	120x120	2070
TB	EAVES BOARD - TRAUFBRETT - BANDEAU DE TOIT		1	18x120	3322
TB	EAVES BOARD - TRAUFBRETT - BANDEAU DE TOIT		1	18x120	4100
TB	EAVES BOARD - TRAUFBRETT - BANDEAU DE TOIT		1	18x120	4300
TB	EAVES BOARD - TRAUFBRETT - BANDEAU DE TOIT		1	18x120	5078
TBE6	FIXING FILLET FOR WINDOW - FIXIRUNGSLEISTE FÜR FENSTER - PROFIL DE FIXATION DES FENETRES		4	28x34	650
TBE6	FIXING FILLET FOR WINDOW - FIXIRUNGSLEISTE FÜR FENSTER - PROFIL DE FIXATION DES FENETRES		6	28x34	916
TBE6	FIXING FILLET FOR WINDOW - FIXIRUNGSLEISTE FÜR FENSTER - PROFIL DE FIXATION DES FENETRES		2	28x34	1560
TBE6	FIXING FILLET FOR WINDOW - FIXIRUNGSLEISTE FÜR FENSTER - PROFIL DE FIXATION DES FENETRES		4	28x34	1729
TBE6	FIXING FILLET FOR DOOR - FIXIRUNGSLEISTE FÜR TÜR - PROFIL DE FIXATION DES PORTES		4	28x34	1826
TBE6	FIXING FILLET FOR DOOR - FIXIRUNGSLEISTE FÜR TÜR - PROFIL DE FIXATION DES PORTES		2	28x34	1920
GL3	GABLE MOULDING - GIBELLEISTE PLANCHE DE RIVE		1	18x90	1870

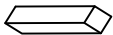
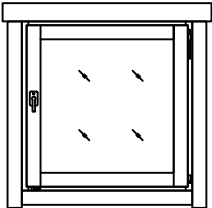
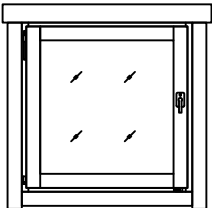
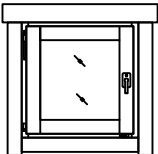
Pos	EUFRAF 70, Art.No.701902 Piece list - Stückliste - Liste des pieces	Q.	P (mm)	L (mm)
GL3	GABLE MOULDING - GIBELLEISTE - PLANCHE DE RIVE 	1	18x90	2309
GL3	GABLE MOULDING - GIBELLEISTE PLANCHE DE RIVE 	3	18x90	4130
GL	GABLE MOULDING - GIBELLEISTE - PLANCHE DE RIVE 	1	18x120	1835
GL	GABLE MOULDING - GIBELLEISTE - PLANCHE DE RIVE 	1	18x120	1870
GL	GABLE MOULDING - GIBELLEISTE - PLANCHE DE RIVE 	1	18x120	2309
GL	GABLE MOULDING - GIBELLEISTE PLANCHE DE RIVE 	1	18x120	2834
GL	GABLE MOULDING - GIBELLEISTE PLANCHE DE RIVE 	3	18x120	4094
GL	GABLE MOULDING - GIBELLEISTE PLANCHE DE RIVE 	3	18x120	4130
LR	LADDER - LEITER - ECHELLE 	1		
GS	GABLE SEGMENT-DECKBLATT - LOSANGE DE FINITION 	2		
SP1	HIDDEN FIXING - HOLZDÜBEL - TOURILLON BOIS 	14		
MON	MONTAGE SET - MONTAGE-SET - JEU DE MONTAGE	1		
Premiu m A.0P	WINDOW-FENSTER-FENETRE 916x916 	2		
Premiu m A.0V	WINDOW-FENSTER-FENETRE 916x916 	1		
Premium A.0V.c	WINDOW-FENSTER-FENETRE 650x650 	2		

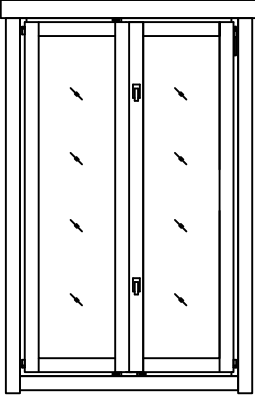
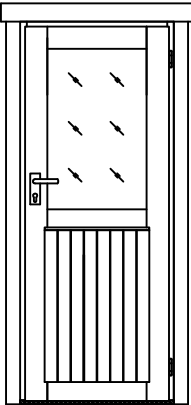
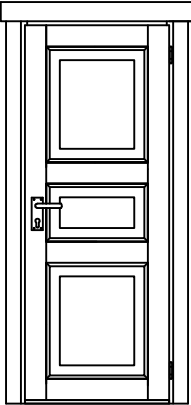
Pos	EUFRAT 70, Art.No.701902 Piece list - Stückliste - Liste des pieces	Q.	P (mm)	L (mm)
Premi um TA .0P.b	WINDOW-FENSTER-FENETRE 1100x1729 	3		
Premiu m U.20P	DOOR-TÜR-PORTE 827x1933 	1		
U.3TP	DOOR-TÜR-PORTE 827x1933 	2		