

Assembly, installation and maintenance manual

Montage-, Aufbau- und Wartungsanleitung • Assemblage, manuel de montage et d'entretien • Montaje, instalación y mantenimiento • Manuale di montaggio, installazione e manutenzione • Monterings- og vedlikeholdsmanual • Monterings-, installations- och underhållsmanual • Kokoamis-, asennus- ja huolto-ohje • Vejledning for montering og vedligehold • Handleiding voor montage, installatie en onderhoud • Manual de montagem, instalação e manutenção • Návod k montáži, instalaci a údržbě • Instrukcja montażu, instalacji i konserwacji • Surinkimo, montavimo ir priežiūros vadovas • Montāžas, uzstādīšanas un apkopes rokasgrāmata • Руководство по сборке и обслуживанию • Montaaži-, paigaldus- ja säilitamise juhend















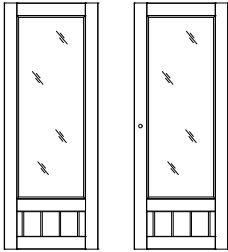
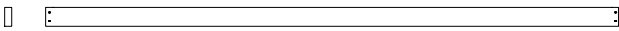
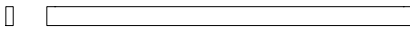

Glasshouse **PA44-3048**

Treatment options, Item code

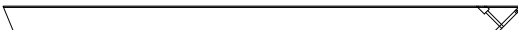
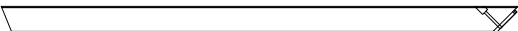
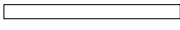

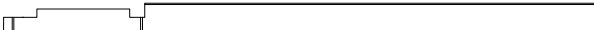
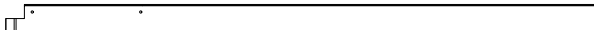

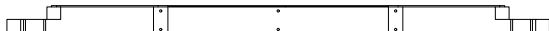
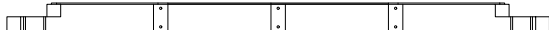



• Behandlungsoptionen, Artikel-Code • Traitement options, code de l'article • Opciones de tratamiento, código del artículo • Opzioni di trattamento, codice articolo • Behandlingsalternativer, artikkelnummer • Behandlingsalternativ, varukod • Käsittelevaihtoehdot, yksikön koodi • Behandlingsmuligheder, artikel nummer • Behandlingsopties, artikelnummer • Opções de tratamento, código do artigo • Povrchové úpravy, kód položky • Możliwości leczenia, kod produktu • Apdorojimo variantai, prekės kodas • Apstrādes iespējas, artikula kods • Варианты обработки, код изделия • Tõõtlusvõimalused, tootekood

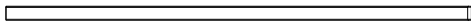
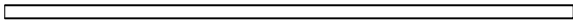

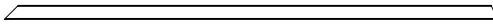
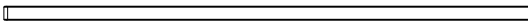
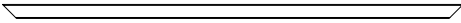
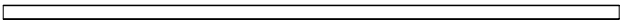
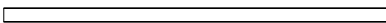
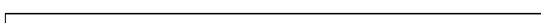
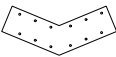





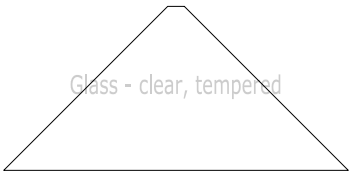
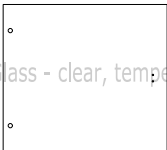

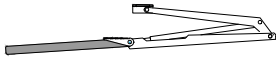

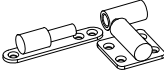
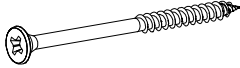
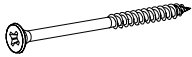



GYVPI 109532

<p>Factory inspection by • Werkskontrolle durch • Contrôle à partir de l'usine par • Inspector de fábrica • Collaudato da • Fabrikkkontroll utført av • Fabriksbesiktigat av • Tehtaan tarkastaja • Fabriks Kontrol udført af • Fabrikscontrole door • Inspeção de fábrica, por: • Zkontrolováno ve výrobním závodě • Kontrola fabryczna do • Apžiūrą gamykloje atliko • Rūpnīcas pārbaudi veicis • Заводской контроль • Tehase kontroll teostatud:</p> <p>.....</p>	<p>Date • Datum • Date • Fecha • Data • Dato • Datum • Päiväys • Dato • Datum • Data • Datum • Data • Datums • Data • Дата • Kuupäev:</p> <hr/> <p>Pack number • Pack Nr. • Packet n° • Bulto N° • Pacco N. • Serienr • Produktionsnummer • Pakettinro • Pakke nr. • Pak nr. • Número de embalagem • Číslo balení • Numer opakowania • Pakuotės numeris • Iepakojuma numurs • Упаковочный номер • Pakinumber:</p>
---	---

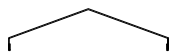
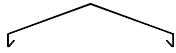
Pos.	Description	Measures (mm)	Pcs
EL1		657 x 390 x 45	2
EL2		2810 x 390 x 45	1
EL3A		2370 x 390 x 45	2
EL3B		2370 x 390 x 45	2
KUL-145 KUL-145-2		693 x 1818 x 40	1+1
1		4828 x 120 x 45	2
2		2910 x 120 x 45	2
3		1502 x 95 x 44	2
4		1502 x 95 x 44	2
5		1562 x 95 x 44	14
6		1879 x 95 x 44	2
7		1879 x 95 x 44	2
8		554 x 45 x 45	4
9		1879 x 95 x 44	14
10		1893 x 95 x 44	3
11		1893 x 95 x 44	1
12		1893 x 95 x 44	1
13		2182 x 95 x 44	1
14		2182 x 95 x 44	1
15		661 x 91 x 44	2
16		4976 x 240 x 80	1

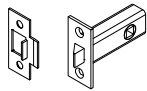
esmaspāev, 18. oktobar 2021 15:43:20

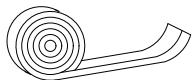
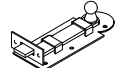
Pos.	Description	Measures (mm)	Pcs
20		1502 x 45 x 12	20
21		1827 x 45 x 12	7
22		1478 x 45 x 12	4
23		1814 x 45 x 12	4
24		1910 x 45 x 12	18
25		1895 x 45 x 12	2
26		2410 x 45 x 12	4
27		1383 x 45 x 12	2
28		1818 x 45 x 12	1
33		360 x 173 x 15	32
101		578 x 1115 x 4	16
102		578 x 1895 x 4	12
103		578 x 1030 x 4	4
104		680 x 1458 x 4	4
105		704 x 1458 x 4	2
106		700 x 1862x 4	2
107		620 x 910 x 4	4

Pos.	Description	Measures (mm)	Pcs
F1		Thermivent 7kg	4
F2		55 x 60	8
F3		62 x 40 x 13	18
F4	 QHP15x57Zn	15 x 57	4
F5	 QKRPP6x120ZnTX	Ø 6 X 120	8
F6	 QKRPP5x90ZnTX	Ø 5 X 90	115
F7	 QKRYP5x55RVTX	Ø 5 X 55	390
F8	 QKRYP4_2x38RVTX	Ø 4.2 X 38	310
F9	 QKRPP3_5x40ZnTX	Ø 3.5 X 40	12
F10	 QKRPP4x25Zn	Ø 4 X 25	6
F11	 Polt M6	Ø 6 X 200	9
F12	 QMUUK6Zn	M6	9
F13	 QSE6x18Zn	Ø 6 X 18	18
F14		2488 x 120 x 30	2
F15		100 x 121 x 31	1
F16	 QHA150Zn	150 mm	2
F17	 QUNAL		1set
F18	 QRUAu		1set
F19	 QLIKA		1set
F20	 QTI3x8MU	0.8 m	1
F21	 QR35100Zn	35 x 100	2
F22	 QKRYP3x16Zn	Ø 3 X 16	16

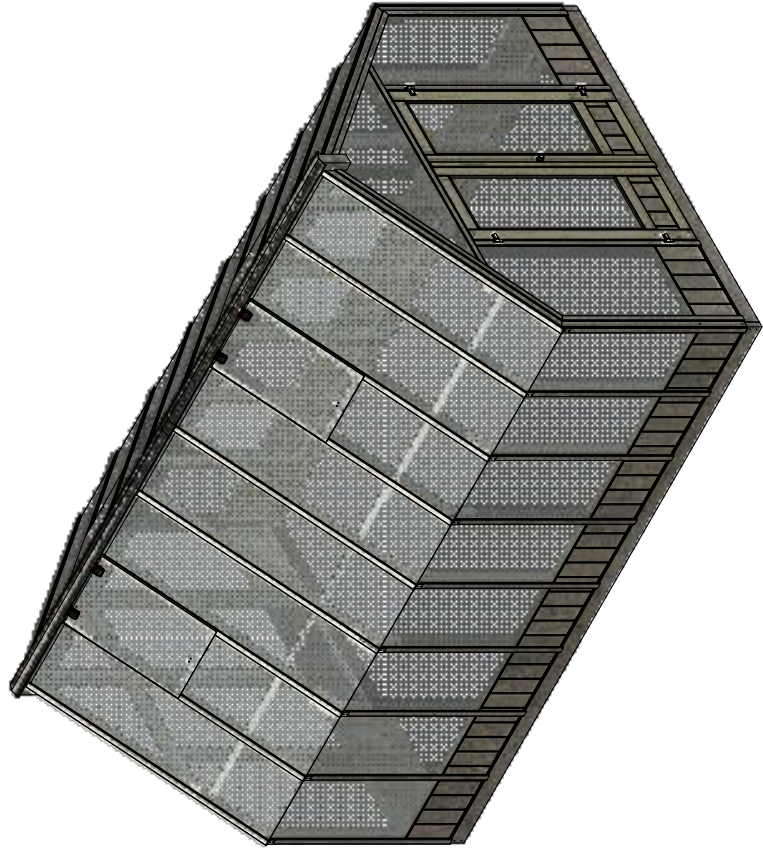
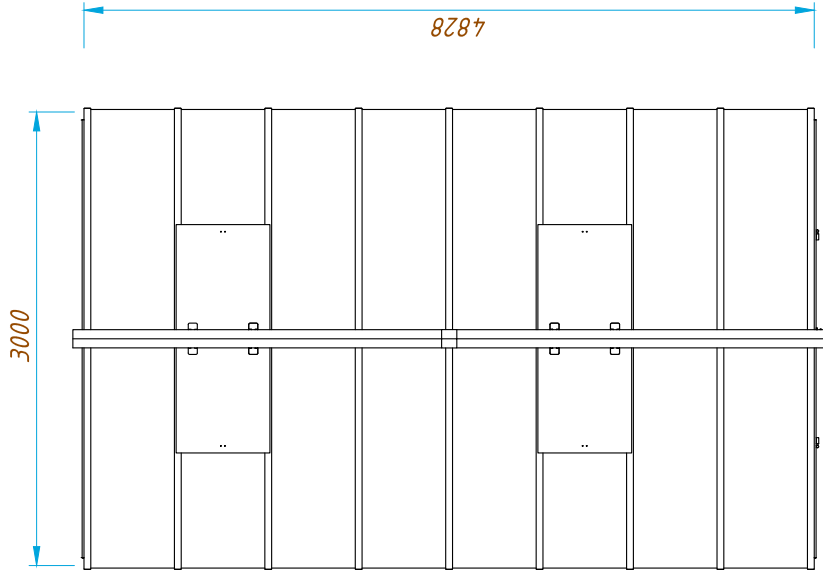
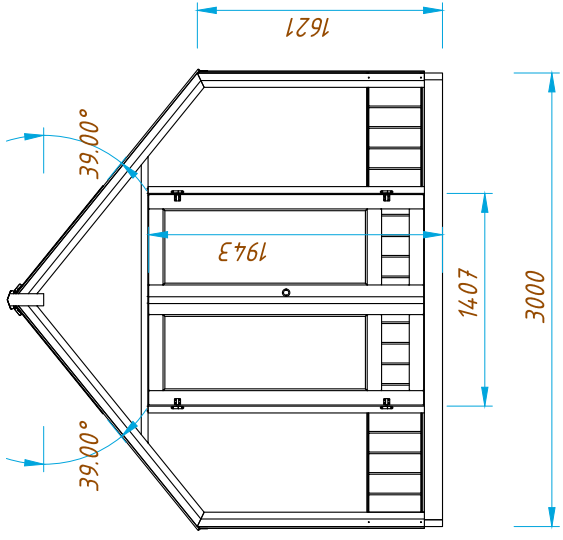
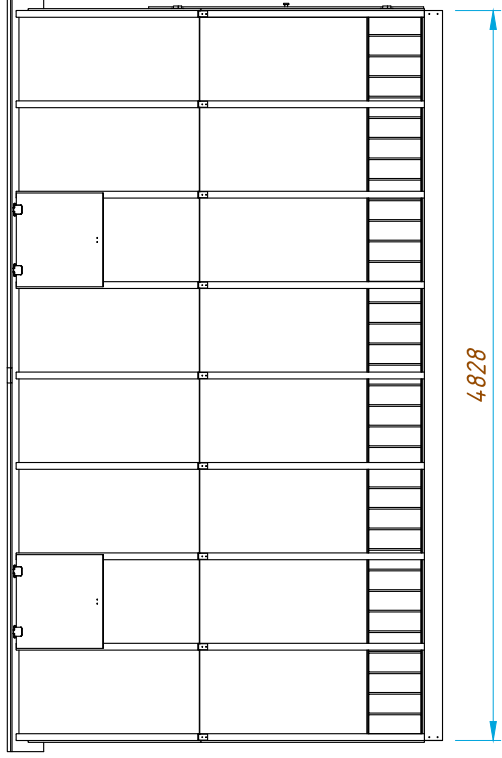
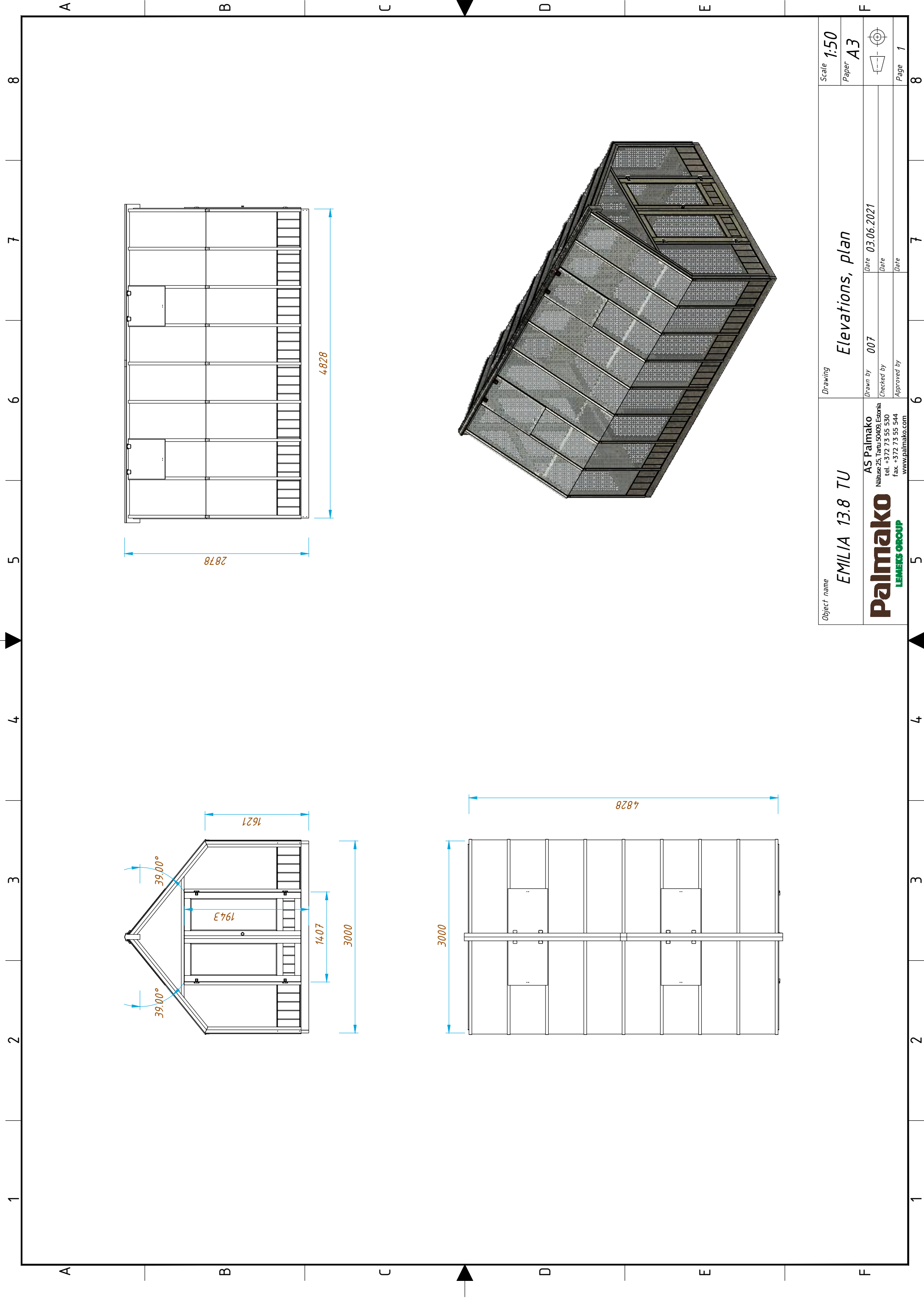

Scale	1:50	Drawing	Elevations, plan		
Paper	A3		Object name	EMILIA 13.8 TU	
 Page 1	Drawn by	007	Date	03.06.2021	AS Palmako Näituse 25, Tartu, 50409, Estonia tel. +372 73 55 530 fax +372 73 55 544 www.palmako.com
	Checked by		Date		
	Approved by		Date		

det 1 - 2 pcs
det 2 - 2 pcs
F5 - 8 pcs

1

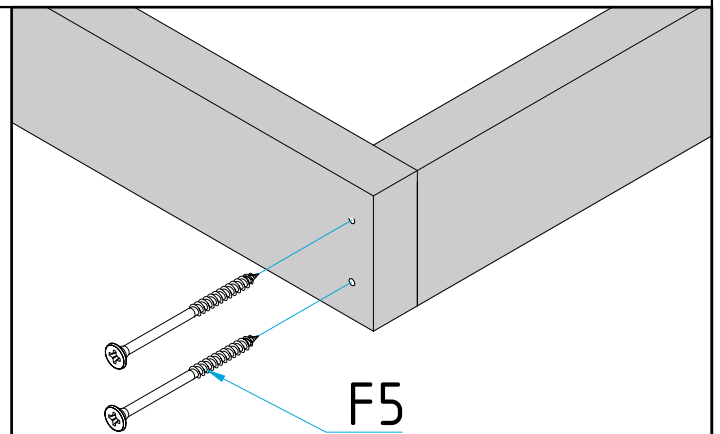
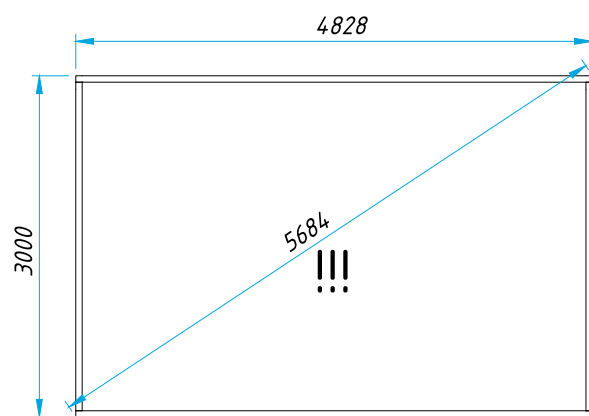
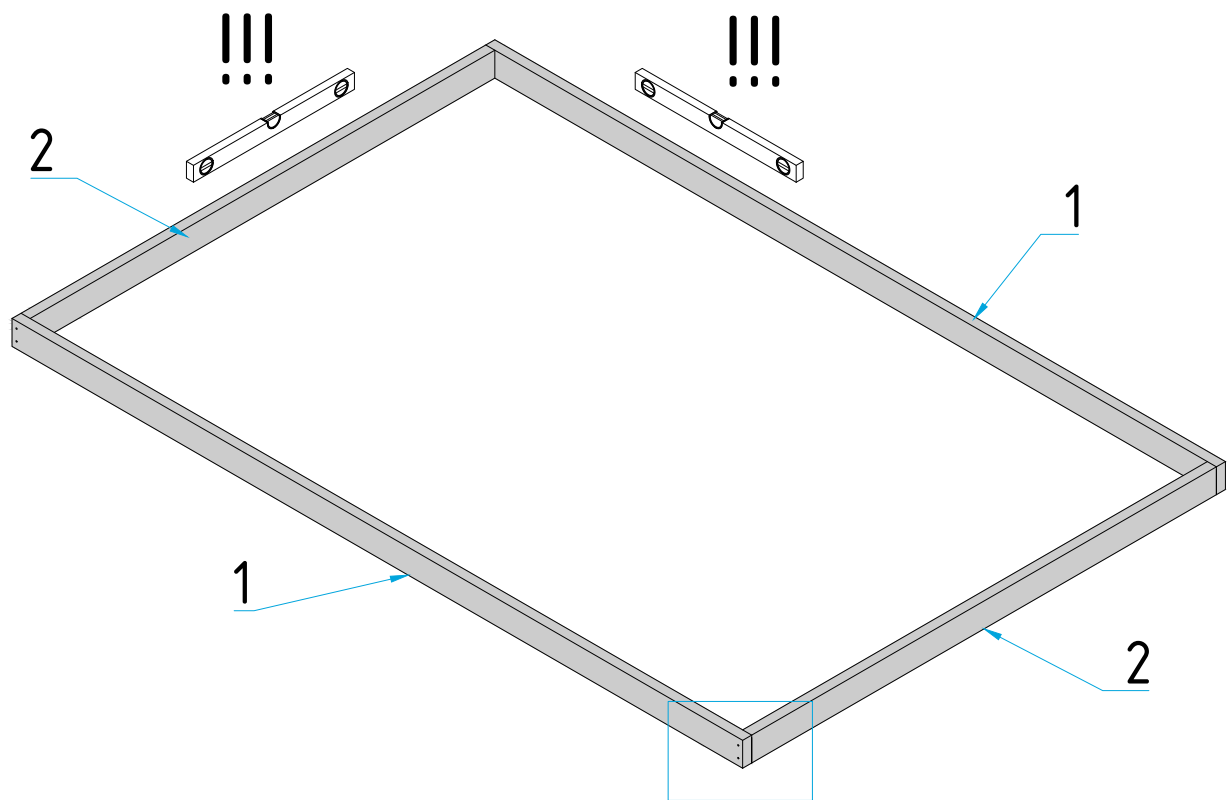

- EL 1 - 2 pcs
- EL 2 - 1 pcs
- EL 3A - 2 pcs
- EL 3B - 2 pcs
- F6 - 26 pcs

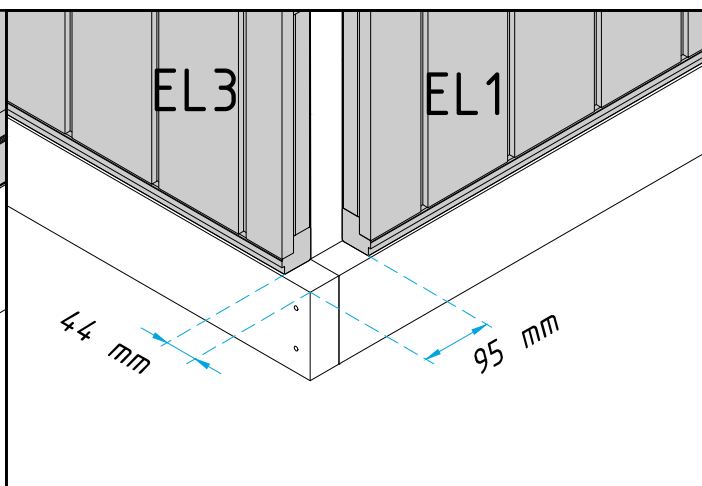
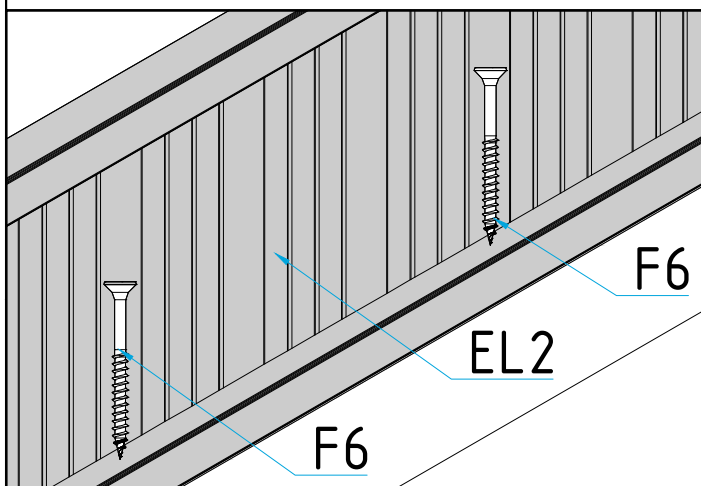
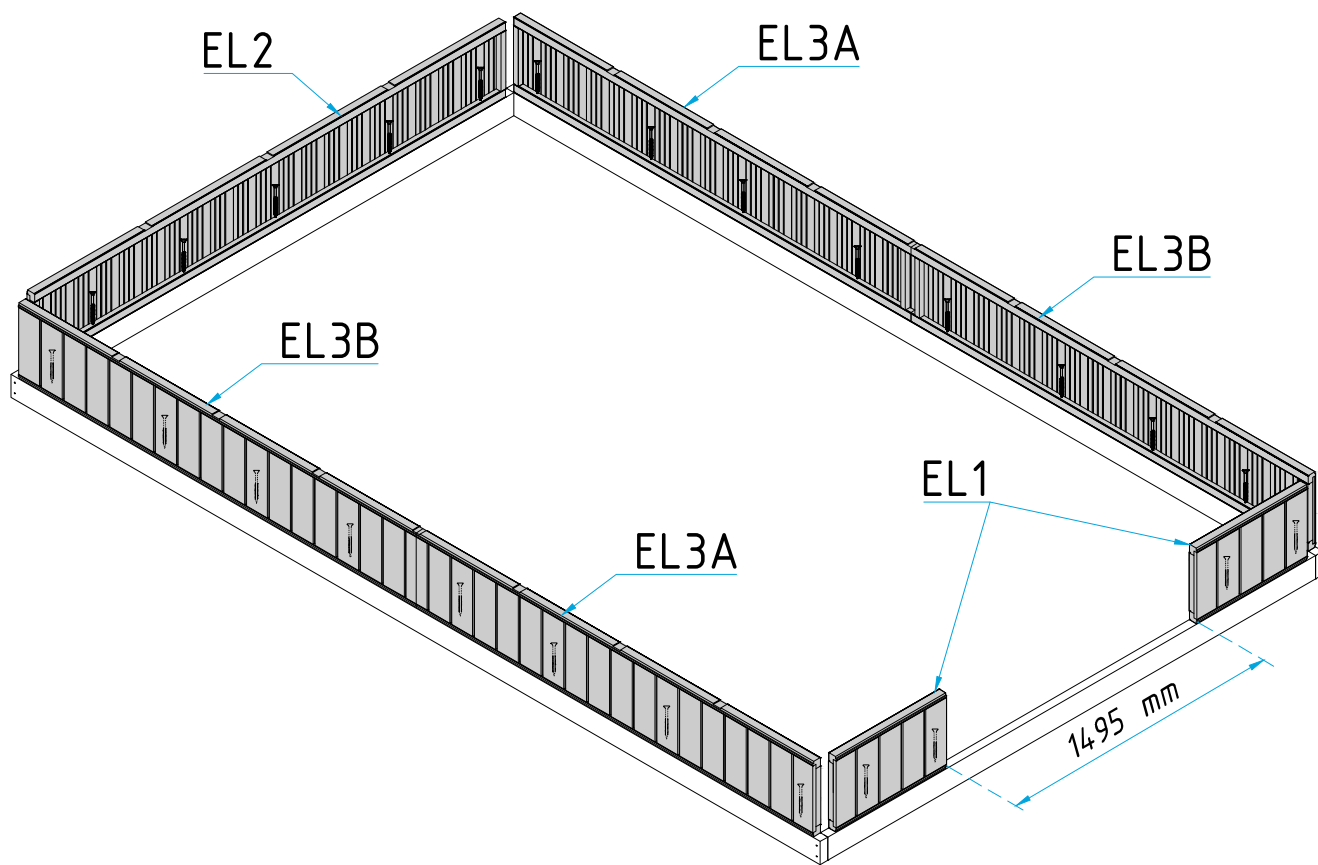

- det 3 - 2 pcs F6 - 16 pcs
- det 4 - 2 pcs F7 - 48 pcs
- det 6 - 2 pcs
- det 7 - 2 pcs
- det 33 - 4 pcs

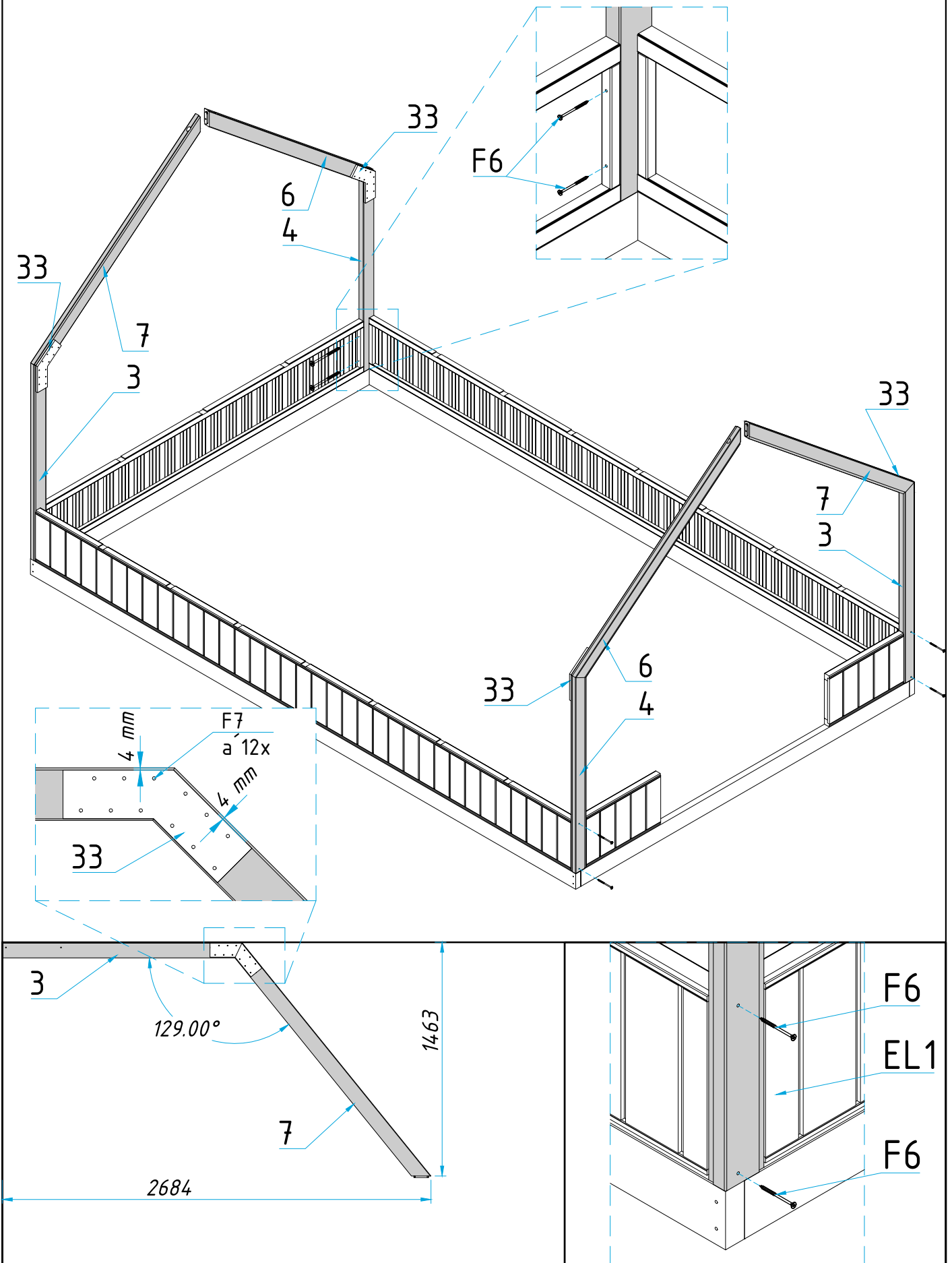

det 16 - 1 pcs

F11 - 2 pcs

F12 - 2 pcs

F13- 4 pcs

4

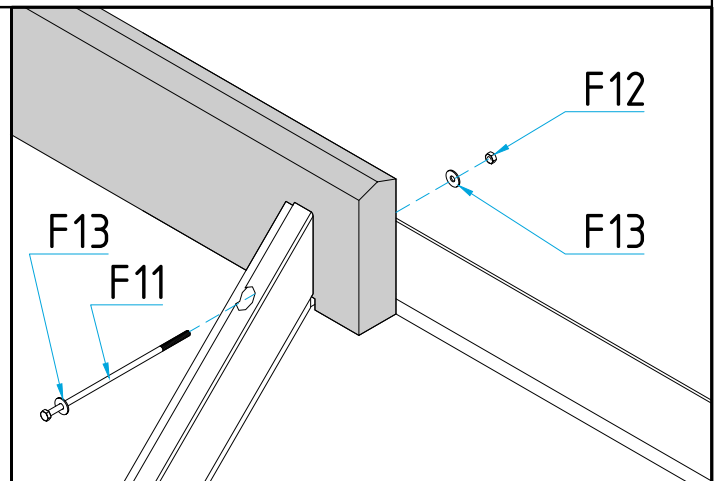
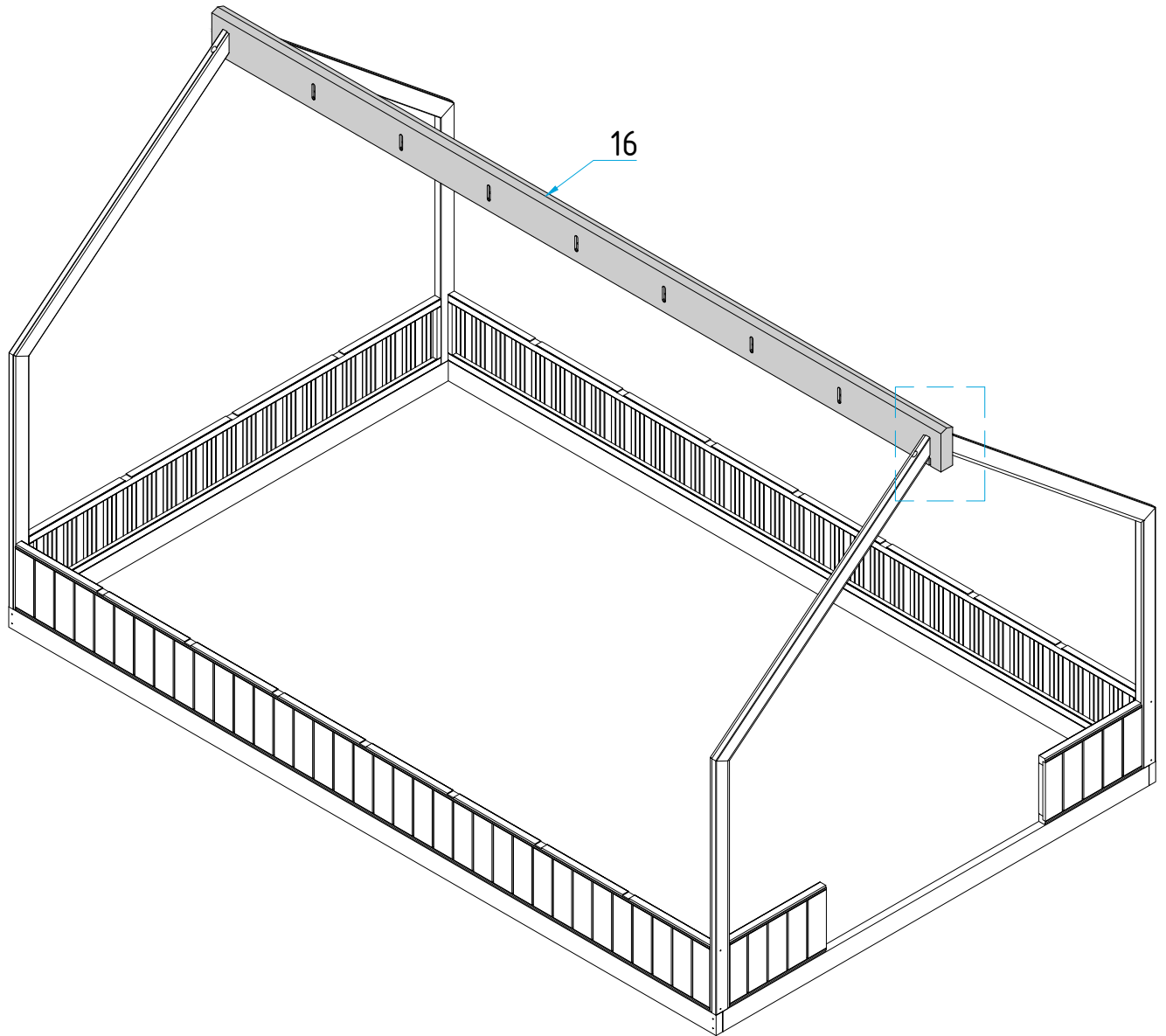

- det 10 - 3 pcs
- det 11 - 1 pcs
- det 12 - 1 pcs
- det 13 - 1 pcs
- det 14 - 1 pcs
- det 15 - 2 pcs

F6 - 34 pcs

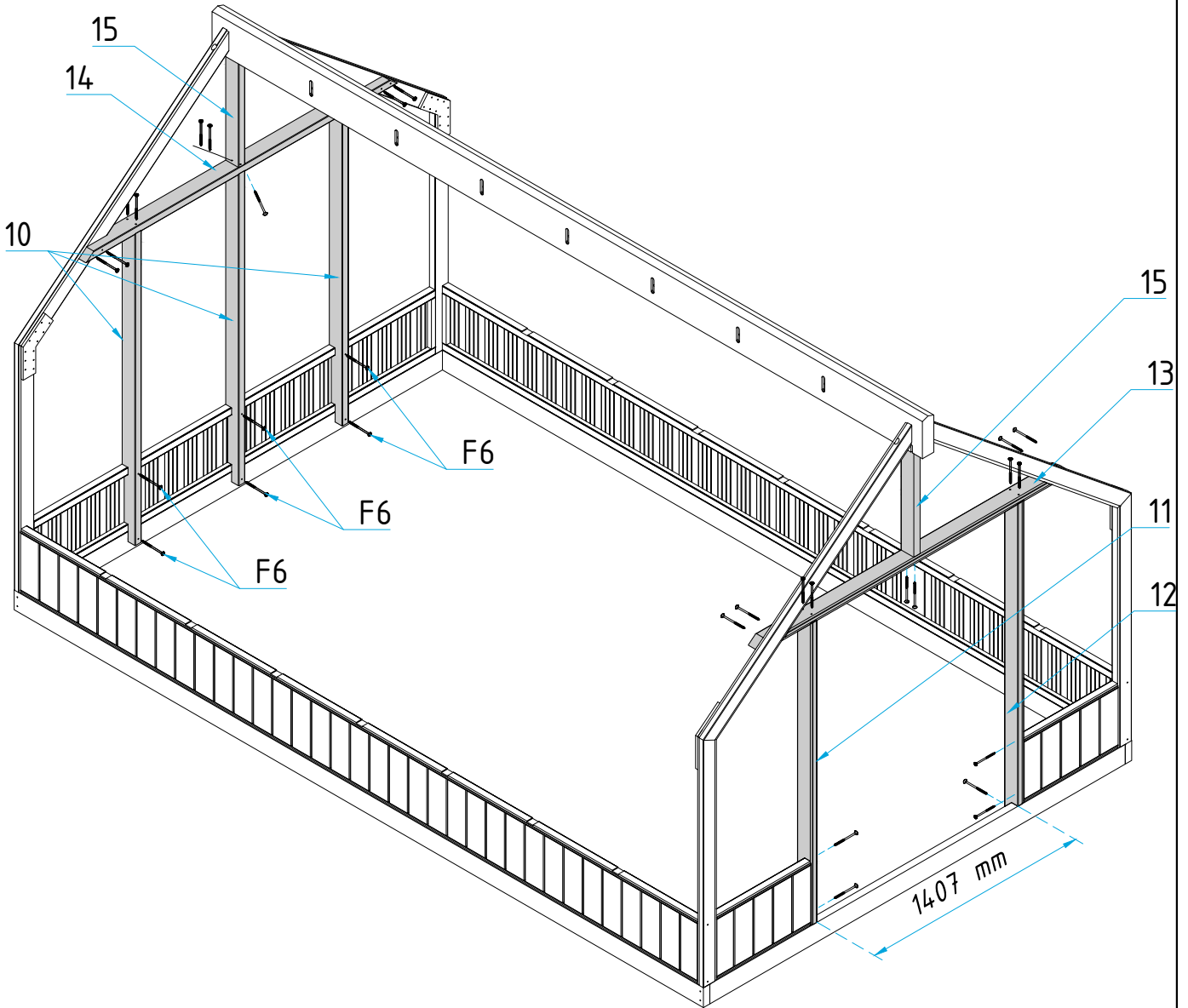

- det 5 - 14 pcs
- det 8 - 2 pcs
- det 9 - 14 pcs
- det 33 - 28 pcs
- det 26 - 4 pcs
- F6 - 36 pcs
- F7- 356 pcs
- F8- 8 pcs
- F11 - 7 pcs
- F12 - 7 pcs
- F13- 14 pcs

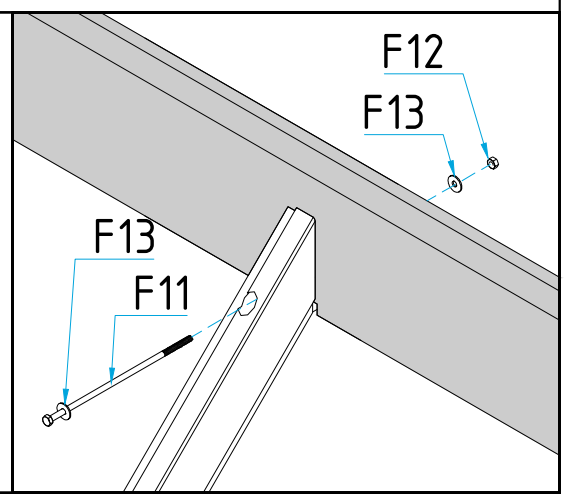
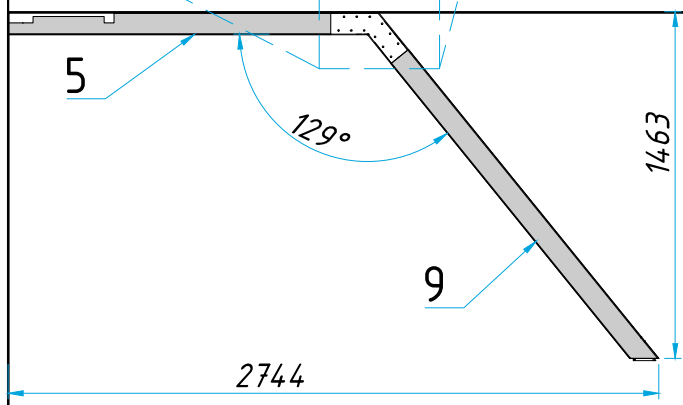
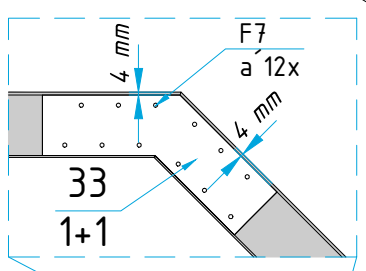
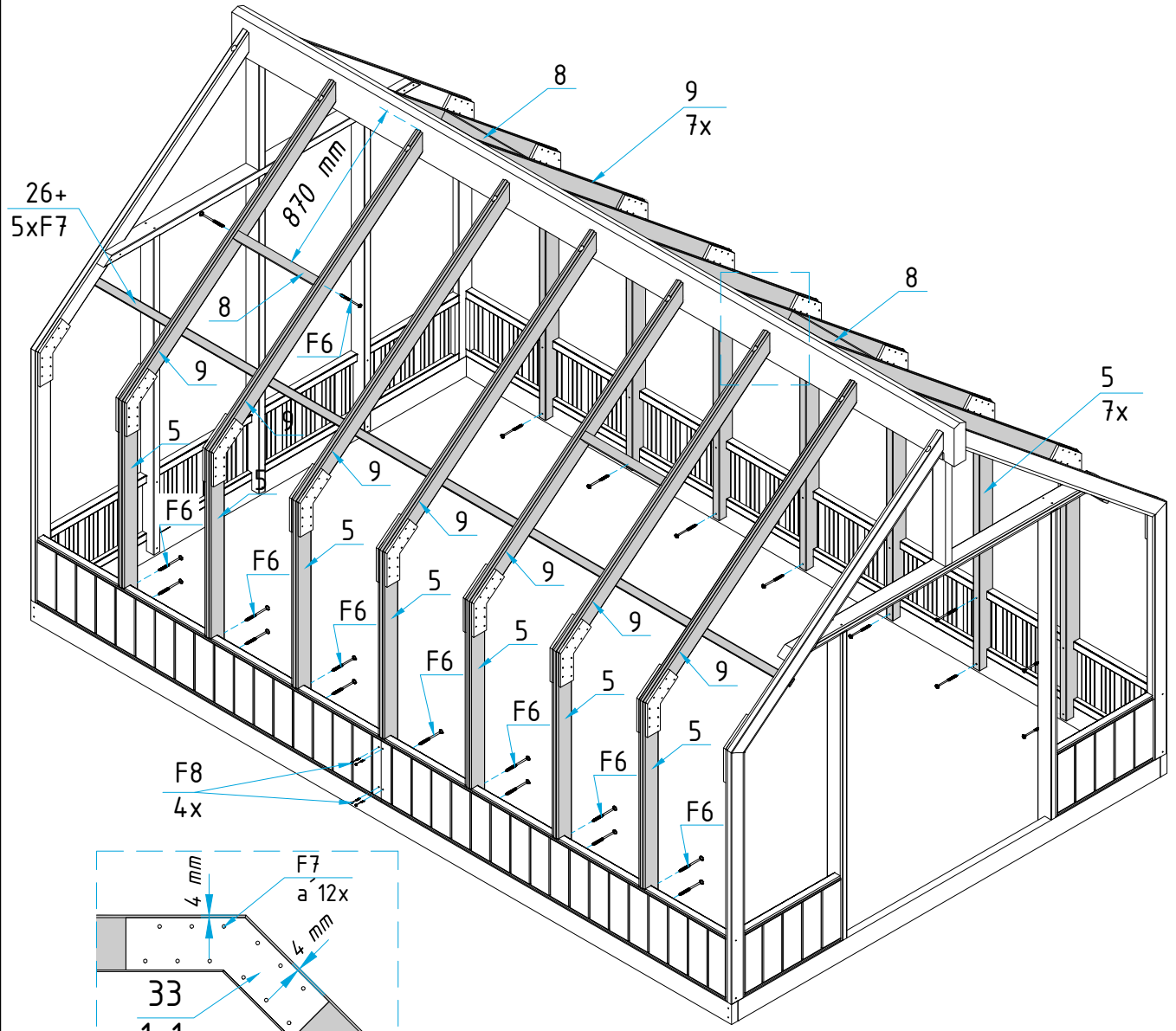

det 101 - 16 pcs

det 20 - 18 pcs

F3 - 18 pcs

F8 - 90 pcs

F20 - 18 pcs 

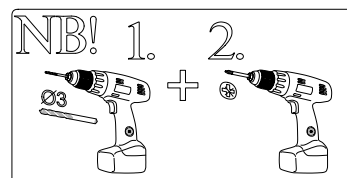

7

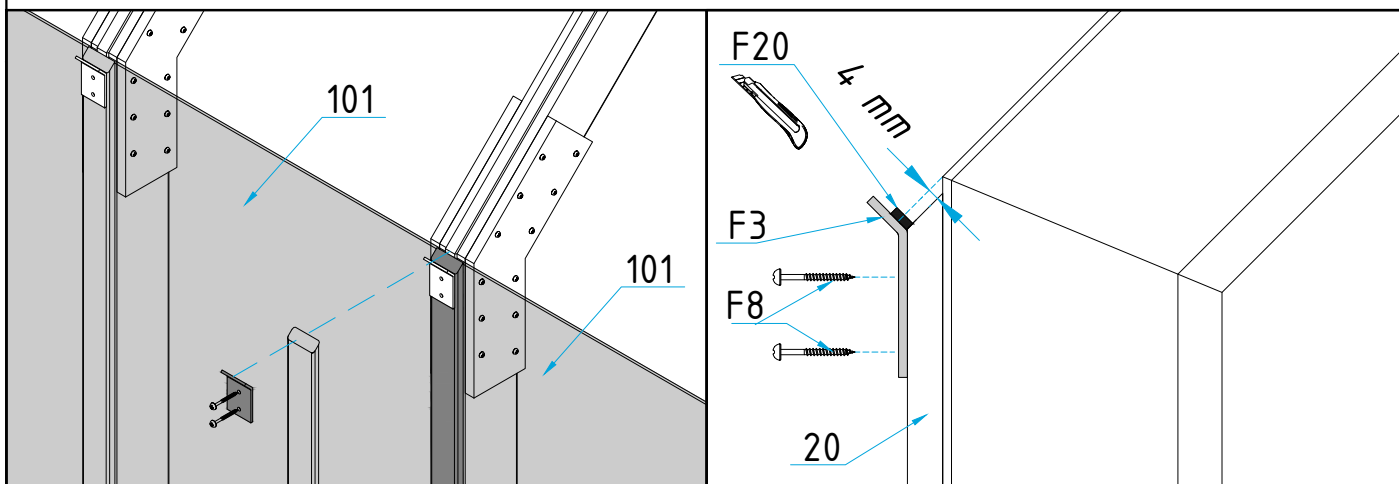
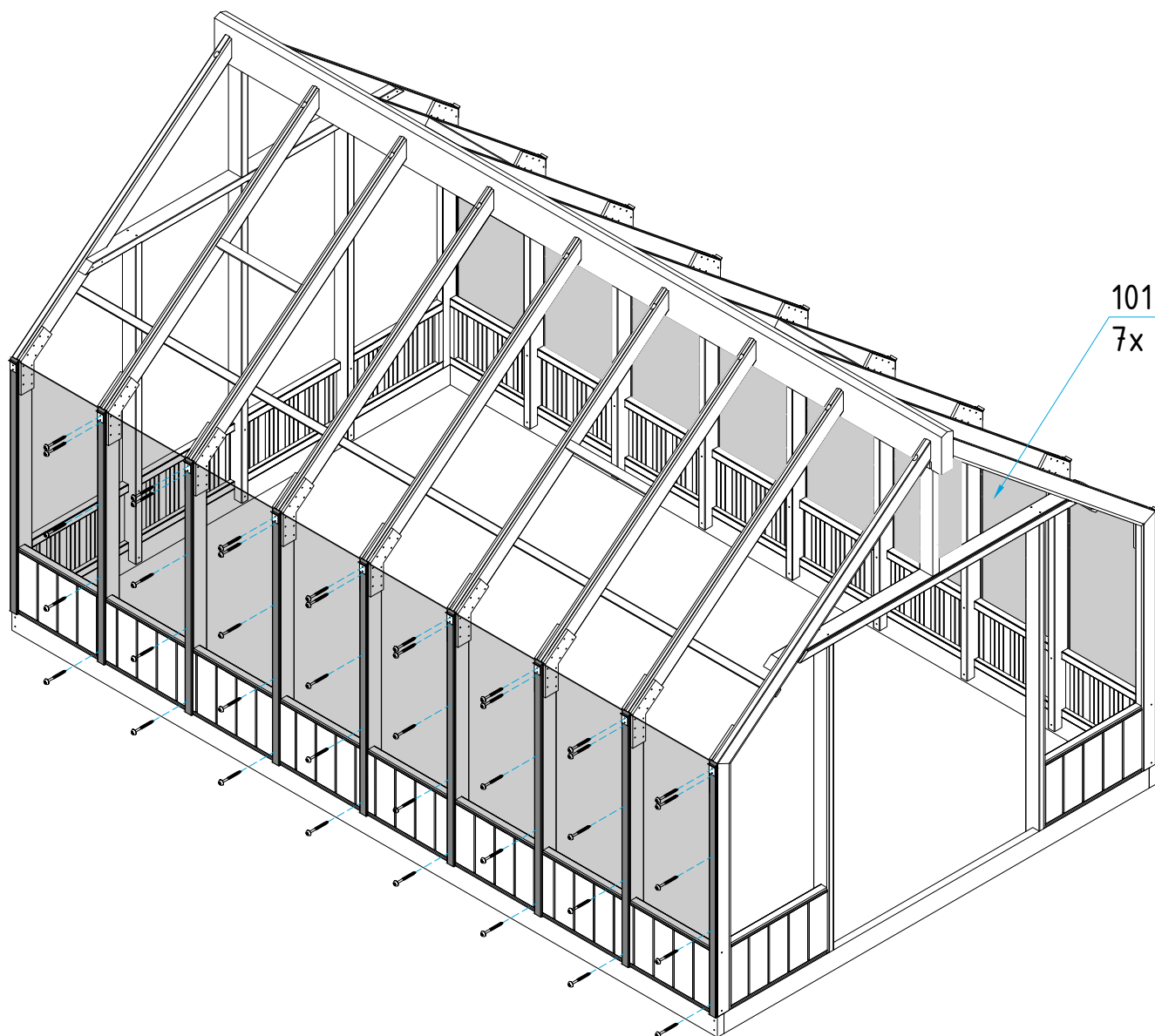

det 102 - 1 pcs
det 103 - 1 pcs
det 24 - 3 pcs
F8 - 15 pcs

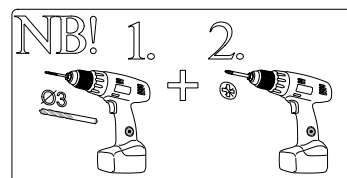

8

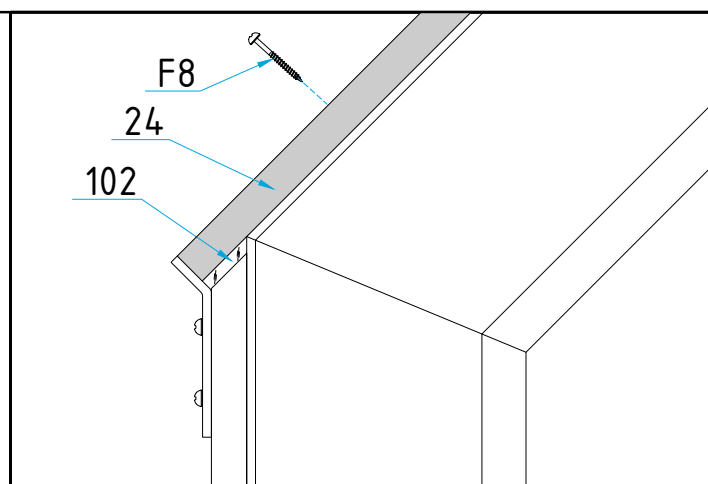
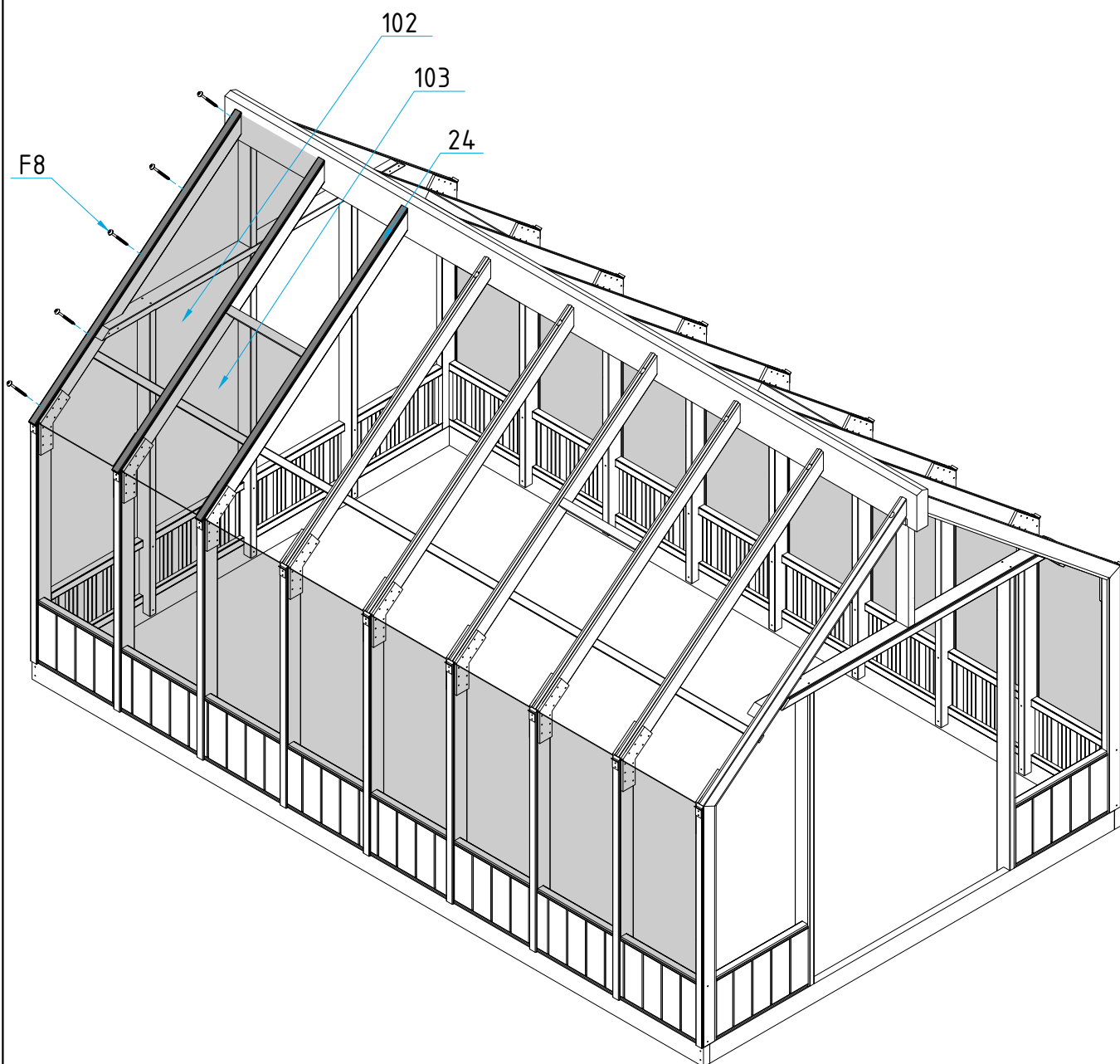

F2

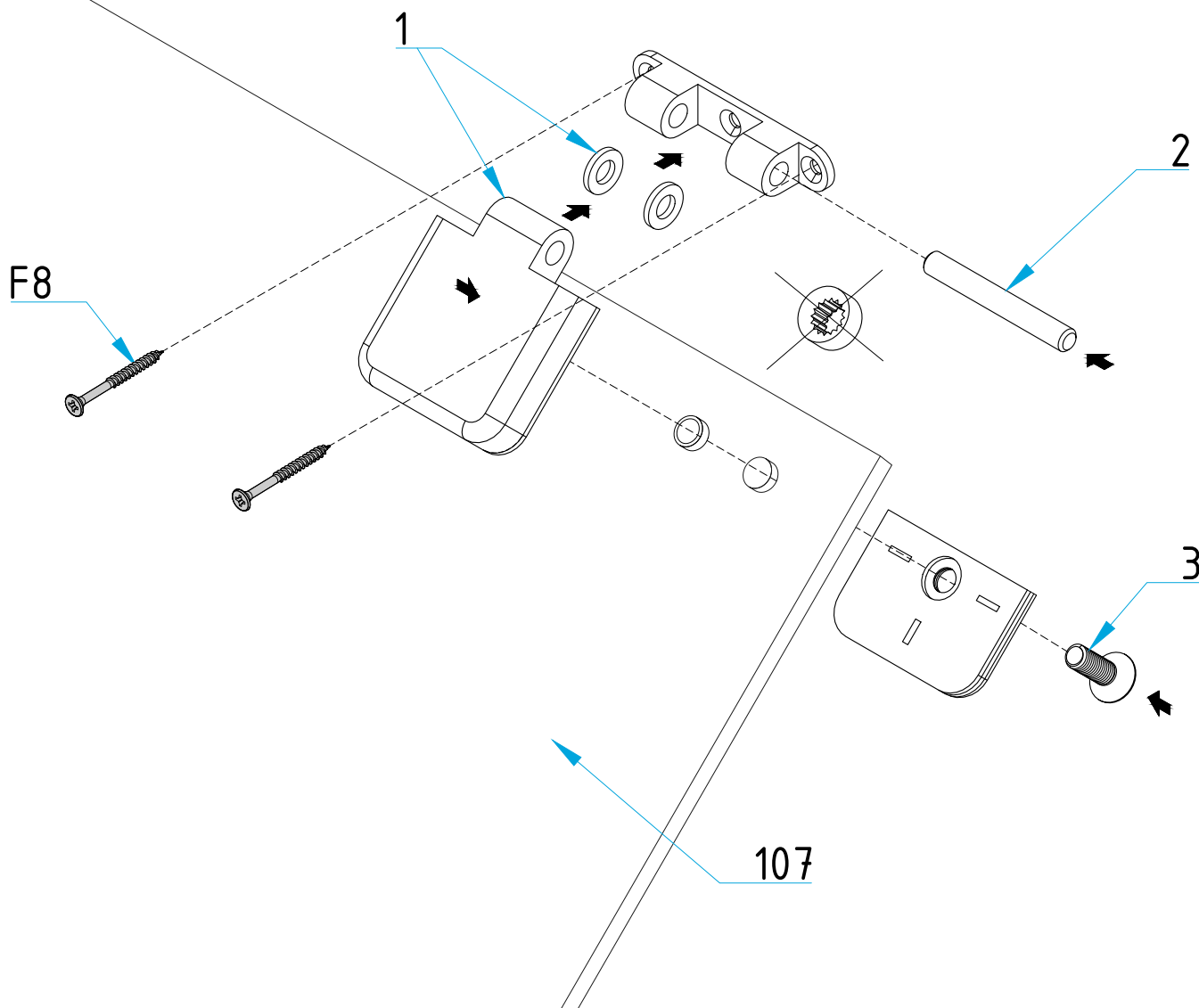

det 107 - 1 pcs

F1 - 1 pcs

F2 - 2 pcs

F8 - 4 pcs

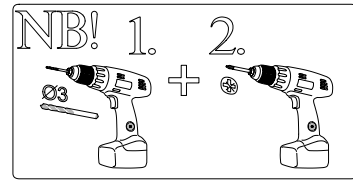

9-2

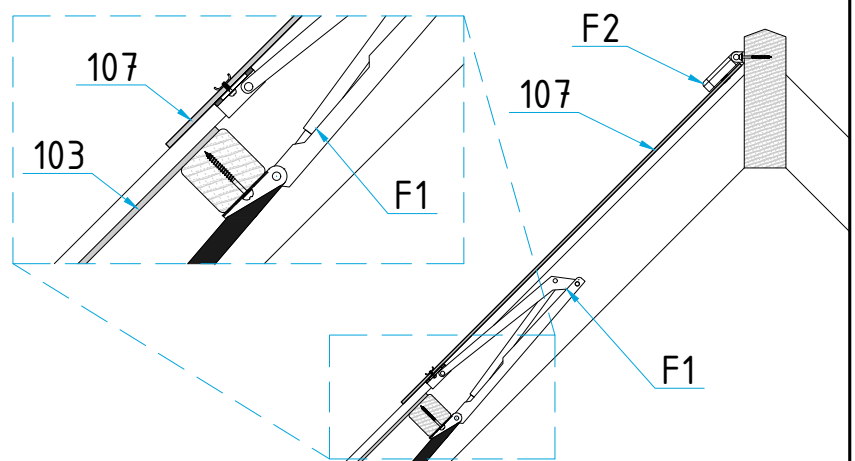
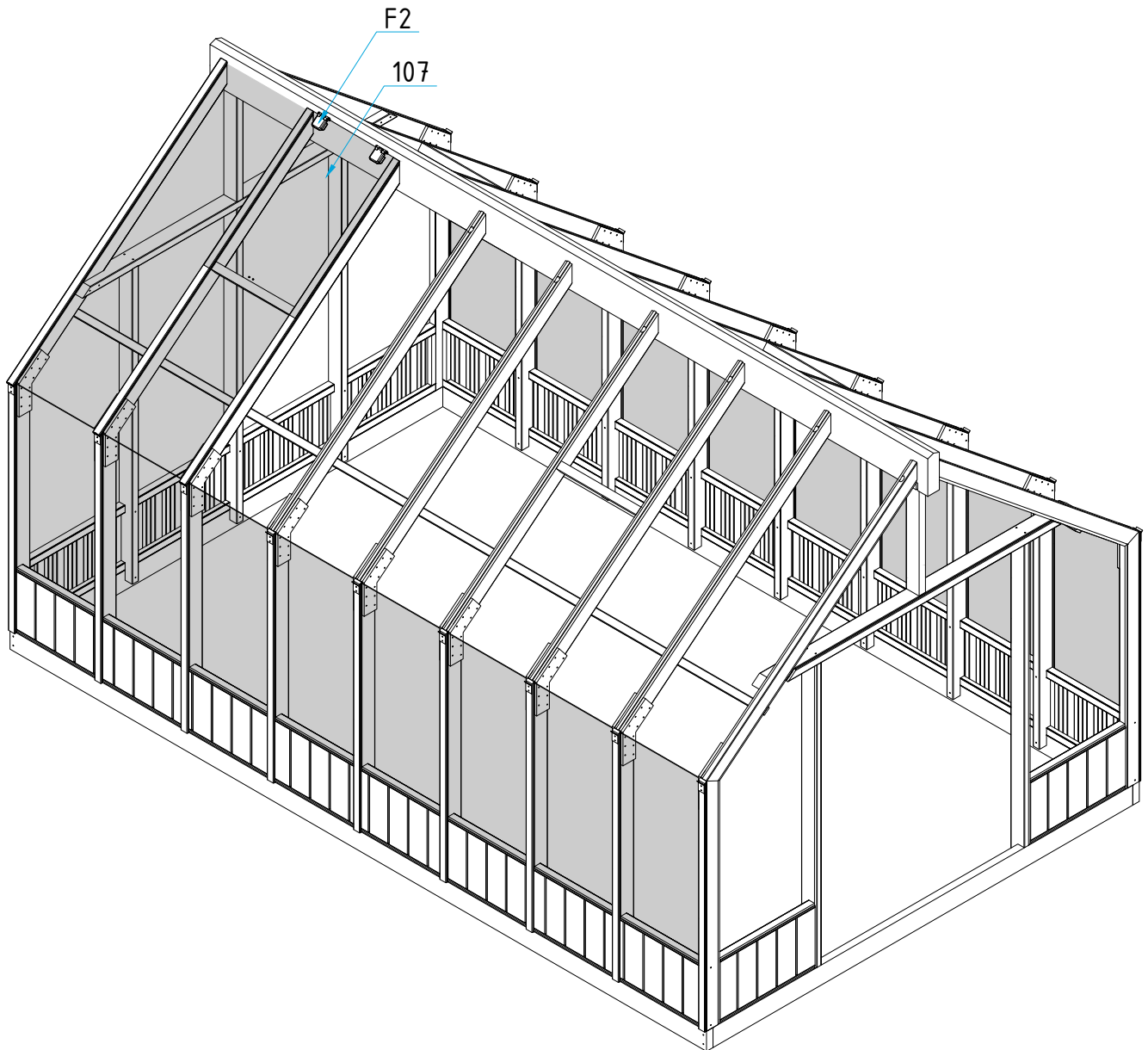

- det 102 - 5 pcs
- det 103 - 1 pcs
- det 107 - 1 pcs
- det 24 - 6 pcs
- F1 - 1 pcs
- F2 - 2 pcs
- F8 - 34 pcs

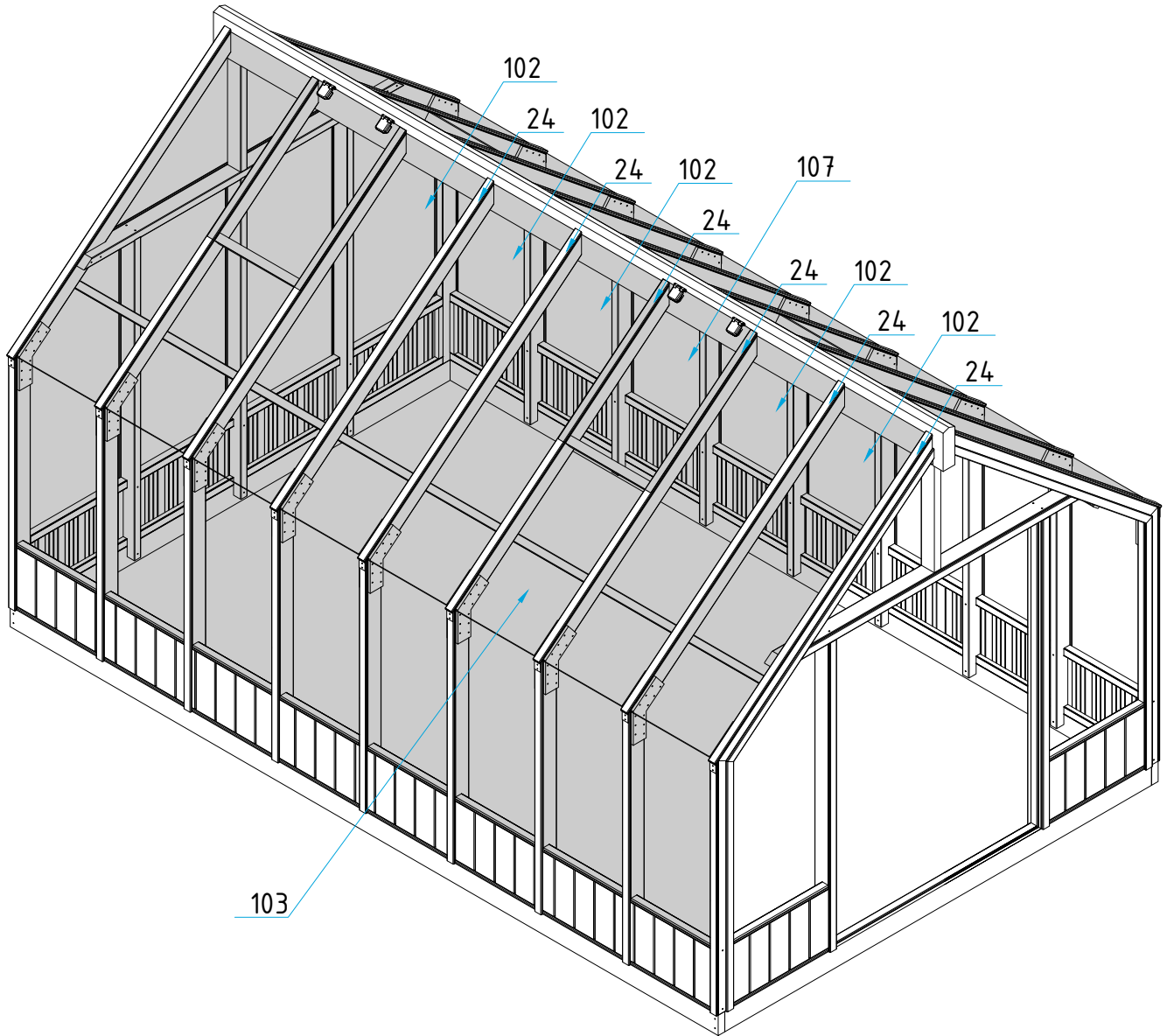
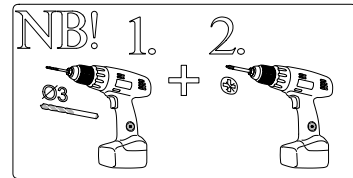

det 104 - 2 pcs
det 105 - 2 pcs
det 106 - 1 pcs
det 21 - 3 pcs
det 22 - 2 pcs
det 23 - 2 pcs
det 25 - 1 pcs

F8 - 40 pcs

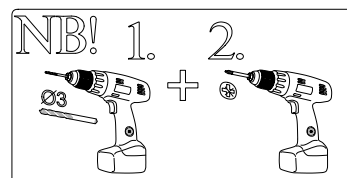

12

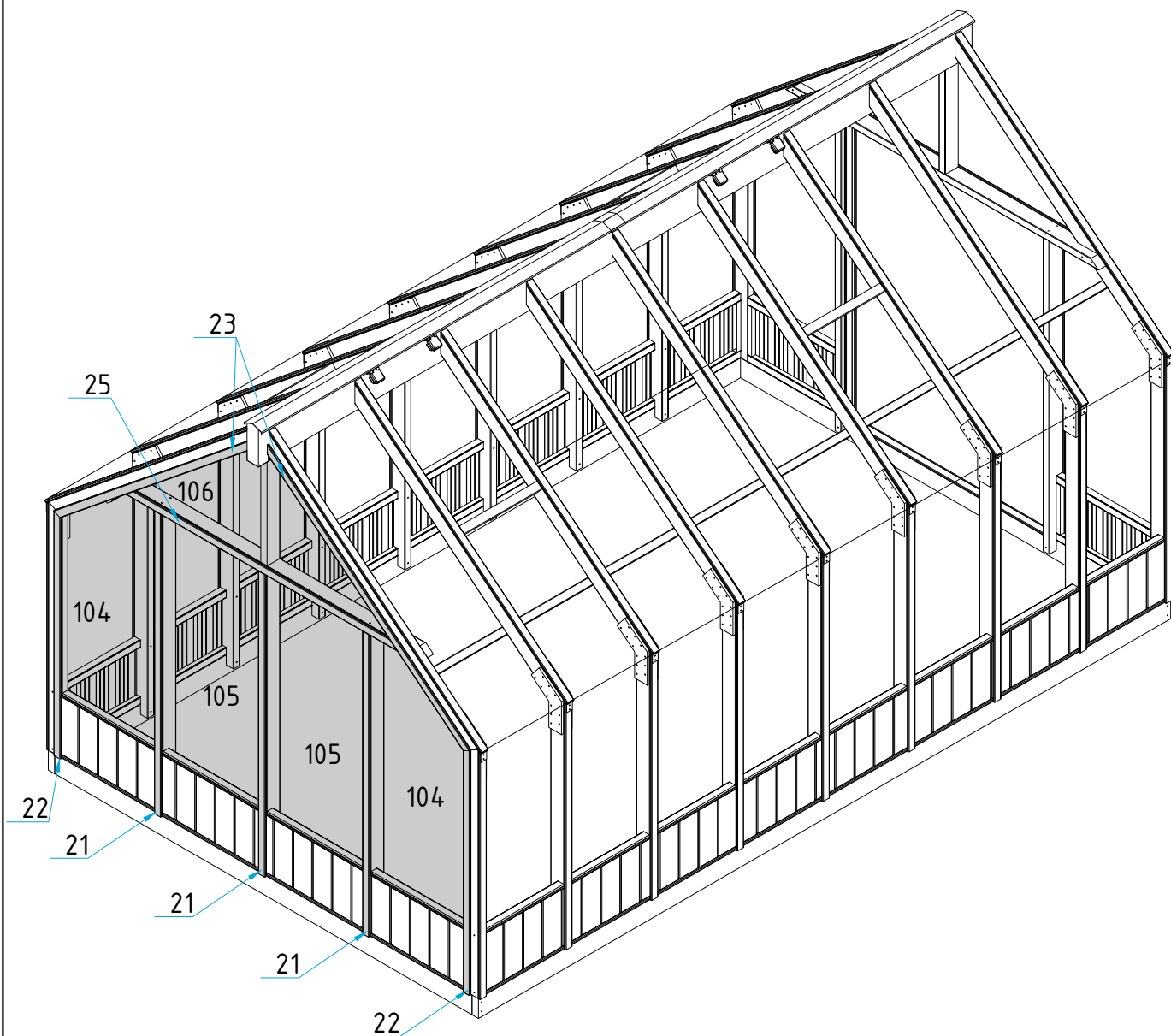

det 104 - 2 pcs
det 106 - 1 pcs
det 21 - 4 pcs
det 22 - 2 pcs
det 23 - 2 pcs
det 25 - 1 pcs
det 27 - 2 pcs

F8 - 55 pcs

13

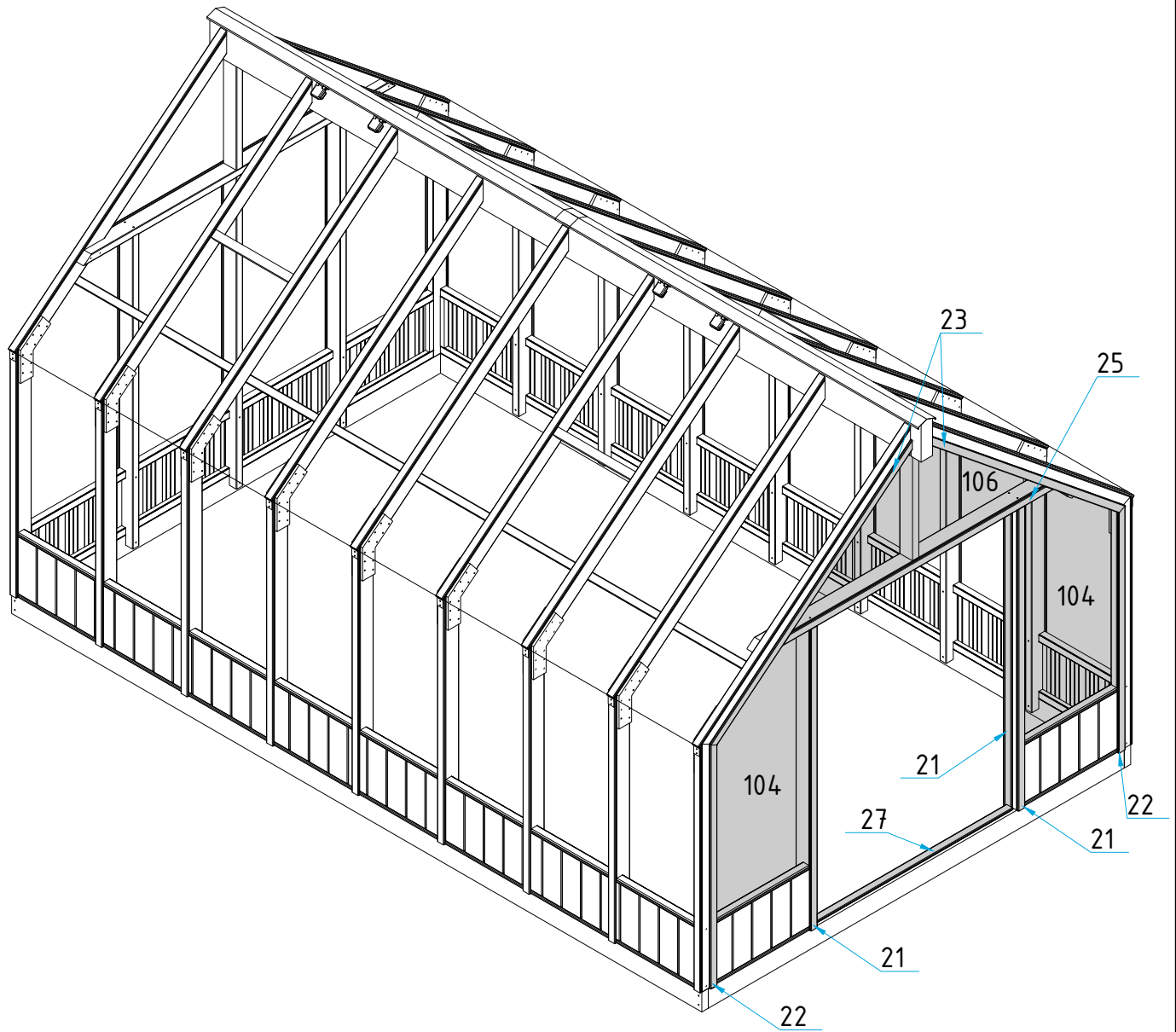

KUL-145 - 1 pcs
KUL-145 - 2 pcs

F4 - 4 pcs
F9 - 12 pcs
F10 - 16 pcs
F16 - 1 pcs
F17 - 1 pcs
F18 - 1 pcs
F19 - 1 pcs
F21 - 2 pcs
F22 - 16 pcs

