

Installation manual

Montageanleitung • Notice de montage • Istruzioni per il montaggio • Manual de montaje • Monteringsanvisning • Installatiegids • Montážní návod • Asennusohje • Installationsmanual • Instrukcja instalacji • Paigaldusjuhend

Log cabin FR28-5330

Blockhaus • Maisonnette en poutres • Casa di travi • Casa de jardin • Anneks • Tuinhuis • Zahradní domek • Timmerstuga • Hirsimökki • Dom z bali • Freesprussmaja

Width 550 x Depth 320 cm











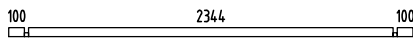
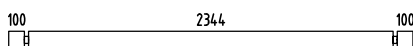
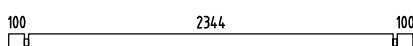

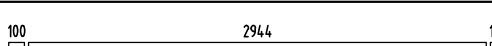
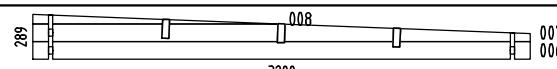
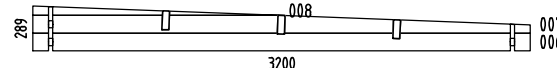
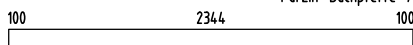

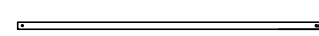
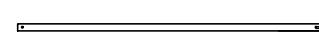

Breite/Tiefe • Largeur/Profondeur • Lunghezza/Profondità • Ancho/Profundidad • Bredde/Dybde • Breedte/Diepte • Šířka/Hloubka • Leveys/Pituus • Bredd/Längd • Szerokość/Głębokość • Laius/pikkus

Log thickness 28 mm

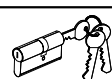
Bohlenstärke • Épaisseur des murs • Spessore delle pareti • Grosor de pared • Tykkelse • Wanddicke • Tloušťka stěny • Seinän paksuus • Väggtjocklek • Grubość ścian • Seinapaksus

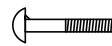

The producer shall have the right to make technical changes to the product • Technische Änderungen vorbehalten • Le producteur réserve le droit d'effectuer des modifications techniques au produit • Il produttore mantiene il diritto di apportare modifiche tecniche al prodotto • Reservado el derecho a modificaciones técnicas • Produsent forbeholder seg retten til å endre tekniske egenskaper ved produktet • Alle rechten en technische wijzigingen voorbehouden • Výrobce si vyhrazuje právo na technické změny výrobku • Valmistaja pidättää oikeuden tehdä tuotteeseen teknisiä muutoksia • Tillverkaren har rätt att utföra tekniska förändringar för produkten • Producent zastrzega sobie prawo do dokonywania zmian technicznych produktu • Tootja jätab endale õiguse muuta toote tehnilisi omadusi

Pos	SPECIFICATION-STÜCKLISTE-NOMENCLATURE-ELEMENTI-ESPECIFICACIÓN FR28-2632	Pcs	Profile (mm)	Length (mm)
001		1	28x57	2600
002		17	28x114	2600
003		2	28x114	2600
004		2	28x57	490
005		32	28x114	490
006		32	28x114	3200
WA-1		1		
WB-1		1		
PR1	 Purlin- Dachpfette- Arbalétrier- Arcareccio- Correa	3	44x140	2600
RB2-1	Roof board- Dachbrett- Madrier du toit- Tavola tetto- Tabla de tejado 	30	89x19	3360
EaE6-1	Eave edging- Dachrandbrett- Madrier en bordure du toit- Tavola bordo tetto- Tabla de valadizo 	2	19x120	2640
FaB7-1	Facia board- Giebelblende- Écran frontal- Schermo frontone- Tabla de facia 	2	19x120	3360
RE2-1	Roof edge reinforcement- Dachrandleiste- Baguette en bordure du toit- Rinforzo bordo tetto- Refuerzo borde tejado 	2	32x40	2600
SiS5-1	Side slat - Randleiste - Baguette en bordure - Llistello bordo 5 	2	28x45	1686
StB1-1	Storm brace- Sturmleiste- Protection contre le vent- Antivento- Protector contra tormentas 	2	25x45	1900
StB1-2	Storm brace- Sturmleiste- Protection contre le vent- Antivento- Protector contra tormentas 	2	25x45	2000
Fim	-Fixing kit- Befestigungsset- Moyens de fixation- Materiale di fissaggio- Kit de fijación 	1	<u>USE</u>	
QPOYP8x60Zn	Bolt -Schloss-schraube -Boulon- Bullone- Perno- M8x60mm PUP0 	8	StB1-1 StB1-2	
QULSI30x35	Cylinder- Zylinderschloss- Serrure a mortaiser- Serratura a cilindro- Bombin- 30.35 	1	TU28-16P	
QLIU KAPal	Door fittings- Türbeschlag- Ferrure- Ferramenta porta- Manilla puerta- QLIUKAPal 	1	TU28-16P	
QRV120	Keeper- Schliessblech- Tole- Lamiera- Aldaba de candado 	1	TU28-16P	
QNA2_2x50Zn	Nail- Nagel- Clou- Chiodo- Clavo- 2.5x50mm 	150	RB2-1	
QMUkk8Zn	Nut- Schraubenmutter- Écrou- Dado- Tuerca- M8mm 	8		
QKRPP2_5x16Zn	Screw- Schraube- Vis- Vite- Tornillo- 2.5x16mm 	2		

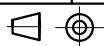

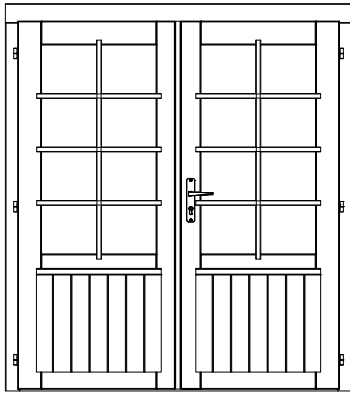
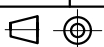
Pos	SPECIFICATION-STÜCKLISTE-NOMENCLATURE-ELEMENTI-ESPECIFICACIÓN FR28-2632	Pcs	Profile (mm)	Length (mm)
QKRPP3x 20Zn	Screw- Schraube- Vis- Vite- Tornillo- 3x20mm			
		16	TU28-16P	
QKRPP4 5x40Zn	Screw- Schraube- Vis- Vite- Tornillo- 4.5x40mm			
		80	FaB7-1 EaE6-1 RE2-1	
QKRPP4 5x70Zn	Screw- Schraube- Vis- Vite- Tornillo- 4.5x70mm			
		15	001;004 SiS5-1	
QKRPP5x 90Zn	Screw- Schraube- Vis- Vite- Tornillo- 5x90mm			
		16	TU28-16P PR1	
QSE8x22 Zn	Washer- Dichtscheibe- Joint- Rondella- Arandela- 8x22mm			
		8		
	Door - Tür - Porte - Porta-Puerta 1610x1822			
		1		
	Object name FRB28-2632			Page 2/2

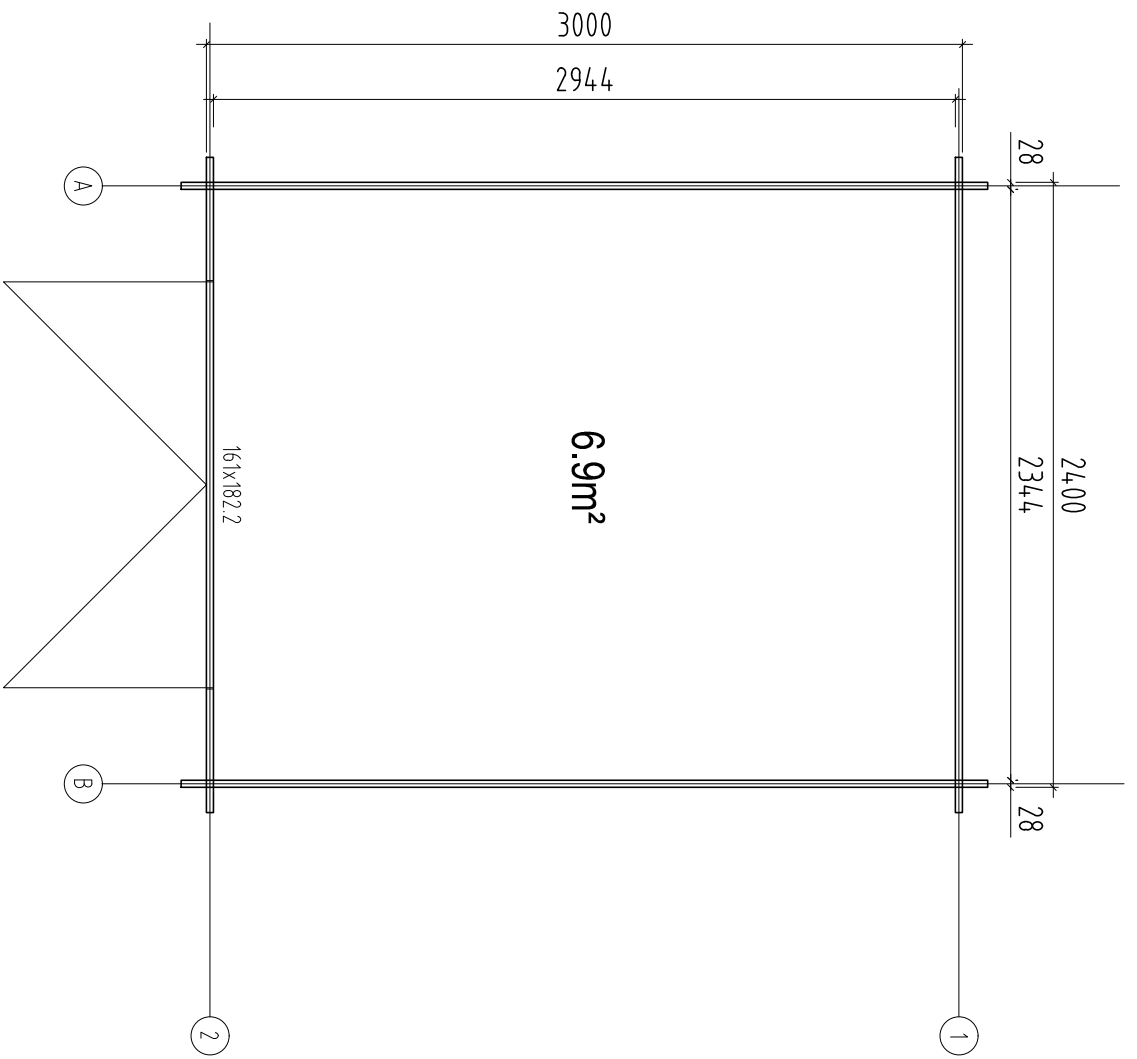

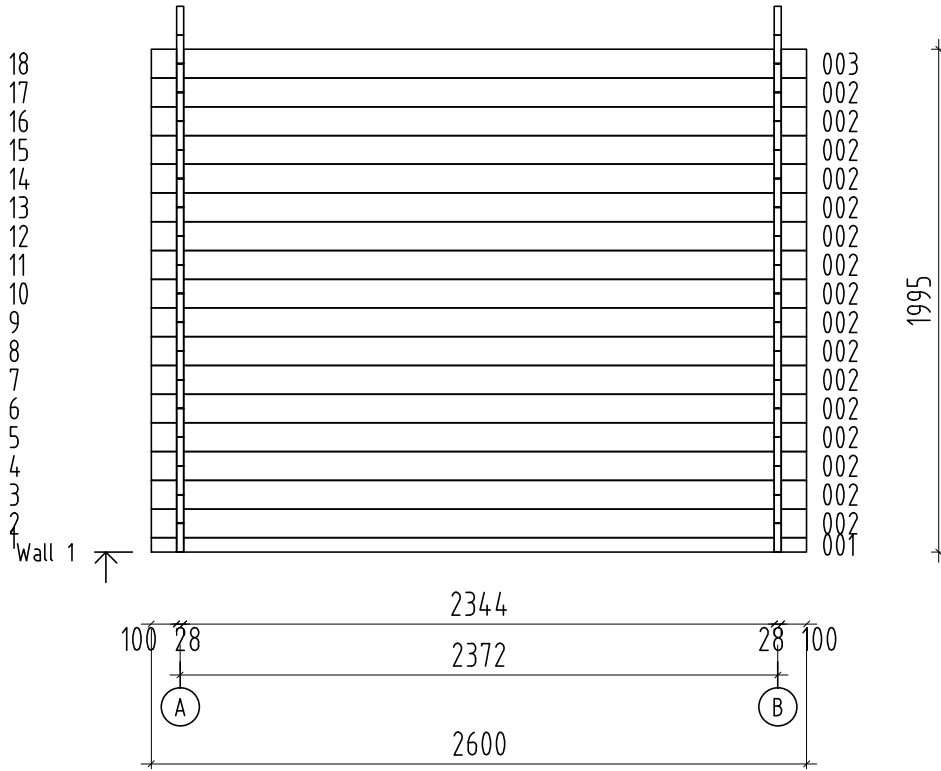

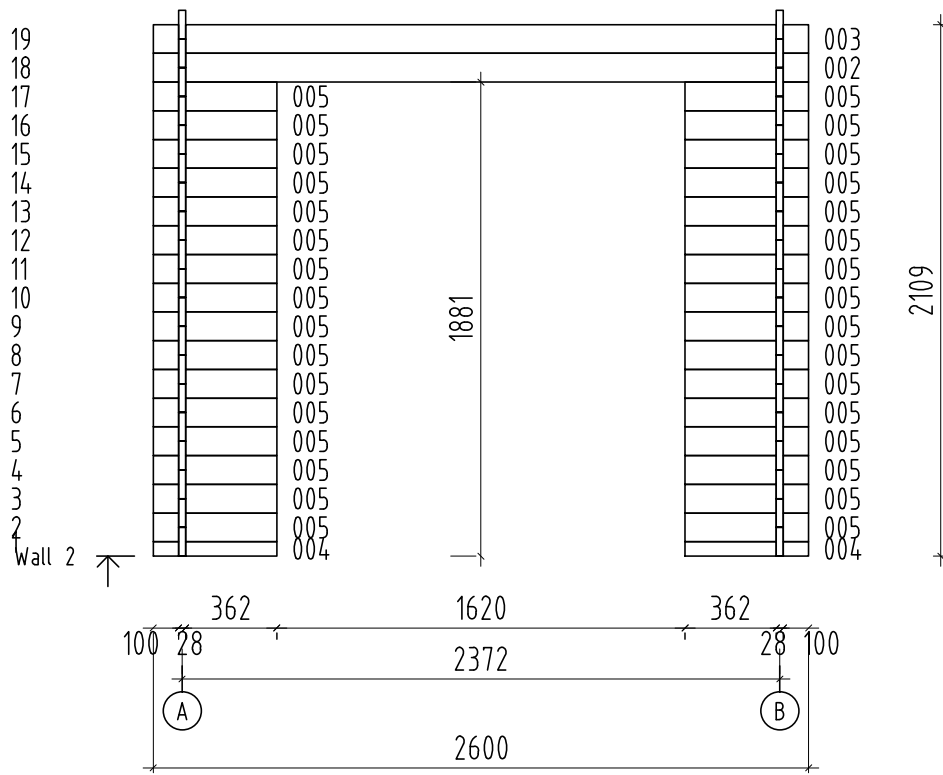

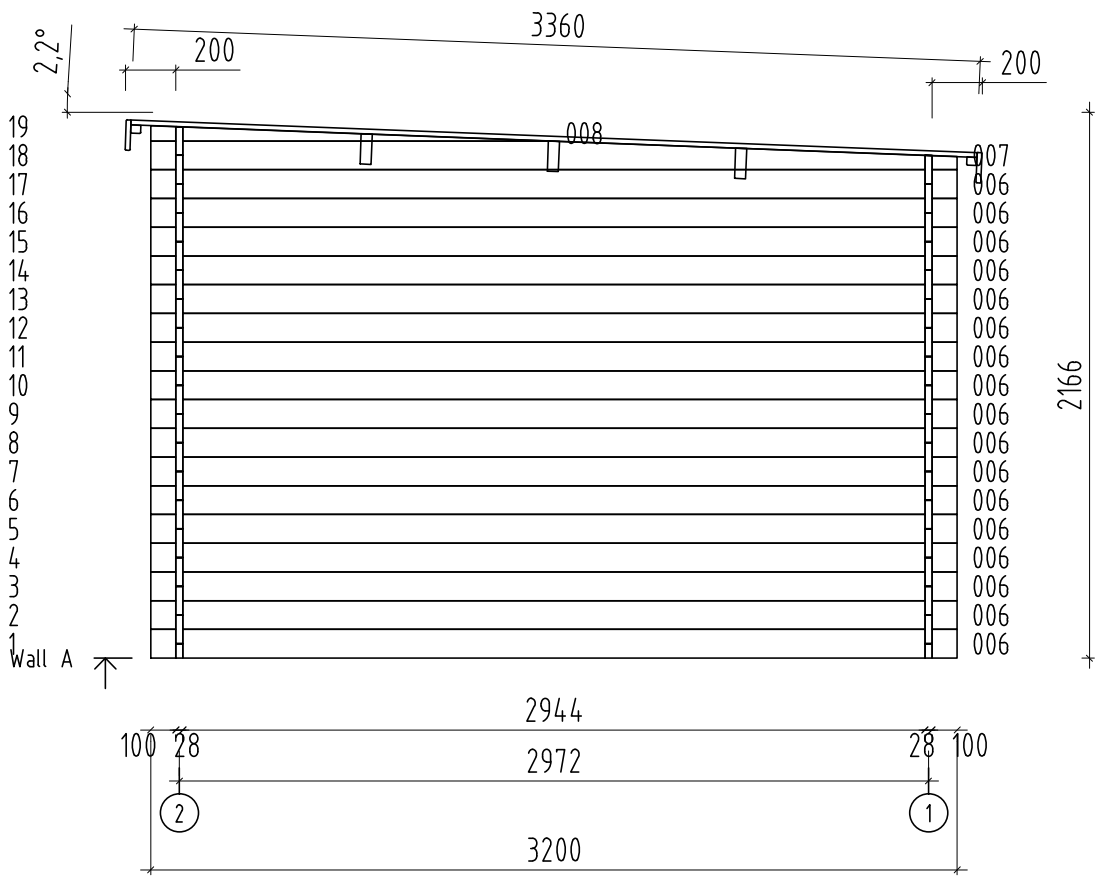

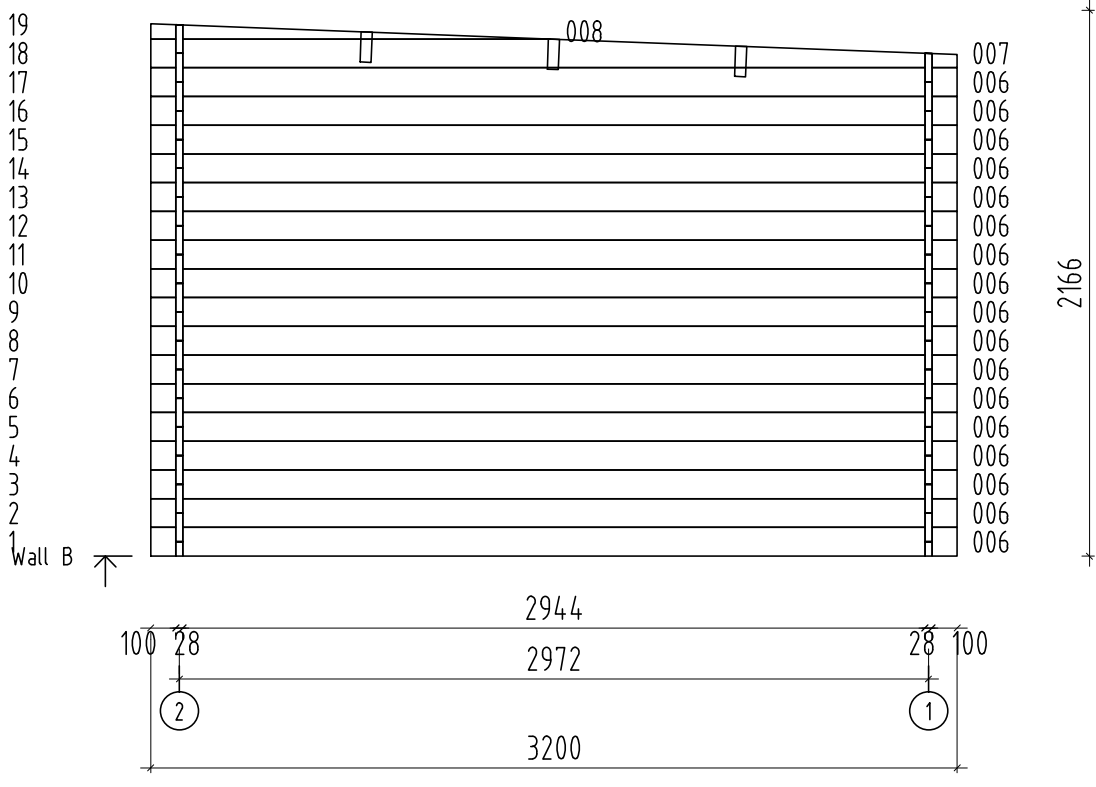

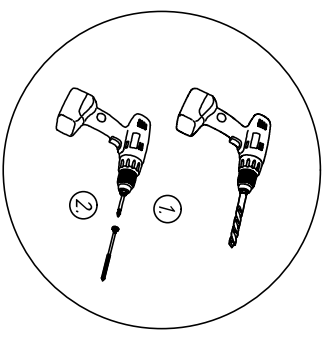
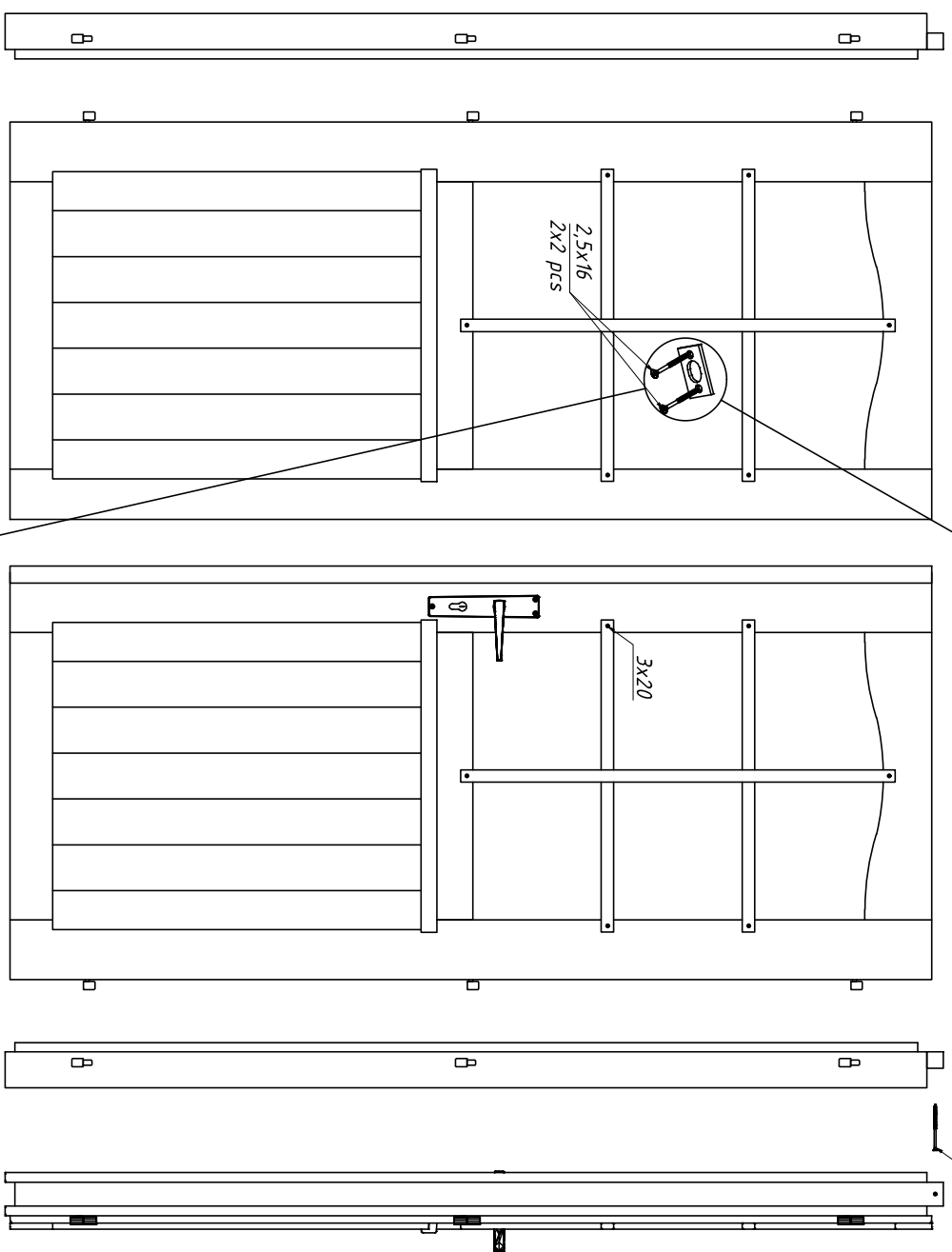
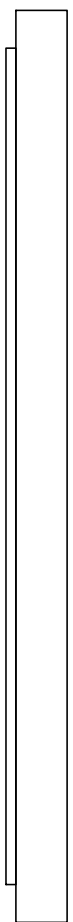
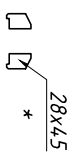
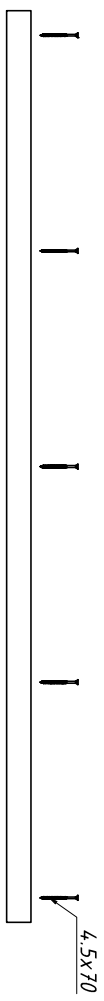



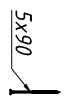

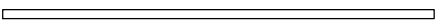
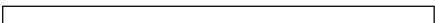

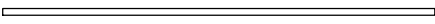

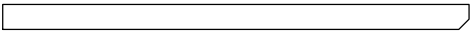
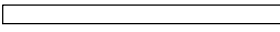
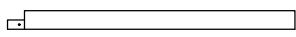
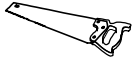
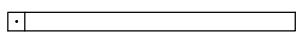
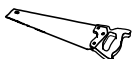
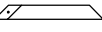
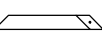

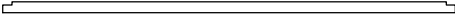





* The specification may vary depending on the specific model
 * Die Spezifikation können je nach Modell unterschiedlich sein
 * Les spécifications peuvent varier selon le modèle spécifique
 * Dependiendo del modelo, la especificación puede cambiar
 * Le specifiche possono variare a seconda del modello

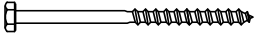
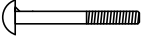
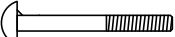
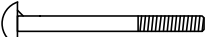

Pos	SPECIFICATION-STÜCKLISTE-NOMENCLATURE-ELEMENTI-ESPECIFICACIÓN LA-2930	Pcs	Profile (mm)	Length (mm)
001		1	28x57	2775
002		15	28x114	2775
003		1	28x68	2775
AR1*	Foundation- Fundament- Fondation- Fondazione- Vigas de cimentación * 	1	70x45	2780
BM1	Beam- Balken- Poutre- Trave- Viga 	1	60x240	2884
BM2	Beam- Balken- Poutre- Trave- Viga 	2	60x160	3000
CoB1	Covering board- Deckbrett- Madrier de couverture- Tavola di copertura- Listón de cubierta 	1	28x120	1790
Pst2	Post- Pfosten- Poteau- Montante- Poste  	1	120x120	1850
Pst1	Post- Pfosten- Poteau- Montante- Poste  	1	120x120	1850
Pst4	Post- Pfosten- Poteau- Montante- Poste 	1	90x90	700
Pst3	Post- Pfosten- Poteau- Montante- Poste 	1	90x90	700
SP1	Support brace- Stützleiste- Baguette de support- Listello di supporto- Listón de soporte 	1	40x32	1790
SP2	Support brace- Stützleiste- Baguette de support- Listello di supporto- Listón de soporte 	1	34x70	2912
PR1	Purlin- Dachpfette- Arbalétrier- Arcareccio- Correa 	3	44x140	2840
PR2	Purlin- Dachpfette- Arbalétrier- Arcareccio- Correa 	3	44x140	100
RB2-1	Roof board- Dachbrett- Madrier du toit- Tavola tetto- Tabla de tejado 	34	89x19	3360
EaE6-1	Eave edging- Dachrandbrett- Madrier en bordure du toit- Tavola bordo tetto- Tabla de valadizo  	2	19x120	3000
FaB7-1	Facia board- Giebelblende- Écran frontal- Schermo frontone- Tabla de facia 	1	19x120	3360
RE2-1	Roof edge reinforcement- Dachrandleiste- Baguette en bordure du toit- Rinforzo bordo tetto- Refuerzo borde tejado  	2	32x40	3000
Fim	-Fixing kit- Befestigungsset- Moyens de fixation- Materiale di fissaggio- Kit de fijación 	1	USE	
QLA80	Adjustment bolt - Senkbolzen - Boulon de réglage - Bullone di regolamento- Perno de ajuste 80-120 	2	Pst	
QKRKK8x160Zn	Bolt -Schloss-schraube -Boulon- Bullone- Perno- 8x160mm KSKR 	2	Pst4 Pst3	
QPOYP8x80Zn	Bolt -Schloss-schraube -Boulon- Bullone- Perno- M8x80mm PUP0 	10	001,002,003 FRB28-2632,FR28-3232-3 SP2	
QPOYP10x100Zn	Bolt -Schloss-schraube -Boulon- Bullone- Perno- M10x100mm PUP0 	10	BM2,PR1 FRB28-2632,FR28-3232-3	
QPOYP10x120Zn	Bolt -Schloss-schraube -Boulon- Bullone- Perno- M10x120mm PUP0 	2	Pst4 Pst3	

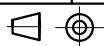

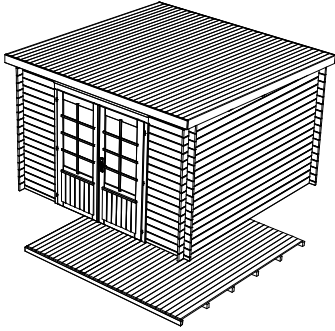

FRB28-2632 ; FRB28-3232-3
+
LAZFB19-3232-4 ; LAZFB19-2632

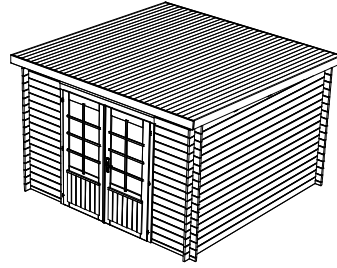
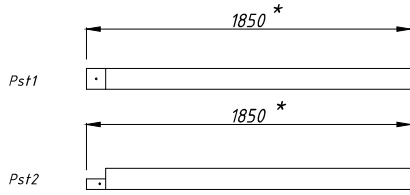

FRB28-2632 ; FRB28-3232-3

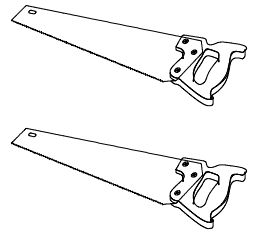
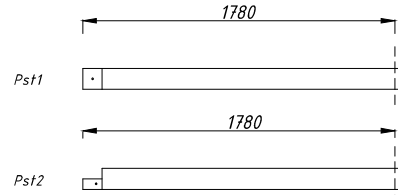

* Model with floor and foundation: LAZFB19-3232-4; LAZFB19-2632

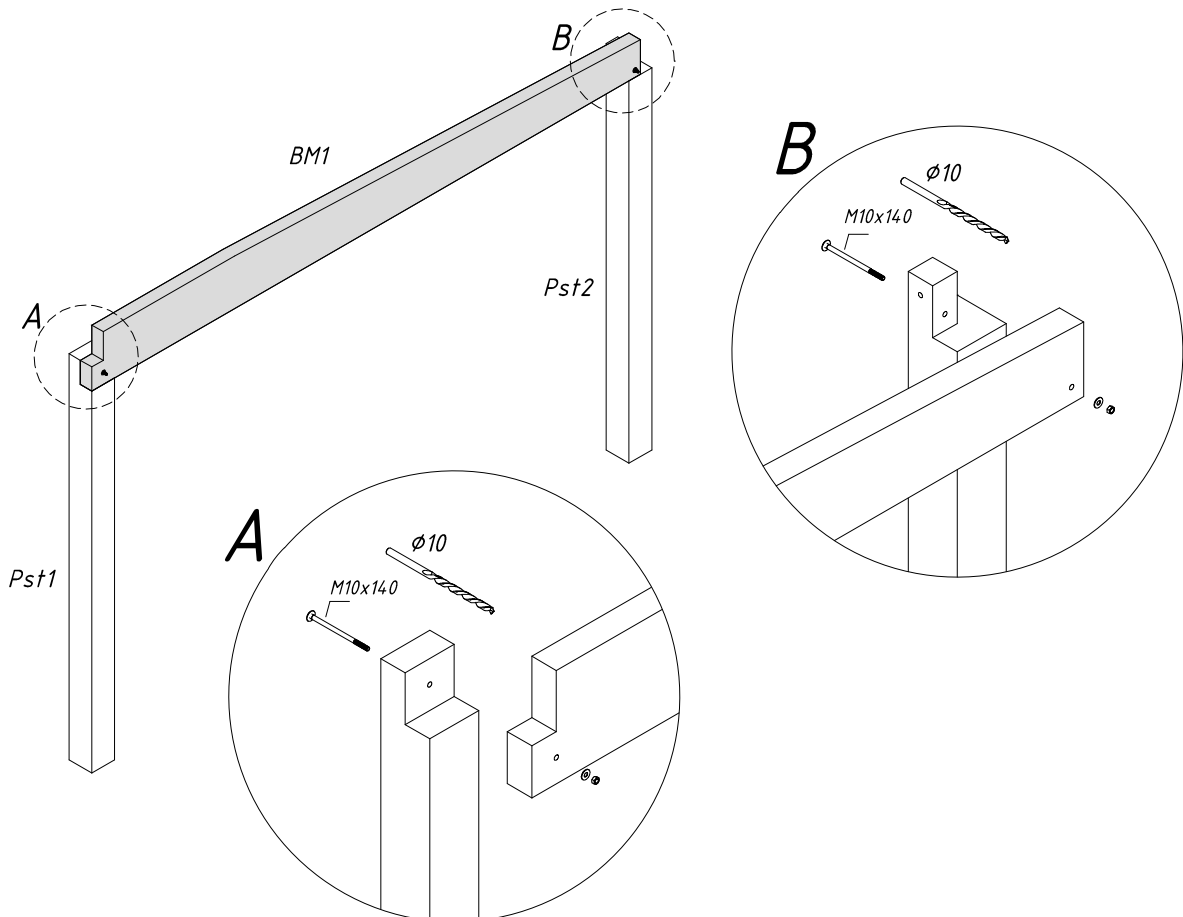

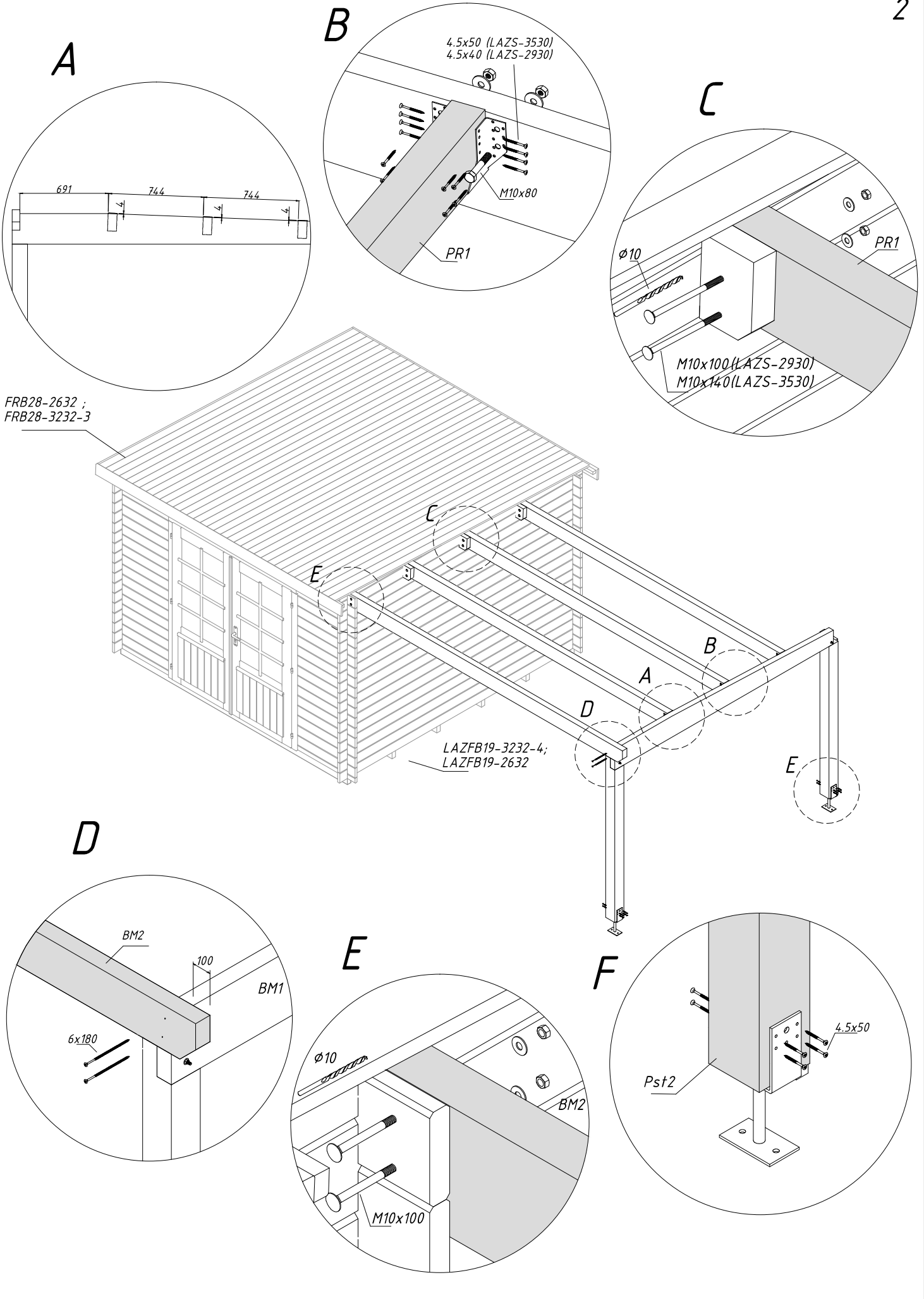

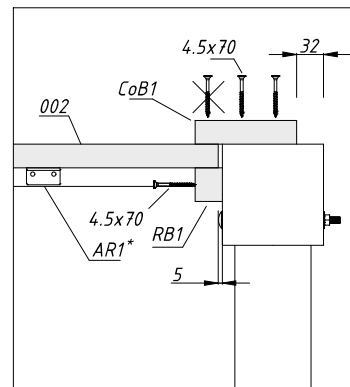
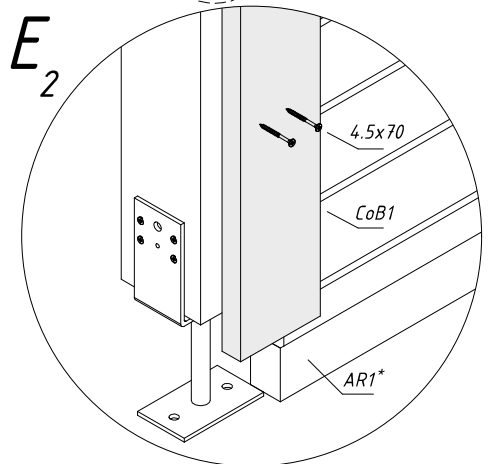
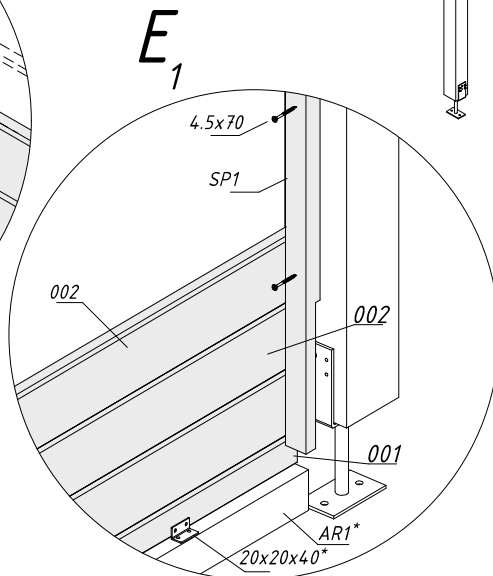
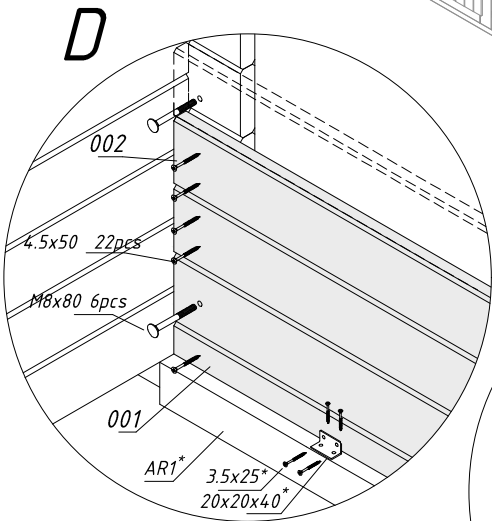
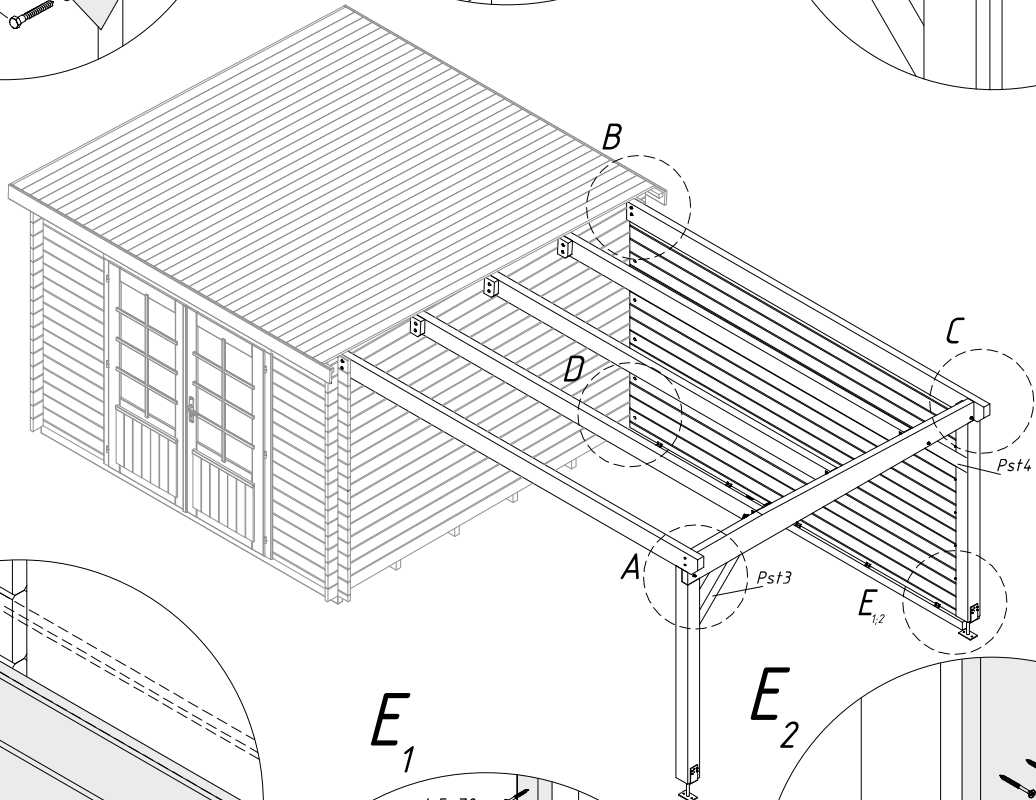
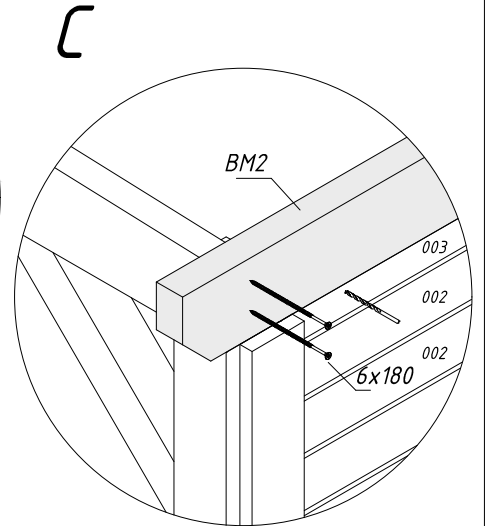
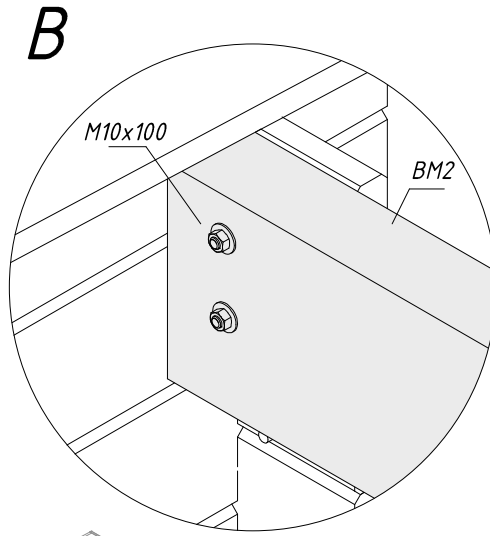
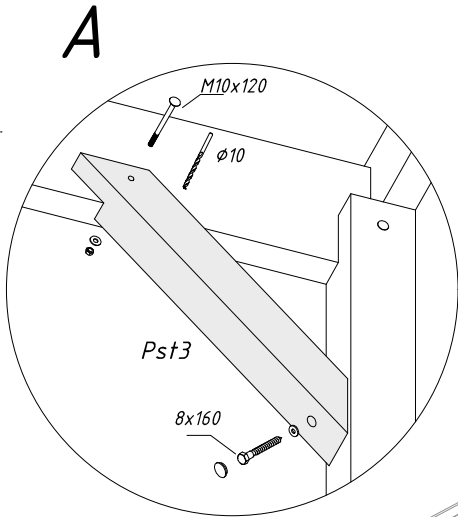

* For model with floor and foundation: LAZFB19-3232-4; LAZFB19-2632

