

# Installation manual

Montageanleitung • Notice de montage • Istruzioni per il montaggio • Manual de montaje • Monteringsanvisning • Installatiegids • Montážní návod • Asennusohje • Installationsmanual • Instrukcja instalacji • Paigaldusjuhend

## Log cabin FR44-4141-1

Blockhaus • Maisonnette en poutres • Casa di travi • Casa de jardin • Anneks • Tuinhuis • Zahradní domek • Timmerstuga • Hirsimökki • Dom z bali • Freesprussmaja

Width 410 x Depth 410cm







Breite/Tiefe • Largeur/Profondeur • Lunghezza/Profondità • Ancho/Profundidad • Bredde/Dybde • Breedte/Diepte • Šířka/Hloubka • Leveys/Pituus • Bredd/Längd • Szerokość/Głębokość • Laius/pikkus

Log thickness 44 mm

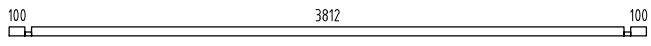
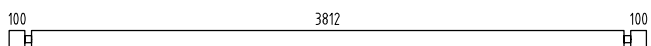
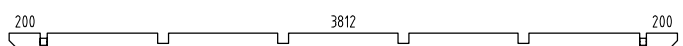
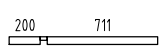
Bohlenstärke • Épaisseur des murs • Spessore delle pareti • Grosor de pared • Tykkelse • Wanddicke • Tloušťka stěny • Seinän paksuus • Väggtjocklek • Grubość ścian • Seinapaksus

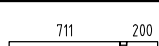
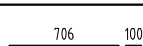
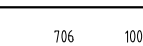
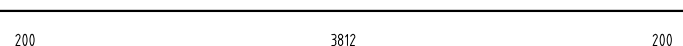
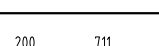
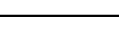
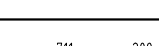
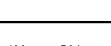

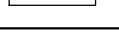
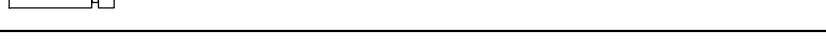
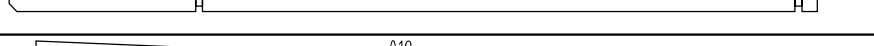
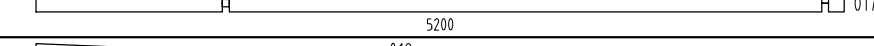
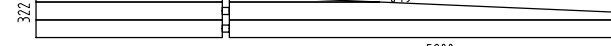
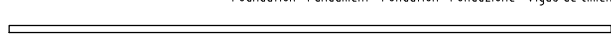
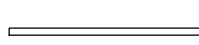
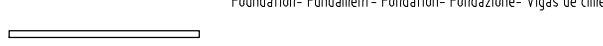

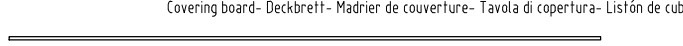
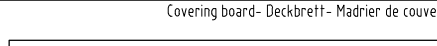

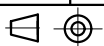



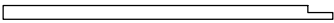





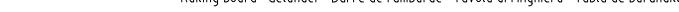

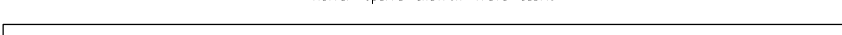





The producer shall have the right to make technical changes to the product • Technische Änderungen vorbehalten • Le producteur réserve le droit d'effectuer des modifications techniques au produit • Il produttore mantiene il diritto di apportare modifiche tecniche al prodotto • Reservado el derecho a modificaciones técnicas • Produsent forbeholder seg retten til å endre tekniske egenskaper ved produktet • Alle rechten en technische wijzigingen voorbehouden • Výrobce si vyhrazuje právo na technické změny výrobku • Valmistaja pidättää oikeuden tehdä tuotteeseen teknisiä muutoksia • Tillverkaren har rätt att utföra tekniska förändringar för produkten • Producent zastrzega sobie prawo do dokonywania zmian technicznych produktu • Tootja jätab endale õiguse muuta toote tehnilisi omadusi











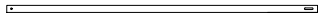

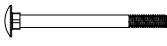
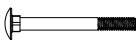
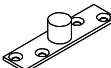
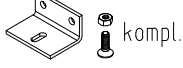

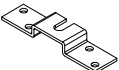

Pos	SPECIFICATION-STÜCKLISTE-NOMENCLATURE-ELEMENTI-ESPECIFICACIÓN FR44-4141-1	Pcs	Profile (mm)	Length (mm)
001		1	44x57	4100
002		41	44x114	4100
003		1	44x114	4300
004		1	44x50	955
005		3	44x50	703
006		1	44x50	955
007		2	44x57	850
008		34	44x114	850
009		1	44x114	4300
010		1	44x100	955
011		3	44x100	703
012		1	44x100	955
013		15	44x114	650
014		30	44x114	555
015		15	44x114	675
016		2	44x114	5200
WA-1		1		
WB-1		1		
AR2	Foundation- Fundament- Fondation- Fondazione- Vigas de cimentación 	2	70x45	3873
AR3	Foundation- Fundament- Fondation- Fondazione- Vigas de cimentación 	11	70x45	3750
AR1	Foundation- Fundament- Fondation- Fondazione- Vigas de cimentación 	2	70x45	1222
CoB2	Covering board- Deckbrett- Madrier de couverture- Tavola di copertura- Listón de cubierta 	1	120x44	3805
CoB3	Covering board- Deckbrett- Madrier de couverture- Tavola di copertura- Listón de cubierta 	1	95x19	3805
CoB1	Covering board- Deckbrett- Madrier de couverture- Tavola di copertura- Listón de cubierta 	2	19x95	4340
CoB4	Covering board- Deckbrett- Madrier de couverture- Tavola di copertura- Listón de cubierta 	2	19x95	2730

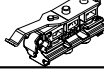
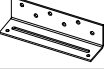

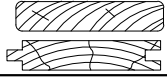
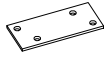

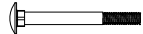

Object name

Pos	SPECIFICATION-STÜCKLISTE-NOMENCLATURE-ELEMENTI-ESPECIFICACIÓN FR44-4141-1		Pcs	Profile (mm)	Length (mm)
CoB5	Covering board- Deckbrett- Madrier de couverture- Tavola di copertura- Listón de cubierta 		2	19x95	2520
Pst1	Post- Pfosten- Poteau- Montante- Poste 		2	90x90	2120
Rai2	Railing board- Geländer- Barre de rambarde- Tavola di ringhiera- Tabla de barandilla 		4	114x19	4340
Rai1	Railing board- Geländer- Barre de rambarde- Tavola di ringhiera- Tabla de barandilla 		4	114x19	4340
Rai6	Railing board- Geländer- Barre de rambarde- Tavola di ringhiera- Tabla de barandilla 		2	114x19	3360
Rai7	Railing board- Geländer- Barre de rambarde- Tavola di ringhiera- Tabla de barandilla 		2	114x19	2810
Rai8	Railing board- Geländer- Barre de rambarde- Tavola di ringhiera- Tabla de barandilla 		2	114x19	2590
Rai5	Railing board- Geländer- Barre de rambarde- Tavola di ringhiera- Tabla de barandilla 		2	114x19	2040
Rai3	Railing board- Geländer- Barre de rambarde- Tavola di ringhiera- Tabla de barandilla 		2	105x19	4340
Rai10	Railing board- Geländer- Barre de rambarde- Tavola di ringhiera- Tabla de barandilla 		2	105x19	3360
Rai9	Railing board- Geländer- Barre de rambarde- Tavola di ringhiera- Tabla de barandilla 		2	105x19	2040
RoR1	Rafter- Sparre- Chevron- Trave- Cabrio 		4	70x140	5410
RoR2	Rafter- Sparre- Chevron- Trave- Cabrio 		8	44x120	200
Sla2	Slat- Leiste- Baguette- Listello- Listón 		3	70x19	509
Sla3	Slat- Leiste- Baguette- Listello- Listón 		4	70x19	500
SP1	Support brace- Stützleiste- Baguette de support- Listello di supporto- Listón de soporte 		8	44x44	330
SP2	Support brace- Stützleiste- Baguette de support- Listello di supporto- Listón de soporte 		20	44x44	300
FB2-1	Floor board- Fussbodenbrett- Madrier du plancher - Tavola pavimento- Tabla de suelo 	43	89x19	3806	
TB1-1	Terrace board- Terrassenbrett- Madrier de terrasse- Tavola terrazzo- Tabla de terraza 	39	95x19	1200	
RB2-1	Roof board- Dachbrett- Madrier du toit- Tavola tetto- Tabla de tejado 	59	89x19	4300	
FIB2-1	Floor beading- Fussbodenleiste- Baguette du plancher- Listello pavimento- Listón de suelo 	7	19x19	1920	
RE2-1	Roof edge reinforcement- Dachrandleiste- Baguette en bordure du toit- Rinforzo bordo tetto- Refuerzo borde tejado 	2	32x40	95	
RE2-2	Roof edge reinforcement- Dachrandleiste- Baguette en bordure du toit- Rinforzo bordo tetto- Refuerzo borde tejado 	2	32x40	1195	
RE2-3	Roof edge reinforcement- Dachrandleiste- Baguette en bordure du toit- Rinforzo bordo tetto- Refuerzo borde tejado 	2	32x40	3810	
Sla11-1	Slat- Leiste- Baguette- Listello- Listón 	1	19x58	2800	

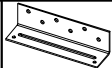
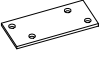
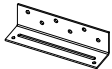

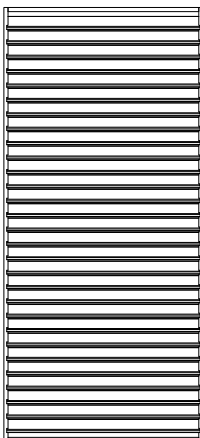



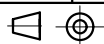



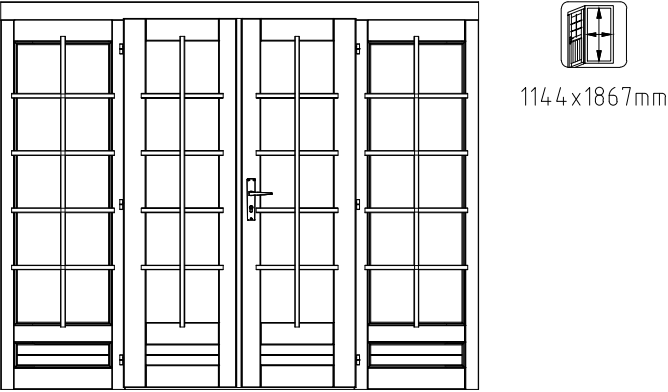

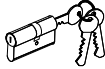
Pos	SPECIFICATION-STÜCKLISTE-NOMENCLATURE-ELEMENTI-ESPECIFICACIÓN FR44-4141-1	Pcs	Profile (mm)	Length (mm)
StB1-1	Storm brace- Sturmleiste- Protection contre le vent- Antivento- Protector contra tormentas 	2	25x45	2200
StB1-2	Storm brace- Sturmleiste- Protection contre le vent- Antivento- Protector contra tormentas 	2	25x45	2300
Fim	-Fixing kit- Befestigungsset- Moyens de fixation- Materiale di fissaggio- Kit de fijación	1	<u>USE</u>	
QLA16	Adjustment bolt - Senkbolzen - Boulon de réglage - Bullone di regolamento- Perno de ajuste 	2	Pst1	
QPOYP8 x100Zn	Bolt -Schloss-schraube -Boulon- Bullone- Perno- M8x100mm PUP0 	2	Pst1	
QPOYP 8x80Zn	Bolt -Schloss-schraube -Boulon- Bullone- Perno- M8x80mm PUP0 	8	StB1-1; StB1-2	
QLY-1	Door fittings- Türbeschlag- Ferrure- Ferramenta porta- Manilla (puerta)- QLY-1 	6	Louvre-2	
QLY-2	Door fittings- Türbeschlag- Ferrure- Ferramenta porta- Manilla (puerta)- QLY-2  kompl.	2	Louvre-2	
QLY-3	Door fittings- Türbeschlag- Ferrure- Ferramenta porta- Manilla (puerta)- QLY-3 	6	Louvre-2	
QLY-4	Door fittings- Türbeschlag- Ferrure- Ferramenta porta- Manilla (puerta)- QLY-4 	6	Louvre-2	
QLY-5	Door fittings- Türbeschlag- Ferrure- Ferramenta porta- Manilla (puerta)- QLY-5  l=3m	2	Louvre-2	
QLY-6	Door fittings- Türbeschlag- Ferrure- Ferramenta porta- Manilla (puerta)- QLY-6  l=3m	2	Louvre-2	
QLY-7	Door fittings- Türbeschlag- Ferrure- Ferramenta porta- Manilla (puerta)- QLY-7 	3	Louvre-2	
QLYFK	Door fittings- Türbeschlag- Ferrure- Ferramenta porta- Manilla (puerta)- QLYFK 	3	Louvre-2	
QNU35x3 5x130Zn	L-iron- Winkel- Angle -Angolo- Angulo 35x35x130 EM VN353590 	6	Louvre-2	
QNA1 4x40Me	Nail- Nagel- Clou- Chiodo- Clavo- 1.4x40mm 	50	FIB2-1	
QNA2 2x50Zn	Nail- Nagel- Clou- Chiodo- Clavo- 2.5x50mm 	900		
QNP25 x60Zn	Nailing plate- Nagelplatte- Connecteur métallique- Piastra connettore- Placa del clavo  57x25x2	7	001;002 007;008	
QMUk K8Zn	Nut- Schraubenmutter- Écrou- Dado- Tuerca- M8mm 	8		
QKRYP4 _5x20Zn	Screw- Schraube- Vis- Vite- Tornillo- 4.5x20mm ZnY 	24	Louvre-2	
QKRP P4_5 X30Zn	Screw- Schraube- Vis- Vite- Tornillo- 4.5x30mm 	24	Louvre-2	
QKRPP4 _5x50Zn	Screw- Schraube- Vis- Vite- Tornillo- 4.5x50mm 	440	Raix+SP1; Raix+SP2 CoBx;RE2-1	
	Object name			Page 3/6

Pos	SPECIFICATION-STÜCKLISTE-NOMENCLATURE-ELEMENTI-ESPECIFICACIÓN FR44-4141-1	Pcs	Profile (mm)	Length (mm)
QKRPP4_5x70Zn	Screw- Schraube- Vis- Vite- Tornillo- 4.5x70mm	20	001;007...	
QKRPP4x16Zn	Screw- Schraube- Vis- Vite- Tornillo- 4x16mm	60		Louvre-2
QKRPP4x25Zn	Screw- Schraube- Vis- Vite- Tornillo- 4x25mm	30		
QKRYP5x40ZnTX	Screw- Schraube- Vis- Vite- Tornillo- 5x40mm	6		
QKRPP5x80ZnTX	Screw- Schraube- Vis- Vite- Tornillo- 5x80mm	80	SP1+RoR1;SP2+RoR2 RoR1+SP2	
QKRPP5x90Zn	Screw- Schraube- Vis- Vite- Tornillo- 5x90mm	34	RoR1+004;005;006 RoR1+010;011;012 004;005;006	
QKRPP6x100Zn	Screw- Schraube- Vis- Vite- Tornillo- 6x100mm	6	CoB2	
QKRPP6x150Zn	Screw- Schraube- Vis- Vite- Tornillo- 6x150mm	38	AR;017;020+RoR2	
QKRPP6x180Zn	Screw- Schraube- Vis- Vite- Tornillo- 6x180mm	8	RoR1	
QSE8x20Zn	Washer- Dichtscheibe- Joint- Rondella- Arandela- 8x20mm	10		
	Louvre-1 900x1960 	2		
	Louvre-2 520x1560 	3		



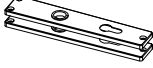

Pos	SPECIFICATION-STÜCKLISTE-NOMENCLATURE-ELEMENTI-ESPECIFICACIÓN FR44-4141-1	Pcs	Profile (mm)	Length (mm)
TU44 -107P	Door - Tür - Porte - Porta-Puerta 2390x1936 	1		
QTI8-1	Seal- Gummidichtung- Joint d'isolation- Guarnizione- Burlete 	1		5500
QULSI 30x35	Cylinder- Zylinderschloss- Serrure a mortaiser- Serratura a cilindro- Bombin- 30.35 	1		
QRV1 20Zn	Keeper- Schliessblech- Tole- Lamiera- Aldaba de candado- 120Zn 	1		
QKRPP2 _5x16Zn	Screw- Schraube- Vis- Vite- Tornillo- 2.5x16mm Zn 	2		
QKRPP 3x20Zn	Screw- Schraube- Vis- Vite- Tornillo- 3x20mm 	40		
QKRPP4 _5x50Zn	Screw- Schraube- Vis- Vite- Tornillo- 4.5x50mm 	12		
QLIU KAPal	Door fittings- Türbeschlag- Ferrure- Ferramenta porta- Manilla puerta- QLIUKAPal 	1		
QULKAK	Door fittings- Türbeschlag- Ferrure- Ferramenta porta- Manilla puerta- QULKAK 	1		
 	Object name			Page 6/6

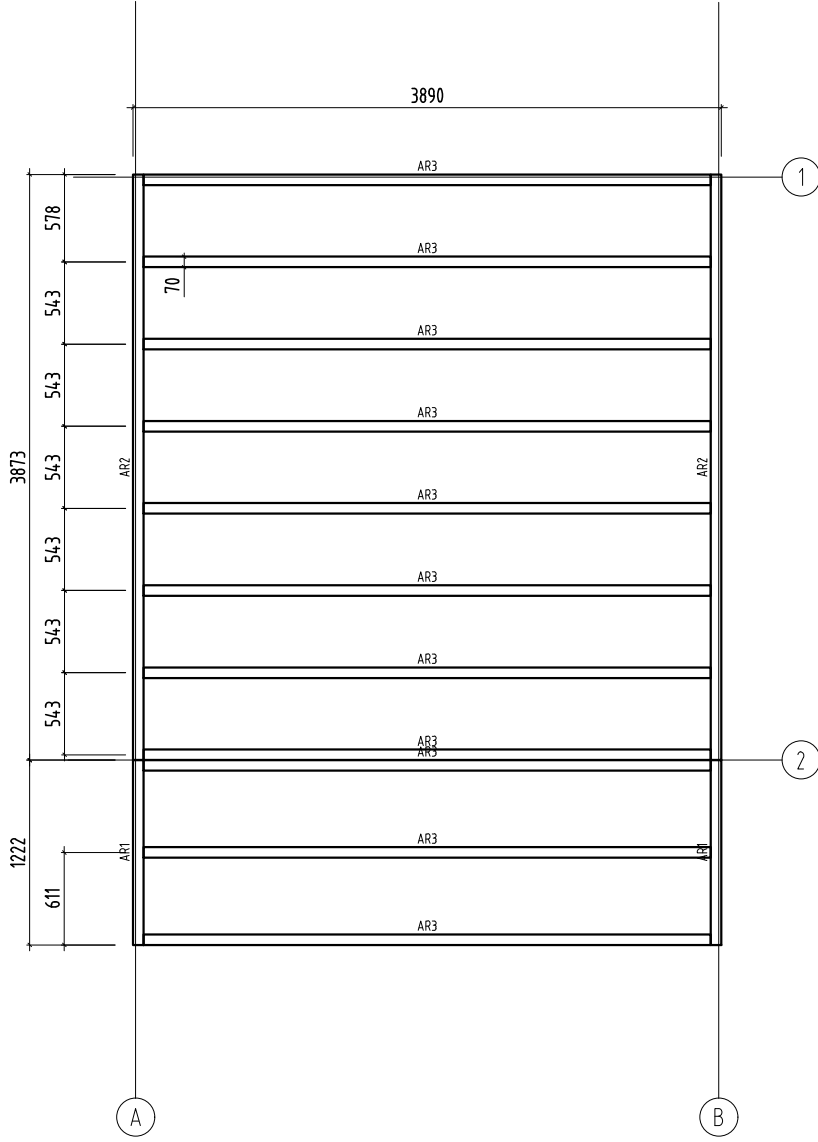



H = 1.500 m  
 TOTAL: 14.53 m<sup>2</sup>

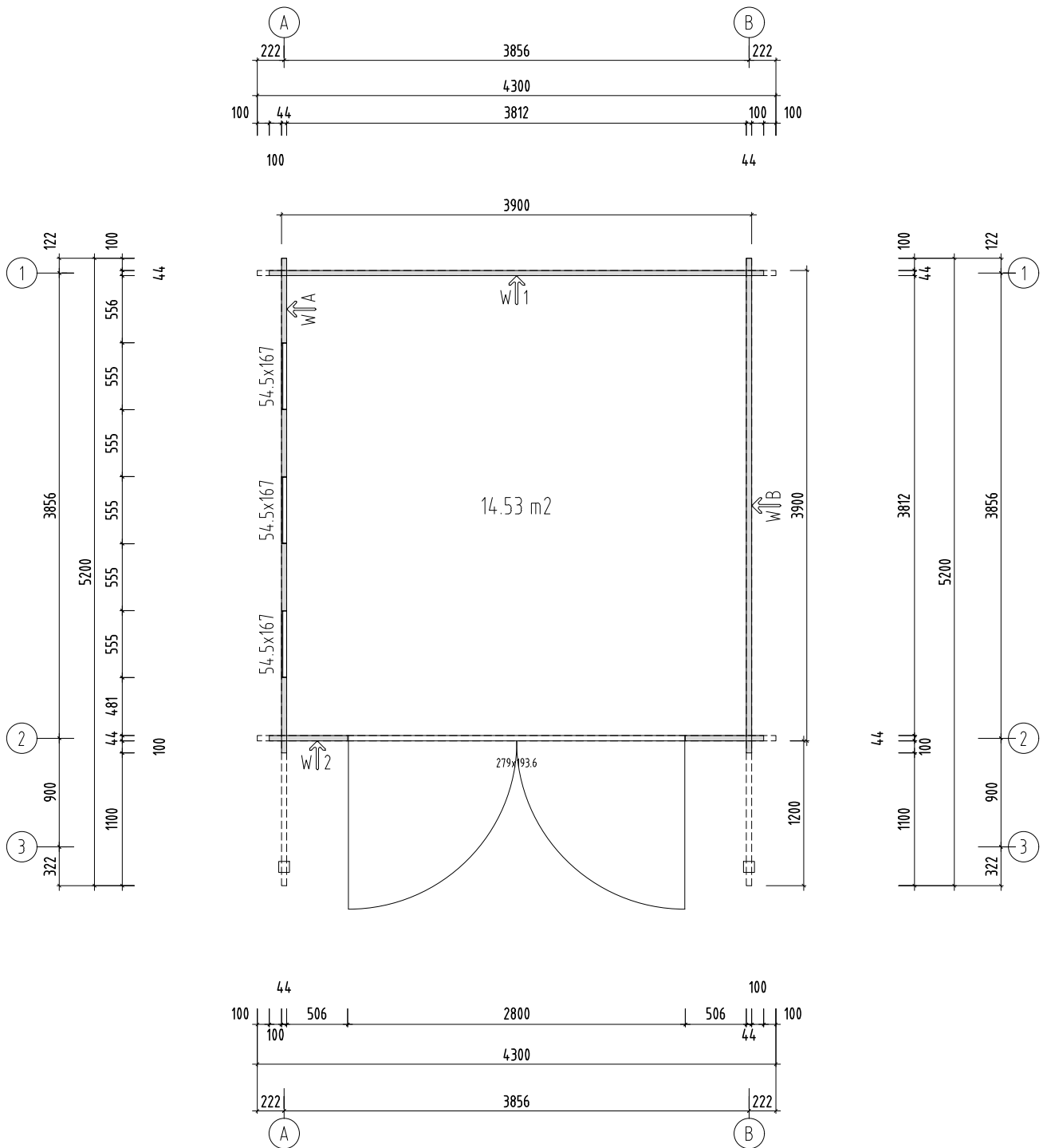

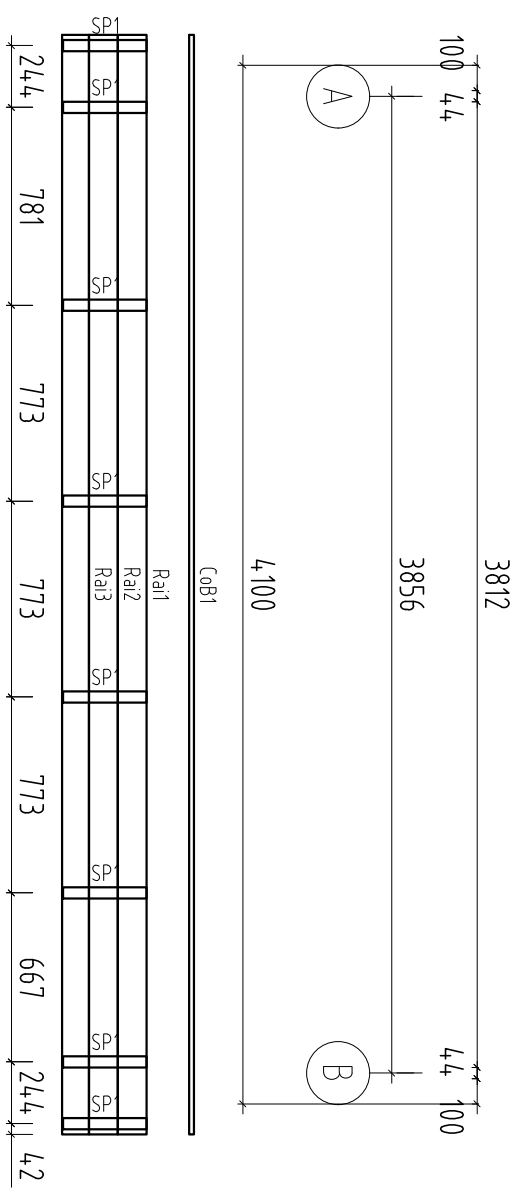
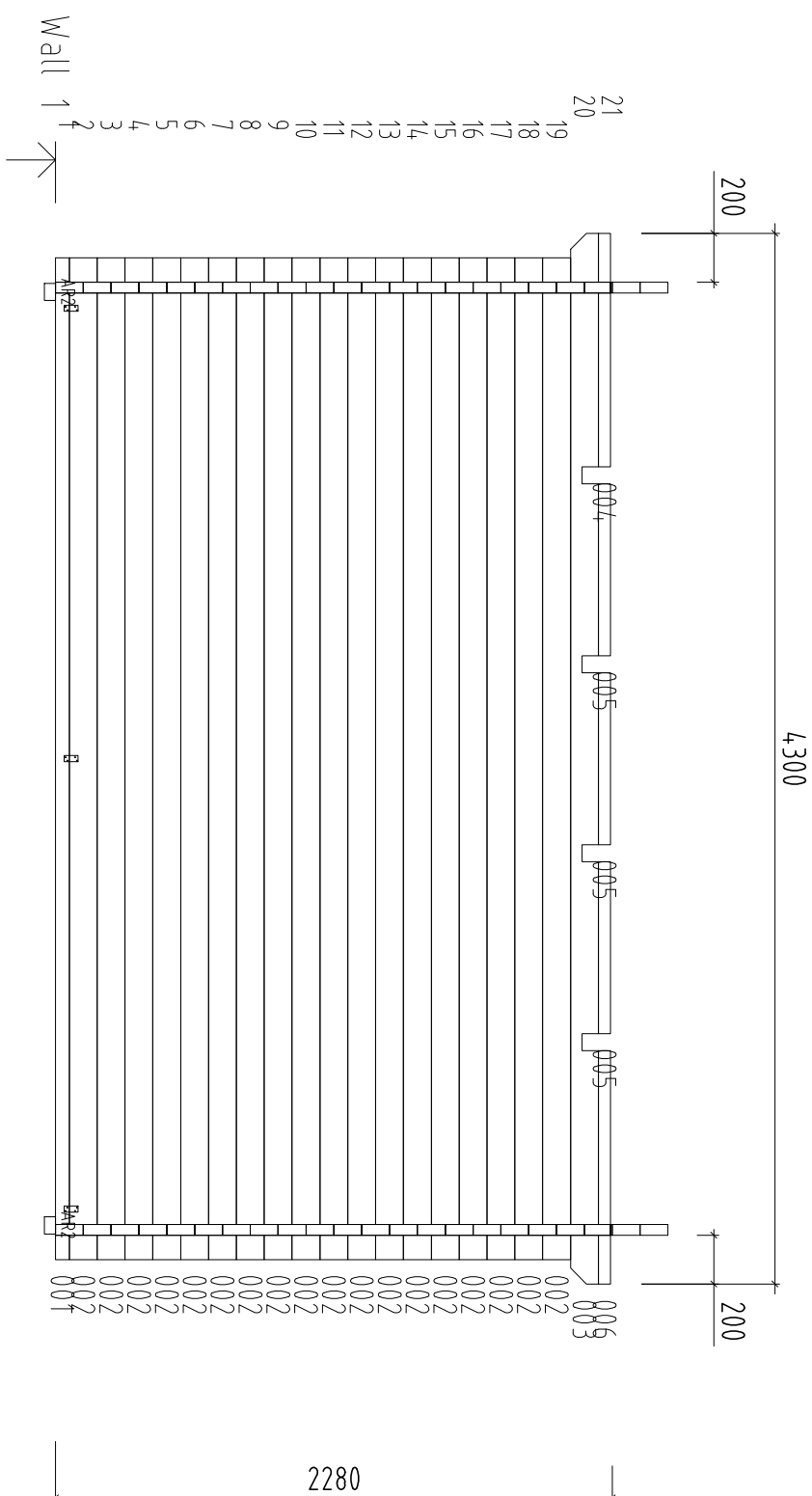



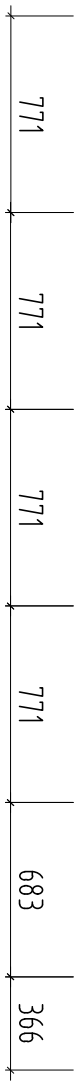
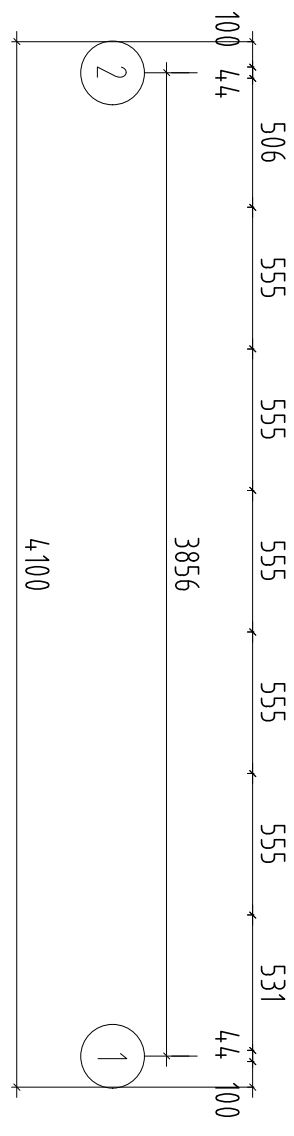
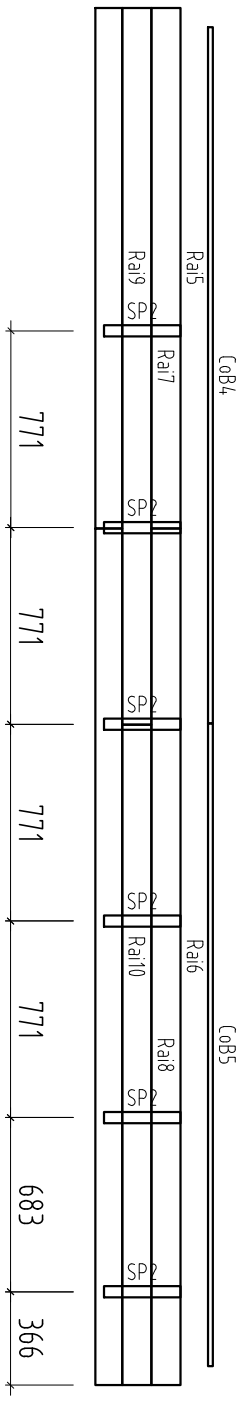
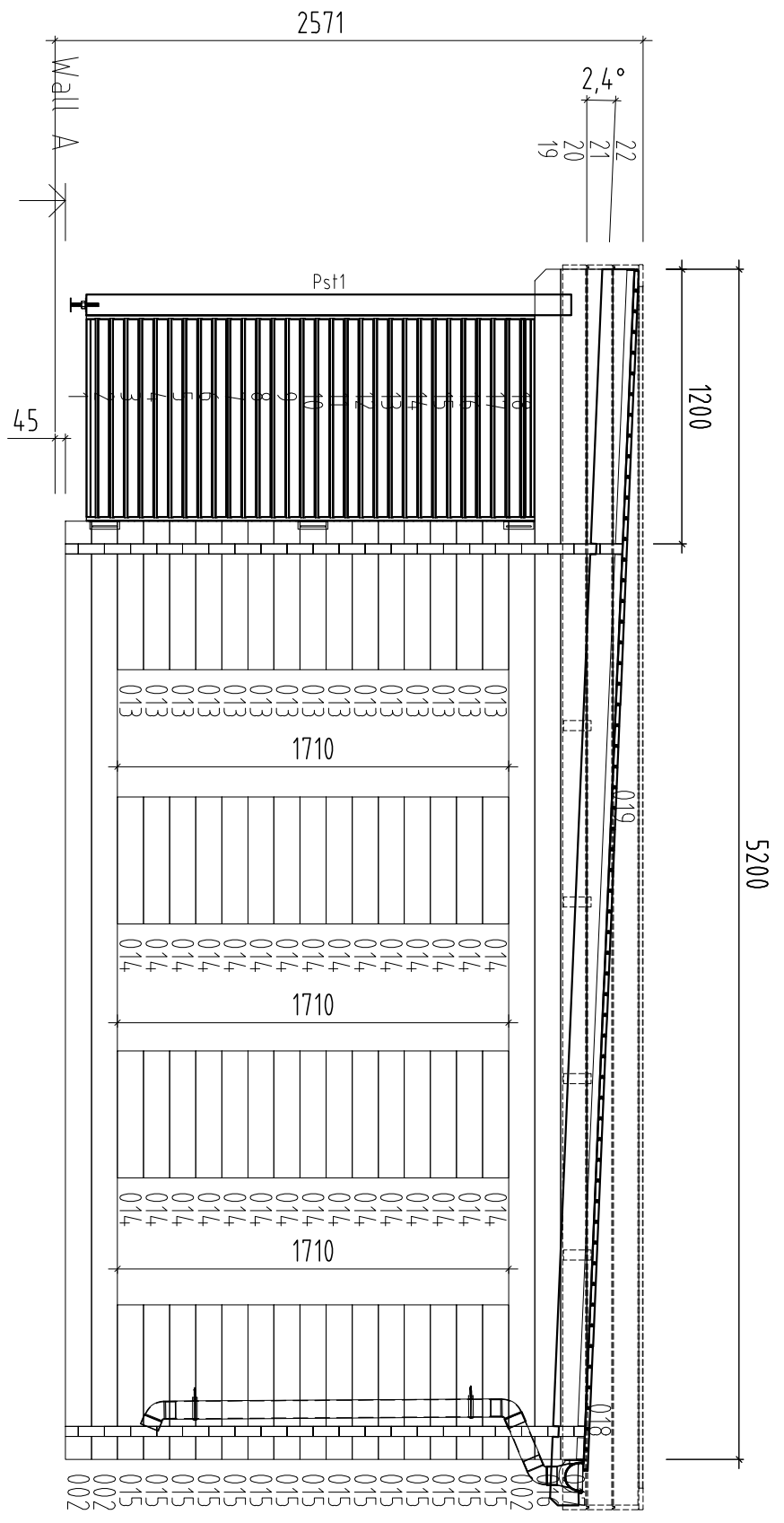

Wall B

22  
21  
20  
19

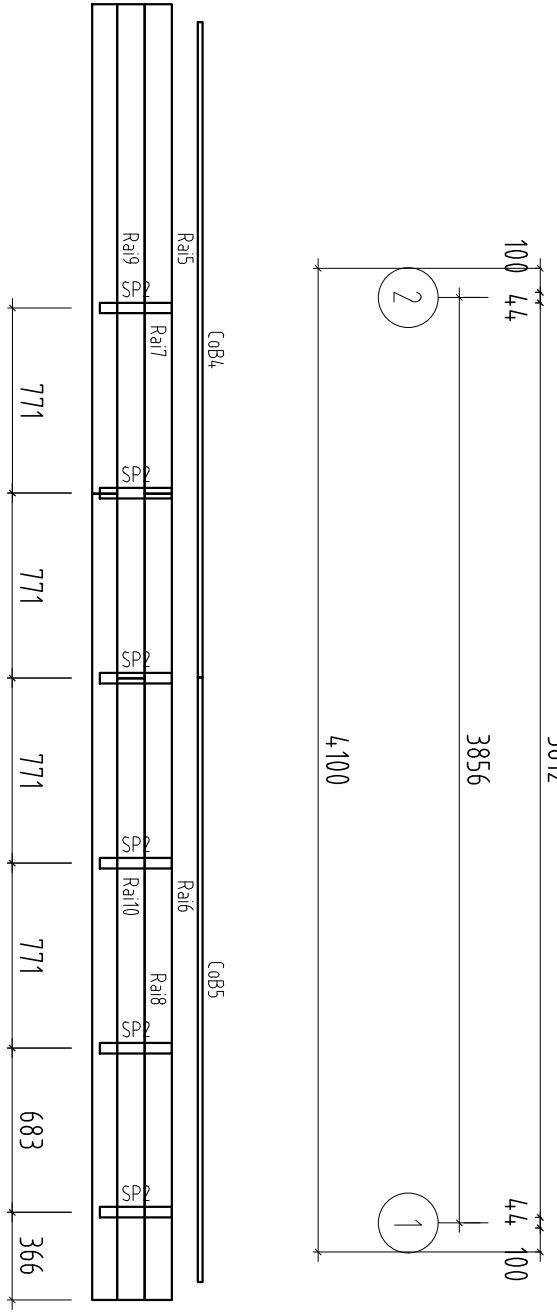
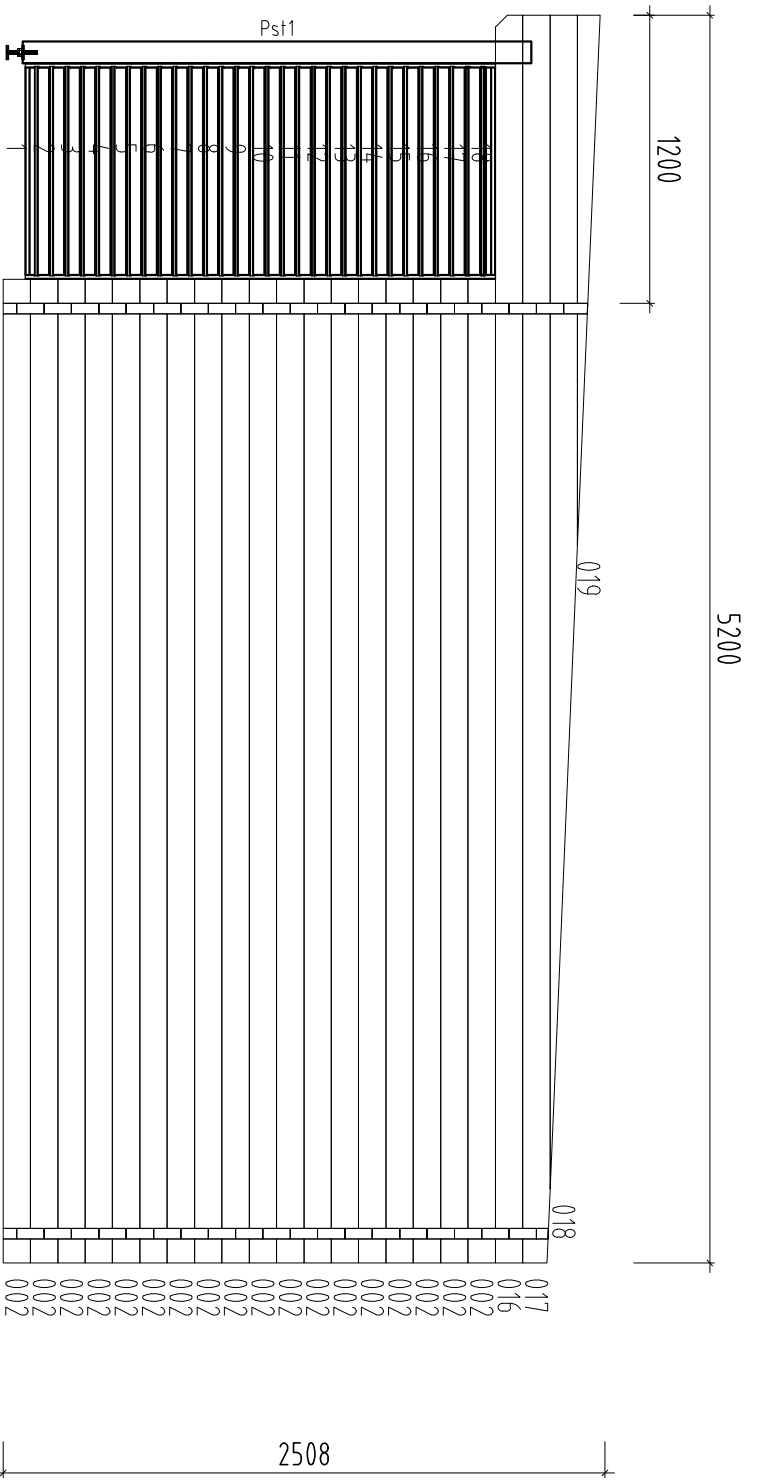

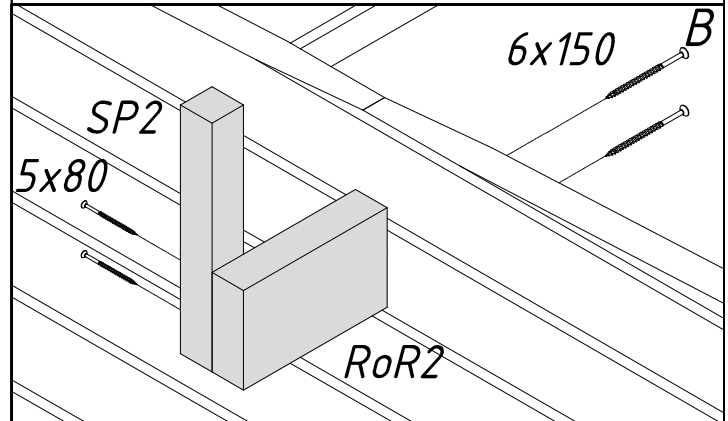
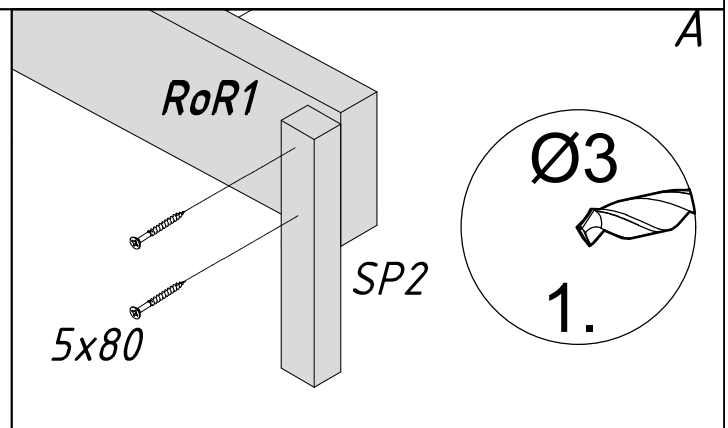
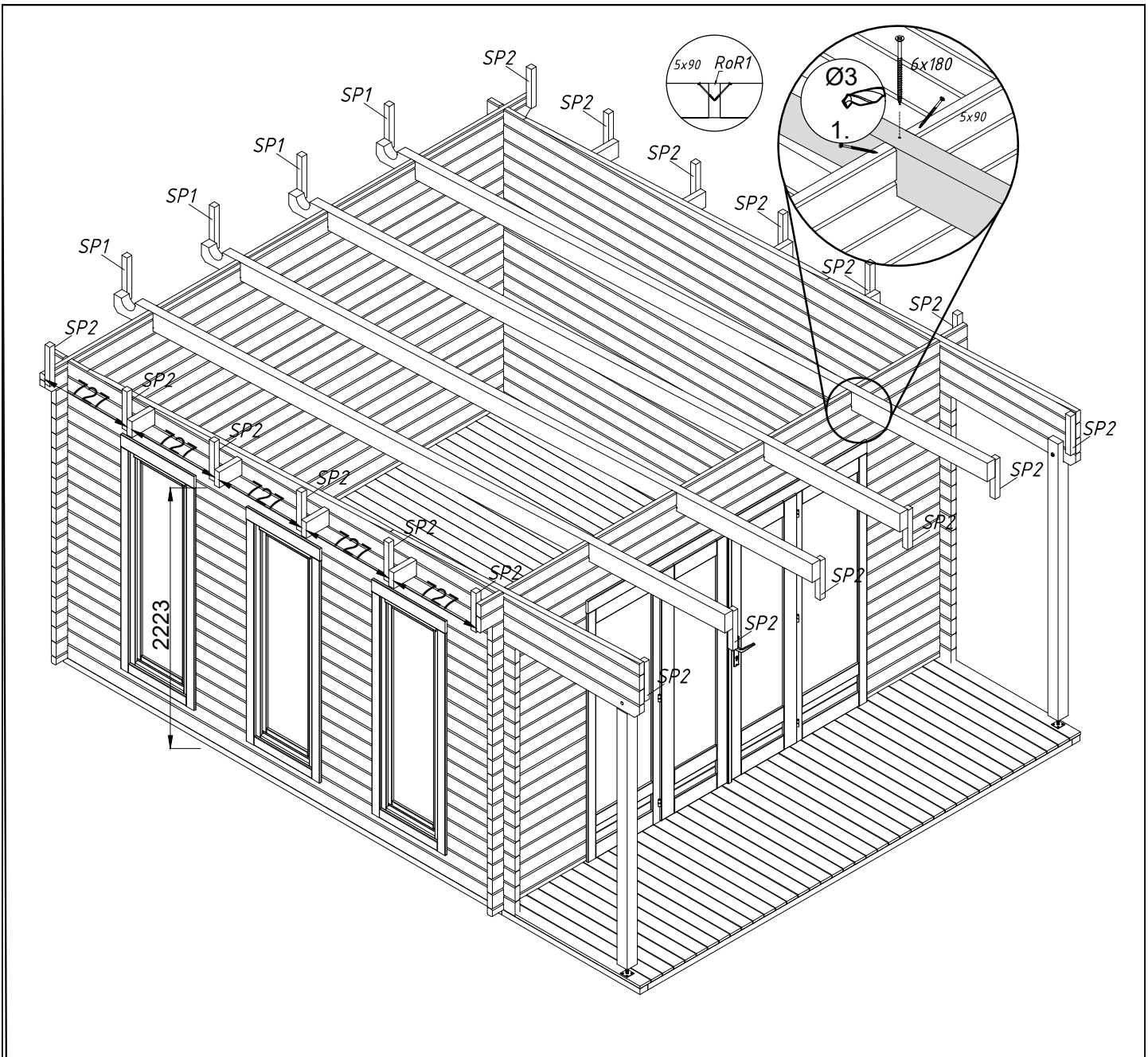

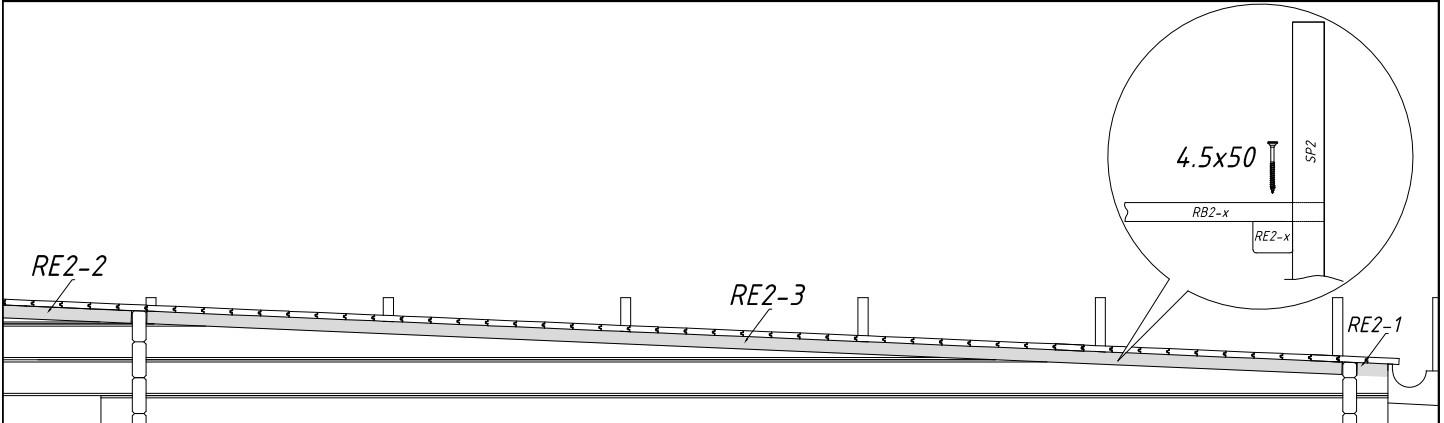
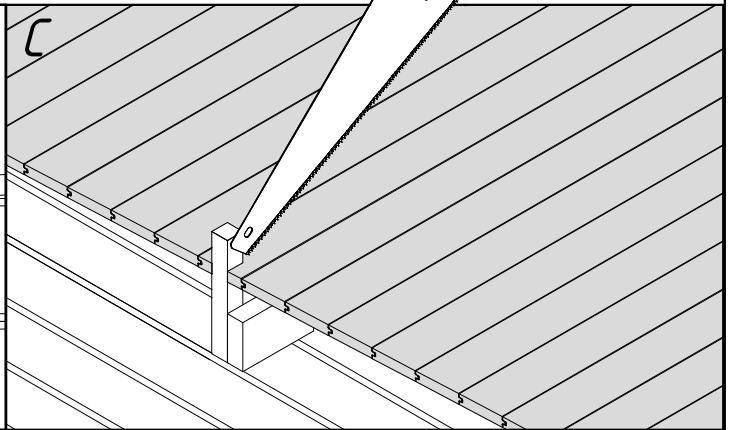
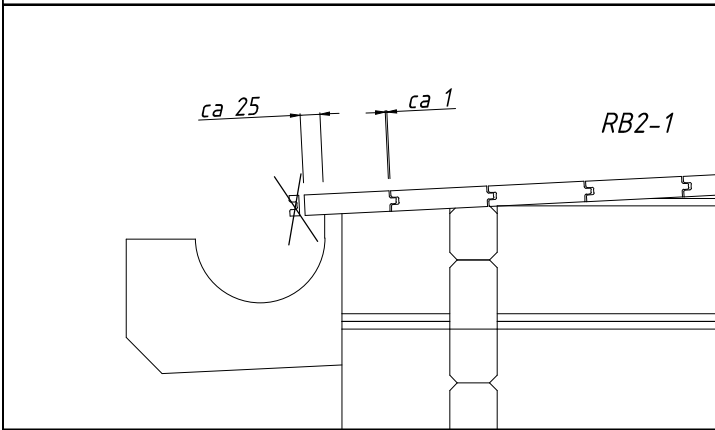
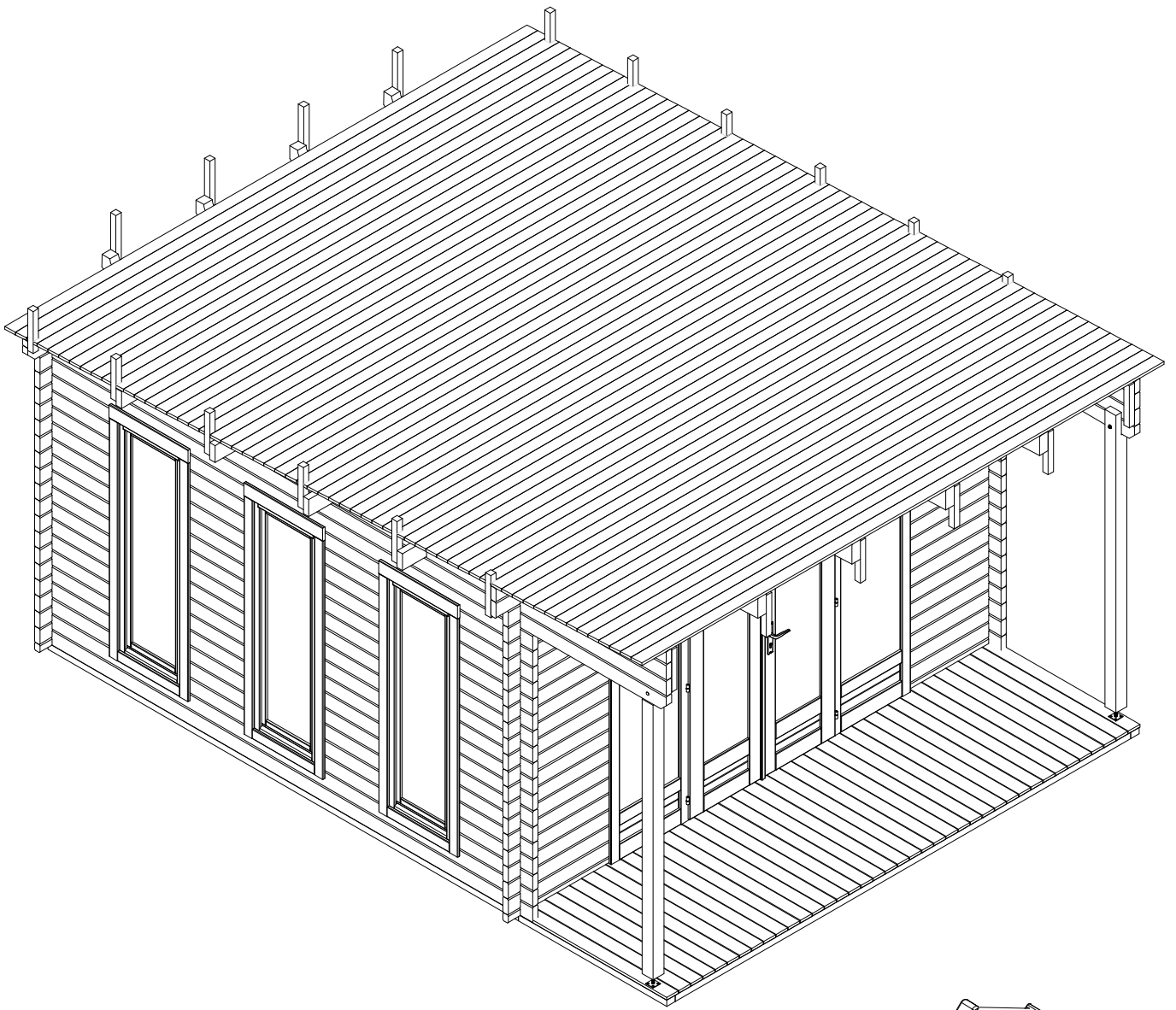

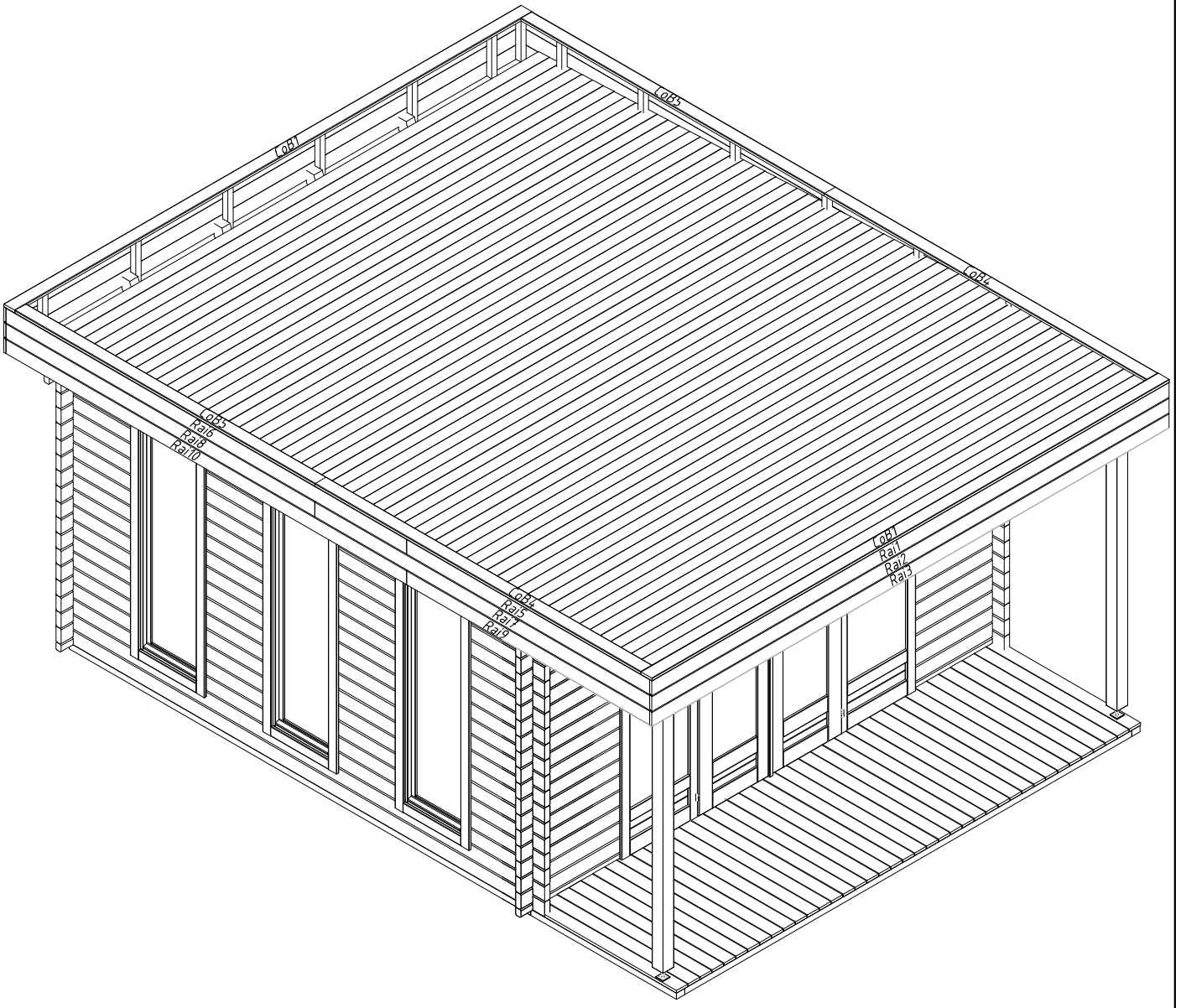



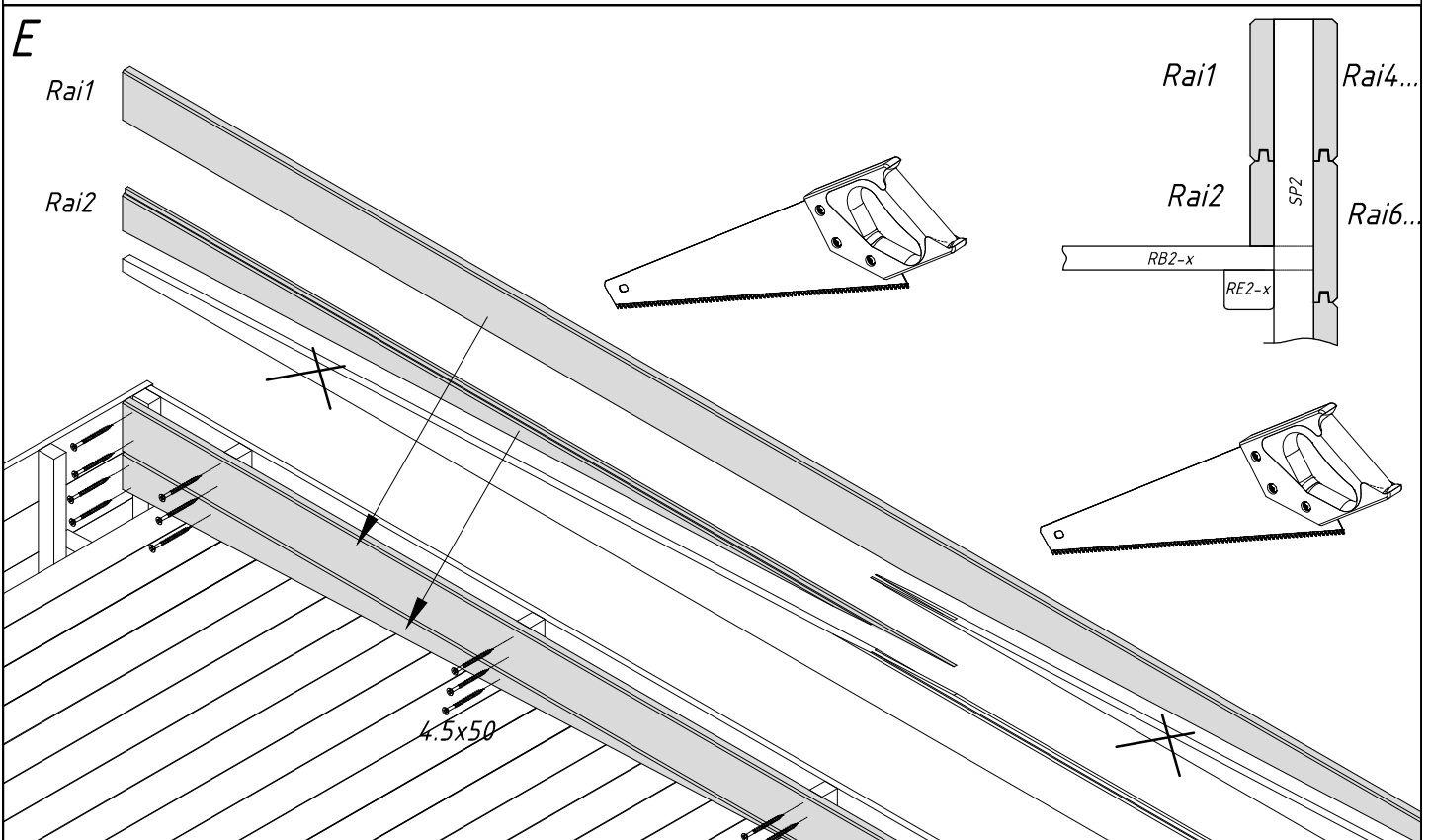
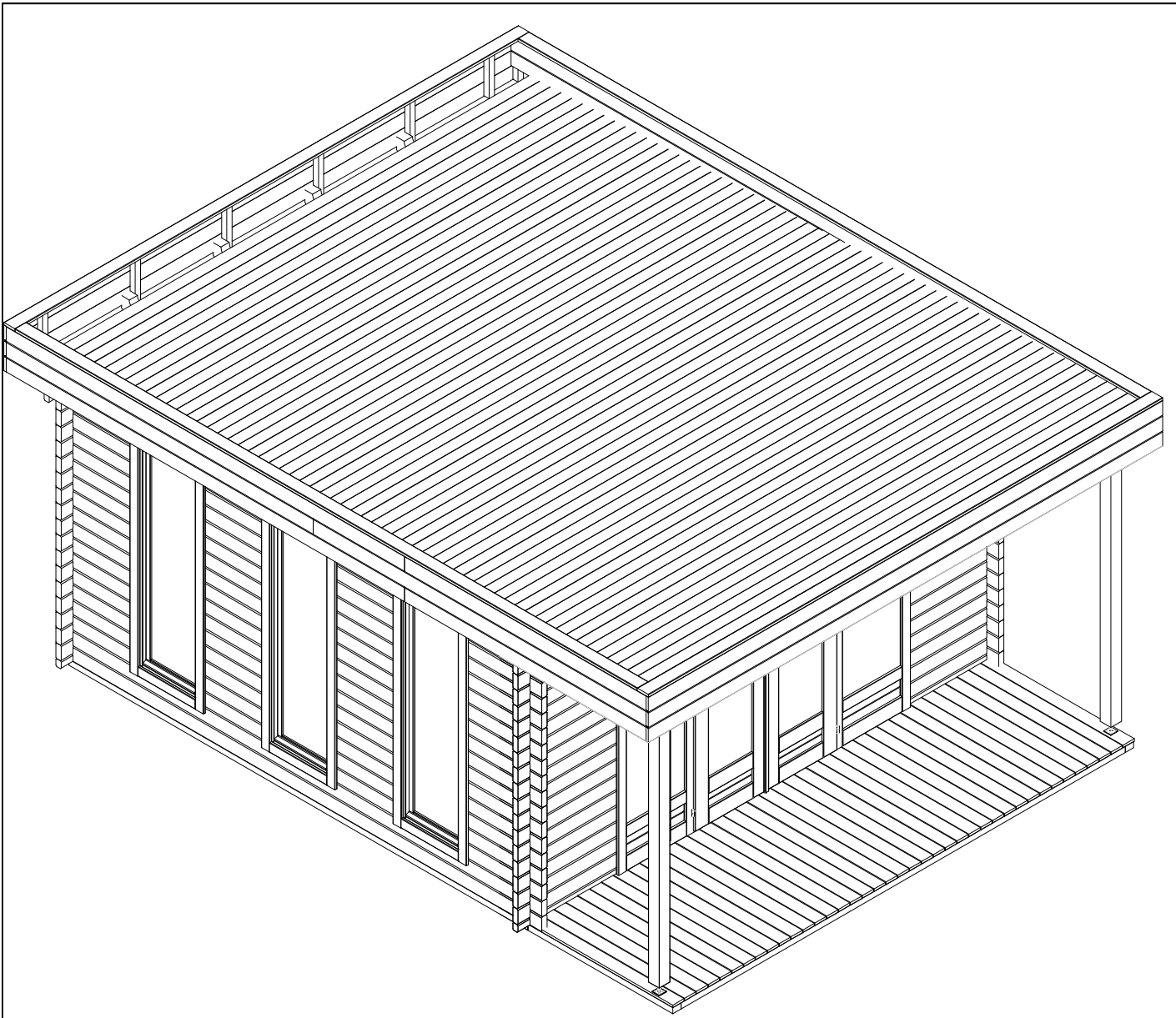

# SBS



\*underlayer is recommended

