

Ehte 3 40 (330x575)

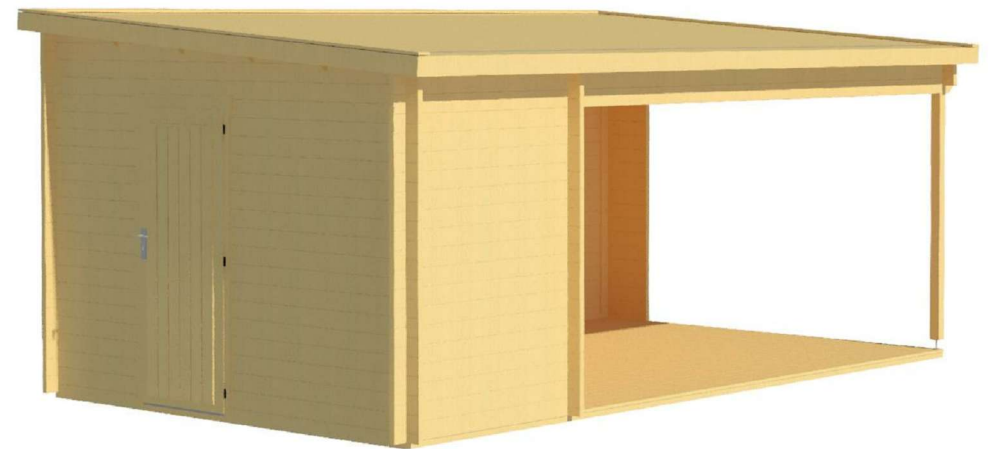

Ehte 3 40 (330x575)

Foundation

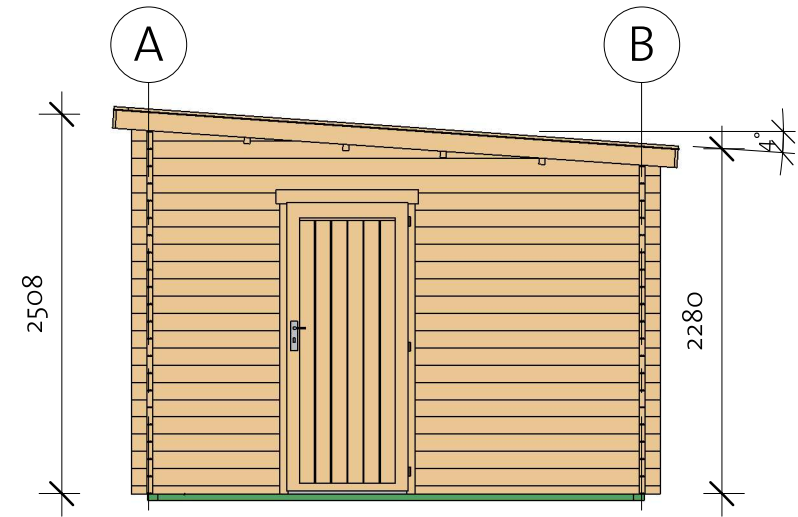
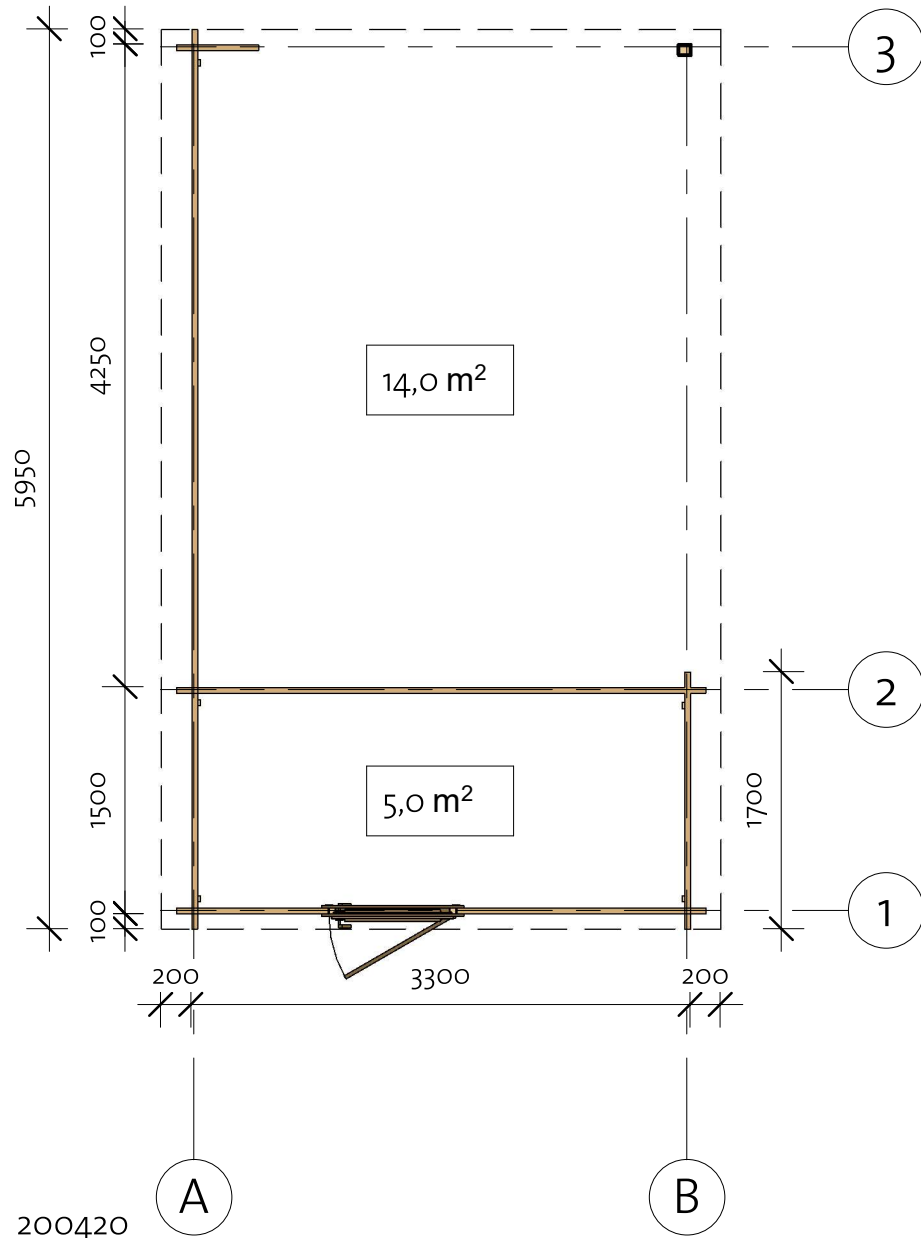
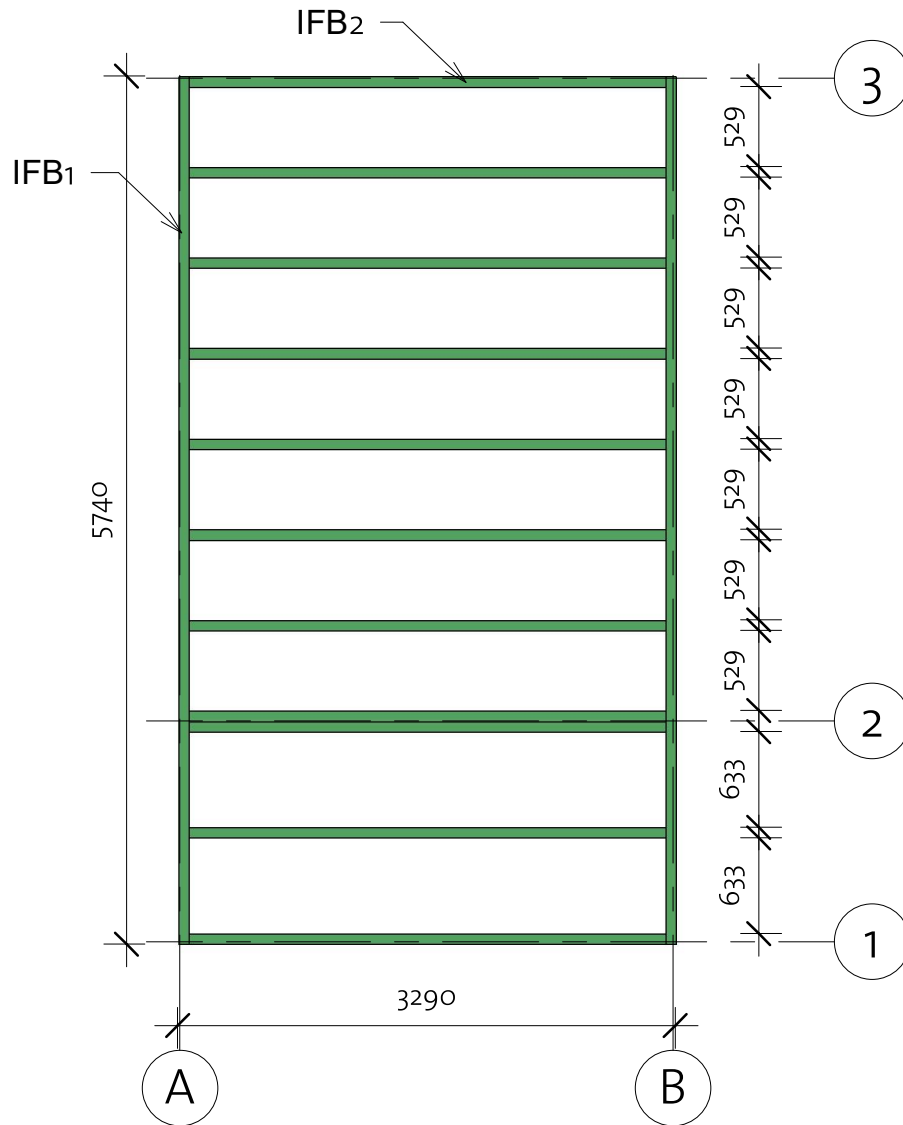

Impregnated foundation beams

Mark	Type	Profile	Count	Length
------	------	---------	-------	--------

IFB1	IFB 70x40		2	5740
IFB2	IFB 70x40		11	3150

Ehte 3 40 (330x575)

Floor Plan

① Baseboard

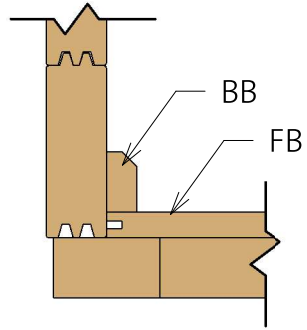

② TB

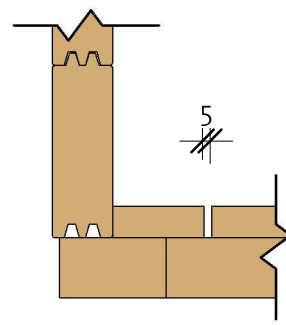

Floor Schedule

Mark	Type	Profile	Count	Length
------	------	---------	-------	--------

FB	FB 17x114		29	1414
TB	TB 21x95		34	4245

BB1	BB 20x40		1	5750
BB2	BB 20x40		4	3300

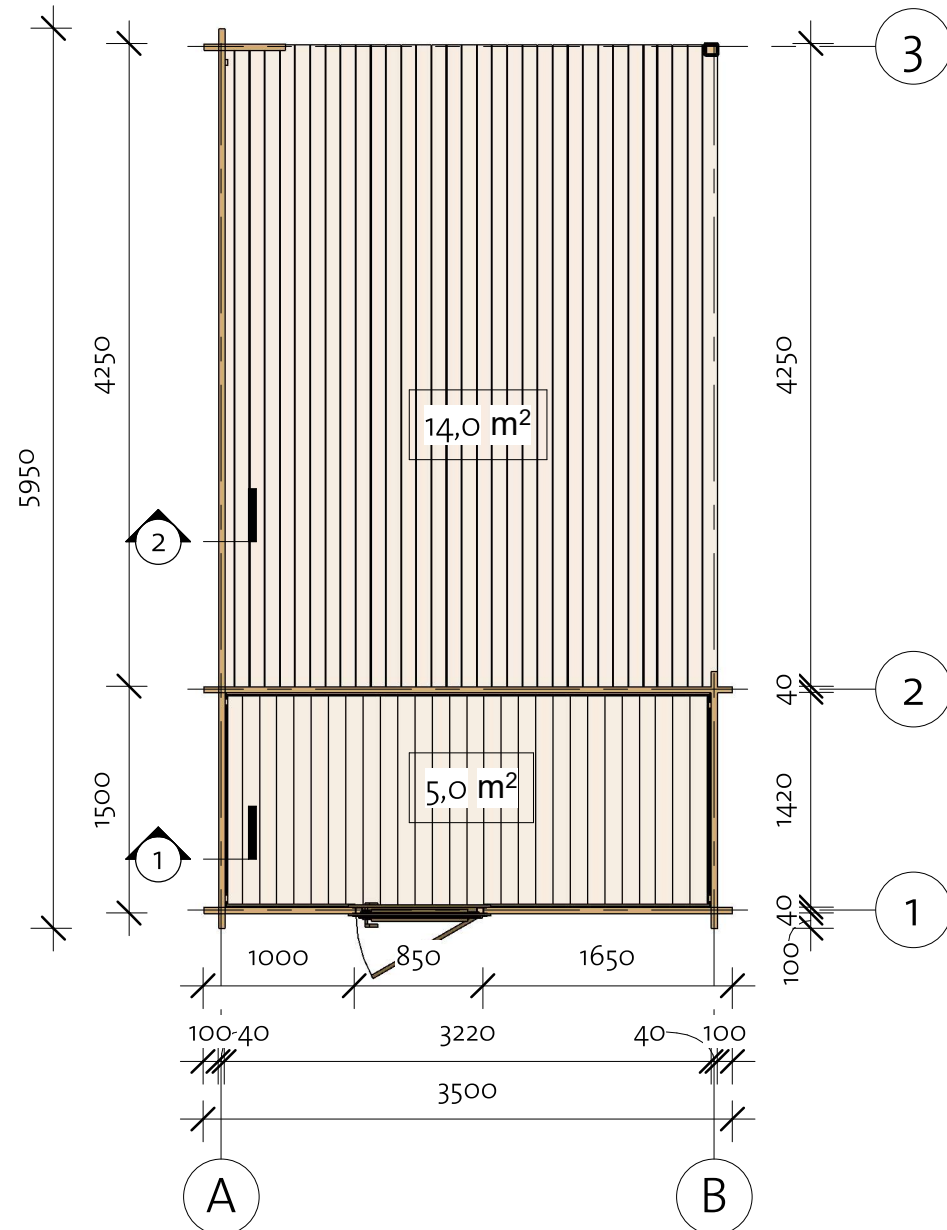

Ehte 3 40 (330x575)

Wall 2

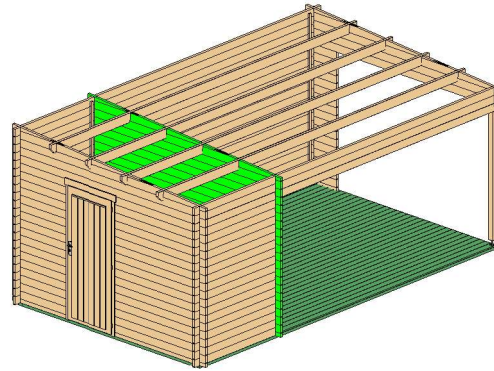

Wall 2			
Mark	Profile	Count	Cut Length

2BL-1	40x57	1	3500
2LG-1	40x114	1	915
2LG-3	40x114	1	3500
2LG-4	40x114	19	3500
2LG-2	40x114	1	2545

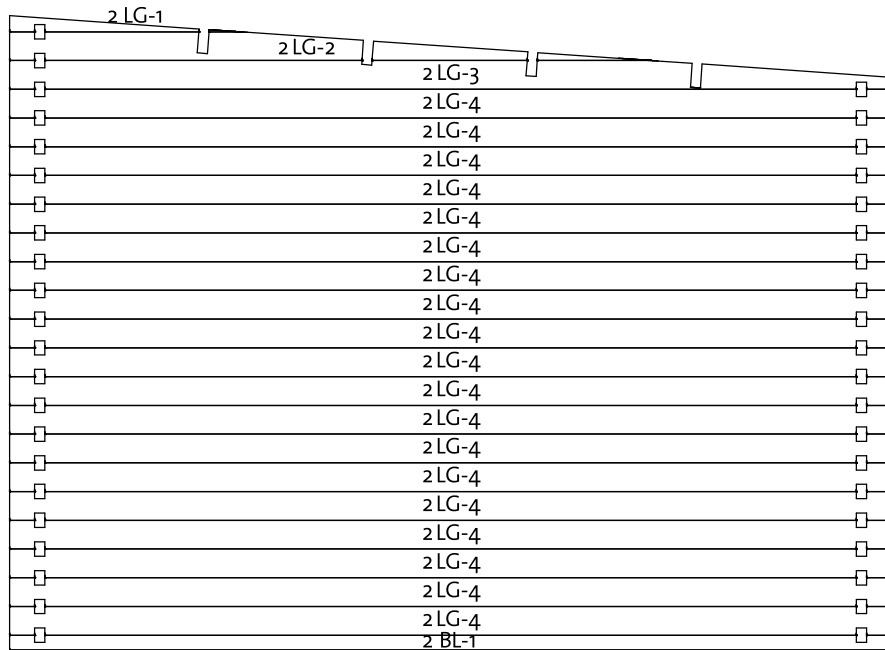

Log Profile Wall 2	
Profile	Profile

40x57	
40x114	

Ehte 3 40 (330x575)

Wall 3

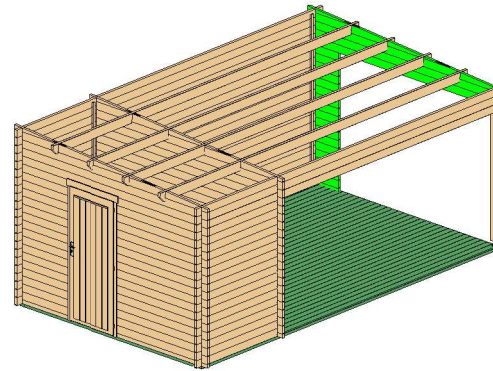

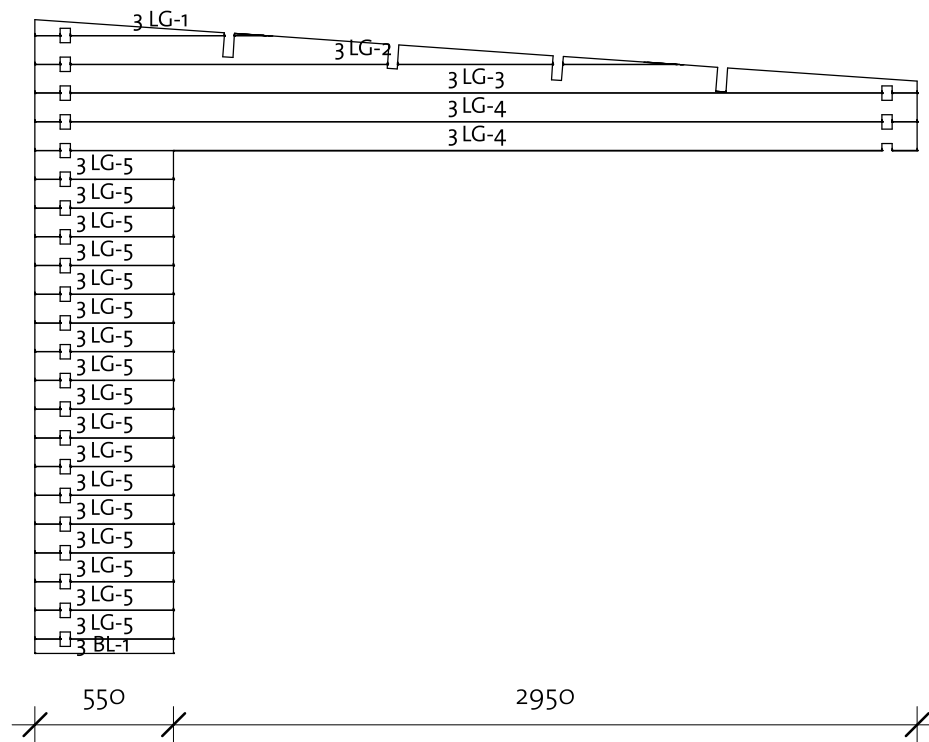

Wall 3			
Mark	Profile	Count	Cut Length

3BL-1	40x57	1	550
3LG-1	40x114	1	915
3LG-2	40x114	1	2545
3LG-3	40x114	1	3500
3LG-4	40x114	2	3500
3LG-5	40x114	17	550



Log Profile Wall 3	
Profile	Profile

40x57	
40x114	

Ehte 3 40 (330x575)

Wall B

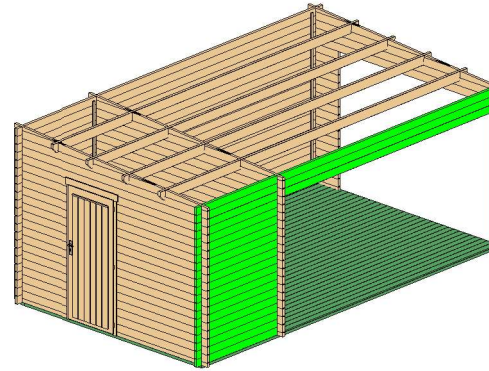

Wall B			
Mark	Profile	Count	Cut Length

BLG-1	40X114	1	5950
BLG-2	40X114	17	1700
BLG-3	40X114	1	5950
BTL-1	40X114	1	5950

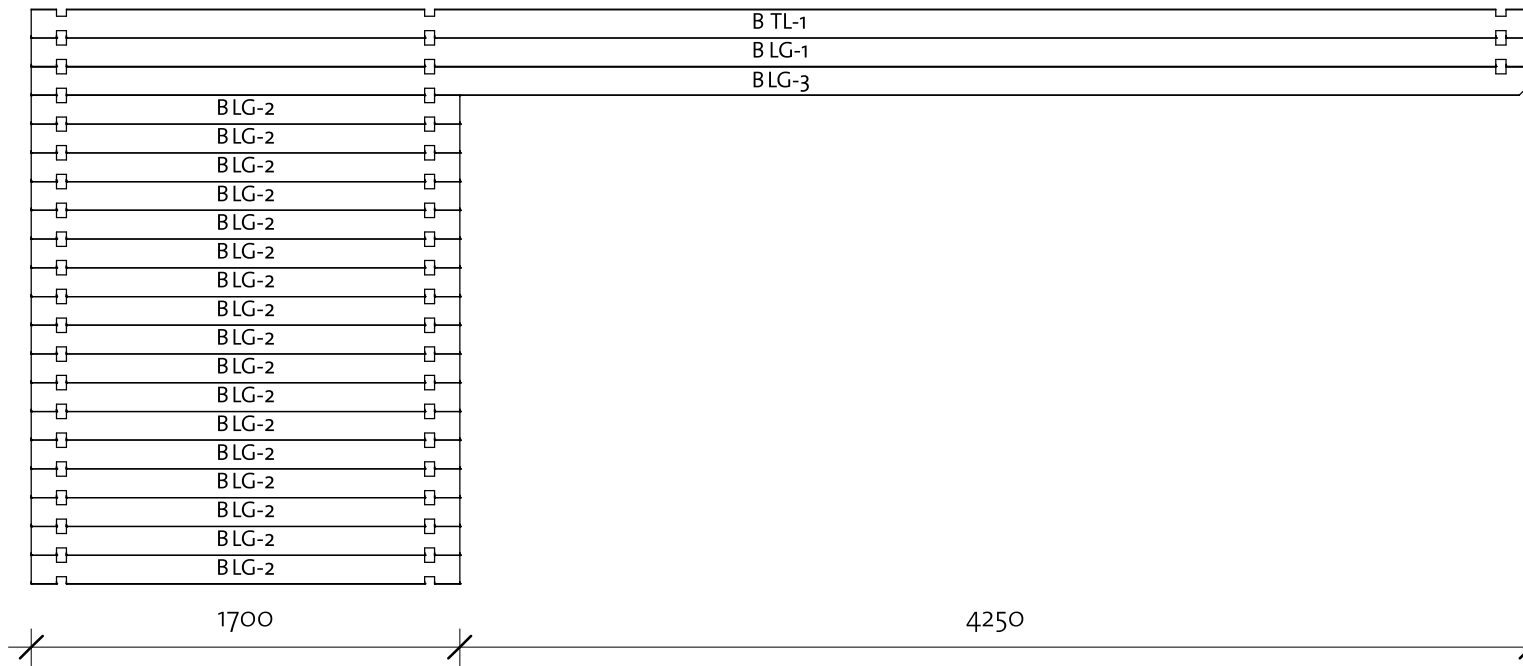

Log Profile Wall B	
Profile	Profile



40X114	
40X114	

Ehte 3 40 (330x575)

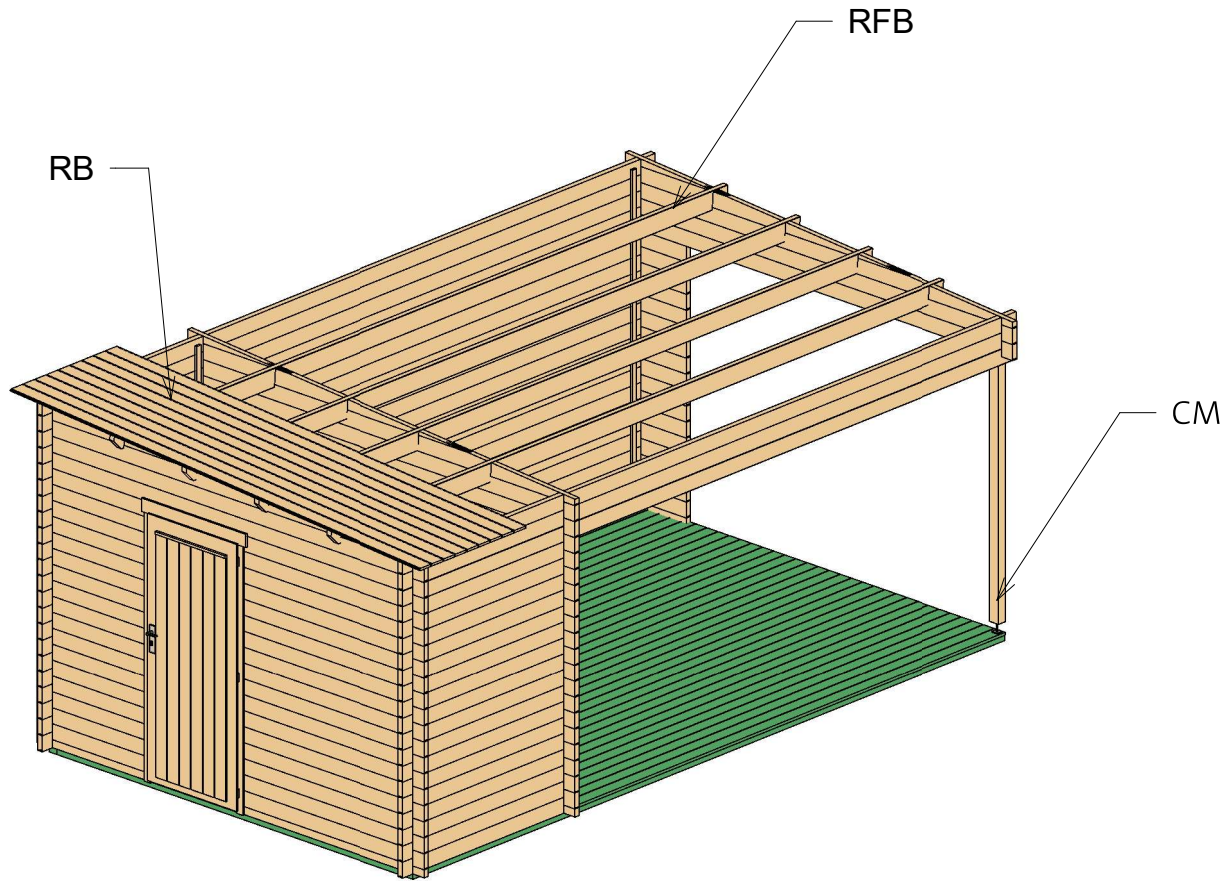
Roof 1



Roof				
Mark	Type	Profile	Count	Length

RB	17x114		53	3708
RFB	Beam 40x143		4	5950

Columns			
Mark	Profile	Count	Length

CM	Post 80x70	1	1899
----	------------	---	------

Ehte 3 40 (330x575)

Roof 2

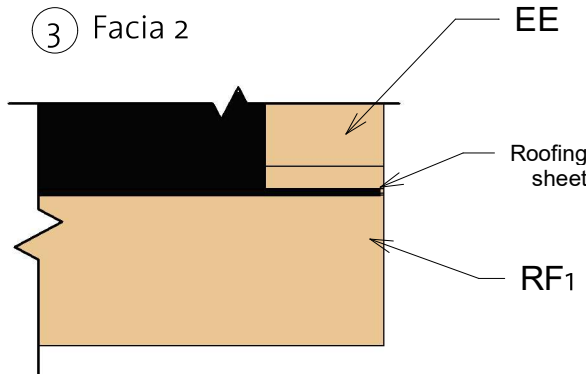
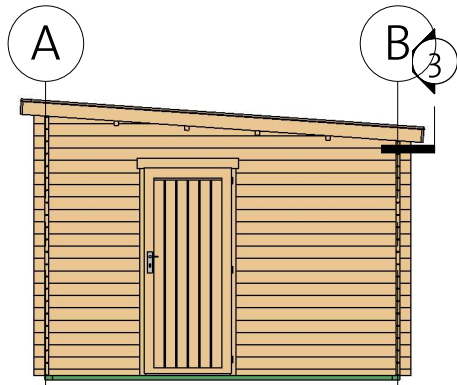
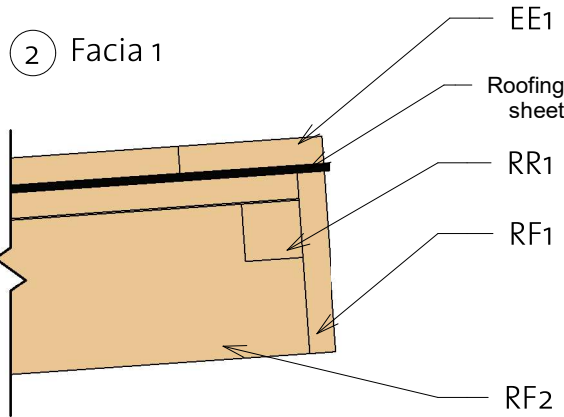
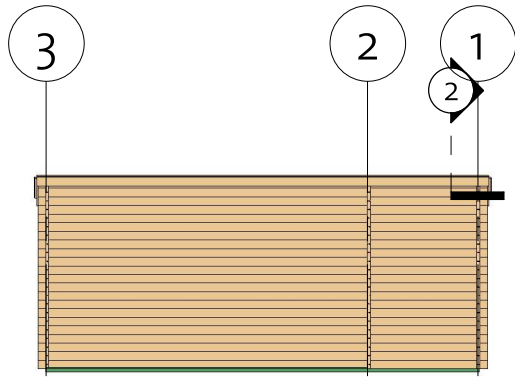

Fascia Schedule				
Mark	Type	Profile	Count	Length
EE1	Eave Edging 18x95		1	5986
EE2	Eave Edging 18x95		2	3649
RF1	Roof Fascia 18x120		2	5986
RF2	Roof Fascia 18x120		2	3708
RR1	Roof reinforcement 38x38		2	5950

Ehte 3 40 (330x575)

Extras

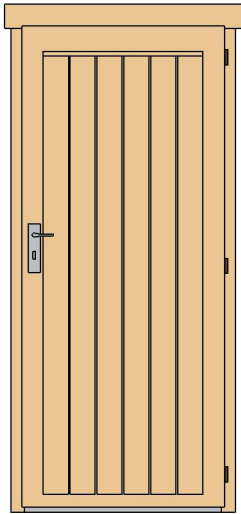

Door Schedule				
Model	Type	Width	Height	Count
CD7R	Classic door 7, wood right	840	1955	1

Fasteners/Extras		
Name	Type	Count

Hitblock	300-400 mm	
Bolts	M8x70	15
Screws	4,5 x 70	25
Nails	1,4 x 40	42
Screws	6,0 x 140	70
Screws	4,0 x 40	100
Screws	4,0 x 50	1000

Type	Count	Length
Windboard 18x40	5	2400

Adjustable post foot	1
-------------------------	---





Ehte 3 40 (330x575)

List of all items 1

Impregnated foundation beams

Mark	Type	Profile	Count	Length
IFB1	IFB 70x40		2	5740
IFB2	IFB 70x40		11	3150

Floor Schedule



Mark	Type	Profile	Count	Length
FB	FB 17x114		29	1414
TB	TB 21x95		34	4245

BB1	BB 20x40		1	5750
BB2	BB 20x40		4	3300





Columns

Mark	Profile	Count	Length
CM	Post 80x70	1	1899

Roof

Mark	Type	Profile	Count	Length
RB	17x114		53	3708
RFB	Beam 40x143		4	5950

Fascia Schedule

Mark	Type	Profile	Count	Length
EE1	Eave Edging 18x95		1	5986
EE2	Eave Edging 18x95		2	3649
RF1	Roof Fascia 18x120		2	5986
RF2	Roof Fascia 18x120		2	3708
RR1	Roof reinforc ement 38x38		2	5950

Ehte 3 40 (330x575)

List of all items 2

Wall 1			
Mark	Profile	Count	Cut Length

1BL-1	40x57	1	1000
1BL-2	40x57	1	1650
1LG-1	40x114	1	915
1LG-2	40x114	1	2545
1LG-3	40x114	1	3500
1LG-4	40x114	2	3500
1LG-5	40x114	17	1650
1LG-6	40x114	17	1000

Wall 3			
Mark	Profile	Count	Cut Length

3BL-1	40x57	1	550
3LG-1	40x114	1	915
3LG-2	40x114	1	2545
3LG-3	40x114	1	3500
3LG-4	40x114	2	3500
3LG-5	40x114	17	550

Log profiles	
Profile	Profile

40x57	
-------	---

Wall 2			
Mark	Profile	Count	Cut Length

2BL-1	40x57	1	3500
2LG-1	40x114	1	915
2LG-3	40x114	1	3500
2LG-4	40x114	19	3500
2LG-2	40x114	1	2545

Wall A			
Mark	Profile	Count	Cut Length

ALG-1	40x114	21	5950
ATL-1	40x114	1	5950

Wall B			
Mark	Profile	Count	Cut Length

BLG-1	40x114	1	5950
BLG-2	40x114	17	1700
BLG-3	40x114	1	5950
BTL-1	40x114	1	5950

Log profiles	
Profile	Profile

40x114	
40x114	