

# Techn. Data: Annika

Log length (W x D): 300 x 500 cm

Wall size(outside): 280 x 480 cm · Log thickness: 40 mm

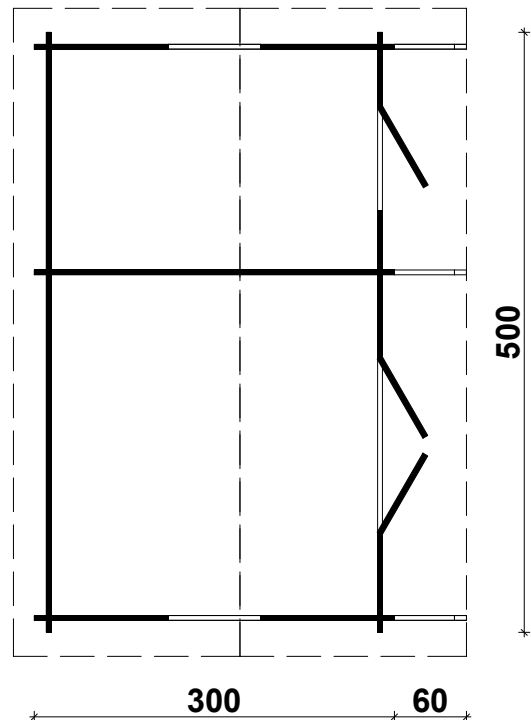

Note: All dimensions are approximate !

# Annika 40 mm / 300 x 500 cm

## Foundation beams

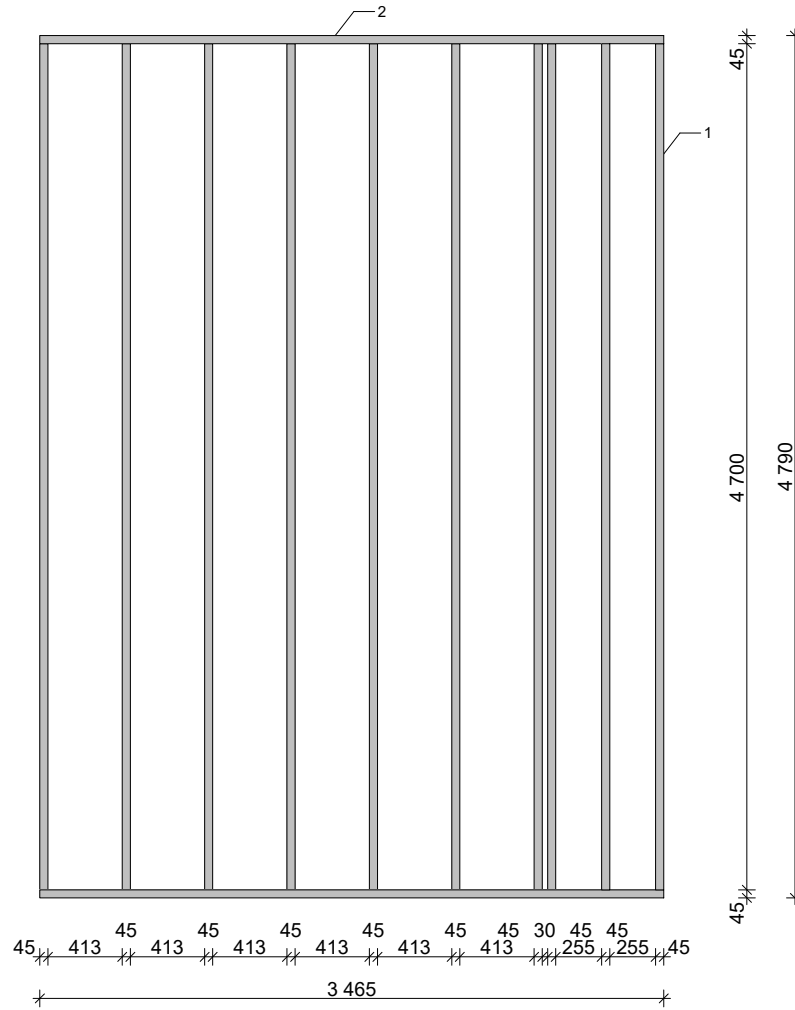

# Annika 40 mm / 300 x 500 cm

## Ground plan

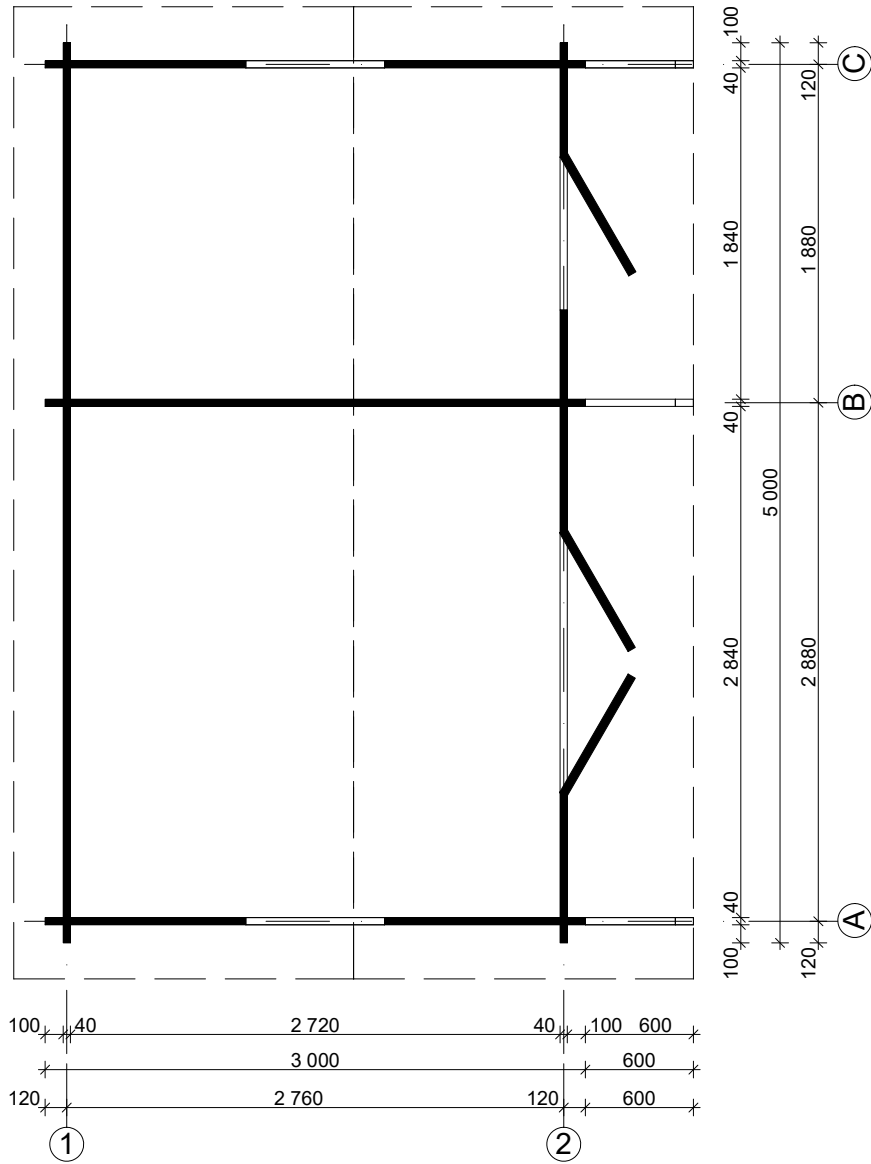

# Annika 40 mm / 300 x 500 cm

**A, C**

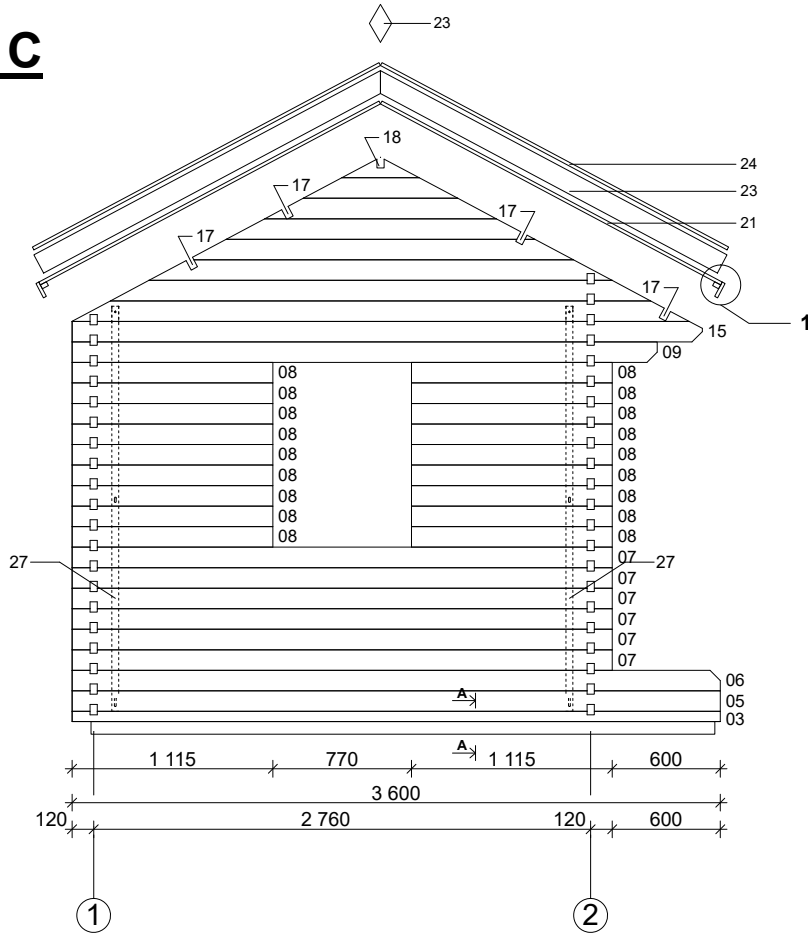

**1**

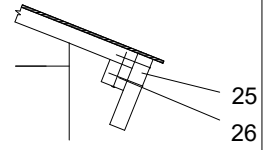

**B-B**

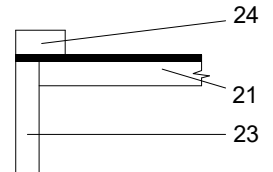

**B**

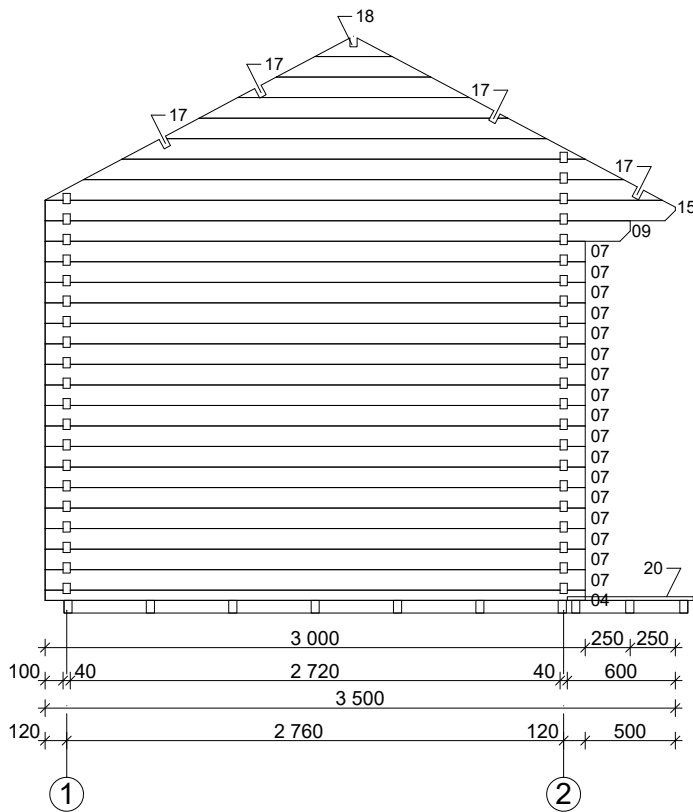

**A-A**

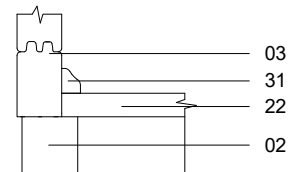

# Annika 40 mm / 300 x 500 cm



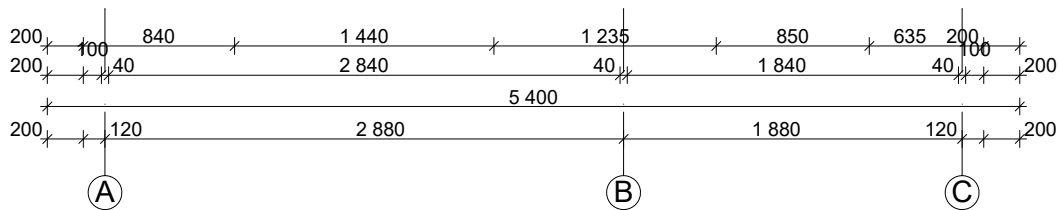
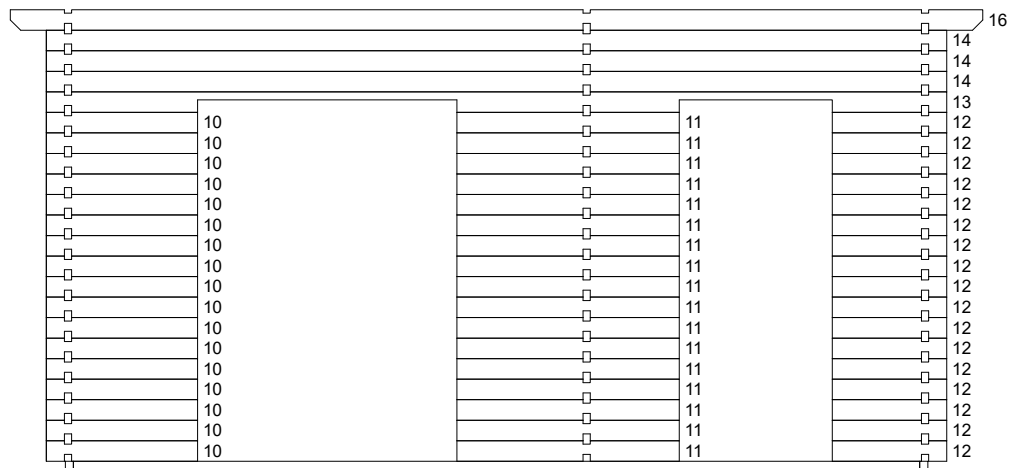
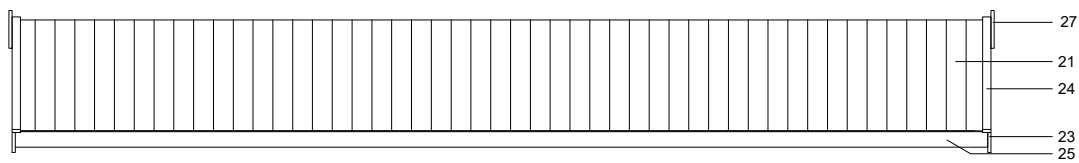



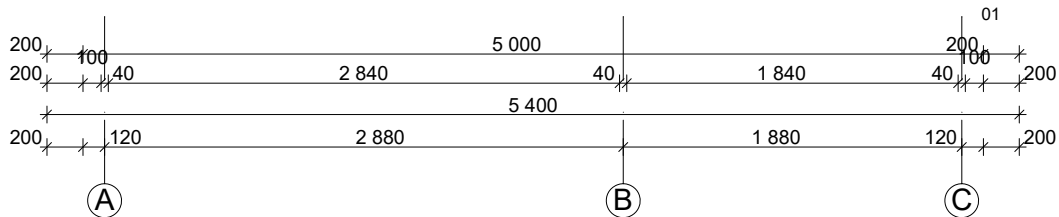
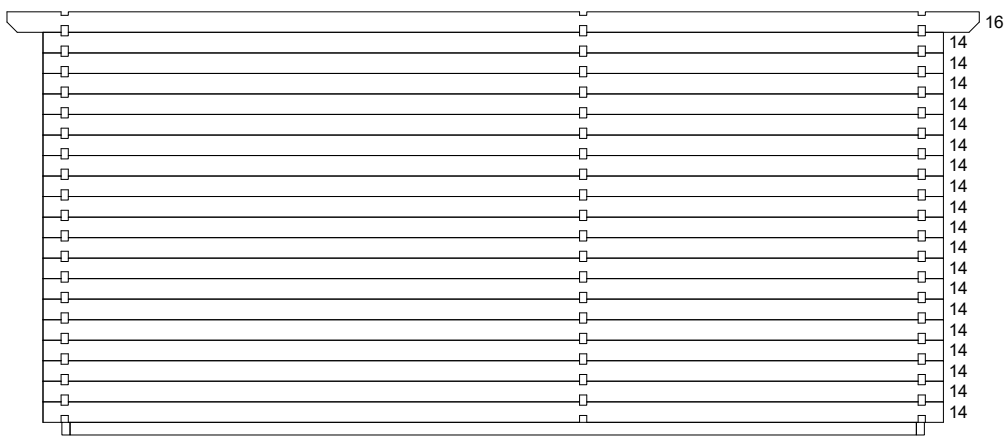



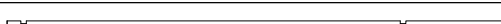

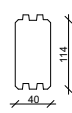

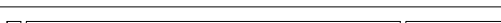

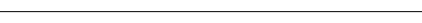







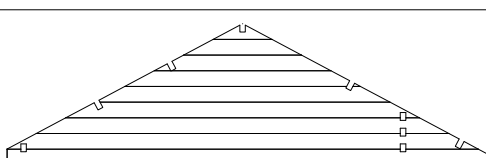



**2**



**1**

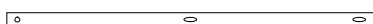

# Specification - Annika 40 mm / 300 x 500 cm

Nr	Description	Profile mm	Length mm	Quantity	
1	Foundation 	45x70	4700	10	
2			3465	2	
3		 	3600	2	
4			3000	1	
5			3600	2	
6			3600	2	
7			3000	29	
8			1115	36	
9			3250	3	
10			840	17	
11			1235	17	
12			635	17	
13			5000	1	
14			5000	22	
15				3500	3
16			 40 x 132	5400	2(1+1)
17		 40 x 120	5400	4	
18		 40 x 120	5400	1	
19	Roofing felt		--	--	
20	Terrace board	 21x95	700	48	
21	Roof board	 18x110	2140	100+2	
22	Floor board	 28x110	2717	43+1	
23	Facia board 	18x115	2180	4	
24	Eave edging	18x90	2180	4	
25	Roof edge reinforcement	18x90	5400	2	
26	Roof edge reinforcement	25x36	2700	4	
27	Diamond 			2	
28	Screws 4,0 x 40 ; 4,0 x 50			80/1000	
29	Screws 5,0 x 100 ; 6,0 x 140			50/30	
30	Nails 1,4 x 35			50	
31	Storm braces 		2250	4	
32	Baseboard 			ca. 20,0 m	



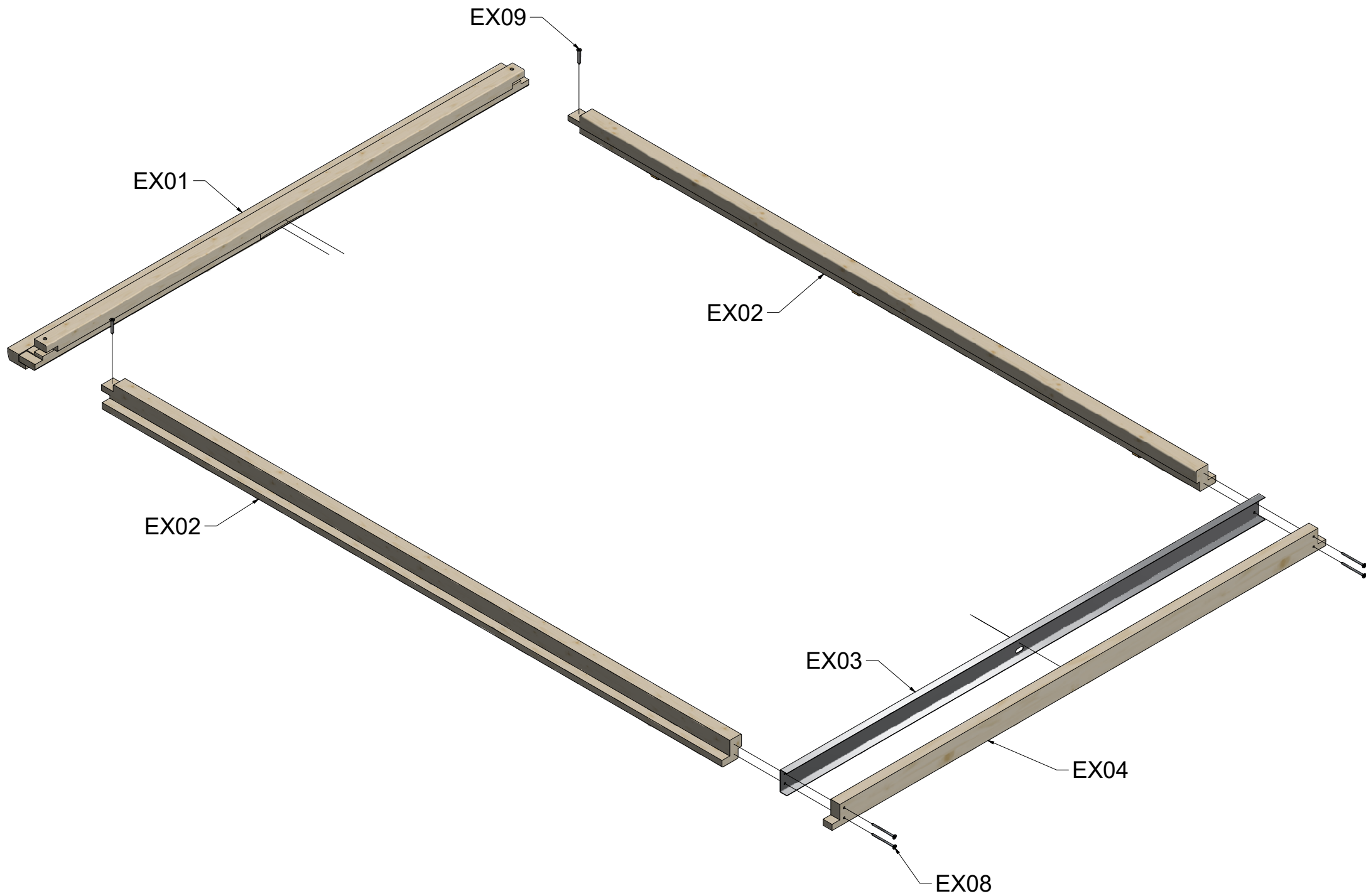



# Double Door Frame 40mm

EX05

EX06

AY

EX06

EX09

EX01

EX02

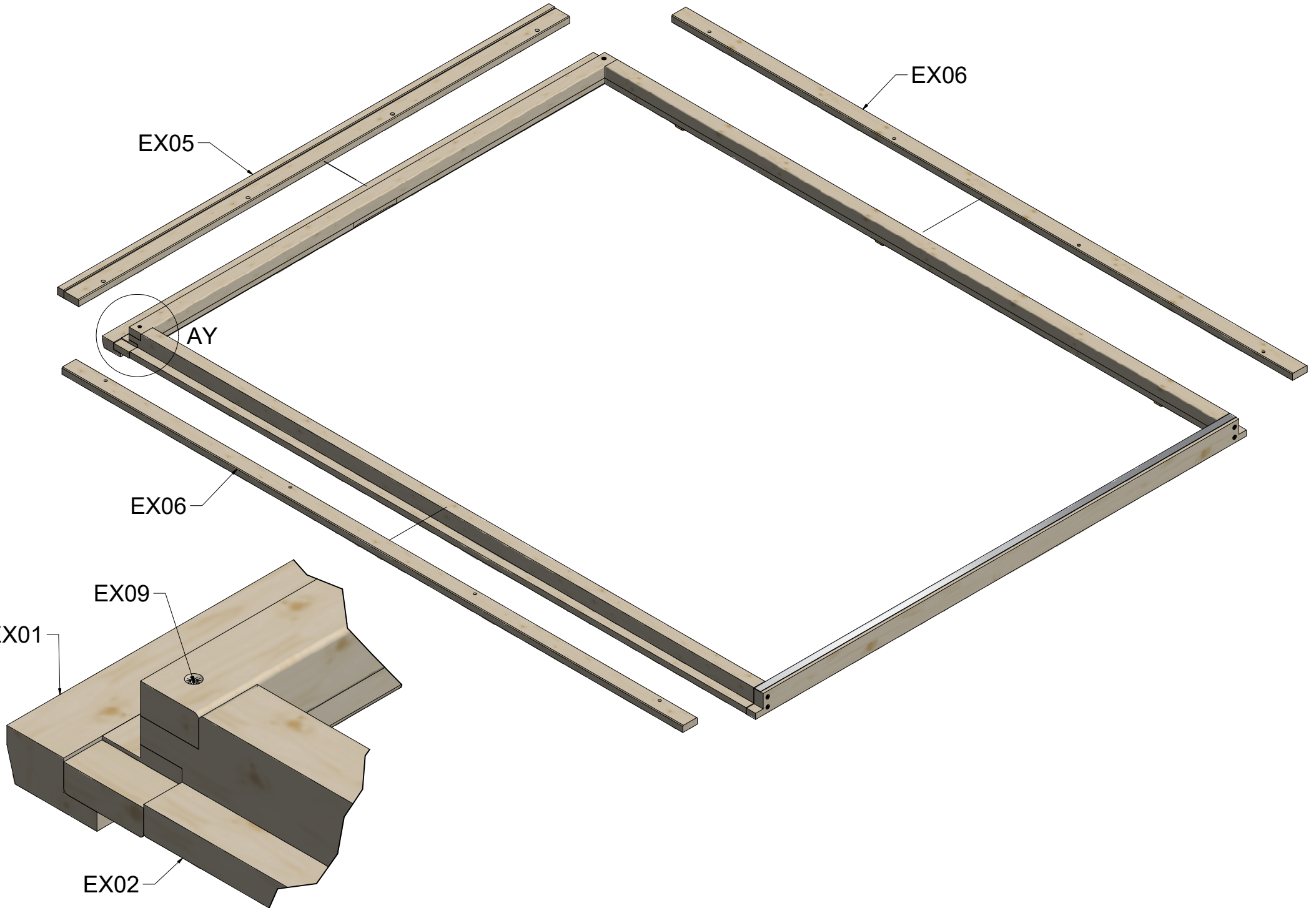

# Double Door Frame 40mm

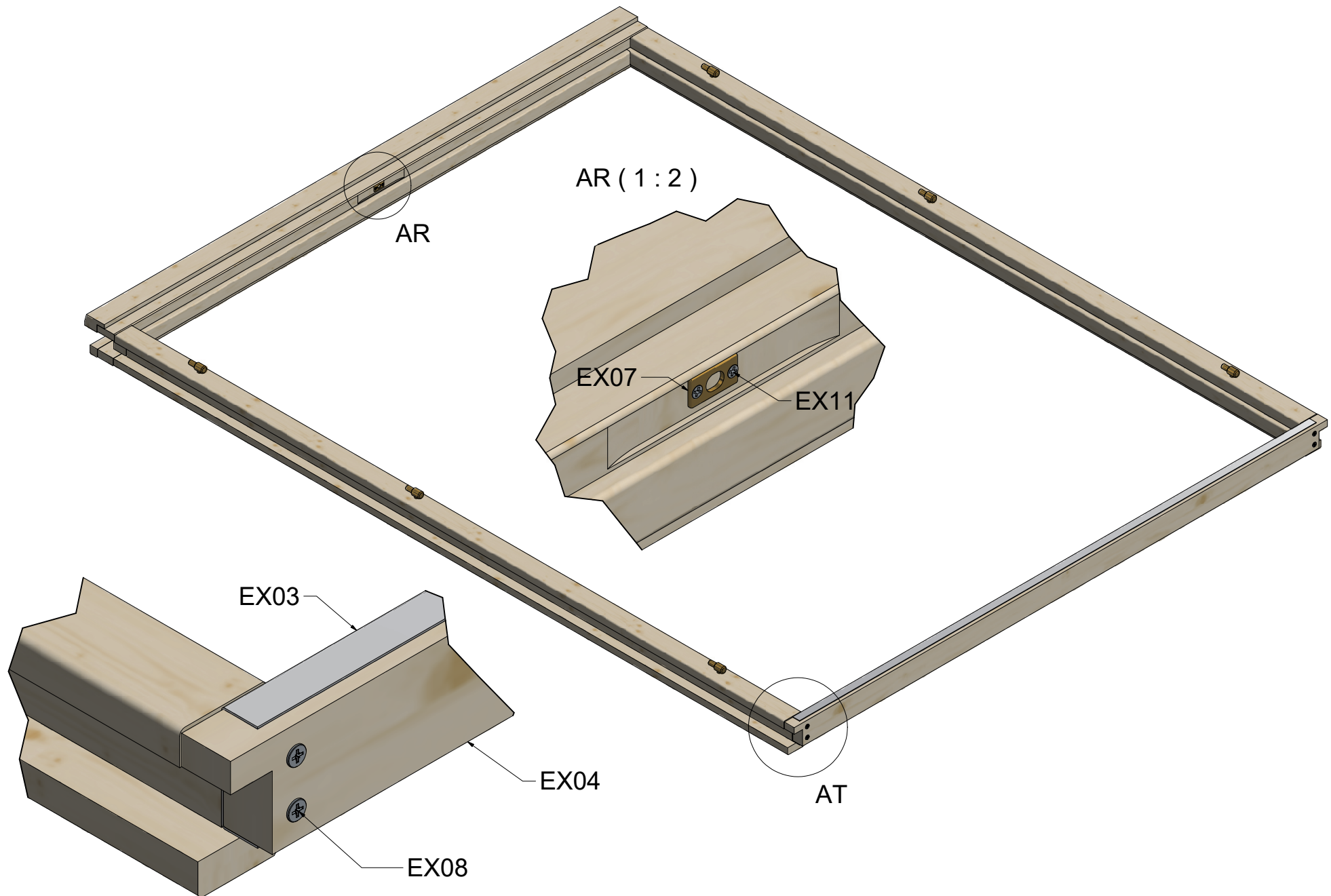

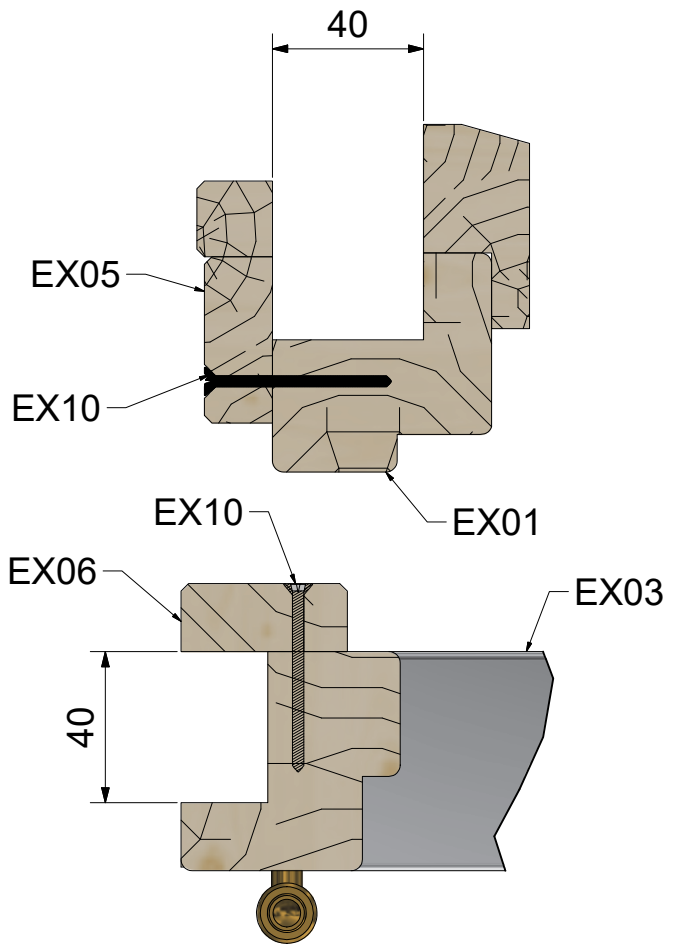
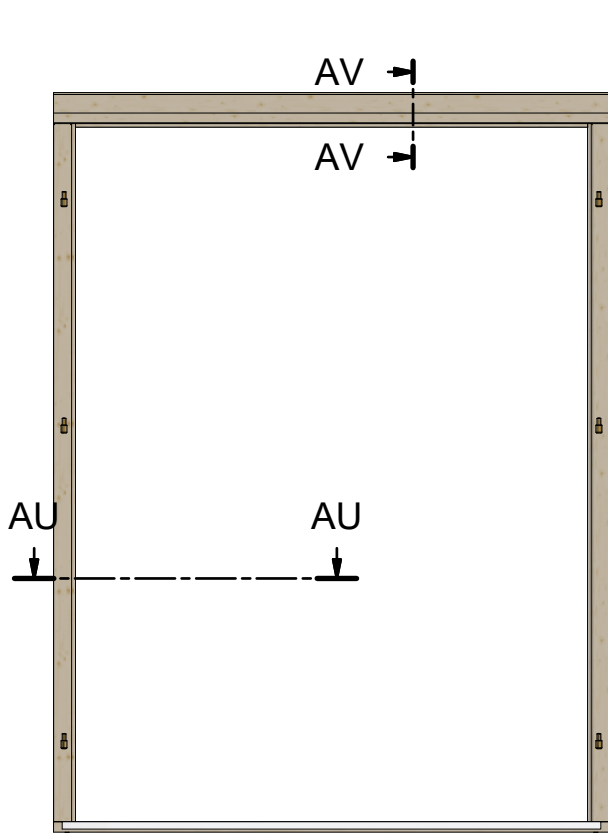

AU-AU ( 1 : 20 )

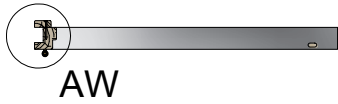

Specification Double Door Frame 28mm

Nr	Description	Profile	Amount
EX01			1
EX02			1+1
EX03			1
EX04			1
EX05			1
EX06			2
EX07			1
EX08	Screws 5,0 x 70		4
EX09	Screws 4,0 x 50		2
EX10	Screws 4,0 x 40		12
EX11	Screws 3,0 x 30		2