

# Installation manual

Montageanleitung • Notice de montage • Istruzioni per il montaggio  
Manual de montaje • Monteringsanvisning • Installatiegids • Asennusohje • Installationsmanual • Paigaldusjuhend

## Element house EL18-4533-5

Elementhaus • Maison à modules • Casetta in elementi • Cobertizo • Redskapsbod • Element huis • Elementti piharakennus • Friggebod • Elementmaja

Width 452 x Depth 330 cm

Breite/Tiefe • Largeur/Profondeur • Lunghezza/Profondità • Ancho/Profundidad • Bredd/Dybde • Breedte/Diepte • Leveys/Pituus • Bredd/Längd • Laius/pikkus









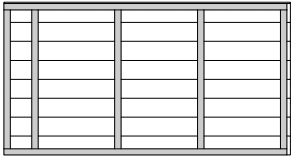
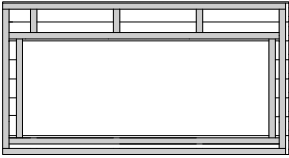
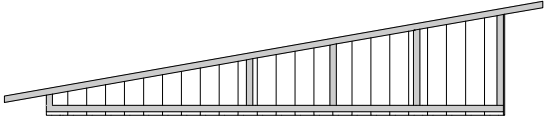
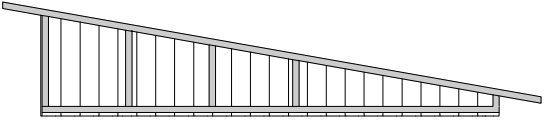
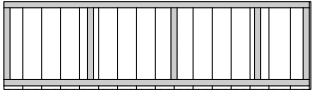
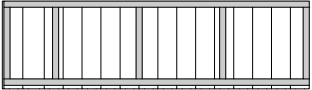
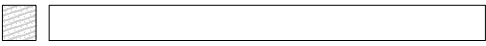
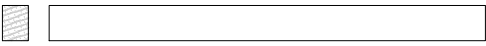
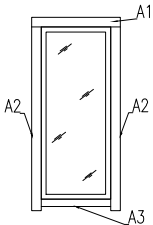

















Log thickness 18 mm

Bohlenstärke • Épaisseur des murs • Spessore delle pareti • Grosor de pared • Tykkelse • Wanddicke • Seinän paksuus • Väggtjocklek • Seinapaksus



The producer shall have the right to make technical changes to the product • Technische Änderungen vorbehalten • Le producteur réserve le droit d'effectuer des modifications techniques au produit • Il produttore mantiene il diritto di apportare modifiche tecniche al prodotto • Reservado el derecho a modificaciones técnicas • Produsent forbeholder seg retten til å endre tekniske egenskaper ved produktet • Alle rechten en technische wijzigingen voorbehouden • Valmistaja pidättää oikeuden tehdä tuotteeseen teknisiä muutoksia • Tillverkaren har rätt att utföra tekniska förändringar för produkten • Tootja jätab endale õiguse muuta toote tehnilisi omadusi

EL1		2055 x 1097 x 88	8
EL2		2055 x 1097 x 88	2
EL3		3849 x 751 x 88	1
EL4		3849 x 751 x 88	1
EL5		2202 x 567 x 88	1
EL6		2192 x 567 x 88	1
P1		2030 x 120 x 120	2
P2		2030 x 120 x 88	1
A105-9	 <p> A1 - 19x70x830 2 pcs  A2 - 19x70x1820 4 pcs  A3 - 19x70x630 2 pcs </p>	660 x 1740 x 105	2

1	 Treated	45 x 145 x 4398	7
2	 Treated	45 x 145 x 3261	2
3		19 x 89 x 3261	51
4		34 x 70 x 4384	1
5		44 x 140 x 3910	7
6		10 x 165 x 576	12
7		10 x 165 x 450	4
8		16 x 120 x 2514	6
9		16 x 95 x 2514	2
10		16 x 45 x 2514	2
11		16 x 120 x 3957	4
12		16 x 95 x 3957	2
13		32 x 40 x 3890	2
14a		19 x 89 x 3095	45
14b		19 x 89 x 1895	45
15		18 x 135 x 2055	4
16		18 x 135 x 545	2
extra		28 x 120 x 2010	2
F1		90 x 90 x 65	14
F2		Ø 6 x 120	34
F3		Ø 4.5 x 70	170
F4		Ø 4 x 50	240
F5		Ø 4 x 40	180
F6		Ø 3 x 70	850
F7		QKA100x150Zn	2
F8		Ø 2.5 x 16	8

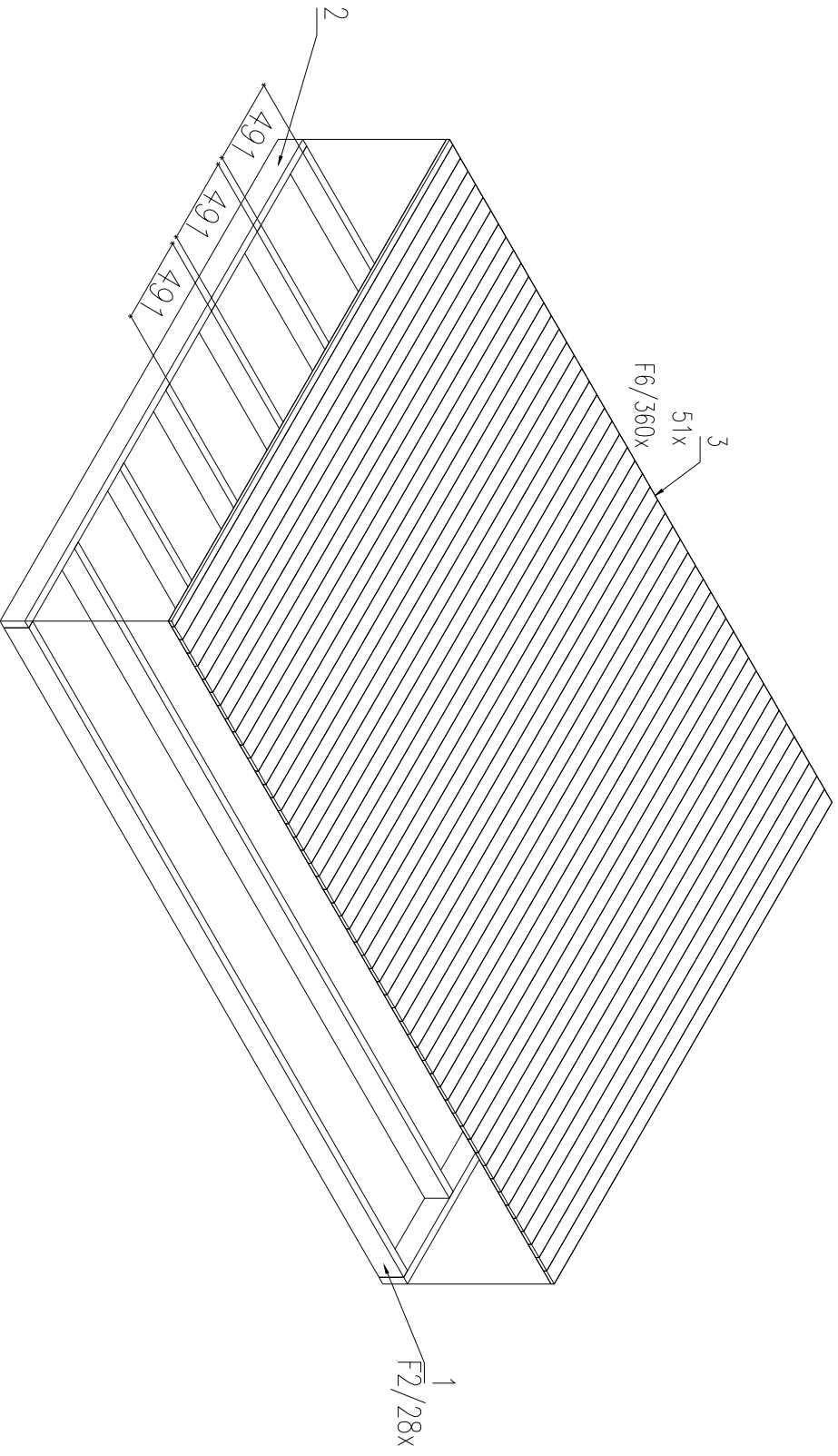

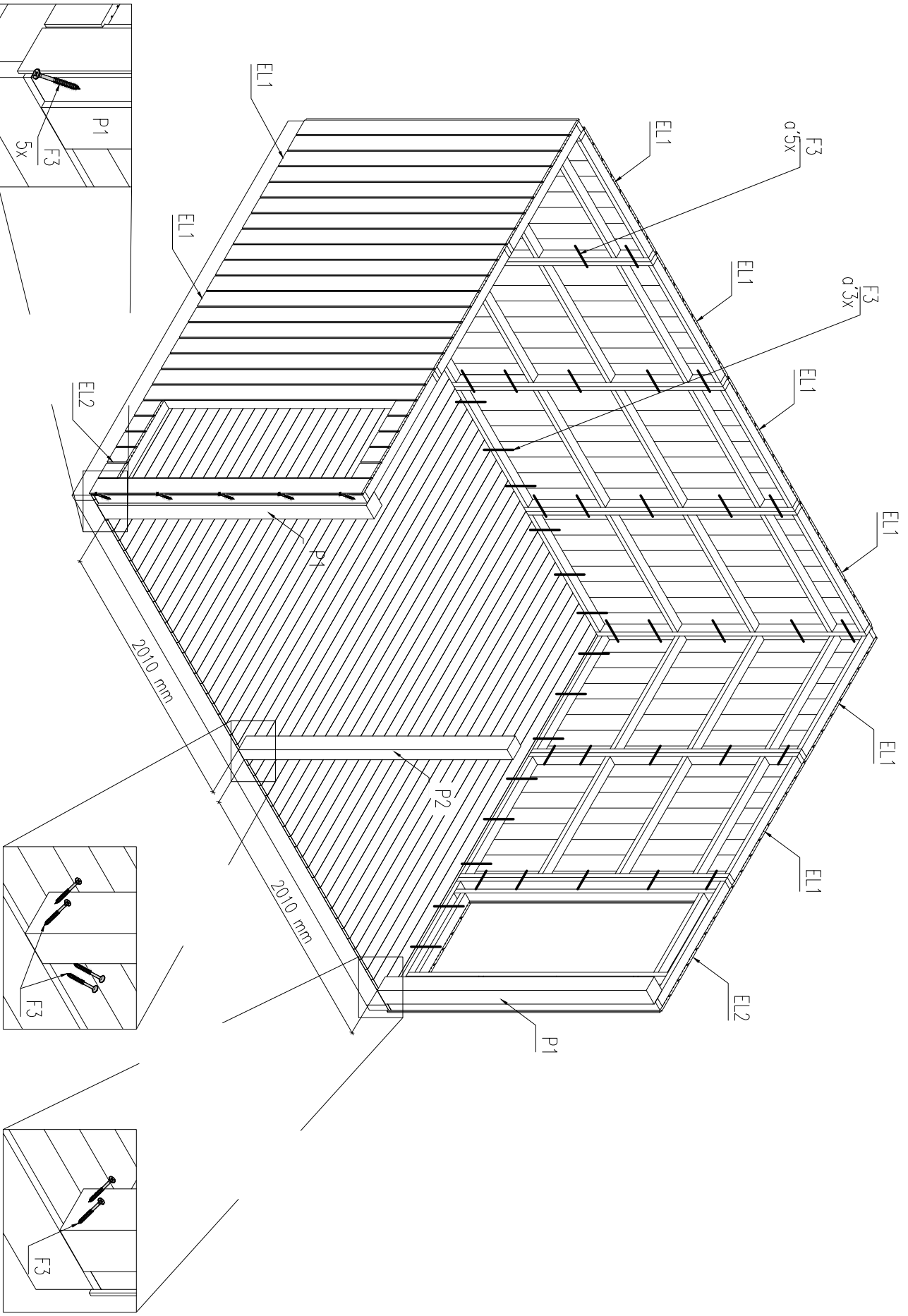

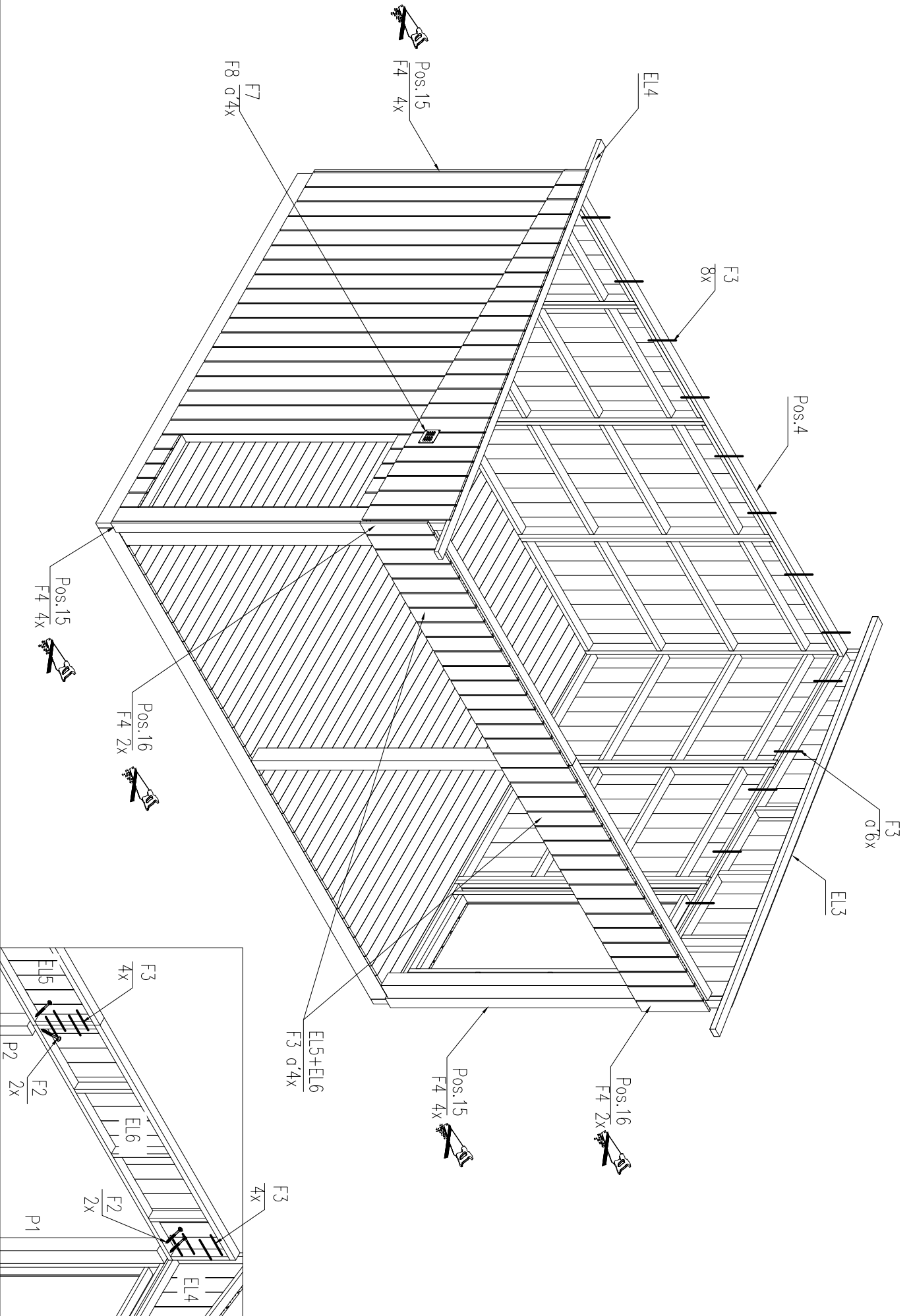

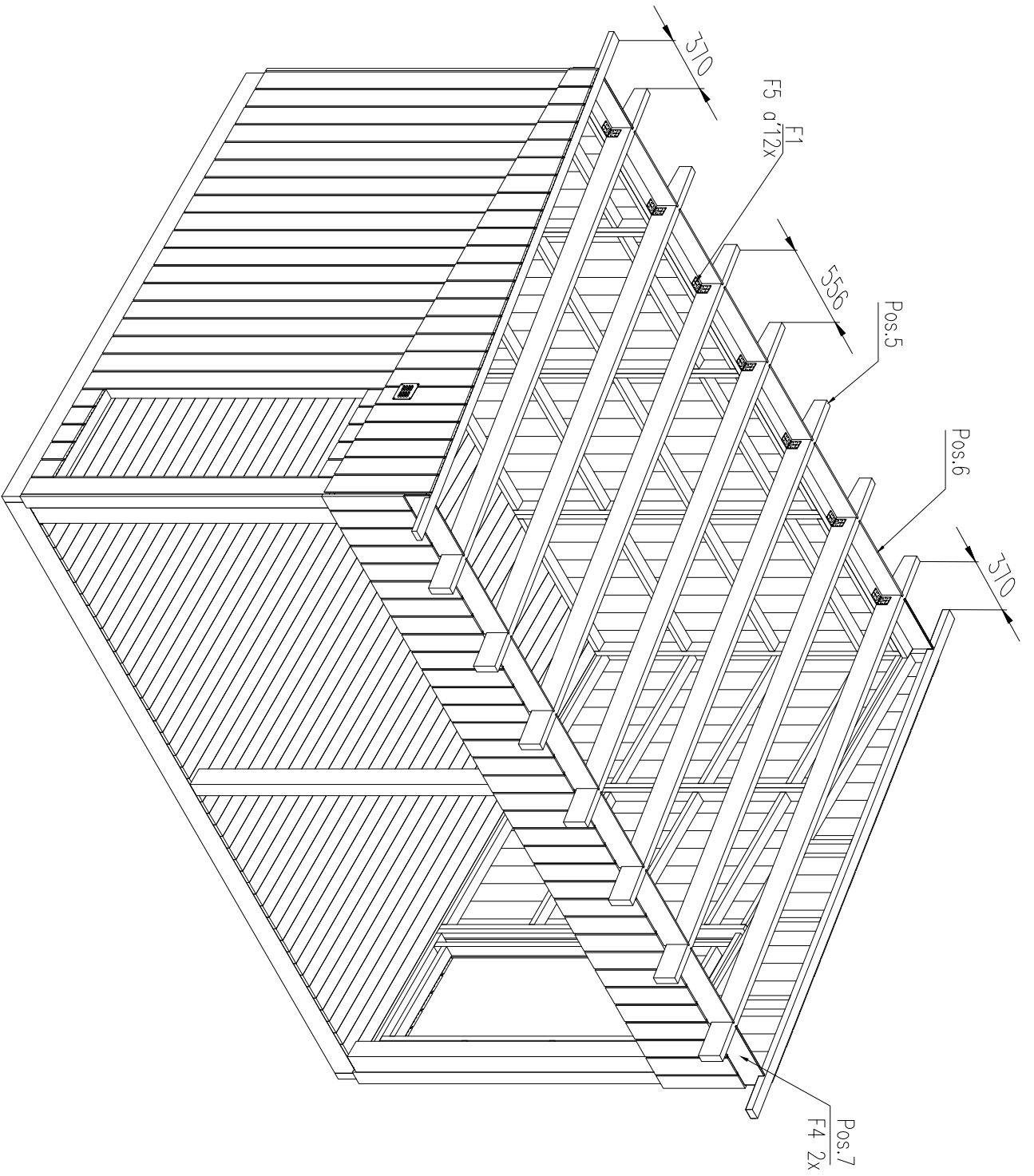

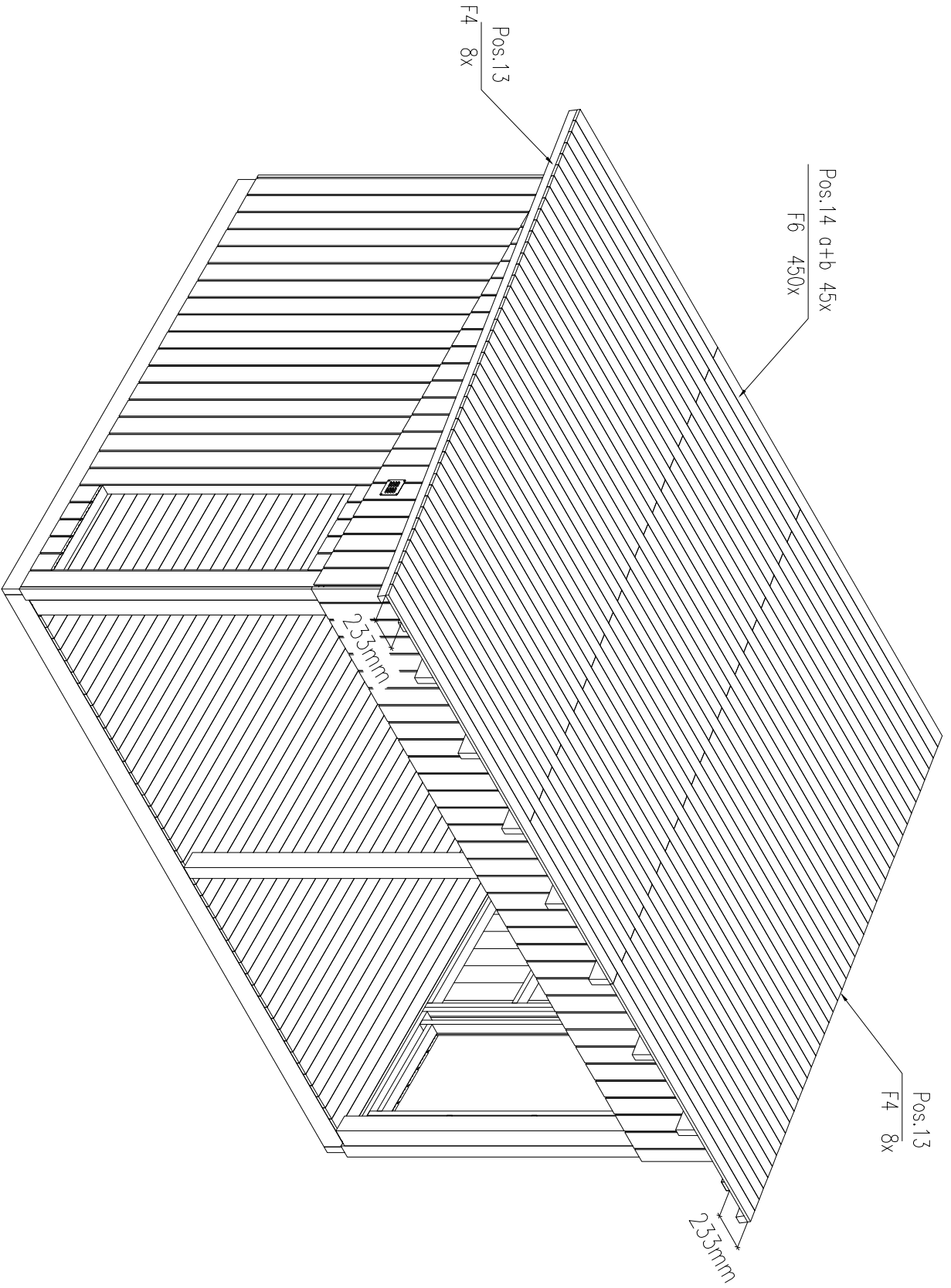



# 6

